

TEM

On | Off and everything in between

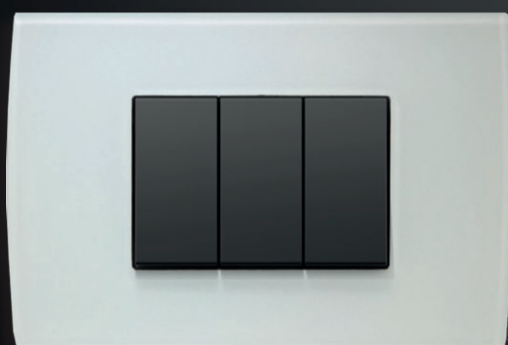

2022

MODUL



MODUL
LINE



MODUL
SOFT



MODUL
PURE

38

LOGIQ



146

ekonomik



176

fontana



214



TEM

On | Off and everything in between



Wir sind der führende Hersteller von Schaltern und Steckdosen in der Region. Wir bieten unseren Kunden seit einem halben Jahrhundert eine positive und problemlose Erfahrung und erfüllen gleichzeitig durch eine einfache Montage und Bedienung der Produkte sowie eine große Auswahl an Farben und Materialien noch so anspruchsvolle Wünsche jedes Kunden und Raums.

We are the leading manufacturer of switches and sockets in the region. For half a century, we have been providing our users a positive and easy experience, simple installation and use of products, a wide range of colours and materials, which convince even the most demanding.

TEM

Willkommen in der Familie **MODUL**

Welcome to the **MODUL** family

Verleihen Sie dem Ambiente eine persönliche Note und unterstreichen Sie Ihren Stil mit Schaltern und Steckdosen aus der MODUL-Familie.

Give your ambience a personal touch and show off your style with switches and sockets from MODUL family.

Wir bieten neue Einblicke

discovering new insights



MODUL

LINE



MODUL

SOFT



MODUL

PURE

1

2

MODUL

LINE



MODUL

SOFT



MODUL

PURE



Metall

Glas

Holz

3

4

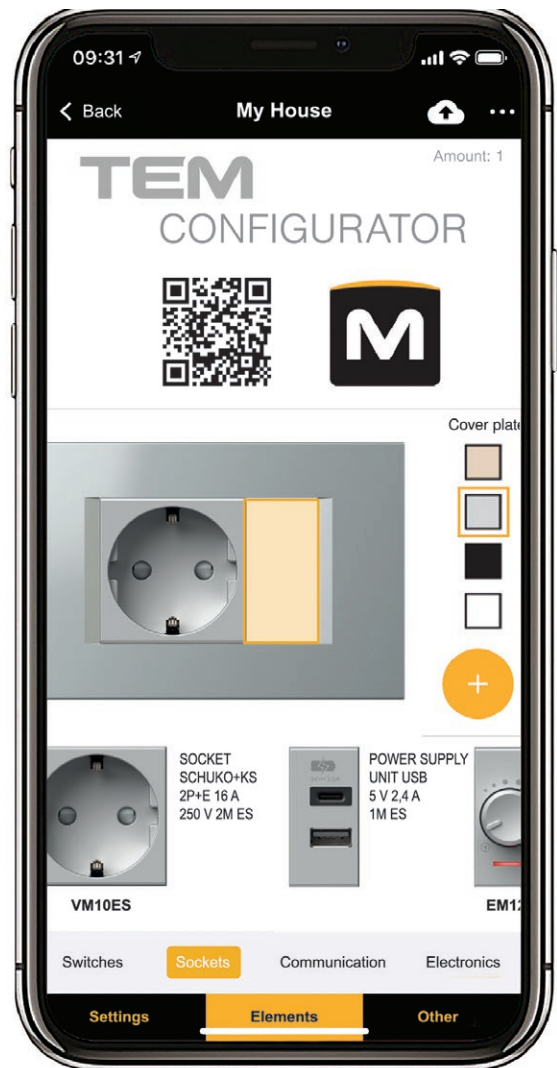
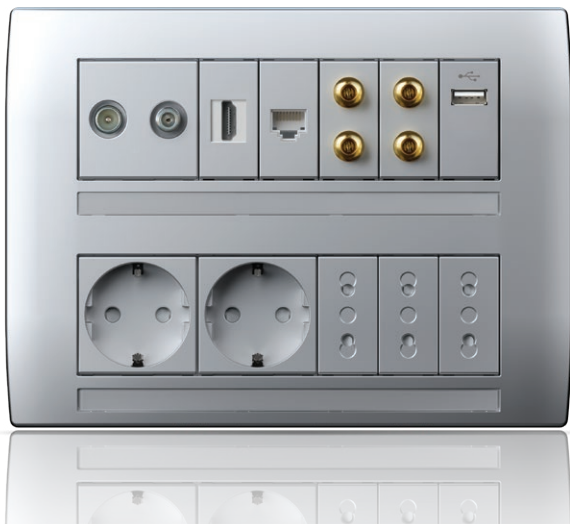

MODUL

LINE



Klare, gerade Linien schaffen ein zeitloses Design.

Straight, smooth lines create a timeless design.





MODUL

LINE

PW

IW

ES

AT

SB

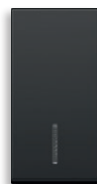

Weiß glänzend

Beige
glänzend

Silber matt

Anthrazit

Schwarz matt

polar white

ivory white

elox silver

anthracite

*soft touch
black*

Wählen Sie Ihre Farbe

Select your colour

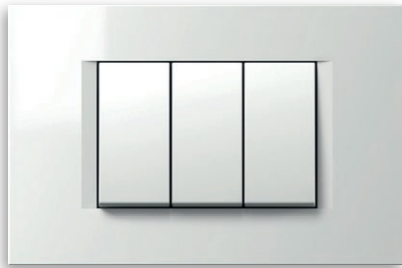

PW Weiß glänzend
polar white

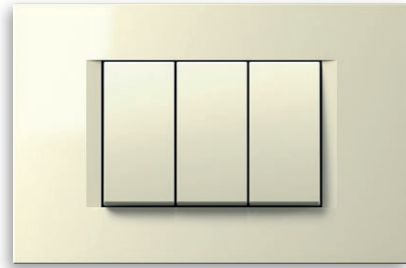

IW Beige glänzend
ivory white



SW Steinweiß
stone white

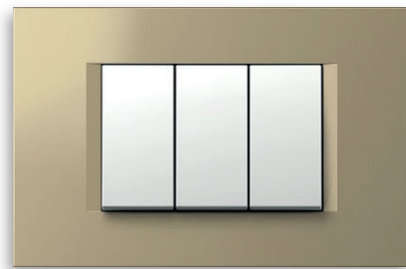

SG Gold matt
sand gold



ES Silber matt
elox silver

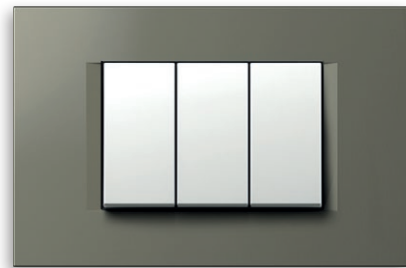

TI Titan
titanium

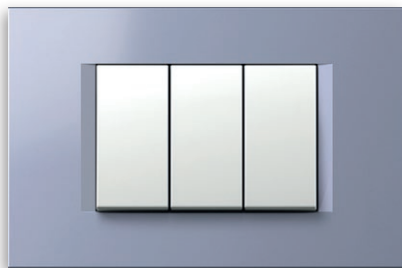

IB Blau matt
impulse blue



AT Anthrazit
anthracite



NB Schwarz glänzend
night black

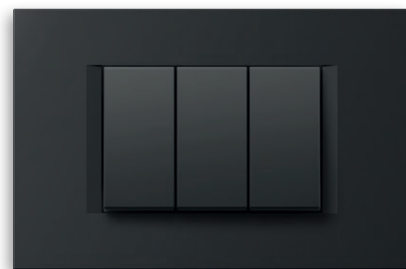

SB Schwarz matt
soft touch black

MODUL

SOFT

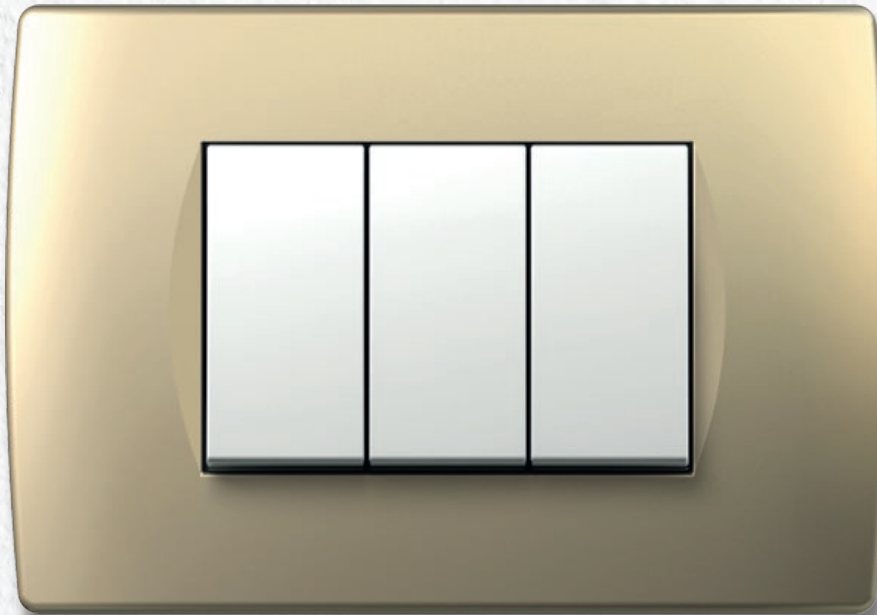

Abgerundete Formen und weiche Übergänge bringen Geschmeidigkeit in
Ihr Zuhause.

Rounded shapes and soft transitions bring softness into your home.





MODUL

SOFT

PW



Weiß glänzend

polar white

IW



Beige glänzend

ivory white

ES



Silber matt

elox silver

AT



Anthrazit

anthracite

SB



Schwarz matt

*soft touch
black*

Wählen Sie Ihre Farbe

Select your colour

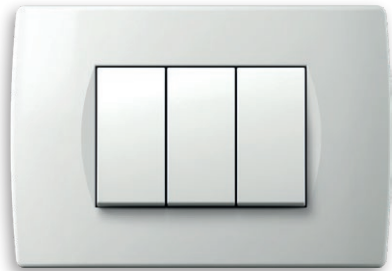

PW Weiß glänzend
polar white

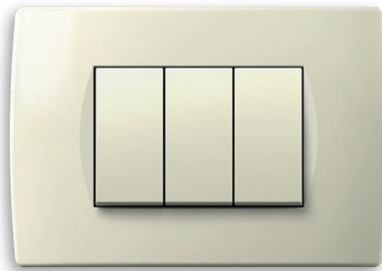

IW Beige glänzend
ivory white



ES Silber matt
elox silver

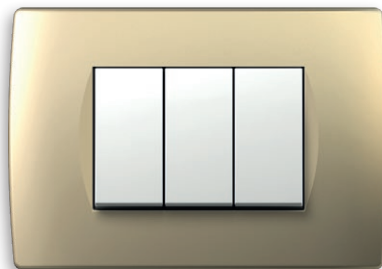

SG Gold matt
sand gold



WW Nuss
walnut

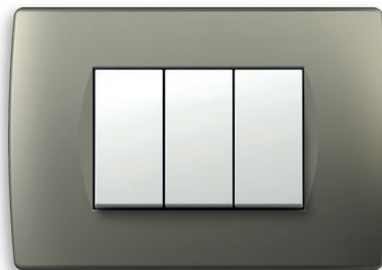

TI Titan
titanium



WE Wenge
wenge



AT Anthrazit
anthracite



NB Schwarz glänzend
night black



SB Schwarz matt
soft touch black

MODUL

PURE

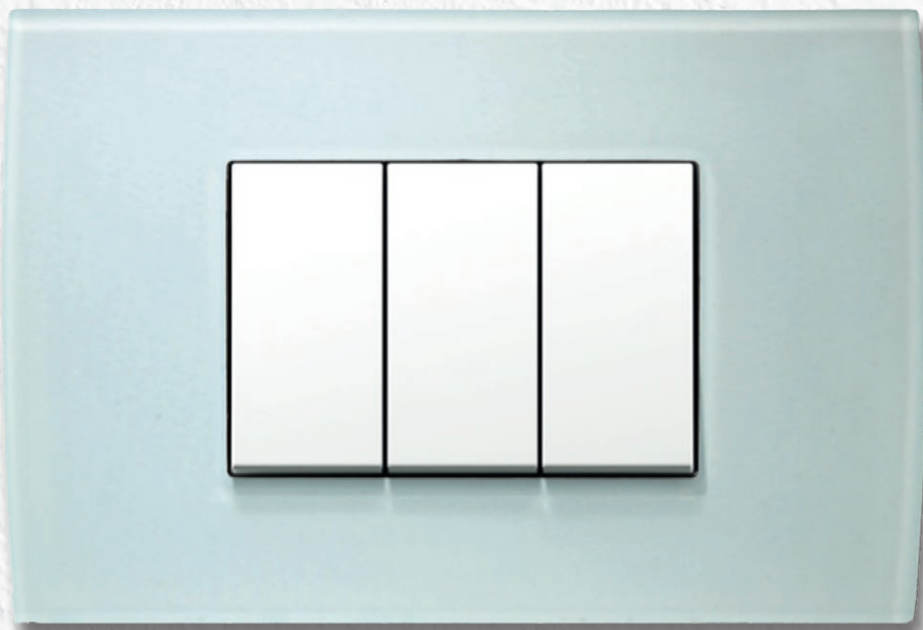

Die Vollkommenheit des Ambientes liegt in den Details. Lassen Sie die Natur Ihren Raum mit dekorativen Rahmen aus Holz, Glas und Metall bereichern.

The details represent the completeness of the entire ambience. Let the nature enrich your space with decorative cover plates made of wood, glass and metal.

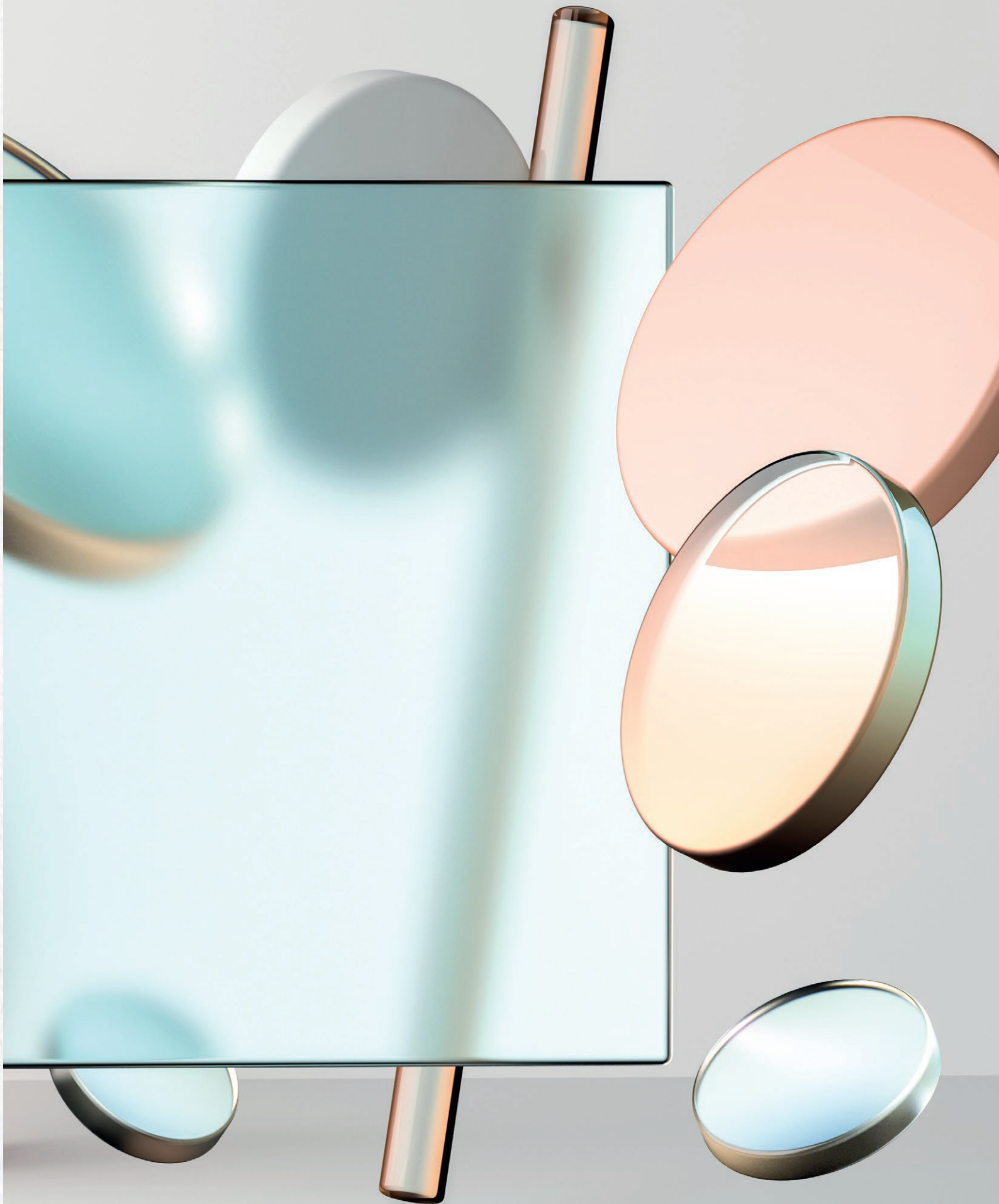



MODUL

PURE

PW



Weiß glänzend

polar white

IW



Beige glänzend

ivory white

ES



Silber matt

elox silver

AT



Anthrazit

anthracite

SB



Schwarz matt

soft touch black

Glas
glass



GW Eisweiß
ice white

Metall
metal



MH geschmiedeter Stahl
hammered steel

Holz
wood



WM Ahorn
maple

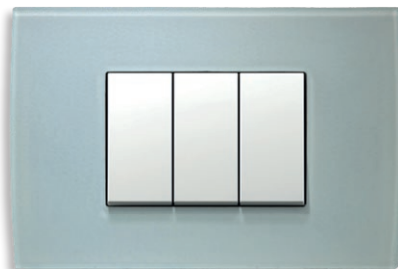

GG Eisgrün
ice green

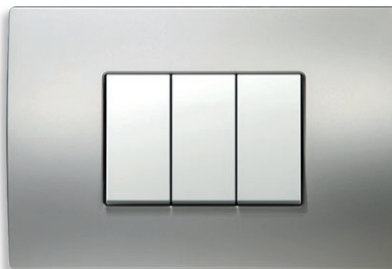

MS Satinsilber
satın silver



WB Bambus
bamboo

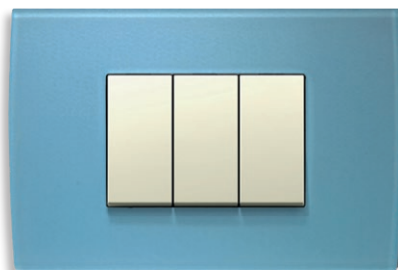

GB Eisblau
ice blue



MN Satin Nickel
satın nickel



WW Nuss
walnut

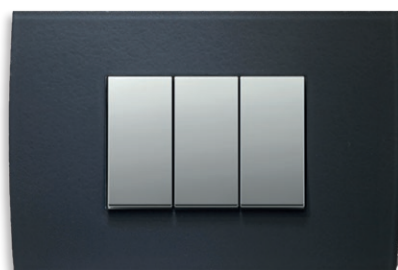

GY Eisgrau
ice grey



ME geätztes Eisen
etched iron



WE Wenge
wenge

MODUL

PURE



GLAS - unbeschwert und raffiniert.
Lassen Sie die Frische in Ihr Zuhause.

*GLASS - light and sophisticated.
Let freshness breeze through your home.*





Glas
glass

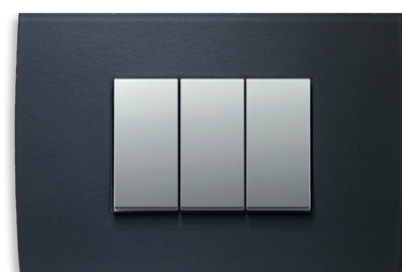
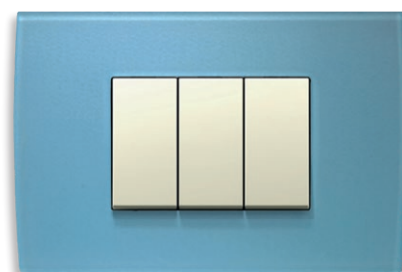
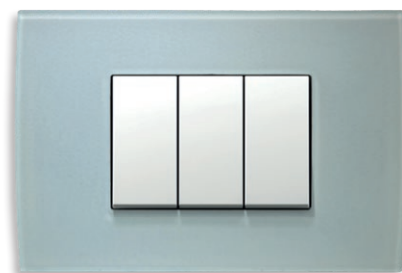

MODUL

PURE



METALL - kalt, aber zugleich edel.
Öffnen Sie die Tür zur Ursprünglichkeit und machen
Sie sich unauffällig bemerkbar.

*METAL - cold, yet noble.
Embrace this pristine material and
effortlessly catch attention.*





Metal
metal

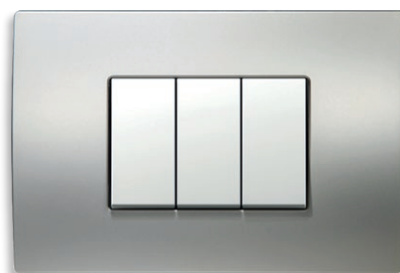

MODUL

PURE



HOLZ – vielfältig und gleichzeitig einzigartig.
Bereiten Sie den Weg für die Wärme der Natur.

*WOOD - versatile, yet unique.
Give way to nature's warmth.*





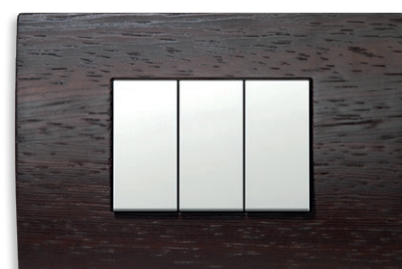

Holz
wood

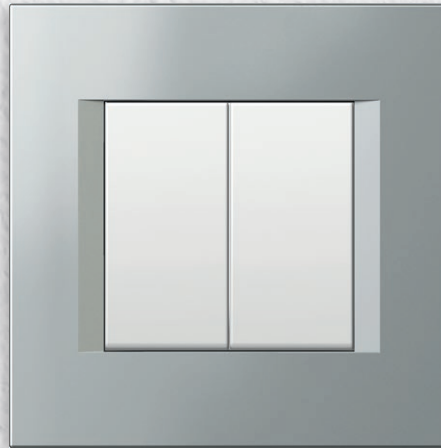



MODUL

-  LINE
-  SOFT
-  PURE



+

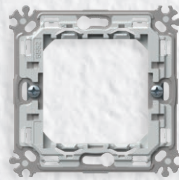

+



2M



2 x 2M



3 x 2M



4 x 2M





5 x 2M

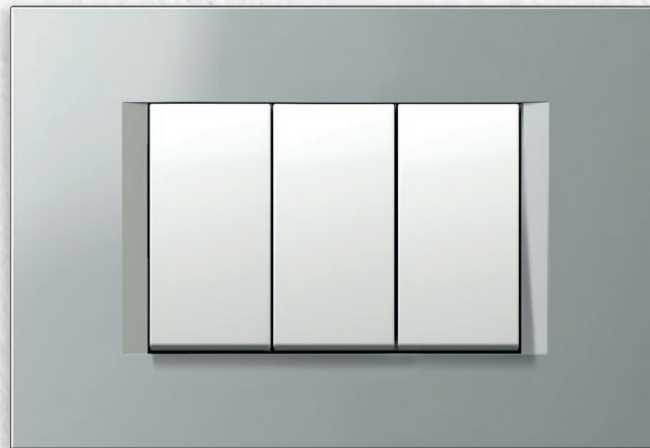



MODUL

-  LINE
-  SOFT
-  PURE



2 x 7M

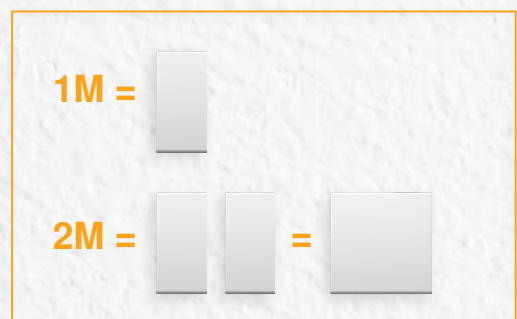

Die Funktionselemente werden ganz einfach an dem Träger befestigt. Für Sie entwickelten wir die „Klick-Ein-Klick-Aus-Lösung“, die wesentlich zur Verkürzung der Montagezeit beiträgt. Die Anschlusskontakte sind von der Vorderseite leicht erreichbar.

The function elements are easily fitted inside the mounting frame.

The “klik-in, klik-out” solution we have developed for you will reduce installation time. The connection contacts are easily accessible from the front.

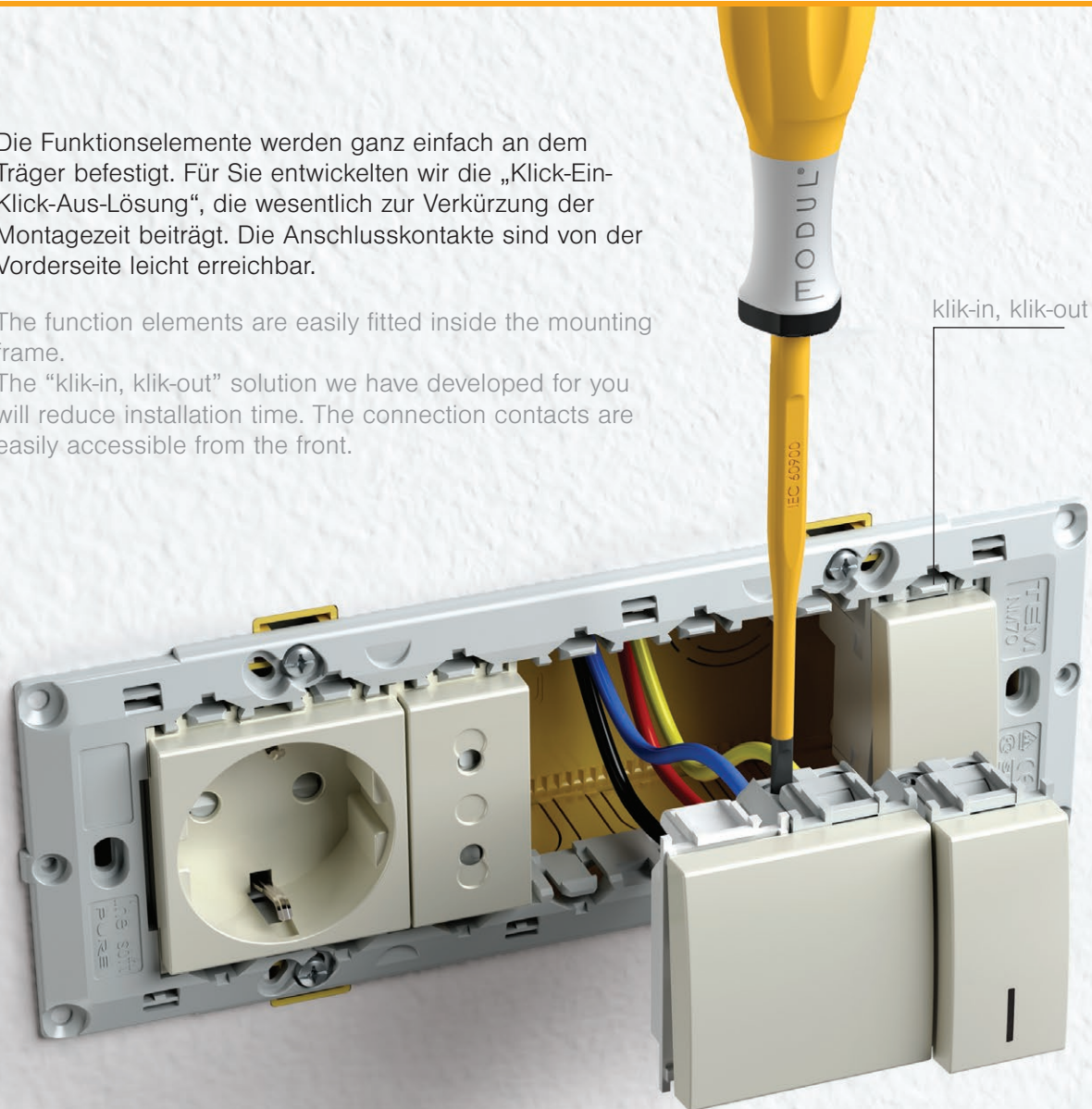

Modul kann in alle Wandarten eingebaut werden, sei dies eine klassische, Trockenbau- oder eine Betonwand. Der Einbau ist einfach und bietet Ihnen die Möglichkeit des Zusammenbaus von runden oder rechteckigen Dosen in beliebigen Abständen.

Die verwendeten Materialien werden nach hohen Normen geprüft.

The Modul is suitable for all wall types and can be used in conventional, hollow wall or concrete constructions. It is easy to install and enables you to combine rectangular or round boxes at the proper distances. The materials used are compliant with high standards.



Ziegelwand / brick



Hohlwand / hollow wall



Betonwand / concrete

Modul bietet Ihnen viele Möglichkeiten auch durch die Verwendung von Runddosen. Sie können horizontal oder vertikal, selbstständig oder im Satz kombiniert werden. Der Metallträger gewährleistet eine hervorragende Stabilität auch bei Grobeinsatz und ist für alle dekorativen Rahmen geeignet.

The Modul enables a many possibilities even with round boxes. You can combine them horizontally or vertically, individually or in groups. The metal mounting frame ensures excellent stability even with rough use and is suitable for any decorative cover plates.

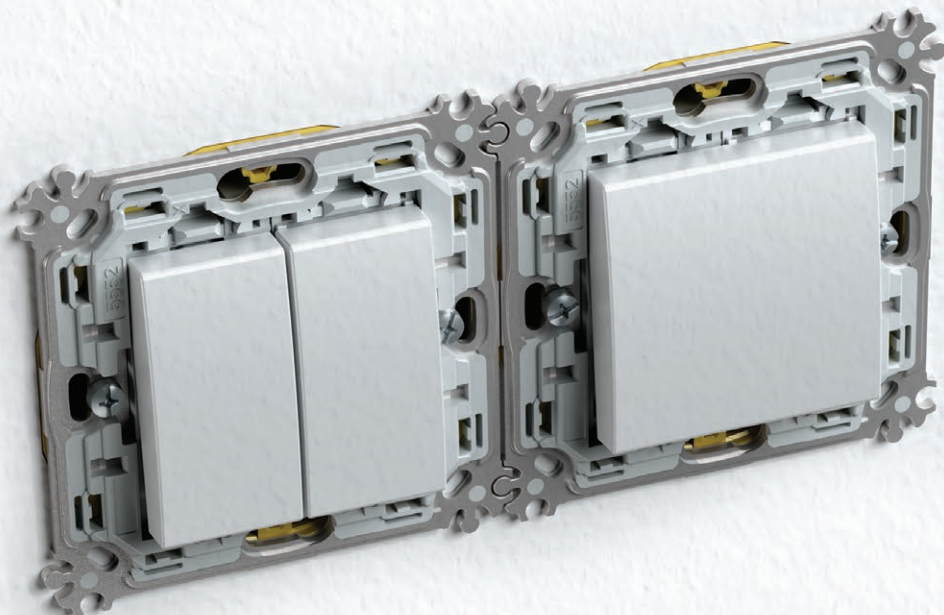



□ PW Weiß glänzend
polar white



■ SB Schwarz matt
soft touch black



■ AT Anthrazit
anthracite



□ ES Silber matt
elox silver



□ IW Beige glänzend
ivory white



GRAPHIKEN
SYMBOLS

01	02	03	04	05	06	07	08	09	10	11	12	20	21	22	23
24	25	26	27	28	29	30	31	32	33	34	35	36	37	38	39
					OFF	ON					AC				
40	41	42	43	44	45	46	47	48							

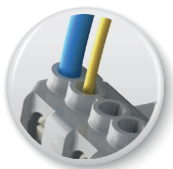
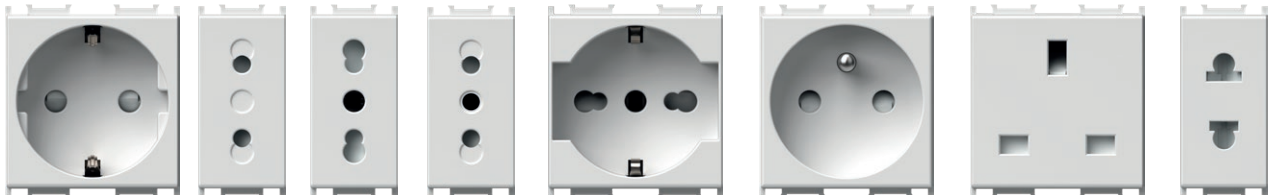

Zuverlässiger und einfacher Anschluss der Leiter in verschiedenen Durchmessern.
Reliable connection even when different size of wires are used.



Alle Steckdosen verfügen über einen Berührungsschutz (Kinderschutz).
All the sockets are equipped with a safety shutters assuring the protection to live contacts.

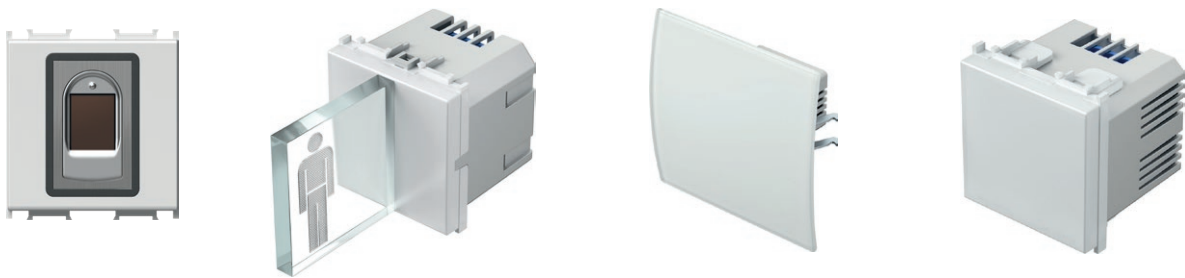
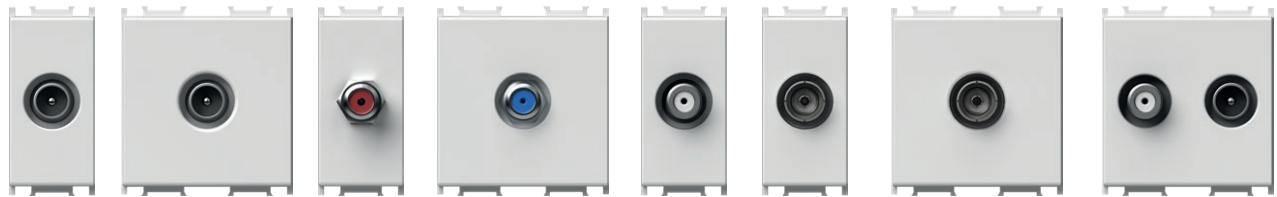
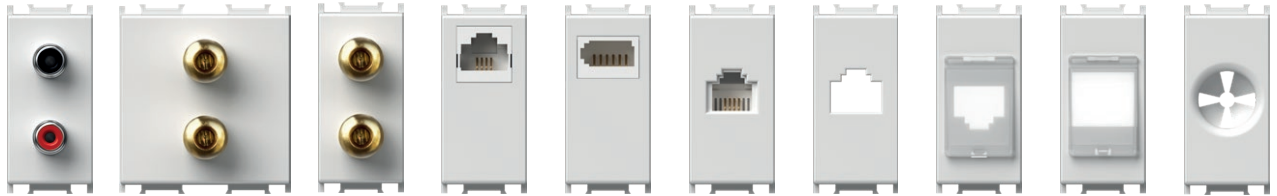

Lange Lebensdauer und Konformität mit aktuellen Normen.
 Long-life of switches and adequacy to the international standards.



Silberne Kontakte garantieren zuverlässiges Schalten.
 The switch is highly reliable via its silver rivets contacts.

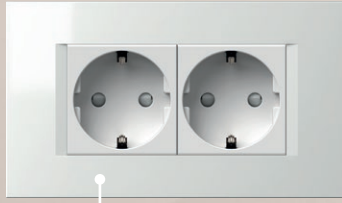



BIOPASS - Fingerabdruckleser

BIOPASS - fingerprint switch

Entriegeln ohne Schlüssel.

Keyless unlocking.

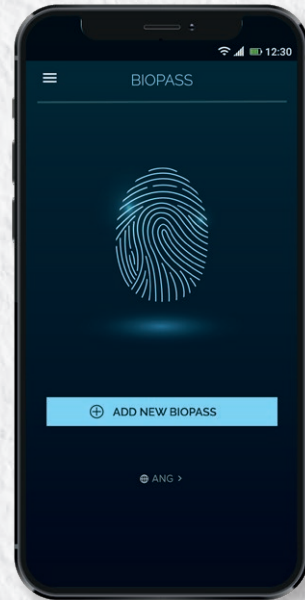

MULTIMEDIA

MULTIMEDIA

Multimediazentrum mit Möglichkeiten zum Anschluss mehrerer verschiedener Komponenten an einer Stelle.

Multimedia center that allows you to connect a multiple number of components in one place.



TOUCH - Universaldimmer

TOUCH - universal dimmer

Bedienen und Dimmen von verschiedenen Glühbirnen und Lampen. Bei größeren Bestellungen fertigen wir Rahmen und Funktionselemente in Ihrer Wunschfarbe.

Switching and dimming of different lamps

KREIEREN SIE IHR EIGENES DESIGN

CREATE YOUR OWN

When ordering large quantities, cover plates and function elements can be made in the colour of your choice.

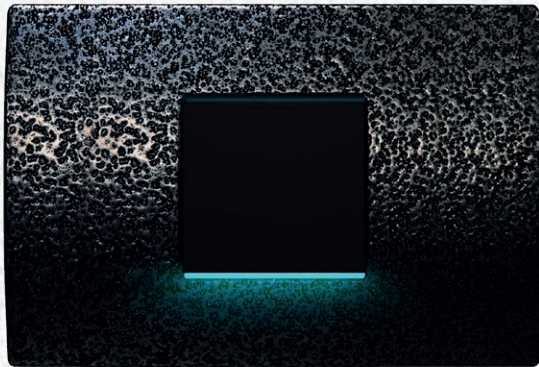

DEKORIEREN SIE AUF IHRE EIGENE WEISE

MAKE IT UNIQUE

Wählen Sie eine Farbe der Beleuchtung und fügen Sie die gewünschten Grafiken dazu, die zu Ihrer Ambiente passen.

Choose a illumination colour and add desired graphic to suit the ambience of your room.



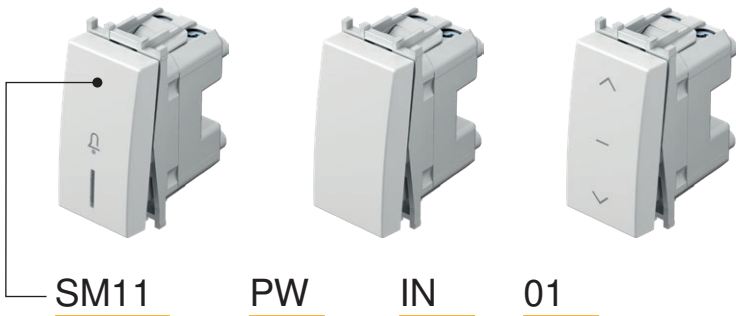

Typ type	Bezeichnung description	Technische Daten technical data	Größe size	Farbe colour	Optionsbezeichnung 1 optional data 1	Optionsbezeichnung 2 optional data 2
SM10	SCHALTER 1-POLIG SWITCH 1WAY	16AX 250V~	1M	<input type="checkbox"/> PW weiß-glänzend polar white	<input type="checkbox"/> NT neutral neutral	01
SM11	TASTER 1-POLIG PUSH BUTTON 1WAY	16A 250V~	1M	<input checked="" type="checkbox"/> SB schwarz-matt soft touch black	<input type="checkbox"/> IN Indikator indicator	02
SM12	SCHALTER 1-POLIG SWITCH 1WAY	20A 250V~	1M	<input checked="" type="checkbox"/> AT anthrazit anthracite		03
⋮	⋮	⋮	⋮	<input type="checkbox"/> ES silber-matt elox silver		
⋮	⋮	⋮	⋮	<input type="checkbox"/> IW beige-glänzend ivory white		

SCHALTER 1-POLIG 16AX 250V~ 1M



SM10

- Schalter ohne Wippe
 - 16AX 250V~, Typ SM10
 - entspricht EN 60669-1
 - Schraubklemmen 1,5--2,5 mm²
- SWITCH 1WAY 16AX 250V~ 1M
- switch without button
 - 16AX 250V~, type SM10
 - in accordance with EN 60669-1
 - screw contacts 1.5-2.5mm²

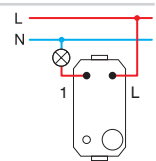
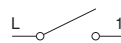

TASTER 1-POLIG 16A 250V~ 1M



SM11

- Taster ohne Wippe
 - 16A 250V~, Typ SM11
 - entspricht EN 60669-1
 - Schraubklemmen 1,5--2,5 mm²
- PUSH BUTTON 1WAY 16A 250V~ 1M
- push button without button
 - 16A 250V~, type SM11
 - in accordance with EN 60669-1
 - screw contacts 1.5-2.5mm²

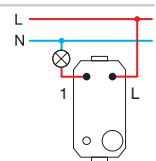

SCHALTER 1-POLIG 20A 250V~ 1M



SM12

- Schalter ohne Wippe
 - 20A 250V~, Typ SM12
 - entspricht EN 60669-1
 - Schraubklemmen 1,5--2,5 mm²
- SWITCH 1WAY 20A 250V~ 1M
- switch without button
 - 20A 250V~, type SM12
 - in accordance with EN 60669-1
 - screw contacts 1.5-2.5mm²

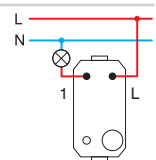
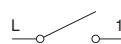

SCHALTER 2-POLIG 16AX 250V~ 1M



SM20

- Schalter ohne Wippe
 - 16AX 250V~, Typ SM20
 - entspricht EN 60669-1
 - Schraubklemmen 1,5--2,5 mm²
 - Nur in Kombination mit Wippe TM15
- SWITCH 2POLE 16AX 250V~ 1M
- switch without button
 - 16AX 250V~, type SM20
 - in accordance with EN 60669-1
 - screw contacts 1.5-2.5mm²
 - only in combination with button TM15

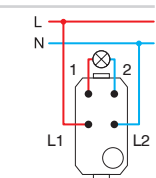
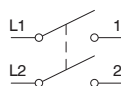

S W I T C H E S S M

SCHALTER JALOUSIE 1-0-2 16AX 250V~ 1M



SM40

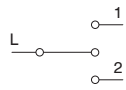

- Schalter ohne Wippe
- 16AX 250V~, Typ SM40
- entspricht EN 60669-1
- Schraubklemmen 1,5–2,5 mm²

SWITCH SHUTTERS 1-0-2 16AX 250V~ 1M

- switch without button
- 16AX 250V~, type SM40
- in accordance with EN 60669-1
- screw contacts 1.5-2.5mm²

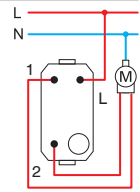

TASTER JALOUSIE 1-0-2 16A 250V~ 1M



SM41

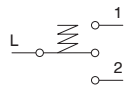

- Taster ohne Wippe
- 16A 250V~, Typ SM41
- entspricht EN 60669-1
- Schraubklemmen 1,5–2,5 mm²

PUSH BUTTON SHUTTERS 1-0-2 16A 250V~ 1M

- push button without button
- 16A 250V~, type SM41
- in accordance with EN 60669-1
- screw contacts 1.5-2.5mm²

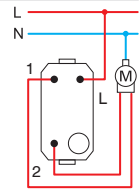

SCHALTER WECHSEL 16AX 250V~ 1M



SM60

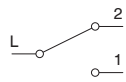

- Schalter ohne Wippe
- 16AX 250V~, Typ SM60
- entspricht EN 60669-1
- Schraubklemmen 1,5–2,5 mm²

SWITCH 2WAY 16AX 250V~ 1M

- switch without button
- 16AX 250V~, type SM60
- in accordance with EN 60669-1
- screw contacts 1.5-2.5mm²

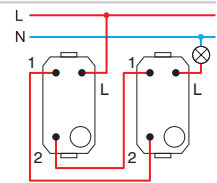

TASTER WECHSEL 16A 250V~ 1M



SM61

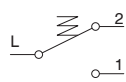

- Taster ohne Wippe
- 16A 250V~, Typ SM61
- entspricht EN 60669-1
- Schraubklemmen 1,5–2,5 mm²

PUSH BUTTON 2WAY 16A 250V~ 1M

- push button without button
- 16A 250V~, type SM61
- in accordance with EN 60669-1
- screw contacts 1.5-2.5mm²

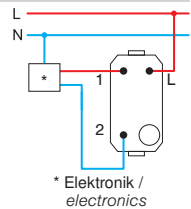

SCHALTER KREUZ 16AX 250V~ 1M



SM70

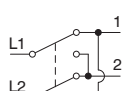

- Schalter ohne Wippe
- 16AX 250V~, Typ SM70
- entspricht EN 60669-1
- Schraubklemmen 1,5–2,5 mm²

SWITCH INTERMEDIATE 16AX 250V~ 1M

- switch without button
- 16AX 250V~, type SM70
- in accordance with EN 60669-1
- screw contacts 1.5-2.5mm²

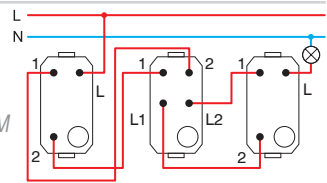

1M = 22,5 x 45
2M = 45 x 45

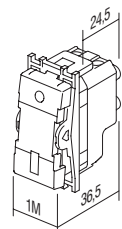
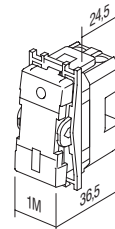



□ PW weiß-glänzend
polar white



■ SB schwarz-matt
soft touch black



■ AT anthrazit
anthracite



□ ES silber-matt
elox silver



□ IW beige-glänzend
ivory white

SCHALTER 1-POLIG 16AX 250V~ 1M



- SM10PW
- SM10SB
- SM10AT
- SM10ES
- SM10IW

- 16AX 250V~, Typ SM10
- entspricht EN 60669-1
- Schraubklemmen 1,5–2,5 mm²
- Wippe auswechselbar

SWITCH 1WAY 16AX 250V~ 1M
- 16AX 250V~, type SM10
- in accordance with EN 60669-1
- screw contacts 1.5-2.5 mm²
- replaceable button



SCHALTER 1-POLIG 16AX 250V~ 1M __ IN



- SM10PWIN
- SM10SBIN
- SM10ATIN
- SM10ESIN
- SM10IWIN

- IN Indikator
- 16AX 250V~, Typ SM10
- entspricht EN 60669-1
- Schraubklemmen 1,5–2,5 mm²
- ohne Glühlampe
- Wippe auswechselbar

SWITCH 1WAY 16AX 250V~ 1M __ IN
- IN indicator
- 16AX 250V~, type SM10
- in accordance with EN 60669-1
- screw contacts 1.5-2.5 mm²
- lamp is not included
- replaceable button



TASTER 1-POLIG 16A 250V~ 1M



- SM11PW
- SM11SB
- SM11AT
- SM11ES
- SM11IW

- 16A 250V~, Typ SM11
- entspricht EN 60669-1
- Schraubklemmen 1,5–2,5 mm²
- Wippe auswechselbar

PUSH BUTTON 1WAY 16A 250V~ 1M
- 16A 250V~, type SM11
- in accordance with EN 60669-1
- screw contacts 1.5-2.5 mm²
- replaceable button



TASTER 1-POLIG 16A 250V~ 1M __ IN 01



- SM11PWIN01
- SM11SBIN01
- SM11ATIN01
- SM11ESIN01
- SM11IWIN01

- IN 01 Indikator Klingel
- 16A 250V~, Typ SM11
- entspricht EN 60669-1
- Schraubklemmen 1,5–2,5 mm²
- ohne Glühlampe
- Wippe auswechselbar

PUSH BUTTON 1WAY 16A 250V~ 1M __ IN 01
- IN 01 indicator bell
- 16A 250V~, type SM11
- in accordance with EN 60669-1
- screw contacts 1.5-2.5 mm²
- lamp is not included
- replaceable button



S W I T C H E S S M

TASTER 1-POLIG 16A 250V~ 1M __ IN 02



- SM11PWIN02 - IN 02 Indikator Licht
- SM11SBIN02 - 16A 250V~, Typ SM11
- SM11ATIN02 - entspricht EN 60669-1
- SM11ESIN02 - Schraubklemmen 1,5-2,5 mm²
- SM11IWIN02 - ohne Glühlampe
- SM11IWIN02 - Wippe auswechselbar

PUSH BUTTON 1WAY 16A 250V~ 1M __ IN 02

- IN 02 indicator light
- 16A 250V~, type SM11
- in accordance with EN 60669-1
- screw contacts 1.5-2.5 mm²
- lamp is not included
- replaceable button



SCHALTER 2-POLIG 16AX 250V~ 1M __ NT 03



- SM20PWNT03 - NT 03 neutral 0-1
- SM20SBNT03 - 16AX 250V~, Typ SM20
- SM20ATNT03 - entspricht EN 60669-1
- SM20ESNT03 - Schraubklemmen 1,5-2,5 mm²
- SM20IWNNT03 - Wippe auswechselbar

SWITCH 2POLE 16AX 250V~ 1M __ NT 03

- NT 03 neutral 0-1
- 16AX 250V~, type SM20
- in accordance with EN 60669-1
- screw contacts 1.5-2.5 mm²
- replaceable button



SCHALTER 2-POLIG 16AX 250V~ 1M __ IN



- SM20PWIN - IN Indikator
- SM20SBIN - 16AX 250V~, Typ SM20
- SM20ATIN - entspricht EN 60669-1
- SM20ESIN - Schraubklemmen 1,5-2,5 mm²
- SM20IWIN - ohne Glühlampe
- SM20IWIN - Wippe auswechselbar

SWITCH 2POLE 16AX 250V~ 1M __ IN

- IN indicator
- 16AX 250V~, type SM20
- in accordance with EN 60669-1
- screw contacts 1.5-2.5 mm²
- lamp is not included
- replaceable button



SCHALTER JALOUSIE 1-0-2 16AX 250V~ 1M __ NT 10

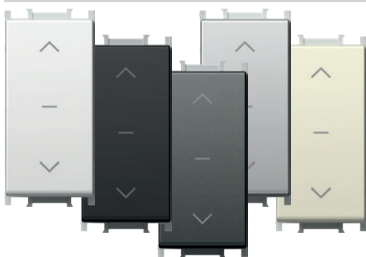

- SM40PWNT10 - NT 10 neutral 1-0-2
- SM40SBNT10 - 16AX 250V~, Typ SM40
- SM40ATNT10 - entspricht EN 60669-1
- SM40ESNT10 - Schraubklemmen 1,5-2,5 mm²
- SM40IWNNT10 - Wippe auswechselbar

SWITCH SHUTTERS 1-0-2 16AX 250V~ 1M __ NT 10

- NT 10 neutral 1-0-2
- 16AX 250V~, type SM40
- in accordance with EN 60669-1
- screw contacts 1.5-2.5mm²
- replaceable button



TASTER JALOUSIE 1-0-2 16A 250V~ 1M __ NT 10

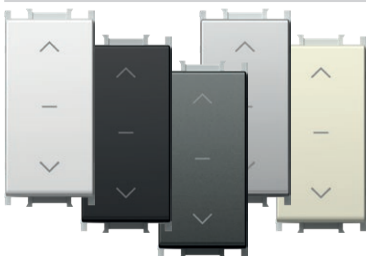

- SM41PWNT10 - NT 10 neutral 1-0-2
- SM41SBNT10 - 16A 250V~, Typ SM41
- SM41ATNT10 - entspricht EN 60669-1
- SM41ESNT10 - Schraubklemmen 1,5-2,5 mm²
- SM41IWNNT10 - Wippe auswechselbar

PUSH BUTTON SHUTTERS 1-0-2 16A 250V~ 1M __ NT 10

- NT 10 neutral 1-0-2
- 16A 250V~, type SM41
- in accordance with EN 60669-1
- screw contacts 1.5-2.5mm²
- replaceable button



SCHALTER WECHSEL 16AX 250V~ 1M



- SM60PW - 16AX 250V~, Typ SM60
- SM60SB - entspricht EN 60669-1
- SM60AT - Schraubklemmen 1,5-2,5 mm²
- SM60ES - Wippe auswechselbar
- SM60IW

SWITCH 2WAY 16AX 250V~ 1M

- 16AX 250V~, type SM60
- in accordance with EN 60669-1
- screw contacts 1.5-2.5 mm²
- replaceable button



TASTER WECHSEL 16A 250V~ 1M



- SM61PW
- SM61SB
- SM61AT
- SM61ES
- SM61IW

- 16A 250V~, Typ SM61
 - entspricht EN 60669-1
 - Schraubklemmen 1,5–2,5 mm²
 - Wippe auswechselbar

PUSH BUTTON 2WAY 16A 250V~ 1M

- 16A 250V~, type SM61
 - in accordance with EN 60669-1
 - screw contacts 1.5-2.5 mm²
 - replaceable button



TASTER WECHSEL MIT SCHNUR 16A 250V~ 1M __ CD



- SM62PWCD
- SM62SBCD
- SM62ATCD
- SM62ESCD
- SM62IWCD

- CD Indikator + Schnur
 - Schnur mit einer Länge von 1,5 m
 - 16A 250V~, Typ SM62
 - entspricht EN 60669-1
 - Schraubklemmen 1,5–2,5 mm²

PUSH BUTTON 2WAY WITH CORD 16A 250V~ 1M __ CD

- CD indicator+cord
 - cord length 1.5m
 - 16A 250V~, type SM62
 - in accordance with EN 60669-1
 - screw contacts 1.5-2.5 mm²



SCHALTER KREUZ 16AX 250V~ 1M



- SM70PW
- SM70SB
- SM70AT
- SM70ES
- SM70IW

- 16AX 250V~, Typ SM70
 - entspricht EN 60669-1
 - Schraubklemmen 1,5–2,5 mm²
 - Wippe auswechselbar

SWITCH INTERMEDIATE 16AX 250V~ 1M

- 16AX 250V~, type SM70
 - in accordance with EN 60669-1
 - screw contacts 1.5-2.5 mm²
 - replaceable button



1M = 22,5 x 45
 2M = 45 x 45

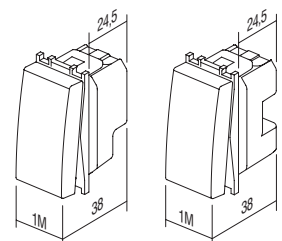

BUTTONS T M

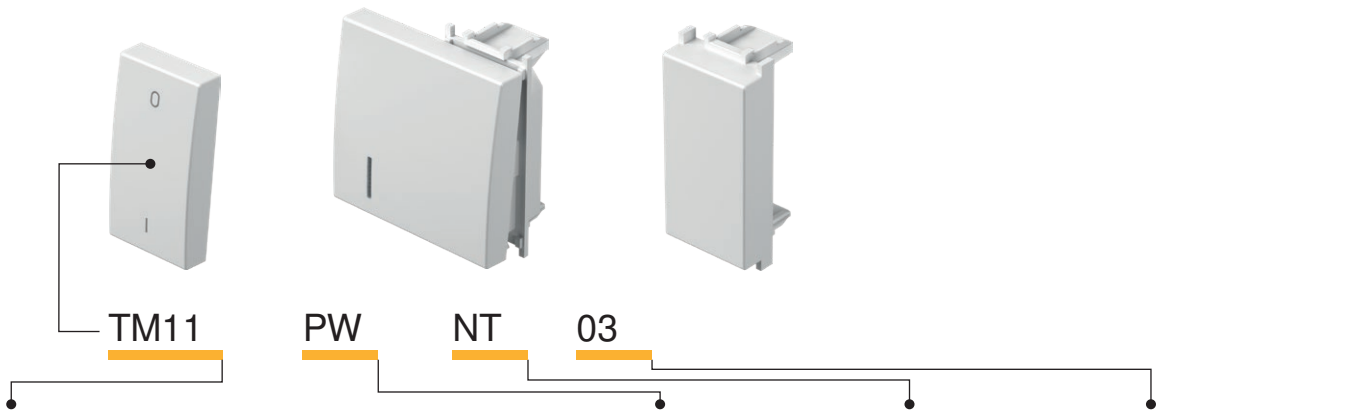

Typ type	Bezeichnung description	Größe size	Farbe colour	Optionsbezeichnung 1 optional data 1	Optionsbezeichnung 2 optional data 2
TM11	WIPPE BUTTON	1M	<input type="checkbox"/> PW weiß-glänzend polar white <input type="checkbox"/> SB schwarz-matt soft touch black <input type="checkbox"/> AT anthrazit anthracite <input type="checkbox"/> ES silber-matt elox silver <input type="checkbox"/> IW beige-glänzend ivory white	NT neutral neutral IN Indikator indicator	01 02 03
TM12	WIPPE BUTTON	2M			
TM21	BLLENDE BLANK	1M			
:	:	:			
:	:	:			

WIPPE 1M

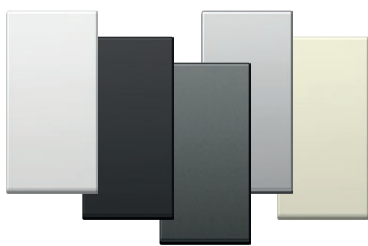

- TM11PW
- TM11SB
- TM11AT
- TM11ES
- TM11IW

- Wippe auswechselbar, Breite 1M
- entspricht EN 60669-1
BUTTON 1M
- replaceable button 1M
- in accordance with EN 60669-1



WIPPE MIT INDIKATOR 1M



- TM11PWIN
- TM11SBIN
- TM11ATIN
- TM11ESIN
- TM11IWIN

- Wippe auswechselbar, Breite 1M
- entspricht EN 60669-1
BUTTON 1M INDICATOR
- replaceable button 1M
- in accordance with EN 60669-1



WIPPE 2M

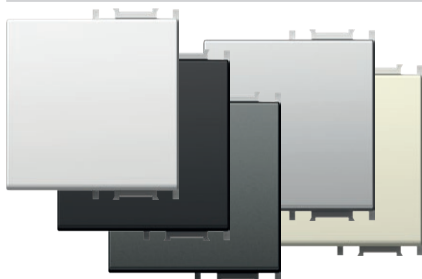

- TM12PW
- TM12SB
- TM12AT
- TM12ES
- TM12IW

- Wippe auswechselbar, Breite 2M mit Wippenträger
- zur Erweiterung von Schaltern oder Tastern in Breite 1M auf Breite 2M
- entspricht EN 60669-1
BUTTON 2M
- replaceable button 2M with button carrier
- to upgrade switch or push button from size 1M to size 2M
- in accordance with EN 60669-1



WIPPE MIT INDIKATOR 2M

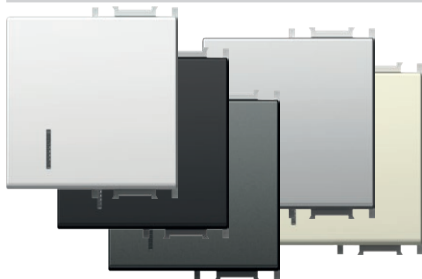

- TM12PWIN
- TM12SBIN
- TM12ATIN
- TM12ESIN
- TM12IWIN

- Wippe auswechselbar, Breite 2M mit Wippenträger
- zur Erweiterung von Schaltern oder Tastern in Breite 1M auf Breite 2M
- entspricht EN 60669-1
BUTTON 2M INDICATOR
- replaceable button 2M with button carrier
- to upgrade switch or push button from size 1M to size 2M
- in accordance with EN 60669-1



WIPPE 2M MIT NAMENSSCHIELD

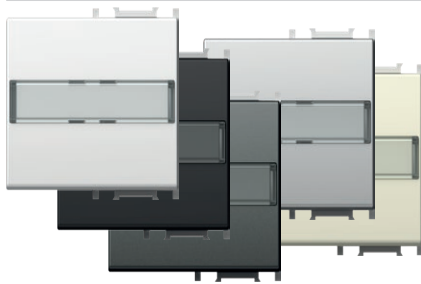

- TM13PWIL
- TM13SBIL
- TM13ATIL
- TM13ESIL
- TM13IWIL

- Wippe auswechselbar, Breite 2M mit Wippenträger
 - zur Erweiterung von Schaltern oder Tastern in Breite
 1M auf Breite 2M
 - entspricht EN 60669-1

BUTTON 2M WITH INSCRIPTION PLATE
 - replaceable button 2M with button carrier
 - to upgrade switch or push button
 from size 1M to size 2M
 - in accordance with EN 60669-1



WIPPE 1M 2-POLIG

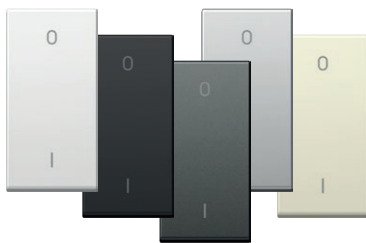

- TM15PW
- TM15SB
- TM15AT
- TM15ES
- TM15IW

- Wippe auswechselbar, Breite 1M
 - nur in Kombination mit SM20
 - entspricht EN 60669-1

BUTTON 1M 2POLE
 - replaceable button 1M
 - only in combination with mechanism SM20
 - in accordance with EN 60669-1



BLENDE 1M

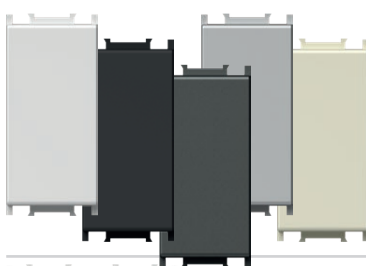

- TM21PW
- TM21SB
- TM21AT
- TM21ES
- TM21IW

- zur Ausfüllung von leeren Stellen
 - entspricht EN 60669-1

BLANK 1M
 - blank modul to fill up empty spaces
 - in accordance with EN 60669-1



BLENDE 2M



- TM22PW
- TM22SB
- TM22AT
- TM22ES
- TM22IW

- zur Ausfüllung von leeren Stellen
 - entspricht EN 60669-1

BLANK 2M
 - blank modul to fill up empty spaces
 - in accordance with EN 60669-1



KABELEINFÜHRUNG 1M

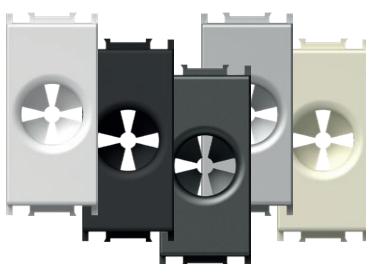

- TM31PW
- TM31SB
- TM31AT
- TM31ES
- TM31IW

- Einführung für Kabel
 - entspricht EN-60669-1

CABLE OUTLET 1M
 - outlet for cable
 - in accordance with EN-60669-1



1M = 22,5 x 45
 2M = 45 x 45

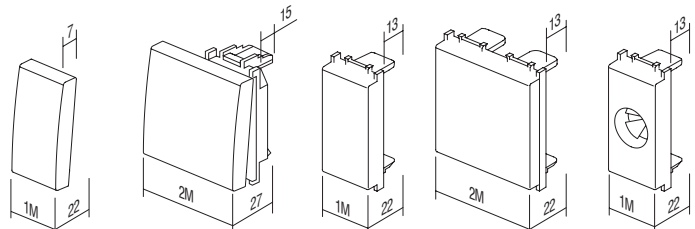

TM11
TM15

TM12
TM13

TM21

TM22

TM31

BUTTONS T M

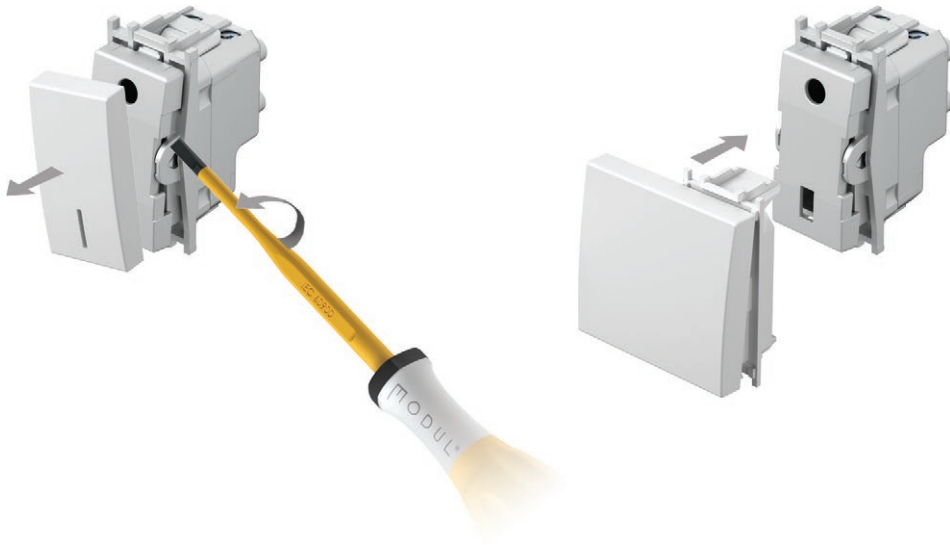

LASERDRUCK AUF WIPPEN

- Laserdruck von beliebigen Symbolen auf gekennzeichnete Stellen
- Standardsymbole auf Lager, andere nach Bestellung

LASER PRINT ON BUTTONS

- laser print of any graphics on marked locations
- standard symbols from stock, other on request

1M

A
B
C

2M

A	D	G
B	E	H
C	F	I

GRAPHIKEN

SYMBOLS

01	02	03	04	05	06	07	08	09	10	11	12	20	21	22	23
24	25	26	27	28	29	30	31	32	33	34	35	36	37	38	39
					OFF	ON					AC				
40	41	42	43	44	45	46	47	48							

STANDARDGRAPHIKEN

STANDARD SYMBOLS

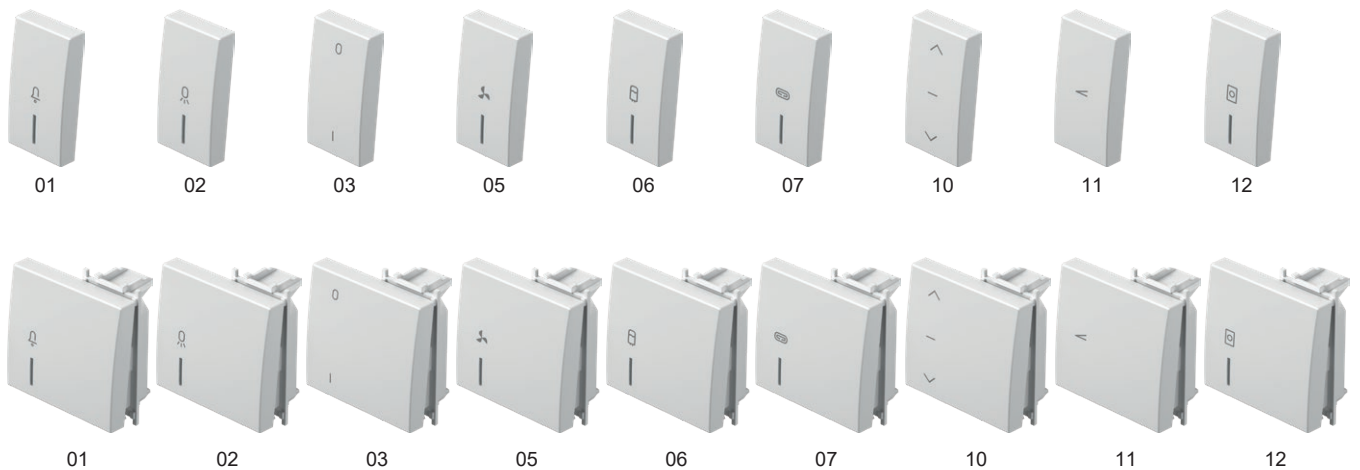

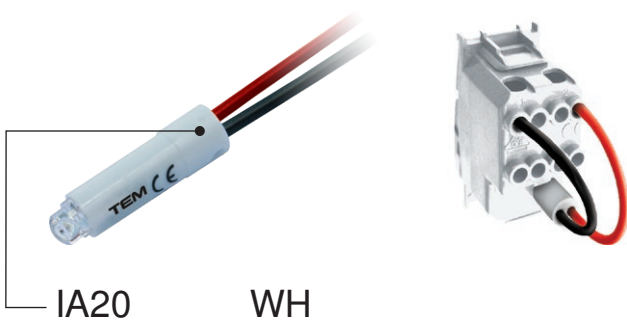

Typ type	Bezeichnung description	Technische Daten technical data	Farbe colour
IA10	GLÜHLAMPE NEON LAMP	230V~ 0,34W	<input type="checkbox"/> WH weiß white
IA20	LED-LAMPE LED LAMP	230V~ AC/DC 0,40W	<input checked="" type="checkbox"/> BL blau blue
IA21	LED-LAMPE LED LAMP	24V AC/DC 0,20W	<input checked="" type="checkbox"/> RD rot red
·	·	·	<input checked="" type="checkbox"/> GR grün green
·	·	·	<input checked="" type="checkbox"/> OR orange orange

GLÜHLAMPE 230V~ 0,34 W

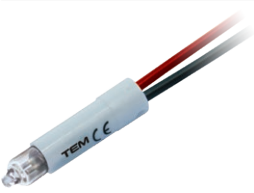

IA10OR

- zur Kontrollbeleuchtung, Beleuchtung oder ständige Beleuchtung des Schalters
- in Kombination mit Wippe mit einem Indikator

NEON LAMP 230V~ 0,34W

- for indication, illumination or constant illumination of switch
- in combination with button with indicator

LED-LAMPE 230V AC/DC 0,40 W

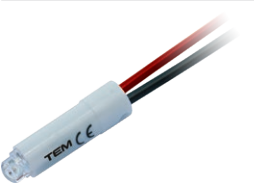

- IA20WH
- IA20GR
- IA20RD
- IA20BL

- zur Kontrollbeleuchtung, Beleuchtung oder ständige Beleuchtung des Schalters
- in Kombination mit Wippe mit einem Indikator

LED LAMP 230V AC/DC 0,40W

- for indication, illumination or constant illumination of switch
- in combination with button with indicator

LED-LAMPE 24V AC/DC 0,20W



- IA21WH
- IA21RD

- zur Kontrollbeleuchtung, Beleuchtung oder ständige Beleuchtung des Schalters
- in Kombination mit Wippe mit einem Indikator

LED LAMP 24V AC/DC 0,20W

- for indication, illumination or constant illumination of switch
- in combination with button with indicator

LED-LAMPE 12V AC/DC 0,10W



- IA22WH
- IA22RD

- zur Kontrollbeleuchtung, Beleuchtung oder ständige Beleuchtung des Schalters
- in Kombination mit Wippe mit einem Indikator

LED LAMP 12V AC/DC 0,10W

- for indication, illumination or constant illumination of switch
- in combination with button with indicator

RC-SCHALTUNG 250V~



IA50

- RC- Schaltung für Störungsbehebung beim Betrieb von LED- Lampen -mehrere RC
- Schaltungen können mit den Lampen verbunden werden
- 0,1 µF, 100 Ω, 250V~

RC CIRCUIT 250V~

- RC circuit to eliminate disturbances in the operation of LED lamps
- parallel connections of more RC circuits with lamps are possible
- 0,1 µF, 100 Ω, 250V~

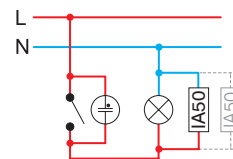

Kontrollbeleuchtung /
Indication

* Beleuchtung /
Illumination

Ständige Beleuchtung /
Constant illumination

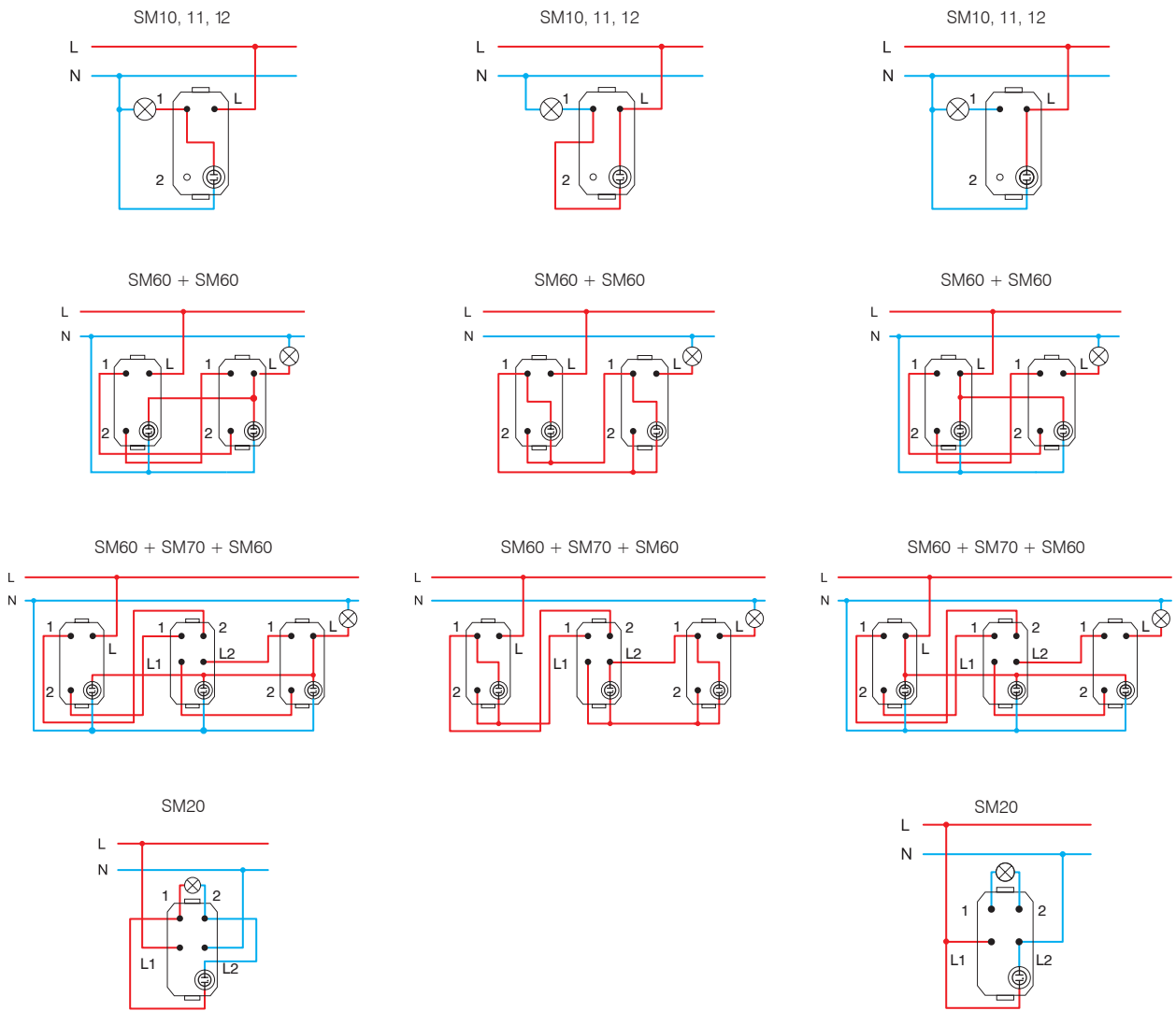

* die Schaltungen sind nicht geeignet für Sparlampen (CFL, LED) /
the connections are not suitable for energy-saving bulbs (CFL, LED)

1M = 22,5 x 45
2M = 45 x 45

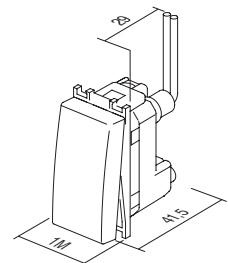

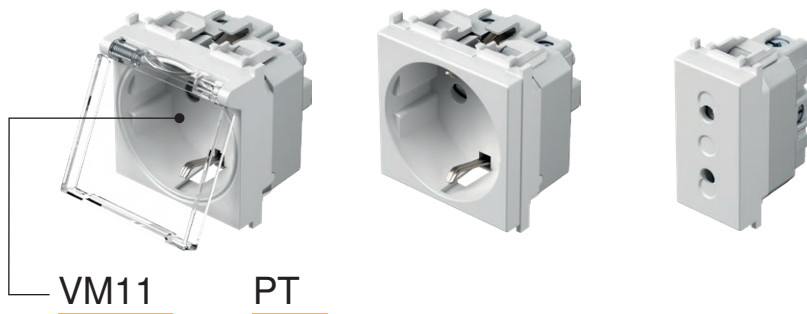

Typ type	Bezeichnung description	Technische Daten technical data	Größe size	Farbe colour																																				
VM10	STECKDOSE SCHUKO+KS SOCKET SCHUKO+KS	2P+E 16A 250V~	2M	<table border="0"> <tr> <td><input type="checkbox"/> PW</td> <td>weiß-glänzend polar white</td> <td><input checked="" type="checkbox"/> PT</td> <td>weiß + transparent white+transparent</td> <td><input type="checkbox"/> PP</td> <td>weiß + weiß white+white</td> </tr> </table>	<input type="checkbox"/> PW	weiß-glänzend polar white	<input checked="" type="checkbox"/> PT	weiß + transparent white+transparent	<input type="checkbox"/> PP	weiß + weiß white+white																														
<input type="checkbox"/> PW	weiß-glänzend polar white	<input checked="" type="checkbox"/> PT	weiß + transparent white+transparent	<input type="checkbox"/> PP	weiß + weiß white+white																																			
VM11	STECKDOSE SCHUKO+KS+KLAPPDECKEL SOCKET SCHUKO+KS+COVER	2P+E 16A 250V~	2M	<table border="0"> <tr> <td><input checked="" type="checkbox"/> SB</td> <td>schwarz-matt soft touch black</td> <td><input checked="" type="checkbox"/> BT</td> <td>schwarz + transparent black+transparent</td> <td><input checked="" type="checkbox"/> BB</td> <td>schwarz + schwarz black+black</td> </tr> </table>	<input checked="" type="checkbox"/> SB	schwarz-matt soft touch black	<input checked="" type="checkbox"/> BT	schwarz + transparent black+transparent	<input checked="" type="checkbox"/> BB	schwarz + schwarz black+black																														
<input checked="" type="checkbox"/> SB	schwarz-matt soft touch black	<input checked="" type="checkbox"/> BT	schwarz + transparent black+transparent	<input checked="" type="checkbox"/> BB	schwarz + schwarz black+black																																			
VM20	STECKDOSE EURO+KS SOCKET EURO+KS	2P 10A 250V~	1M	<table border="0"> <tr> <td><input checked="" type="checkbox"/> AT</td> <td>anthrazit anthracite</td> <td><input checked="" type="checkbox"/> AT</td> <td>anthrazit+transparent anthracite+transparent</td> <td><input checked="" type="checkbox"/> AA</td> <td>anthrazit+anthrazit anthracite+anthracite</td> </tr> <tr> <td><input type="checkbox"/> ES</td> <td>silber-matt elox silver</td> <td><input checked="" type="checkbox"/> ST</td> <td>silber + transparent silver+transparent</td> <td><input type="checkbox"/> SS</td> <td>silber + silber silver+silver</td> </tr> <tr> <td><input type="checkbox"/> IW</td> <td>beige-glänzend ivory white</td> <td><input checked="" type="checkbox"/> IT</td> <td>beige + transparent ivory+transparent</td> <td><input type="checkbox"/> II</td> <td>beige + beige ivory+ivory</td> </tr> <tr> <td><input checked="" type="checkbox"/> RD</td> <td>rot red</td> <td><input checked="" type="checkbox"/> RT</td> <td>rot + transparent red+transparent</td> <td><input checked="" type="checkbox"/> RR</td> <td>rot + rot red+red</td> </tr> <tr> <td><input checked="" type="checkbox"/> GR</td> <td>grün green</td> <td><input checked="" type="checkbox"/> GT</td> <td>grün + transparent green+transparent</td> <td><input checked="" type="checkbox"/> GG</td> <td>grün + grün green+green</td> </tr> <tr> <td><input checked="" type="checkbox"/> OR</td> <td>orange orange</td> <td><input checked="" type="checkbox"/> OT</td> <td>orange + transparent orange+transparent</td> <td><input checked="" type="checkbox"/> OO</td> <td>orange + orange orange+orange</td> </tr> </table>	<input checked="" type="checkbox"/> AT	anthrazit anthracite	<input checked="" type="checkbox"/> AT	anthrazit+transparent anthracite+transparent	<input checked="" type="checkbox"/> AA	anthrazit+anthrazit anthracite+anthracite	<input type="checkbox"/> ES	silber-matt elox silver	<input checked="" type="checkbox"/> ST	silber + transparent silver+transparent	<input type="checkbox"/> SS	silber + silber silver+silver	<input type="checkbox"/> IW	beige-glänzend ivory white	<input checked="" type="checkbox"/> IT	beige + transparent ivory+transparent	<input type="checkbox"/> II	beige + beige ivory+ivory	<input checked="" type="checkbox"/> RD	rot red	<input checked="" type="checkbox"/> RT	rot + transparent red+transparent	<input checked="" type="checkbox"/> RR	rot + rot red+red	<input checked="" type="checkbox"/> GR	grün green	<input checked="" type="checkbox"/> GT	grün + transparent green+transparent	<input checked="" type="checkbox"/> GG	grün + grün green+green	<input checked="" type="checkbox"/> OR	orange orange	<input checked="" type="checkbox"/> OT	orange + transparent orange+transparent	<input checked="" type="checkbox"/> OO	orange + orange orange+orange
<input checked="" type="checkbox"/> AT	anthrazit anthracite	<input checked="" type="checkbox"/> AT	anthrazit+transparent anthracite+transparent	<input checked="" type="checkbox"/> AA	anthrazit+anthrazit anthracite+anthracite																																			
<input type="checkbox"/> ES	silber-matt elox silver	<input checked="" type="checkbox"/> ST	silber + transparent silver+transparent	<input type="checkbox"/> SS	silber + silber silver+silver																																			
<input type="checkbox"/> IW	beige-glänzend ivory white	<input checked="" type="checkbox"/> IT	beige + transparent ivory+transparent	<input type="checkbox"/> II	beige + beige ivory+ivory																																			
<input checked="" type="checkbox"/> RD	rot red	<input checked="" type="checkbox"/> RT	rot + transparent red+transparent	<input checked="" type="checkbox"/> RR	rot + rot red+red																																			
<input checked="" type="checkbox"/> GR	grün green	<input checked="" type="checkbox"/> GT	grün + transparent green+transparent	<input checked="" type="checkbox"/> GG	grün + grün green+green																																			
<input checked="" type="checkbox"/> OR	orange orange	<input checked="" type="checkbox"/> OT	orange + transparent orange+transparent	<input checked="" type="checkbox"/> OO	orange + orange orange+orange																																			

STECKDOSE SCHUKO+KS 2P+E 16A 250V~ 2M

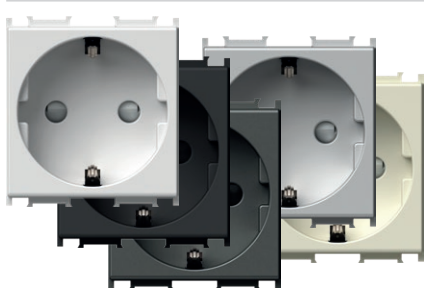

- VM10PW
- VM10SB
- VM10AT
- VM10ES
- VM10IW

- Steckdose mit Schutzkontakt
- 16A 250V~, Typ VM10
- entspricht IEC 60884-1, CEE7
- Schraubklemmen 1,5-2,5 mm²
- Steckdose mit erhöhtem Berührungsschutz

SOCKET SCHUKO+KS 2P+E 16A 250V~ 2M

- 2P+E schuko
- 16A 250V~, type VM10
- in accordance with IEC 60884-1, CEE7
- screw contacts 1.5-2.5 mm²
- shuttered live contacts



STECKDOSE SCHUKO+KS 2P+E 16A 250V~ 2M

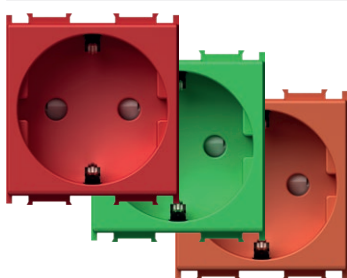

- VM10RD
- VM10GR
- VM10OR

- Steckdose mit Schutzkontakt
- 16A 250V~, Typ VM10
- entspricht IEC 60884-1, CEE7
- Schraubklemmen 1,5-2,5 mm²
- Steckdose mit erhöhtem Berührungsschutz

SOCKET SCHUKO+KS 2P+E 16A 250V~ 2M

- 2P+E schuko
- 16A 250V~, type VM10
- in accordance with IEC 60884-1, CEE7
- screw contacts 1.5-2.5 mm²
- shuttered live contacts



STECKDOSE SCHUKO+KS+KLAPPDECKEL 2P+E 16A 250V~ 2M

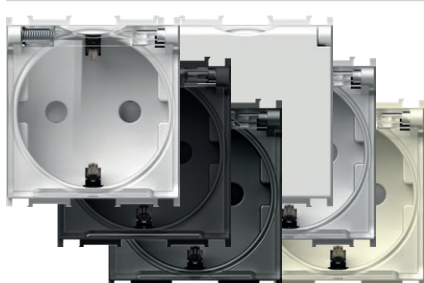

- VM11PT
- VM11BT
- VM11AT
- VM11ST
- VM11IT
- VM11PP

- Steckdose mit Schutzkontakt mit Klappdeckel
- 16A 250V~, Typ VM11
- entspricht IEC 60884-1, CEE7
- Schraubklemmen 1,5-2,5 mm²
- Steckdose mit erhöhtem Berührungsschutz

SOCKET SCHUKO+KS+COVER

- 2P+E 16A 250V~ 2M
- 2P+E schuko+cover
- 16A 250V~, type VM11
- in accordance with IEC 60884-1, CEE7
- screw contacts 1.5-2.5 mm²
- shuttered live contacts



STECKDOSE EURO+KS 2P 10A 250V~ 1M

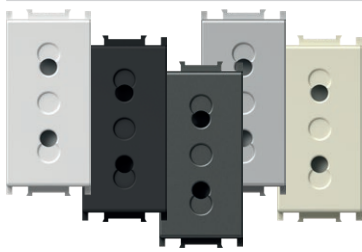

- VM20PW
- VM20SB
- VM20AT
- VM20ES
- VM20IW

- 2P Eurosteckdose
- 10A 250V~, Typ VM20
- entspricht IEC 60884-1, CEE7
- Schraubklemmen 1,5–2,5 mm²
- Steckdose mit erhöhtem Berührungsschutz



SOCKET EURO+KS 2P 10A 250V~ 1M

- 2P Euro
- 10A 250V~, type VM20
- in accordance with IEC 60884-1, CEE7
- screw contacts 1.5-2.5 mm²
- shuttered live contacts

STECKDOSE FRANZÖSISCH+KS 2P+E 16A 250V~ 2M



- VM40PW
- VM40SB
- VM40AT
- VM40ES
- VM40IW

- Steckdose mit Schutzkontakt, französischer Standard
- 16A 250V~, Typ VM40
- entspricht IEC 60884-1, NF C 61-314, CEE7
- Schraubklemmen 1,5–2,5 mm²
- Steckdose mit erhöhtem Berührungsschutz



SOCKET FRENCH+KS 2P+E 16A 250V~ 2M

- 2P+E French
- 16A 250V~, type VM40
- in accordance with IEC 60884-1, NF C 61-314, CEE7
- screw contacts 1.5-2.5 mm²
- shuttered live contacts

STECKDOSE FRANZÖSISCH+KS 2P+E 16A 250V~ 2M

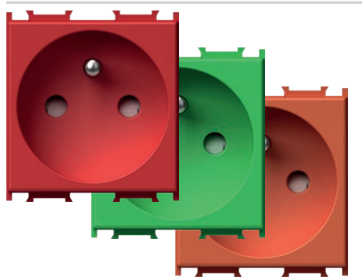

-  VM40RD
-  VM40GR
-  VM40OR

- Steckdose mit Schutzkontakt, französischer Standard
- 16A 250V~, Typ VM40
- entspricht IEC 60884-1, NF C 61-314, CEE7
- Schraubklemmen 1,5–2,5 mm²
- Steckdose mit erhöhtem Berührungsschutz

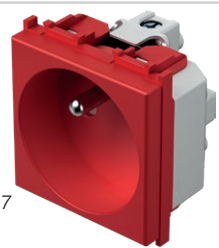

SOCKET FRENCH+KS 2P+E 16A 250V~ 2M

- 2P+E French
- 16A 250V~, type VM40
- in accordance with IEC 60884-1, NF C 61-314, CEE7
- screw contacts 1.5-2.5 mm²
- shuttered live contacts

STECKDOSE FRANZÖSISCH+KS+KLAPPDECKEL 2P+E 16A 250V~ 2M



- VM41PT
- VM41BT
- VM41AT
- VM41PP
- VM41ST
- VM41IT

- Steckdose mit Schutzkontakt mit Klappdeckel, französischer Standard
- 16A 250V~, Typ VM41
- entspricht IEC 60884-1, NF C 61-314, CEE7
- Schraubklemmen 1,5–2,5 mm²
- Steckdose mit erhöhtem Berührungsschutz



SOCKET FRENCH+KS+COVER

- 2P+E 16A 250V~ 2M
- 2P+E French+cover
- 16A 250V~, type VM41
- in accordance with IEC 60884-1, NF C 61-314, CEE7
- screw contacts 1.5-2.5 mm²
- shuttered live contacts

STECKDOSE ITALIENISCH P17/11+KS 2P+E 16A 250V~ 1M

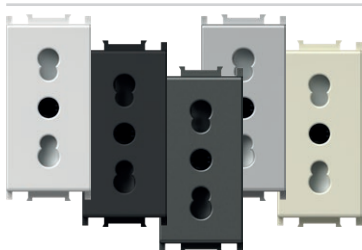

- VM30PW
- VM30SB
- VM30AT
- VM30ES
- VM30IW

- Steckdose mit Schutzkontakt, italienischer Standard P17/11
- 16A 250V~, Typ VM30
- entspricht IEC 60884-1, CEI 23-50
- Schraubklemmen 1,5–2,5 mm²
- Steckdose mit erhöhtem Berührungsschutz



SOCKET ITALIAN P17/11+KS 2P+E 16A 250V~ 1M

- 2P+E Italian P17/11
- 16A 250V~, type VM30
- in accordance with IEC 60884-1, CEI 23-50
- screw contacts 1.5-2.5 mm²
- shuttered live contacts

STECKDOSE SCHUKO/ITA P17/11+KS 2P+E 16A 250V~ 2M

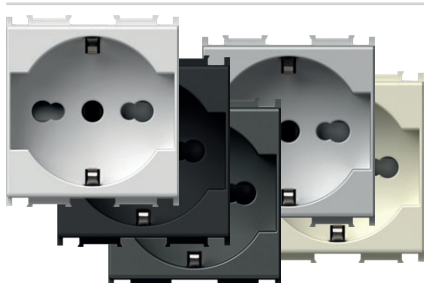

- VM31PW
- VM31SB
- VM31AT
- VM31ES
- VM31IW

- Steckdose mit Schutzkontakt, italienischer Standard P17/11
- 16A 250V~, Typ VM31
- entspricht IEC 60884-1, CEI 23-50
- Schraubklemmen 1,5–2,5 mm²
- Steckdose mit erhöhtem Berührungsschutz

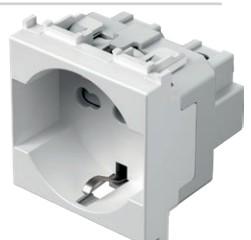

SOCKET SCHUKO/ITA P17/11+KS

- 2P+E 16A 250V~ 2M
- 2P+E schuko/Italian P17/11
- 16A 250V~, type VM31
- in accordance with IEC 60884-1, CEI 23-50
- screw contacts 1.5-2.5 mm²
- shuttered live contacts

STECKDOSE SCHUKO/ITA P30+KS 2P+E 16A 250V~ 2M

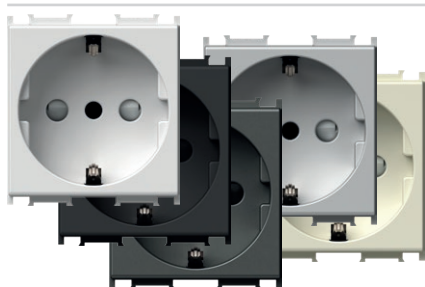

- VM32PW
- VM32SB
- VM32AT
- VM32ES
- VM32IW

- Steckdose mit Schutzkontakt, italienischer Standard P30
- 16A 250V~, Typ VM32
- entspricht IEC 60884-1, CEI 23-50
- Schraubklemmen 1,5–2,5 mm²
- Steckdose mit erhöhtem Berührungsschutz



SOCKET SCHUKO/ITA P30+KS
2P+E 16A 250V~ 2M

- 2P+E schuko/Italian P30
- 16A 250V~, type VM32
- in accordance with IEC 60884-1, CEI 23-50
- screw contacts 1.5-2.5 mm²
- shuttered live contacts

STECKDOSE ITALIENISCH P11+KS 2P+E 10A 250V~ 1M

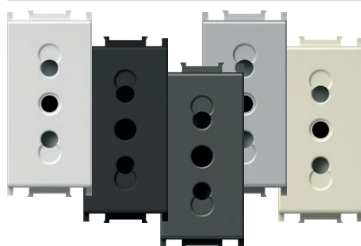

- VM33PW
- VM33SB
- VM33AT
- VM33ES
- VM33IW

- Steckdose mit Schutzkontakt, italienischer Standard P11
- 10A 250V~, Typ VM33
- entspricht IEC 60884-1, CEI 23-50
- Schraubklemmen 1,5–2,5 mm²
- Steckdose mit erhöhtem Berührungsschutz



SOCKET ITALIAN P11+KS 2P+E 10A 250V~ 1M

- 2P+E Italian P11
- 10A 250V~, type VM33
- in accordance with IEC 60884-1, CEI 23-50
- screw contacts 1.5-2.5 mm²
- shuttered live contacts

STECKDOSE EURO/AMERIKANISCH+KS 2P 16A 250V~ 1M

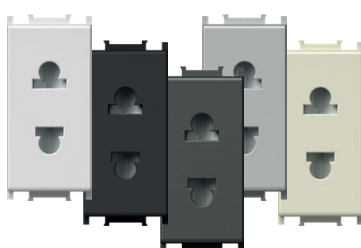

- VM21PW
- VM21SB
- VM21AT
- VM21ES
- VM21IW

- 2P Euro/amerikanischer Standard
- 16A 250V~, Typ VM21
- Schraubklemmen 1,5–2,5 mm²
- Steckdose mit erhöhtem Berührungsschutz
- nur für Länder außer EU



SOCKET EURO/AMERICAN+KS 2P 16A 250V~ 1M

- 2P Euro/American
- 16A 250V~, type VM21
- screw contacts 1.5-2.5 mm²
- shuttered live contacts
- only for countries not members of EU

STECKDOSE BRITISCH BS 1363-2+KS 2P+E 13A 250V~ 2M

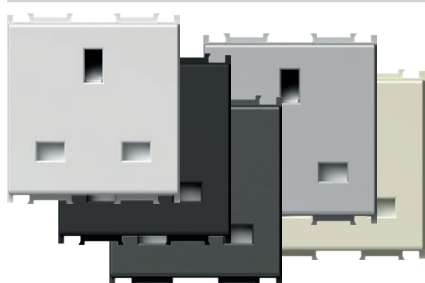

- VM52PW
- VM52SB
- VM52AT
- VM52ES
- VM52IW

- Steckdose mit Schutzkontakt, britischer Standard BS 1363-2
- 13A 250V~, Typ VM52
- entspricht BS 1363-2
- Schraubklemmen 1,5-4 mm²
- Schutz gegen Berührung stromführender Teile



SOCKET BRITISH BS 1363-2+KS 2P+E 13A 250V~ 2M

- 2P+E British BS 1363-2
- 13A 250V~, type VM52
- in accordance with BS 1363-2
- screw contacts 1.5-4 mm²
- shuttered live contacts

STECKDOSE MULTISTANDARD+KS 2P+E 13A 250V~ 2M

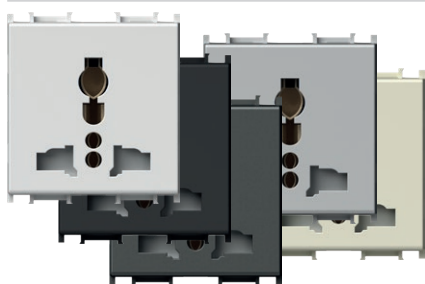

- VM55PW
- VM55SB
- VM55AT
- VM55ES
- VM55IW

- Steckklemmen 1,5-2,5mm²
- Schutz gegen Berührung stromführender Teile

SOCKET MULTI-STANDARD+KS 2P+E 13A 250V~ 2M

- plug-in contacts 1.5–2.5 mm²
- built-in contact protection



ÜBERSpannungSSchutz MPE MINI 275V/50Hz



VM80

- Parallelanschluss zur ersten Steckdose in Reihe
- Schutzklasse III
- U_c=275Vac, U_{oc}/I_{sc}=6kV/3kA, U_p<800V
- entspricht IEC 61643-1
- Leiter 1,5 mm², IP20
- Signalton bei Zerstörung



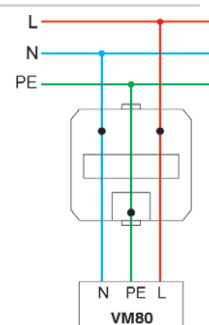

SURGE PROTECTOR MPE MINI 275V/50Hz

- parallel connection with the first socket in the row
- protection class III
- U_c=275Vac, U_{oc}/I_{sc}=6kV/3kA, U_p<800V
- in accordance with IEC 61643-1
- wires 1.5mm², IP20
- sound signal at breakdown

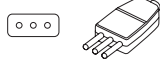

S O C K E T S V M

STECKDOSEN- UND STECKER-ÜBEREINSTIMMUNG
 SOCKETS AND PLUGS MATCHING

STECKDOSE / SOCKET	VM10 VM11	VM20	VM30	VM33	VM31	VM32	VM40 VM41	VM21	VM55
STECKERTYP / PLUG STYLE deutsch / German 	•				•	•			•
französisch / French 	•				•	•	•		•
italienisch / Italian S11 			•	•	•	•			•
italienisch / Italian S17 			•		•				•
euro 	•	•	•		•	•	•	•	•

STECKDOSEN- UND STECKER-ÜBEREINSTIMMUNG
 SOCKETS AND PLUGS MATCHING

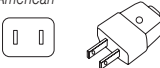
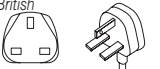
STECKDOSE / SOCKET	VM21	VM52	VM55
STECKERTYP / PLUG STYLE amerikanisch / American 	•		•
britisch / British BS 1363-2 		•	•

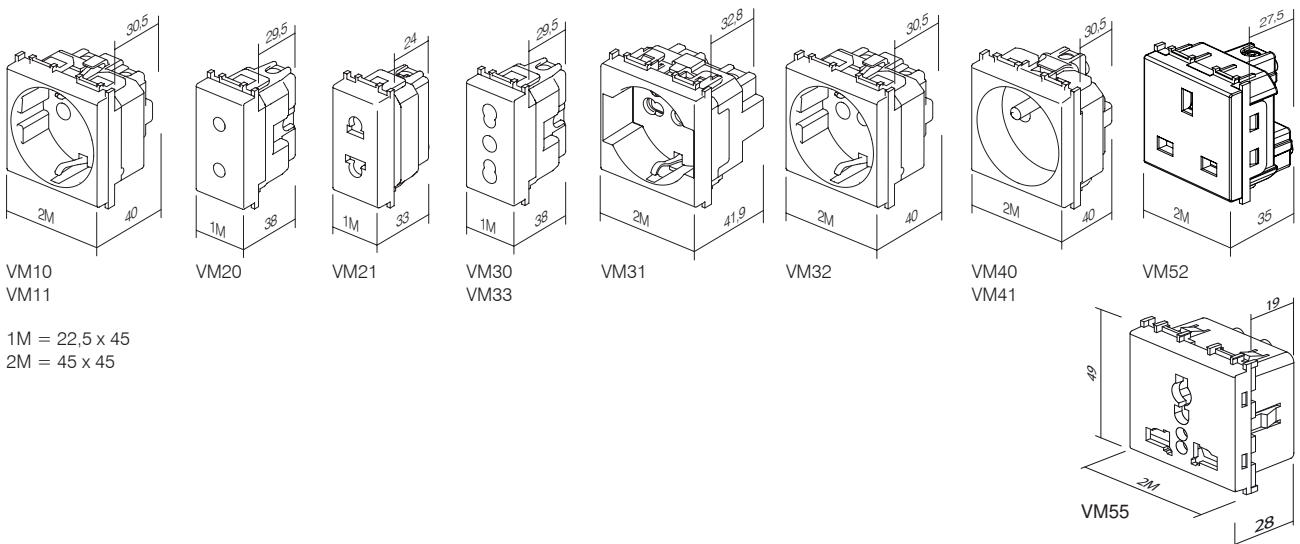



Typ type	Bezeichnung description	Technische Daten technical data	Größe size	Farbe colour
KM10	STECKDOSE TV – EINZELDOSE SOCKET TV BASIC	0dB	1M	<input type="checkbox"/> PW weiß-glänzend polar white
KM11	STECKDOSE TV – ENDDOSE SOCKET TV END-LINE	1dB	<input checked="" type="checkbox"/> SB schwarz-matt soft touch black	
KM12	STECKDOSE TV – DURCHGANGSDOSE SOCKET TV TROUGHPASS	10dB	1M	<input checked="" type="checkbox"/> AT anthrazit anthracite
·	·	·	·	<input type="checkbox"/> ES silber-matt elox silver
·	·	·	·	<input type="checkbox"/> IW beige-glänzend ivory white

TV-EINZELDOSE 0dB 1M

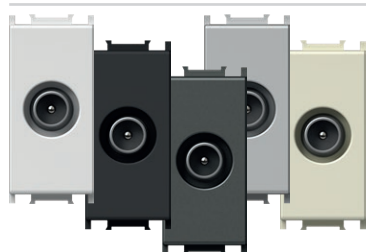

- KM10PW
- KM10SB
- KM10AT
- KM10ES
- KM10IW

- TV-Einzeldose
- Dämpfung 0 dB
- Rückanschluss – F-Standard
SOCKET TV BASIC 0dB 1M
- TV basic
- reduction 0dB
- back connector – F standard



TV-EINZELDOSE 0dB 2M

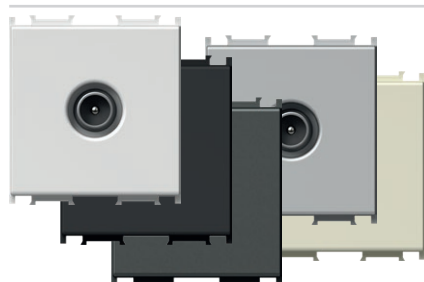

- KM20PW
- KM20SB
- KM20AT
- KM20ES
- KM20IW

- TV-Einzeldose
- Dämpfung 0 dB
- Rückanschluss – F-Standard
SOCKET TV BASIC 0dB 2M
- TV basic
- reduction 0dB
- back connector – F standard



TV-ENDDOSE 1dB 1M



- KM11PW
- KM11SB
- KM11AT
- KM11ES
- KM11IW

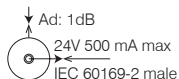

- TV-Enddose
- Übertragungsbandsbreite 5÷2400 MHz
- Dämpfung < 1 dB
- entspricht EN 50083-1
- Schraubklemmen
SOCKET TV END-LINE 1dB 1M
- TV end-line
- frequency range 5÷2400 MHz
- reduction < 1 dB
- in accordance with EN 50083-1
- screw contacts



TV-DURCHGANGSDOSE 10dB 1M



- KM12PW
- KM12SB
- KM12AT
- KM12ES
- KM12IW

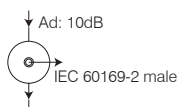

- TV-Durchgangsdose
- Übertragungsbandsbreite 5÷2400 MHz
- Dämpfung < 10 dB
- entspricht EN 50083-1
- Schraubklemmen
SOCKET TV TROUGHPASS 10dB 1M
- TV troughpass
- frequency range 5÷2400 MHz
- reduction < 10 dB
- in accordance with EN 50083-1
- screw contacts



SAT-EINZELDOSE 0dB 1M



- KM15PW
- KM15SB
- KM15AT
- KM15ES
- KM15IW

- SAT-Einzeldose
- Dämpfung 0 dB
- Rückanschluss – F-Standard
- SOCKET SAT BASIC 0dB 1M*
- SAT basic
- reduction 0dB
- back connector – F standard



SAT-EINZELDOSE 0dB 2M

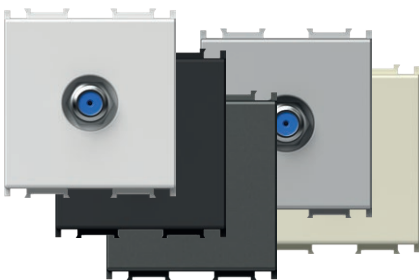

- KM24PW
- KM24SB
- KM24AT
- KM24ES
- KM24IW

- SAT-Einzeldose
- Dämpfung 0 dB
- Rückanschluss – F-Standard
- SOCKET SAT BASIC 0dB 2M*
- SAT basic
- reduction 0dB
- back connector – F standard



SAT-ENDDOSE 1dB 1M

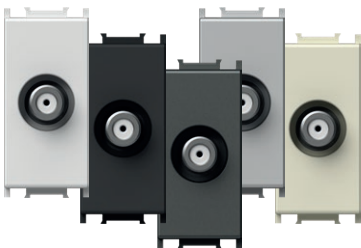

- KM16PW
- KM16SB
- KM16AT
- KM16ES
- KM16IW

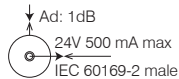

- SAT-Enddose
- Übertragungsbandbreite 5÷2400 MHz
- Dämpfung < 1dB
- entspricht EN 50083-1
- Schraubklemmen
- SOCKET SAT END-LINE 1dB 1M*
- SAT end-line
- frequency range 5÷2400 MHz
- reduction < 1dB
- in accordance with EN 50083-1
- screw contacts



R-EINZELDOSE 0dB 1M



- KM19PW
- KM19SB
- KM19AT
- KM19ES
- KM19IW

- R-Einzeldose
- Dämpfung 0 dB
- Rückanschluss – F-Standard
- SOCKET R BASIC 0dB 1M*
- R basic
- reduction 0dB
- back connector – F standard



R-EINZELDOSE 0dB 2M

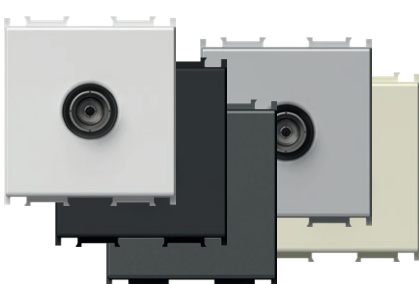

- KM29PW
- KM29SB
- KM29AT
- KM29ES
- KM29IW

- R-Einzeldose
- Dämpfung 0 dB
- Rückanschluss – F-Standard
- SOCKET R BASIC 0dB 2M*
- R basic
- reduction 0dB
- back connector – F standard



SAT-TV-ENDDOSE 1dB 2M

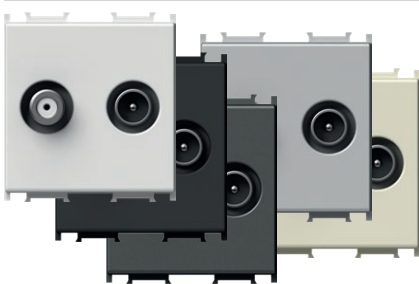

- KM25PW
- KM25SB
- KM25AT
- KM25ES
- KM25IW

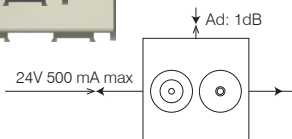

- SAT-TV-Enddose
- Übertragungsbandbreite 5÷2400 MHz
- Dämpfung < 1dB
- entspricht EN 50083-1
- Schraubklemmen
- SOCKET SAT-TV END-LINE 1dB 2M*
- SAT-TV end-line
- frequency range 5÷2400 MHz
- reduction < 1dB
- in accordance with EN 50083-1
- screw contacts



GRUNDSCHALTUNGEN

BASIC CONNECTION SAMPLES

Einzelanschaltung
stand alone connection

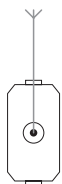

KM10
KM20
KM11
KM15
KM24
KM16
KM19
KM29
KM25

Sternanschaltung
star connection

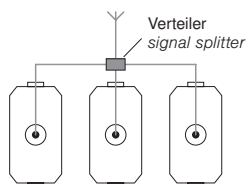

KM10
KM20
KM11
KM15
KM24
KM16
KM19
KM29
KM25

Durchgangsschaltung
throughpass connection

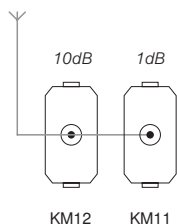

STECKDOSE AUDIO 2xRCA 1M



- KM22PW
- KM22SB
- KM22AT
- KM22ES
- KM22IW

- Audio-Anschlussdose – 2x RCA
- gelöteter Kabelanschluss hinten

SOCKET AUDIO 2xRCA 1M

- audio 2x RCA
- soldering connection of cable at the back side



STECKDOSE AUDIO-LAUTSPRECHER 1M



- KM23PW
- KM23SB
- KM23AT
- KM23ES
- KM23IW

- Audio-Anschlussdose – 2x Ø4 mm
- Kabelanschluss für Lautsprecher, Stecker Ø4 mm oder Gabel-Kabelstecker
- gelöteter Kabelanschluss hinten

SOCKET AUDIO LOUDSPEAKERS 1M

- audio 2x Ø4mm
- to accommodate speaker wire, banana plug Ø4mm or spades
- soldering connection of cable at the back side



STECKDOSE AUDIO-LAUTSPRECHER 2M



- KM26PW
- KM26SB
- KM26AT
- KM26ES
- KM26IW

- Audio-Anschlussdose – 2x Ø4 mm
- Kabelanschluss für Lautsprecher, Stecker Ø4 mm oder Gabel-Kabelstecker
- gelöteter Kabelanschluss hinten

SOCKET AUDIO LOUDSPEAKERS 2M

- audio 2x Ø4mm
- to accommodate speaker wire, banana plug Ø4mm or spades
- soldering connection of cable at the back side



1M = 22,5 x 45
2M = 45 x 45

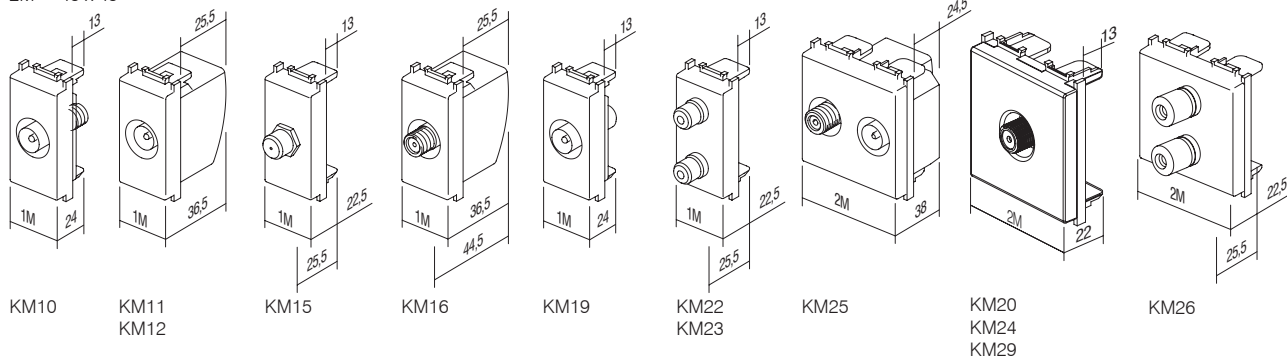

KM10

KM11
KM12

KM15

KM16

KM19

KM22
KM23

KM25

KM20
KM24
KM29

KM26

STECKDOSE TEL LT RJ11 6/4 1M



- KM30PW
- KM30SB
- KM30AT
- KM30ES
- KM30IW

- TEL LT mit Schraubklemmen
- RJ11 6/4
- entspricht IEC 60603-7
- Schraubklemmen

SOCKET TEL LT RJ11 6/4 1M

- TEL LT screw
- RJ11 6/4
- in accordance with IEC 60603-7
- screw contacts



STECKDOSE TEL BT SEC 6/6 1M

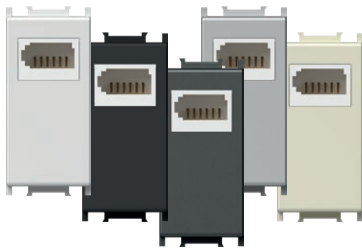

- KM31PW
- KM31SB
- KM31AT
- KM31ES
- KM31IW

- TEL BT britischer Standard
- SEC Sekundär 6/6
- entspricht BS 6312
- Schraubklemmen

SOCKET TEL BT SEC 6/6 1M

- TEL BT British standard
- SEC secondary 6/6
- in accordance with BS 6312
- screw contacts



STECKDOSE TEL KS RJ11 6/4 1M

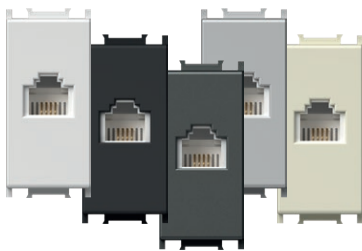

- KM36PW
- KM36SB
- KM36AT
- KM36ES
- KM36IW

- KS – keystone-Befestigungsstandard
- RJ11 6/4
- entspricht IEC 60603-7

SOCKET TEL KS RJ11 6/4 1M

- KS keystone fixing standard
- RJ11 6/4
- in accordance with IEC 60603-7

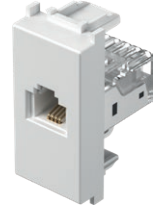

STECKDOSE CAT5e KS RJ45 8/8 1M

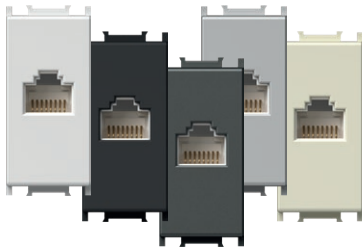

- KM37PW
- KM37SB
- KM37AT
- KM37ES
- KM37IW

- KS – keystone-Befestigungsstandard
- CAT5e, RJ45 8/8
- entspricht IEC 60603-7

SOCKET CAT5e KS RJ45 8/8 1M

- KS keystone fixing standard
- CAT5e, RJ45 8/8
- in accordance with IEC 60603-7

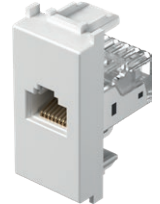

ADAPTER KS 1M

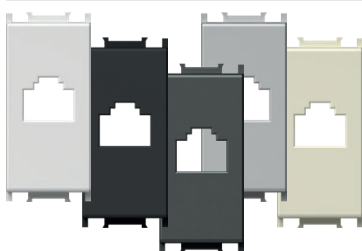

- KM35PW
- KM35SB
- KM35AT
- KM35ES
- KM35IW

- KS – keystone-Befestigungsstandard
- AMP, Avaya, Brandrex, FMT, Mfico, Tyco, ...
- ohne Kommunikationsmodul

ADAPTER KS 1M

- KS keystone fixing standard
- AMP, Avaya, Brandrex, FMT, Mfico, Tyco, ...
- communication module not included



ADAPTER KS MIT STAUBSCHUTZ 1M

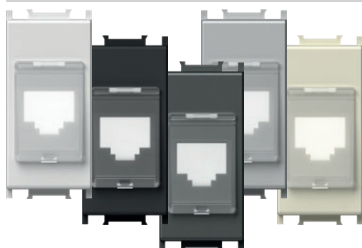

- KM38PW
- KM38SB
- KM38AT
- KM38ES
- KM38IW

- KS-keystone-Befestigungsstandard mit Staubschutz
- AMP, Avaya, Brandrex, FMT, Mfico, Tyco, ...
- ohne Kommunikationsmodul

ADAPTER KS WITH DUST PROTECTION 1M

- KS keystone fixing standard with dust protection
- AMP, Avaya, Brandrex, FMT, Mfico, Tyco, ...
- communication module not included



STECKDOSE CAT6 RJ45 SCH KS 8/8 1M

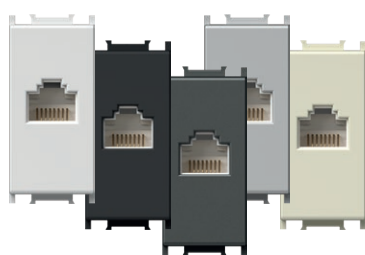

- KM39PW
- KM39SB
- KM39AT
- KM39ES
- KM39IW

- KS Keystone Befestigung Standard
 - Cat6 UTP werkzeuglos, RJ45 8/8
 - entspricht ISO / IEC 11801

SOCKET CAT6 SCH KS RJ45 8/8 1M

- KS keystone fixing standard
 - CAT6 UTP toolless, RJ45 8/8
 - in accordance with ISO/IEC 11801



ADAPTER KS UNIVERSAL 1M

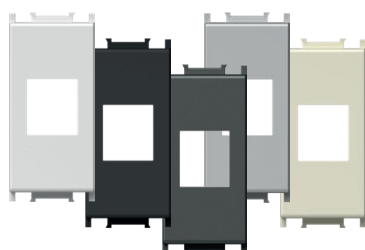

- KM50PW
- KM50SB
- KM50AT
- KM50ES
- KM50IW

- KS – keystone-Befestigungsstandard
 - geeignet für HDMI, USB
 - ohne Kommunikationsmodul

ADAPTER KS UNIVERSAL 1M

- KS keystone fixing standard
 - suitable for HDMI, USB
 - communication module not included



ADAPTER PD 1M

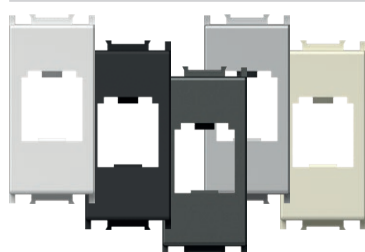

- KM40PW
- KM40SB
- KM40AT
- KM40ES
- KM40IW

- PD Panduit Mini-COM-Befestigungsstandard
 - ohne Kommunikationsmodul

ADAPTER PD 1M

- PD Panduit Mini-COM fixing standard
 - communication module not included



ADAPTER PD MIT STAUBSCHUTZ 1M



- KM43PW
- KM43SB
- KM43AT
- KM43ES
- KM43IW

- PD – Panduit Mini-COM-Befestigungsstandard
 mit Staubschutz
 - ohne Kommunikationsmodul

ADAPTER PD WITH DUST PROTECTION 1M

- PD Panduit Mini-COM fixing standard with
 dust protection
 - communication module not included



ADAPTER R&M 1M

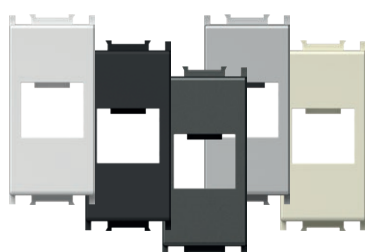

- KM46PW
- KM46SB
- KM46AT
- KM46ES
- KM46IW

- R&M-Befestigungsstandard
 - ohne Kommunikationsmodul

ADAPTER R&M 1M

- R&M fixing standard
 - communication module not included

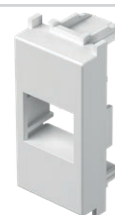

ADAPTER R&M CAT6A 1M

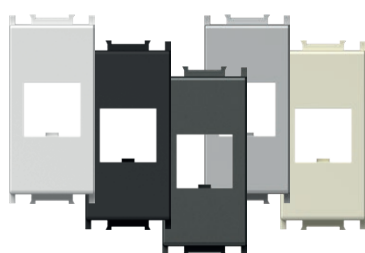

- KM52PW
- KM52SB
- KM52AT
- KM52ES
- KM52IW

- R&M Befestigung für CAT6A
 - ohne Kommunikationsmodul

ADAPTER R&M CAT6A 1M

- R&M fixing for CAT6A
 - communication module not included





- KM47PW
- KM47SB
- KM47AT
- KM47ES
- KM47IW

ADAPTER R&M MIT STAUBSCHUTZ 1M

- R&M-Befestigungsstandard mit Staubschutz
- ohne Kommunikationsmodul

ADAPTER R&M WITH DUST PROTECTION 1M

- R&M fixing standard with dust protection
- communication module not included



- KM53PW
- KM53SB
- KM53AT
- KM53ES
- KM53IW

ADAPTER R&M CAT6A MIT STAUBSCHUTZ 1M

- R&M Befestigung für CAT6A mit Staubschutzdeckel
- ohne Kommunikationsmodul

ADAPTER R&M CAT6A WITH DUST PROTECTION 1M

- R&M fixing for CAT6A with dust protection
- communication module not included



ADAPTER LK 1M

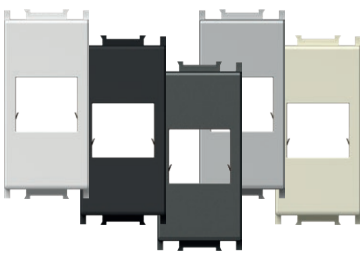

- KM45PW
- KM45SB
- KM45AT
- KM45ES
- KM45IW

- LK LeoniKerpen eLine-/BKS NewLine-Befestigungsstandard
- ohne Kommunikationsmodul

ADAPTER LK 1M

- LK LeoniKerpen eLine / BKS NewLine fixing standard
- communication module not included



ADAPTER NEXANS/SCHRACK 2M

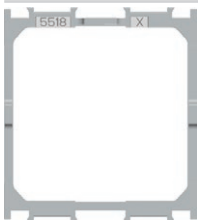

KA26

- Adapter zur Befestigung der Module Nexans LANmark und Schrack in Größe 45 x 45 mm
- geeignet für Nexans Typ N423.540N
- geeignet für Schrack Typ HSEMD02W2F
- ohne Kommunikationsmodul

ADAPTER NEXANS/SCHRACK 2M

- fixing adapter for Nexans LANmark and Schrack module 45x45mm
- suitable for Nexans type N423.540N
- suitable for Schrack type HSEMD02W2F
- communication module not included

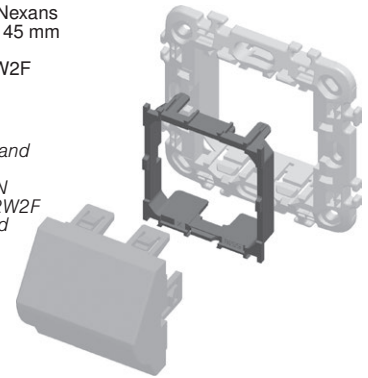

ADAPTER AT&T SYSTIMAX MIT STAUBSCHUTZ 1M



- KM48PW
- KM48SB
- KM48AT
- KM48ES
- KM48IW

- AT&T Systemax-Befestigungsstandard mit Staubschutz
- ohne Kommunikationsmodul

ADAPTER AT&T SYSTIMAX WITH DUST PROTECTION 1M

- AT&T Systemax fixing standard with dust protection
- communication module not included



STECKDOSE USB TYP A 1M



- KM51PW
- KM51SB
- KM51AT
- KM51ES
- KM51IW

- USB 2.0 Steckdose Typ A
- Schraubklemmen, Raster 5 mm, 1,5 mm², 1x2P + 1x3P
- Verdrahtung:
PIN 1 – VCC (+5V, roter Leiter)
PIN 2 – Signal – (weißer Leiter)
PIN 3 – Signal – (grüner Leiter)
PIN 4 – GND – Masse (schwarzer Leiter)
S – Schirm
- entspricht Richtlinie 2011/95/EU (RoHS2)

SOCKET USB TYPE A 1M

- USB 2.0 socket type A
- screw contacts, raster 5 mm, 1,5 mm², 1x2P + 1x3P
- wiring:
PIN 1 – VCC (+5V, red wire)
PIN 2 – Data – (white wire)
PIN 3 – Data + (green wire)
PIN 4 – GND – ground (black wire)
S – shield
- in accordance with directive 2011/95/EU (RoHS2)



1M = 22,5 x 45
2M = 45 x 45

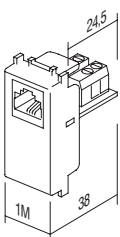

KM30

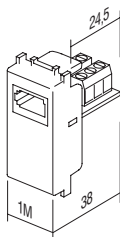

KM31

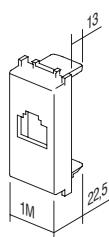

KM35
KM38
KM48

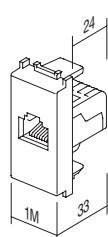

KM36
KM37
KM39

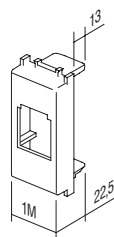

KM40
KM43

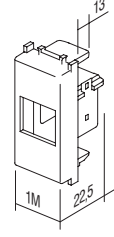

KM45

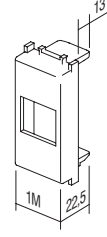

KM46
KM47
KM50
KM52
KM53

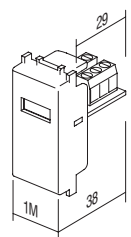

KM51

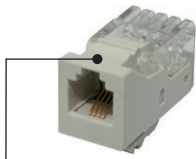

KA10

Typ <i>type</i>	Bezeichnung <i>description</i>	Technische Daten <i>technical data</i>
KA10	KONNEKTOR KS CAT3 <i>CONNECTOR KS CAT3</i>	RJ11 6/4
KA11	KONNEKTOR KS CAT5e <i>CONNECTOR KS CAT5e</i>	RJ45 8/8
KA12	KONNEKTOR KS CAT5eS <i>CONNECTOR KS CAT5eS</i>	RJ45 8/8
⋮	⋮	⋮
	KA10	<p>KONNEKTOR KS CAT3 RJ11 6/4</p> <ul style="list-style-type: none"> - KS – keystone-Befestigungsstandard - CAT3, RJ11 6/4 - entspricht IEC 60603-7 <p><i>CONNECTOR KS CAT3 RJ11 6/4</i></p> <ul style="list-style-type: none"> - KS keystone fixing standard - CAT3, RJ11 6/4 - in accordance with IEC 60603-7
	KA11	<p>KONNEKTOR KS CAT5e RJ45 8/8</p> <ul style="list-style-type: none"> - KS – keystone-Befestigungsstandard - CAT5e, RJ45 8/8 - entspricht IEC 60603-7 <p><i>CONNECTOR KS CAT5e RJ45 8/8</i></p> <ul style="list-style-type: none"> - KS keystone fixing standard - CAT5e, RJ45 8/8 - in accordance with IEC 60603-7
	KA12	<p>KONNEKTOR KS CAT5eS RJ45 8/8</p> <ul style="list-style-type: none"> - KS – keystone-Befestigungsstandard - CAT5eS, RJ45 8/8 - entspricht IEC 60603-7 <p><i>CONNECTOR KS CAT5eS RJ45 8/8</i></p> <ul style="list-style-type: none"> - KS keystone fixing standard - CAT5eS, RJ45 8/8 - in accordance with IEC 60603-7
	KA15	<p>KONNEKTOR KS CAT6 SCH RJ45 8/8</p> <ul style="list-style-type: none"> - KS – keystone-Befestigungsstandard - CAT6 UTP toolless, RJ45 8/8 - entspricht ISO/IEC 11801 <p><i>CONNECTOR KS CAT6 SCH RJ45 8/8</i></p> <ul style="list-style-type: none"> - KS keystone fixing standard - CAT6 UTP toolless, RJ45 8/8 - in accordance with ISO/IEC 11801
	KA16	<p>KONNEKTOR KS CAT6S SCH RJ45 8/8</p> <ul style="list-style-type: none"> - KS – keystone-Befestigungsstandard - CAT6S STP toolless, RJ45 8/8 - entspricht ISO/IEC 11801 <p><i>CONNECTOR KS CAT6S SCH RJ45 8/8</i></p> <ul style="list-style-type: none"> - KS keystone fixing standard - CAT6S STP toolless, RJ45 8/8 - in accordance with ISO/IEC 11801
	KA17	<p>KONNEKTOR KS CAT6a SCH RJ45 8/8</p> <ul style="list-style-type: none"> - KS – keystone-Befestigungsstandard - CAT6a STP toolless, RJ45 8/8 - entspricht ISO/IEC 11801 <p><i>CONNECTOR KS CAT6a SCH RJ45 8/8</i></p> <ul style="list-style-type: none"> - KS keystone fixing standard - CAT6a STP toolless, RJ45 8/8 - in accordance with ISO/IEC 11801



KA18

KONNEKTOR SLIM KS CAT6S SCH RJ45 8/8

- KS – Keystone-Befestigungsstandard
- Slim-Ausführung
- CAT6S STP toolless, RJ45 8/8
- entspricht ISO/IEC 11801
- auch für die Verwendung als Doppeladapter KE46 geeignet

CONNECTOR SLIM KS CAT6S SCH RJ45 8/8

- KS keystone fixing standard
- slim style
- CAT6S STP toolless, RJ45 8/8
- in accordance with ISO/IEC 11801
- suitable also for KE46 double adapter



KA27

KONNEKTOR KS HDMI

- KS – keystone-Befestigungsstandard
- nur in Kombination mit Adapter KM50
- HDMI/HDMI

CONNECTOR KS HDMI

- KS keystone fixing standard
- only in combination with adapter KM50
- HDMI/HDMI



KA28

KABEL KS HDMI

- KS – keystone-Befestigungsstandard
- nur in Kombination mit Adapter KM50
- HDMI/HDMI

CABLE KS HDMI

- KS keystone fixing standard
- only in combination with adapter KM50
- HDMI/HDMI



EM31



PW



Typ type	Bezeichnung description	Technische Daten technical data	Größe size	Farbe colour
EM12	DIMMER DREH-WECHSEL DIMMER ROTATIVE 2WAY	RL 300W	1M	<input type="checkbox"/> PW weiß-glänzend polar white
EM23	EINBAUDIMMER DIMMER INBOX	R (250 W), (RC,RL 200VA)	/	<input checked="" type="checkbox"/> SB schwarz-matt soft touch black
.	.	.	.	<input type="checkbox"/> AT anthrazit anthracite
.	.	.	.	<input type="checkbox"/> ES silber-matt elox silver
.	.	.	.	<input type="checkbox"/> IW beige-glänzend ivory white

 BL blau
blue

 RD rot
red

 GR grün
green

 OR orange
orange

 RG rot/grün
red/green

DIMMER DREH-WECHSEL RL 300 W 1M



- EM12PW
- EM12SB
- EM12AT
- EM12ES
- EM12IW

- Dreh-Wechsel
- Belastung RL, 40W – 300W
- Versorgung 230 V~ 50 Hz
- kann mit Wechselschalter verbunden werden
- die Montage von mehreren Geräten in eine Dose kann nur unter der Voraussetzung erfolgen, dass deren maximale Gesamtleistung nicht die maximale Leistung eines Dimmers überschreitet
- in einem Stromkreis kann nur ein Dimmer verwendet werden
- es ist keine Sicherung eingebaut – verwenden Sie eine externe Sicherung
- entspricht EN 60669-1
- Schraubklemmen 1,5–2,5 mm²
- integrierte LED-Kontrollbeleuchtung für den Dimmungspegel



DIMMER ROTATIVE/2WAY RL 300W 1M

- rotation control with 2-way switch
- load RL, 40W - 300W
- supply voltage 230V~ 50Hz
- 2-way switch combination is possible
- installing several devices together in one box is only permitted if their total maximum load does not exceed the maximum power of a single dimmer
- one circuit allows the use of only one dimmer
- no built-in fuse – external fuse must be used
- in accordance with EN 60669-1
- screw contacts - 1.5-2.5mm²
- integrated LED indication of dimming level

DIMMER DREH-WECHSEL LED 60 W 1M



- EM13PW
- EM13SB
- EM13AT
- EM13ES
- EM13IW

- Dreh-Wechsel
- Belastung:
 - LED, 0–60 W (max. 6 dimmbare LED-Lampen)
 - GLS, 0–60 W
- Versorgung 230 V~ 50 Hz
- kann mit Wechselschalter verbunden werden
- die Montage von mehreren Geräten in eine Dose kann nur unter der Voraussetzung erfolgen, dass deren maximale Gesamtleistung nicht die maximale Leistung eines Dimmers überschreitet
- in einem Stromkreis kann nur ein Dimmer verwendet werden
- es ist keine Sicherung eingebaut – verwenden Sie eine externe Sicherung
- entspricht IEC60669-2-1
- Schraubklemmen 1,5–2,5 mm²



DIMMER ROTATIVE/2WAY LED 60W 1M

- rotation control with 2-way switch
- loads: LED, 0 – 60W (max. 6 dimmable LED lamps)
- GLS, 0 – 60W
- supply voltage 230V~ 50Hz
- 2-way switch combination is possible
- installing several devices together in one box is only permitted if their total maximum load does not exceed the maximum power of a single dimmer
- one circuit allows the use of only one dimmer
- no built-in fuse – external fuse must be used
- in accordance with IEC60669-2-1
- screw contacts - 1.5-2.5mm²

DIMMER DREH-WECHSEL LED 180 W



- EM14PW
- EM14SB
- EM14AT
- EM14ES
- EM14IW

- Dreh-Wechsel
- Belastung:
 - LED, 0–180 W (max. 20 dimmbare LED-Lampen)
 - GLS, 0–180 W
- Versorgung 230 V~ 50 Hz
- kann mit Wechselschalter verbunden werden
- die Montage von mehreren Geräten in eine Dose kann nur unter der Voraussetzung erfolgen, dass deren maximale Gesamtleistung nicht die maximale Leistung eines Dimmers überschreitet
- in einem Stromkreis kann nur ein Dimmer verwendet werden
- es ist keine Sicherung eingebaut – verwenden Sie eine externe Sicherung
- entspricht IEC60669-2-1
- Schraubklemmen 1,5–2,5 mm²



DIMMER ROTATIVE/2WAY LED 180W 1M

- rotation control with 2-way switch
- loads:
 - LED, 0 – 180W (max. 20 dimmable LED lamps)
 - GLS, 0 – 180W
- supply voltage 230V~ 50Hz
- 2-way switch combination is possible
- installing several devices together in one box is only permitted if their total maximum load does not exceed the maximum power of a single dimmer
- one circuit allows the use of only one dimmer
- no built-in fuse – external fuse must be used
- in accordance with IEC60669-2-1
- screw contacts - 1.5-2.5mm²

DIMMER DREH-AUS R 250W 1M



- EM15PW
- EM15SB
- EM15AT
- EM15ES
- EM15IW

- Dreh-Aus
- Belastung R, 40W - 250W
- Versorgung 230 V~ 50 Hz
- kann nicht mit Wechselschalter verbunden werden
- Verbindung von zwei Dimmern ist nicht gestattet
- entspricht EN 60669-1
- Schraubklemmen 1,5–2,5 mm²
- LED-Kontrollbeleuchtung



DIMMER ROTATIVE R 250W 1M

- rotation control without switch
- load R, 40W - 250W
- supply voltage 230V~ 50Hz
- 2-way switch combination is not possible
- more dimmers combination is not allowed
- in accordance with EN 60669-1
- screw contacts 1.5-2.5mm²
- LED indication

1-10 V DIMMER DREH-WECHSEL



- EM16PW
- EM16SB
- EM16AT
- EM16ES
- EM16IW

- Nennbetriebsspannung: 10 VDC
- min. Betriebsspannung: 0,7 VDC
- Dimmbereich:
 - 0,7 % - 100 % (je nach Netzteil und Belastung)
- min. Schwindstrom: 0,1 mA
- max. Schwindstrom: 120 mA
- max. Verbrauch: 0,35 W
- Überspannungsschutz:
 - 15,8 VDC bis 250 mA (nicht austauschbar)
- max. Pulsstrom: 3 ADC
- Art der Belastung: 0-10 V, 1-10 V und PWM
- Schaltertyp: mechanisch: schieben Ein/Aus
- Nullleiter: nicht erforderlich
- Nennbetriebsspannung: 100-240 VAC, 50-60 Hz
- max. Momentanstrom: 10 A
- max. Betriebsstrom: 8 A
- max. Belastung (bei 230 VAC): 1800 VA (1800 x pf = max. W)
- Isolationswiderstand: > 100 MΩ bei 250 VAC
- Überspannungs- und Kurzschlusschutz: 10 A, 350 VAC (nicht austauschbar)
- Drehwinkel: 270° ± 5°
- Betriebstemperatur: -5 bis 40 °C
- Lagertemperatur: -30 bis 80 °C
- max. Gehäusetemperatur: + 65 °C
- max. Luftfeuchtigkeit: 90 % (ohne Kondensation)
- EMC und Immunität: CISPR 15(2008), IEC 61547
- LVD: IEC 60669-1:2017, IEC 60669-2-1:2015



1-10 V DIMMER ROTARY TOGGLE

- nominal operating voltage: 10 VDC
- minimum operating voltage: 0.7 VDC
- dimming range: 0.7% – 100% (depending on power supply and loads)
- minimum sink current: 0.1 mA
- maximum sink current: 120 mA
- maximum consumption: 0.35 W
- surge protection: 15.8 VDC up to 250 mA (not replaceable)
- maximum pulse current: 3 ADC
- load types: 0-10 V, 1–10 V and PWM
- switch type: mechanical: push on/off
- zero cable: not required
- nominal operating voltage: 100–240 VAC, 50–60 Hz
- maximum instantaneous current: 10 A
- maximum operating current: 8 A
- maximum load (at 230 VAC): 1800 VA (1800 x pf = max. W)
- isolation resistance: > 100 MΩ at 250 VAC
- surge protection and Short-circuit protection: 10 A, 350 VAC (not replaceable)
- rotation angle: 270° ± 5°
- operating temperature: -5 to 40°C
- storing temperature: -30 to 80°C
- maximum housing temperature: 65°C
- maximum humidity: 90% (no condensation)
- EMC & immunity: CISPR 15(2008), IEC 61547
- LVD: IEC 60669-1:2017, IEC 60669-2-1:2015



EM23

EINBAUDIMMER R (250 W), (RC,RL 200VA)

- für den Einbau, in Verbindung mit Taster
- Belastung RLC 15-250W oder 15-200 VA
- Versorgung 230 V~ 50Hz
- kann mit mehreren Tastern verbunden werden
- Verbindung von mehreren Dimmern ist nicht gestattet
- Speicherfunktion integriert
- Soft-Ein/-Aus-Funktion
- »leading edge«
- Entspricht EN60669, EN60950, EN 61000, ETSI EN 300 220-1, ETSI EN 300 220-2
- Schraubklemmen für Durchmesser bis 2,5mm²

DIMMER INBOX R (250 W), (RC, RL 200 VA)

- *inbox, controlled by external push button*
- *load RLC 15-250W or 15-200 VA*
- *supply voltage 230V~ 50Hz*
- *several push-buttons combinations are possible*
- *more dimmers combination is not allowed*
- *light intensity memory*
- *soft start/stop function*
- *»leading edge«*
- *in accordance with EN60669, EN60950, EN 61000, ETSI EN 300 220-1, ETSI EN 300 220-2*
- *screw contacts to wires 2,5 mm²*



EM18

DIMMER EINBAU LED 250W

- für den Einbau, in Verbindung mit Taster
- Vorder- oder Hinterkante
- Versorgung 230 V~ 50 Hz
- kann mit mehreren Tastern verbunden werden
- Speicherfunktion für die letzte Einstellung, außer bei Ausfall der Versorgung
- Soft-Ein/Aus-Funktion
- Einstellung der minimalen Helligkeit
- Montage nur eines Gerätes in eine Dose
- nur für Gebrauch im Innenbereich
- entspricht EN 60669-1 und EN 60669-2-1

DIMMER INBOX LED 250W

- *inbox, controlled by external push button*
- *for leading or trailing edge*
- *supply voltage 230V~ 50Hz*
- *several push-buttons combinations is possible*
- *memory function of the last setting, except in the case of a power failure*
- *soft start / stop function*
- *minimum intensity control*
- *only one dimmer per wall box*
- *only for indoor usage*
- *in accordance with EN 60669-1 and EN 60669-2-1*



EM19

DIMMER EINBAU DC LED 96W

- für den Einbau, in Verbindung mit Taster
- Anschluss mit allen Konstantspannung-LED-Netzteilen und einigen Konstantstrom-LED-Netzteilen, 9- 48 V DC, maximal 96 W
- nicht für induktive Lasten geeignet
- kann mit mehreren Tastern und Dimmern verbunden werden
- Speicherfunktion für die letzte Einstellung, außer bei Ausfall der Versorgung
- Soft-Ein/Aus-Funktion
- Montage nur eines Gerätes in eine Dose
- nur für Gebrauch im Innenbereich

DIMMER INBOX DC LED 96W

- *inbox, controlled by external push button*
- *for use with constant voltage LED drivers and some constant current LED drivers, 9-48V DC, max 96W (also for LED strips)*
- *not for use with inductive loads*
- *several push-buttons combinations and several dimmers is possible*
- *memory function of the last setting, except in the case of a power failure*
- *soft start / stop function*
- *only one dimmer per wall box*
- *only for indoor usage*

EM15 (40÷250W)

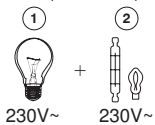

EM12 (40÷300W)

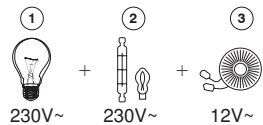

EM13 (0÷60W), EM14 (0÷180W),
EM23 (15÷250W, 15÷200VA),
EM18 (2÷250VA (3=10÷250VA), 2÷250W)

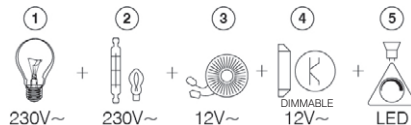

- 1 – Glühlampe / incandescent lamp
- 2 – Halogenlampe / halogen lamp
- 3 – Klassischer Transformator / classical transformer
- 4 – Dimmbarer elektronischer Transformator / dimmable electronic transformer
- 5 – Dimmbare LED-Lampe / dimmable LED lamp

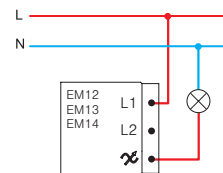
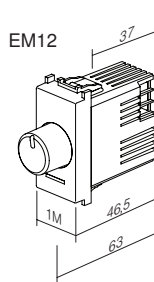
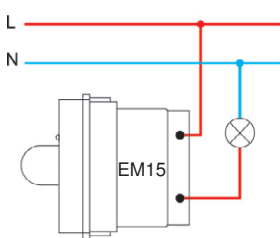
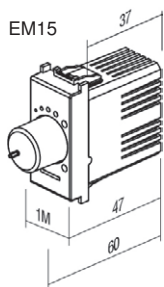

EM23

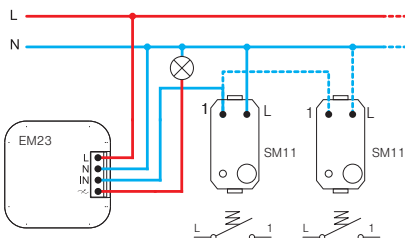
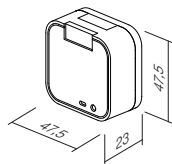

EM13, EM14

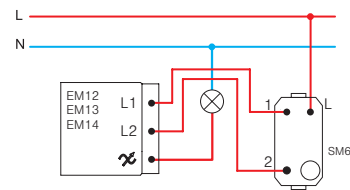
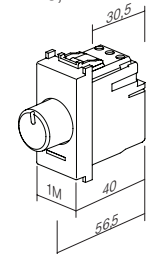

EM18

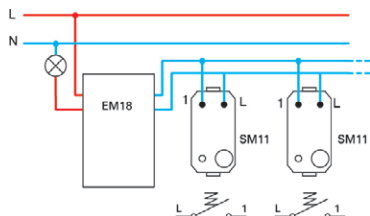
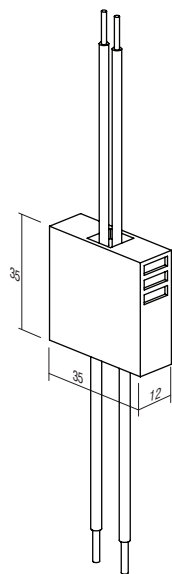

EM19

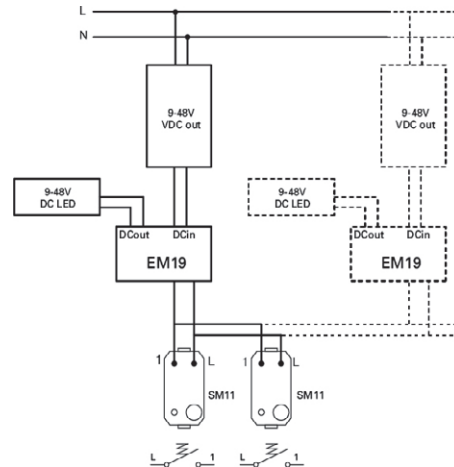
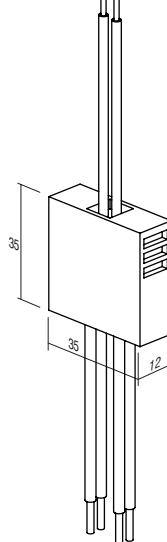

VORSICHT!

Bei der Montage von mehreren Dimmern in einer Dose verringert sich die maximale Gesamtleistung um 10 % für jeden zusätzlichen Dimmer.

ATTENTION!

If more dimmers are connected in one box reduce maximum common power for 10% for each dimmer.

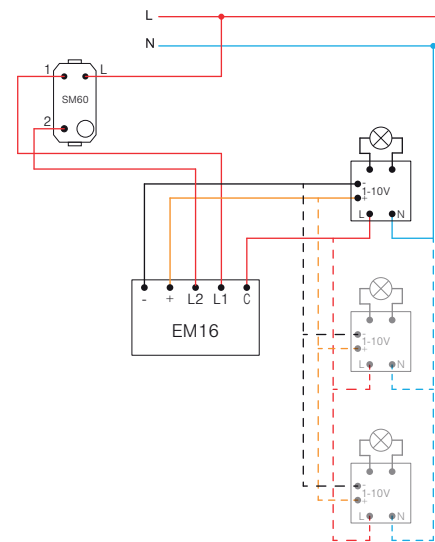
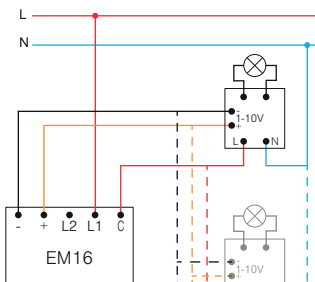
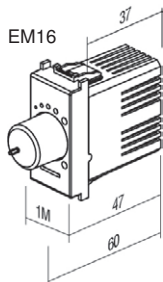
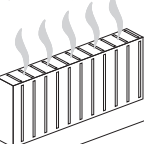

SCHALTER/DIMMER UNIVERSAL RLC 0-300W 2M

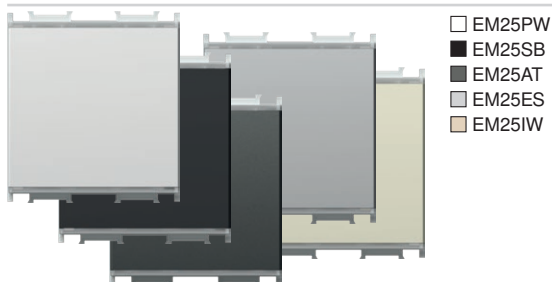

- EM25PW
- EM25SB
- EM25AT
- EM25ES
- EM25IW

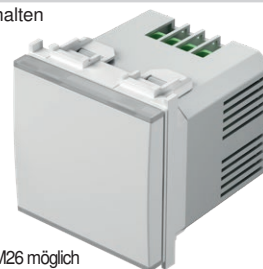

TOUCH EM25 ist ein Mikroprozessor-Gesteuerter elektronischer Dimmer. Es ermöglicht das Ein-/Ausschalten und Dimmen von allen dimmbaren und einigen nicht dimmbaren Lampen und Leuchtmitteln. Der eingebaute Mikroprozessor erkennt automatisch den Lampentyp und passt entsprechend die Betriebsart an. Die integrierte Speicherfunktion ermöglicht beim Ausschalten des Dimmers die Speicherung der letzten Einstellung. Die Soft-Ein-/Aus-Funktion verlängert die Lebensdauer der Lampen. In der Dimmertaste ist eine hochelegante LED zur Beleuchtung mit verschiedenen Einstellungsmöglichkeiten (Farbe und Intensität) integriert. Schaltung von bis zu 5 zusätzlichen Kontrollschalter EM26 möglich (»Slave«).

TOUCH EM25 is microprocessor controlled electronic light dimmer. It serves as switch and dimmer for dimmable and some of non-dimmable lamps. Integrated microprocessor automatically identifies the type of lamp and adjusts the operating mode. It remembers the level of dimming after switching off due to integrated memory function. Soft-start function extends the lamp service life. In button integrated elegant LED illumination enables many different colours and intensity levels. Optionally one can connect up to 5 additional control tasters EM26 (»slave«).

- Elektronischer Universaldimmer zum Ein-/Ausschalten und Dimmen von allen dimmbaren Lampen und Leuchtmitteln (klassische, Halogenlampen, LED, CFL usw.) und einigen nicht dimmbaren Leuchtmitteln.
- erkennt automatisch den Lampentyp und passt entsprechend die Betriebsart an
- durch die Verdunkelung verringert sich der Stromverbrauch
- die Soft-Ein/Aus-Funktion verlängert die Lebensdauer der Lampen
- Regelung über integrierte Mikroswitcher
- Speicherfunktion integriert (speichert den Dimmwert beim Ausschalten)
- Schaltung von bis zu fünf (5) zusätzlichen Kontrollschalter EM26 möglich
- kann nicht mit Wechselschalter verbunden werden
- integrierter Kurzschluss-, Überhitzungs- und Überlastungsschutz
- Versorgung 230 V~ 50 Hz
- hochelegante LED für Beleuchtung, mit Einstellmöglichkeit (Farbe und Intensität)
- Wechselmöglichkeit für klassische Schalter – Zweileiterschaltung(1)
- die volle Funktionalität des Dimmers wird durch die Dreileiterschaltung erreicht
- entspricht EN 60669-1 und EN 60669-2-1
- Schraubklemmen 1,5 mm² (max. Kraft zum Festziehen der Schrauben 0,4 Nm)

SWITCH / DIMMER UNIVERSAL RLC 0-300W 2M

- universal electronic dimmer for ON/OFF switching and dimming of all dimmable lamps (classical, halogen, LED, CFL, ...) and some non-dimmable lamps
- automatic detection of lamp type and adjustment of operating mode
- reduction of energy consumption
- soft start function extends life of lamps
- controlled by build-in micro switches
- memory function included – memorizes brightness on turn-off
- up to five (5) additional control units EM26 can be connected
- connection with 2-way switch is not possible
- build-in short-circuit, overheating and overload protection
- supply voltage 230V~ 50Hz
- elegant LED illumination, adjustable colour and brightness
- replacement of classical switch is possible at two-wire connection⁽¹⁾
- full functionality is achieved at three-wire connection⁽²⁾
- in accordance with EN 60669-1 and EN 60669-2-1
- screw contacts 1.5mm² (max. tightening torque 0.4Nm)

(1)Zweileiterschaltung
two-wire connection

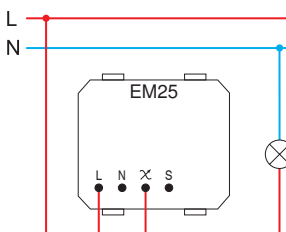

- die Zweileiterschaltung ermöglicht das Dimmen von dimmbaren Lampen und Leuchtmitteln.
- two-wire connection allows dimming of dimmable lamps

(2)Dreileiterschaltung
three-wire connection

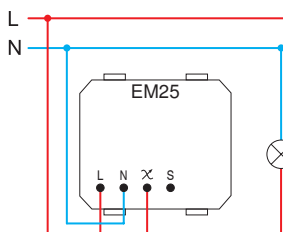

- die Dreileiterschaltung ermöglicht das Dimmen von dimmbaren Lampen und Leuchtmitteln und einigen nicht dimmbaren LED- und CFL-Lampen.
- three-wire connection allows dimming of dimmable lamps and some of non-dimmable LED and CFL lamps

	1	2	5	6	7
Min.	40 W	40 W	40 VA	40 VA	40 VA
Max.	300 W	300 W	300 VA	100 VA	100 VA
	(F)	(F)	(F)		

- 1 – Glühlampe / incandescent lamp
- 2 – Halogenlampe / halogen lamp
- 4 – dimmbare elektronischer Transformator / dimmable electronic transformer
- 5 – klassischer Transformator / classical transformer

	1	2	4	6	7	8	9
Min.	0 W	0 W	0 VA	0 VA	0 VA	0 VA	0 VA
Max.	300 W	300 W	120 VA	120 VA	120 VA	120 VA	120 VA
	(F)	(F)	(F)			(F)	(F)

- 6 – dimmbare Energiesparlampe CFL / dimmable energy saving CFL lamp
- 7 – dimmbare LED-Lampe / dimmable LED lamp
- 8 – nicht dimmbare Energiesparlampe CFL / non-dimmable energy saving CFL lamp
- 9 – nicht dimmbare LED-Lampe / non-dimmable LED lamp

Anmerkungen / remarks

- (F) Filter EM27
- Wir empfehlen die Verwendung eines Filters EM27 / it is recommended to use filter EM27
- Alle gesteuerten Lampen und Leuchtmittel müssen gleich sein / all controlled lamps must be the same
- Die Belastungstabelle gilt für Lampen mit Faktor PF > 0,5 / table of loads is valid for lamps with power factor PF>0.5

Ein-/Ausschalten und Dimmen der Lichter /
on / off swithcing and dimming of lamp

Farbauswahl und Einstellung der
LED-Beleuchtungsintensität /
LED colour selection and intensity level adjustment

RESET-Funktion /
"RESET" function

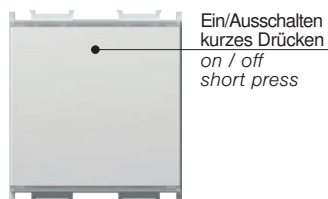

Ein/Ausschalten
kurzes Drücken
on / off
short press



Ausschalten der Lichter
kurzes Drücken
lamp off
short press

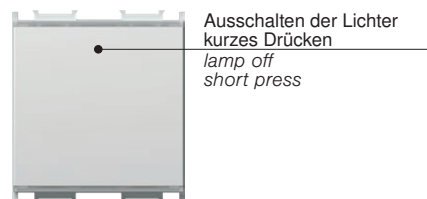

Ausschalten der Lichter
kurzes Drücken
lamp off
short press



Beleuchtung
längeres
Drücken
dimming up
long press

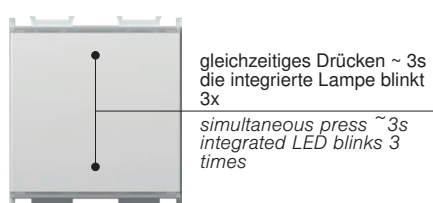

gleichzeitiges Drücken ~ 3s
die integrierte Lampe blinkt
3x
simultaneous press ~ 3s
integrated LED blinks 3
times

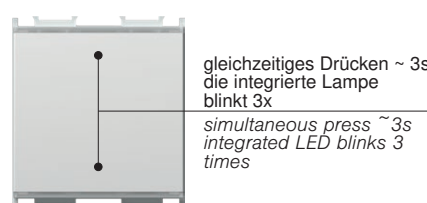

gleichzeitiges Drücken ~ 3s
die integrierte Lampe
blinkt 3x
simultaneous press ~ 3s
integrated LED blinks 3
times

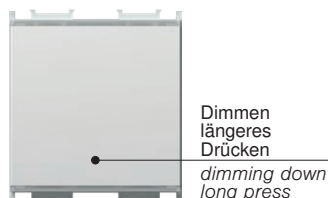

Dimmen
längeres
Drücken
dimming down
long press

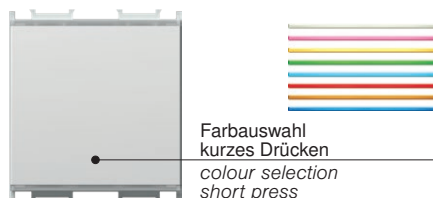

Farbauswahl
kurzes Drücken
colour selection
short press

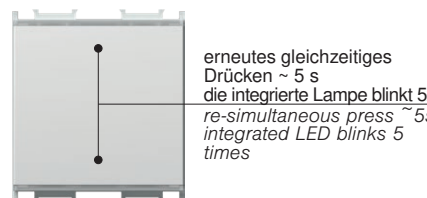

erneutes gleichzeitiges
Drücken ~ 5 s
die integrierte Lampe blinkt 5x
re-simultaneous press ~ 5s
integrated LED blinks 5
times

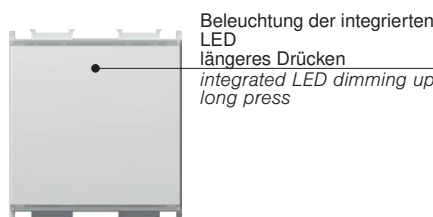

Beleuchtung der integrierten
LED
längeres Drücken
integrated LED dimming up
long press

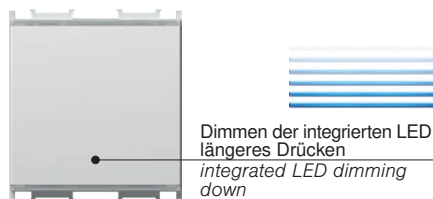

Dimmen der integrierten LED
längeres Drücken
integrated LED dimming
down
long press

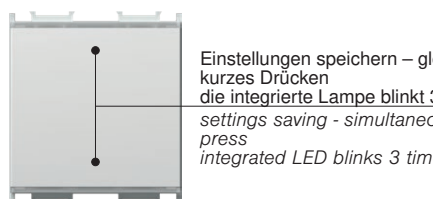

Einstellungen speichern – gleichzeitiges
kurzes Drücken
die integrierte Lampe blinkt 3x
settings saving - simultaneous short
press
integrated LED blinks 3 times

- * - wir empfehlen beim Einbau des Dimmers und beim Wechsel der Lampen und Leuchtmittel diese Funktion durchzuführen
- unbedingt notwendig bei Verwendung von nicht dimmbaren Lampen
- die RESET-Funktion ist bei der Zweileiterschaltung nicht anwendbar
- nur bei EM25 möglich
- it is recommended at dimmer installation and lamp replacement
- mandatory when using non-dimmable lamps
- "RESET" function is not possible when using two-wire connection
- only possible on EM25

Einbauhinweise /
installation precautions

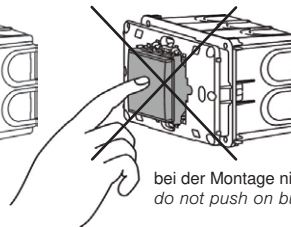
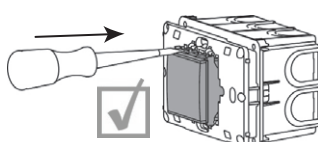
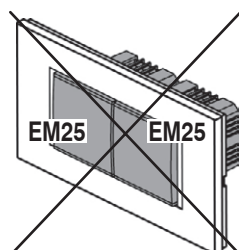
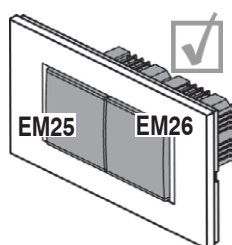

bei der Montage nicht die Taste betätigen/
do not push on button during mounting

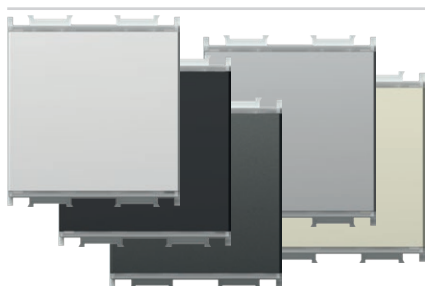

- EM26PW
- EM26SB
- EM26AT
- EM26ES
- EM26IW

KONTROLLTASTER 2M

- in Verbindung mit dem Universaldimmer EM25 ermöglicht dieser Taster die Bedienung der Beleuchtung aus mehreren (bis zu 5) Standorten mit der gleichen Funktionalität als EM25
- Versorgung 230 V~ 50 Hz
- entspricht EN 60669-1 und EN 60669-2-1
- Schraubklemmen 1,5 mm² (max. Kraft zum Festziehen der Schrauben 0,4 Nm)

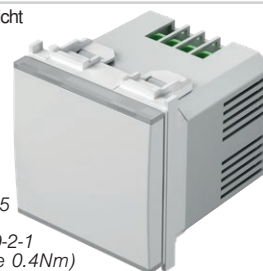

PUSH-BUTTON CONTROL UNIT 2M

- connected to universal dimmer EM25 allows controlling of lamps with same functionality as EM25
- supply voltage 230V~ 50Hz
- in accordance with EN 60669-1 and EN 60669-2-1
- screw contacts 1.5mm² (max. tightening torque 0.4Nm)

⁽¹⁾Zweileiterschaltung
two-wire connection

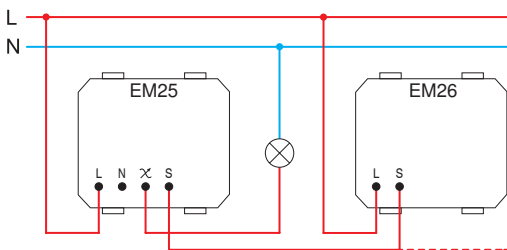

- die Zweileiterschaltung ermöglicht das Dimmen von dimmbaren Lampen und Leuchtmitteln.
- im Falle der Zweileiterschaltung wird durch jeden zusätzlichen Kontrolltaster die Minimalbelastung um 25 W vergrößert.
- two-wire connection allows dimming of dimmable lamps
- in a two-wire connection each additional control unit increases the minimum load by 25W

⁽²⁾Dreileiterschaltung
three-wire connection

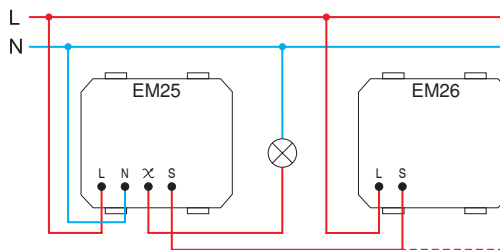

- die Dreileiterschaltung ermöglicht das Dimmen von dimmbaren Lampen und Leuchtmitteln und einigen nicht dimmbaren LED- und CFL-Lampen.
- three-wire connection allows dimming of dimmable lamps and some of non-dimmable LED and CFL lamps

STÖRUNGSFILTER



EM27

- Filter für Frequenzstörungen für EM25
- die Abbildung ist symbolisch

FREQUENCY FILTER

- frequency filter for EM25
- image is symbolic

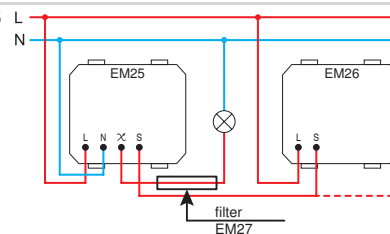

SET SCHALTER/DIMMER UNIVERSAL RLC 0-300W 2M PP OL20

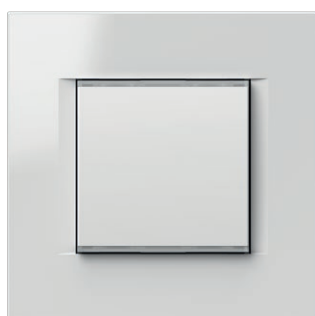

□ EM25PPOL20

- Set aus Dimmer EM25, Montageträger 2M und Rahmen LINE 2M PW
- siehe technische Beschreibung EM25

SET SWITCH / DIMMER UNIVERSAL RLC 0-300W 2M PP OL20

- set includes dimmer EM25, mounting frame 2M and cover plate LINE 2M PW
- for technical details see EM25



2M = 45 x 45

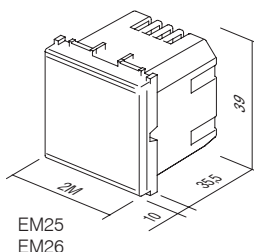

EM25
EM26

IR-SCHALTER 5A 230V~ 1M



- EM31PW
- EM31SB
- EM31AT
- EM31ES
- EM31IW

- IR-Schalter
- Versorgung: 230V~ ±10 % 50Hz
- Relais: 5A / 250V~ (Nulldurchgang)
- Schutzart: IP40
- Schraubklemmen: 0,75–2,5 mm²
- Erfassungswinkel: bis 110° bei 20°C
- Erfassungsbereich: ca. 8 m bei 20°C
- Einstellung der Beleuchtungszeit: von ca. 5 s bis 12 min
- Beleuchtungseinstellung: von ca. 5 bis 200 Lx
- Betriebstemperatur: von 0°C bis + 40°C
- nicht geeignet für den Einbau in Dosen mit Tiefe 45 mm und Gehäuse CUBO IP20
- nur für Gebrauch im Innenbereich



IR SWITCH 5A 230V~ 1M

- IR infrared switch
- supply voltage: 230V~ ±10 % 50Hz
- relay: 5A / 250V~ (zero crossing)
- protection rating: IP40
- cross-section of wires at the contact terminal: 0.75 - 2.5 mm²
- detection angle: up to 110° at 20°C
- detection area: approx. 8 m at 20°C
- adjustability of duration: from approx. 5 s to 12 min
- adjustability of brightness: from approx. 5 to 200 LUX
- operating temperature: from 0°C to +40°C
- not suitable for installation in 45 mm deep boxes and surface mount box CUBO IP20
- only for indoor usage

IR-SCHALTER 5A 230V~ 2M

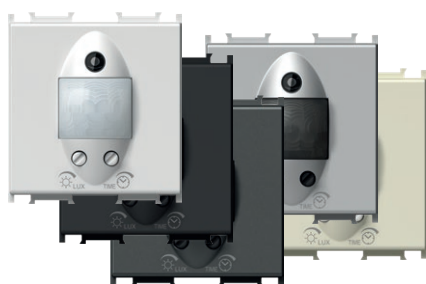

- EM32PW
- EM32SB
- EM32AT
- EM32ES
- EM32IW

- IR-Schalter
- Versorgung: 230V~ ±10 % 50Hz
- Relais: 5A / 250V~ (Nulldurchgang)
- Schutzart: IP40
- Schraubklemmen: 0,75–2,5 mm²
- Erfassungswinkel: bis 110° bei 20°C
- Erfassungsbereich: ca. 8 m bei 20°C
- Einstellung der Beleuchtungszeit: von ca. 5 s bis 12 min
- Beleuchtungseinstellung: von ca. 5 bis 200 Lx
- Betriebstemperatur: von 0°C bis + 40°C
- nicht geeignet für den Einbau in Dosen mit Tiefe 45 mm und Gehäuse CUBO IP20
- nur für Gebrauch im Innenbereich



IR SWITCH 5A 230V~ 2M

- IR infrared switch
- supply voltage: 230V~ ±10 % 50Hz
- relay: 5A / 250V~ (zero crossing)
- protection rating: IP40
- cross-section of wires at the contact terminal: 0.75 - 2.5 mm²
- detection angle: up to 110° at 20°C
- detection area: approx. 8 m at 20°C
- adjustability of duration: from approx. 5 s to 12 min
- adjustability of brightness: from approx. 5 to 200 LUX
- operating temperature: from 0°C to +40°C
- not suitable for installation in 45 mm deep boxes and surface mount box CUBO IP20
- only for indoor usage

Erfassungsbereich/
detection range

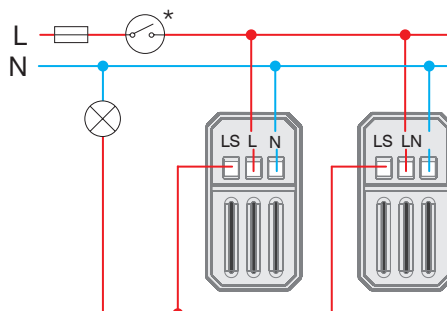
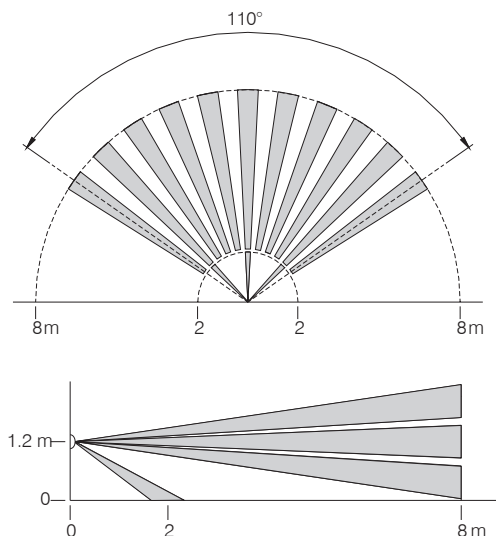

E L E C T R O N I C S E M

Einstellung der Lichtempfindlichkeit und der Beleuchtungszeit/
time and twilight adjustment

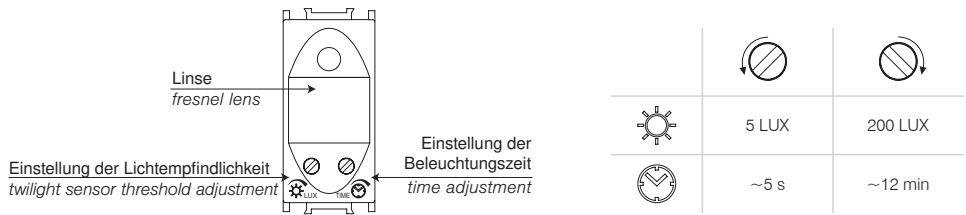

	1	2	3	4	5	6	7	8
Min.	1 W	1 W		1 VA	1 W	1 W	1 VA	1 VA
Max.	800 W	800 W	5A	6x20 VA	6x36 W	4x36 W (20µF)	6x23 VA	6x20 VA
1 – Glühlampe / incandescent lamp		2 – Halogenlampe / halogen lamp	3 – Widerstandsheizelement / resistive heating element	4 elektronischer Transformator/ electronic transformer	5 – Leuchtstoffröhre (Ausführung 1) / fluorescent tube (version 1)	6 – Leuchtstoffröhre (Ausführung 2) / fluorescent tube (version 2)	7 – Energiesparlampe CFL energy saving CFL lamp	8 – LED-Lampe/ LED lamp

Hinweise /
attention

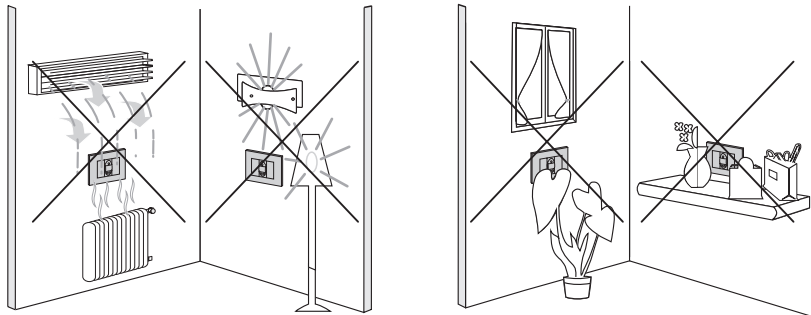

1M = 22,5 x 45

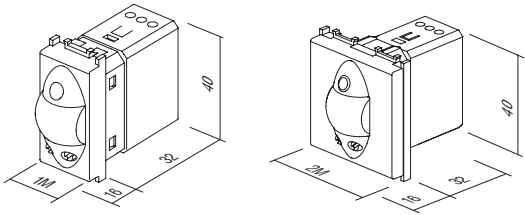

ELEKTRONISCHES THERMOSTAT 6A 250V~ 2M



- EM37PW
- EM37SB
- EM37AT
- EM37ES
- EM37IW

- elektronisches Thermostat
- Betriebsart: Heizung / Kühlung / Aus
- Versorgung: 230 VAC, 50 Hz
- Ausgang: 6(2) A, 230 VAC, Umschaltrelais
- Regulierungsbereich: +10 °C bis +30 °C
- Hysterese: ±0,5 °C, ED = 20min
- Frostschutz (Betriebsart Heizung): + 6 °C
- Überhitzungsschutz (Betriebsart Kühlung): + 32 °C
- ECO-Funktion zur Temperatursenkung um 3 °C für 6 Stunden in der Betriebsart Heizung und Temperaturerhöhung um 3 °C für 6 Stunden in der Betriebsart Kühlung
- jeden Tag erfolgt um die gleiche Zeit automatisch eine Temperaturreduzierung für 3 °C für 6 Stunden in Betriebsart Heizung oder eine Temperaturerhöhung für 3 °C für 6 Stunden in Betriebsart Kühlung
- Möglichkeit zum externen Einschalten der ECO-Betriebsart über einen separaten Eingang
- LED-Betriebsanzeige
- nicht geeignet für elektrische Fußbodenheizung
- Schraubklemmen max. 2,5 mm²
- entspricht der LV- und EMC-Richtlinie sowie EN60730-1 und EN60730-2-9
- zur korrekten Funktion empfehlen wir den Einbau in eine separate Dose, getrennt von Wärme erzeugenden Geräten
- Anwendungstemperatur: 5-35 °C
- Lagertemperatur: -20 bis 50 °C



Das Thermostat ist zur Regulierung der Raumtemperatur bestimmt. Es ermöglicht zwei Betriebsarten – Heizung und Kühlung. Das Thermostat ist mit zwei Schutzfunktionen ausgestattet – Frostschutz (Betriebsart Heizung) und Überhitzungsschutz (Betriebsart Kühlung) und einer LED-Betriebsanzeige. Die Einstellung erfolgt durch Drehen des Drehknopfes zur Temperatureinstellung und durch Betätigung der kapazitiven Berührungstasten.

The thermostat is intended for regulating temperature in a room. A thermostat enables two modes of operation – heating or cooling. It has safety functions installed for protection against freezing (heating mode) and protection against overheating (cooling mode). The operation is indicated via LED lights. Thermostat setup is performed with the help of a rotary button for setting the temperature and with other capacitive touch buttons.

THERMOSTAT BASIC 6A 230 V ~ 2M

- electronic thermostat, basic
- operation mode: heating/cooling/turn off
- power supply: 230 VAC, 50 Hz
- output: 6(2) A, 230 VAC, relay switch
- regulation range: +10 °C to +30 °C
- hysteresis: ±0.5 °C, ED = 20min
- anti-freeze protection (heating mode): +6 °C
- overheating protection (cooling mode): +32 °C
- ECO function for lowering the temperature by 3 °C for 6 hours in the heating mode and raising temperature by 3 °C for 6 hours in the cooling mode
- adaptive ECO function, automatically every day at the same time lowers the temperature by 3 °C for 6 hours in the heating mode and raises temperature by 3 °C for 6 hours in the cooling mode
- option to turn on the ECO operating mode by external trigger via a separate input
- LED indication of operation
- not suitable for electrical floor heating
- screw contacts max. 2.5 mm²
- in accordance with the LV Directive, the EMC Directive, standards EN60730-1 and EN60730-2-9
- for correct operation, we recommend installing in an independent single box, separate from devices that generate heat
- operating temperature: 5 ÷ 35 °C
- storage temperature: -20 ÷ 50 °C

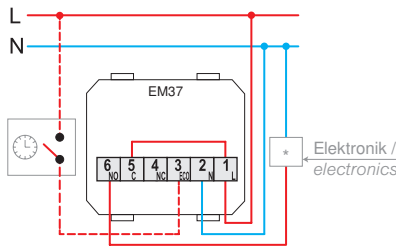

Umlaufpumpe, Brenner (Direktanschluss), thermoelektrischer Antrieb / circulation pump, burner (direct connection) thermoelectric drive

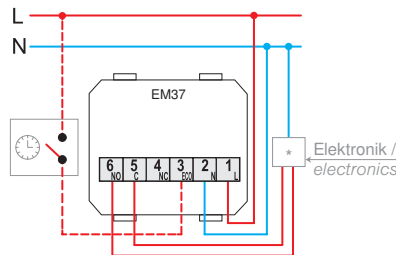

Kessel, Umlaufpumpe, Brenner (Steuereingang T1/T2)/ boiler, heat pump, burner (control input T1/T2)

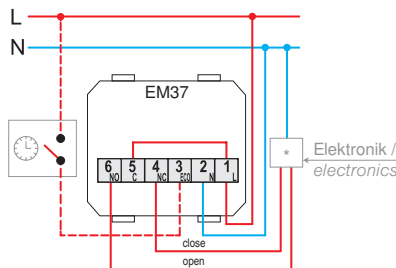

Motorantrieb (begrenzte Verwendung bei Fußbodenheizung)/ motor drive (limited use with underfloor heating)

Einstellung der Betriebsart und der Temperatur / function and temperature adjustment

Taste zur Betriebsartauswahl und LED-Zustandsanzeige:
rot: Heizung
blau: Kühlung
leuchtet nicht: ausgeschaltet

function selection button and LED status indicator:
red: heating
blue: air conditioning
no light: switched off

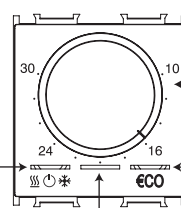

Einstellung der Temperatur / temperature setting

Taste zur Auswahl der ECO-Betriebsart und LED-Indikator der ECO-Betriebsart:
grün: ECO-Betriebsart ein
orange: adaptive ECO-Betriebsart ein
leuchtet nicht: Tagesablauf

“ECO” function selection button and LED “ECO” status indicator
green: ECO energy saving ON
orange: adaptive ECO mode activated
no light: day mode

LED-Indikator des Ausgangsrelais:
weiß: Ausgangsrelais ein
leuchtet nicht: Ausgangsrelais aus

LED output relay state indicator
white: relay ON
no light: relay OFF

Hinweise/ attention

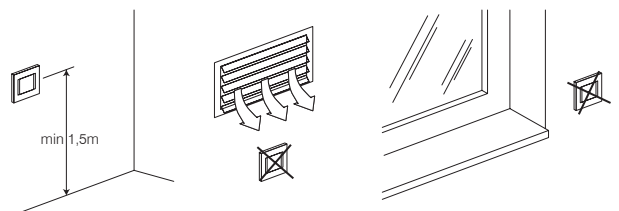

HEIZUNGSTHERMOSTAT 5(2)A 230V~ 2M

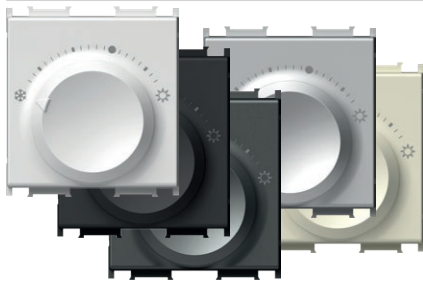

- EM38PW
- EM38SB
- EM38AT
- EM38ES
- EM38IW

- Betriebsart: Heizung
- Versorgung: 230 VAC, 50 Hz
- Spannungsimpuls: 4 kV
- Energieverbrauch: < 0,5 W
- Ausgang: 2 A (max. 5 A), 230 VAC, 50 Hz
- Ausgangsanschluss: NG (max. 10 Aktoren)
- Regelungsbereich: +5 °C bis +30 °C
- Frostschutz: +5 °C
- Hysterese: 0,5 K
- Schutz: IP30
- Sensorart: Bimetall
- elektrischer Anschluss Steckklemmen
- Leitung Typ: 0,75 - 1,5mm² (weich); 1,0 - 2,5 mm² (hart)



HEATING THERMOSTAT 5(2)A 230V~ 2M

- operation mode: heating
- power supply: 230 VAC, 50 Hz
- voltage pulse: 4 kV
- energy consumption: < 0.5 W
- output: 2 A (max. 5 A); 230 VAC, 50 Hz
- switching output: NO (max. 10 actuators)
- regulation range: +5°C to +30°C
- frost protection: +5°C
- hysteresis: 0.5 K
- protection: IP30
- sensor type: Bimetal
- type of electrical connection: Spring-loaded contacts
- type of conductors: 0.75 - 1.5 mm² (flexible-stranded core); 1.0 - 2.5 mm² (solid core)
- in compliance with Directive DIN EN 60730

HEIZUNGS-/KÜHLUNGSTHERMOSTAT 3(1,5) A 230 V~ 2 M

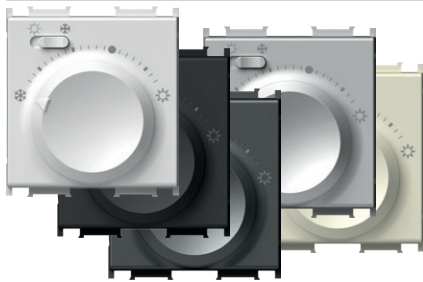

- EM39PW
- EM39SB
- EM39AT
- EM39ES
- EM39IW

- Betriebsart: Heizung / Kühlung
- Versorgung: 230 VAC, 50 Hz
- Spannungsimpuls: 4 kV
- Energieverbrauch: < 0,5 W
- Ausgang: 1,5 A (max. 3 A); 230 VAC, 50 Hz
- Ausgangsanschluss: Umschalter (max. 5 Aktoren)
- Regelungsbereich: +5 °C bis +30 °C
- Frostschutz: +5 °C
- Hysterese: 0,5 K
- Schutz: IP30
- Sensorart: Bimetall
- elektrischer Anschluss Steckklemmen
- Leitung Typ: 0,75 - 1,5mm² (weich); 1,0 - 2,5 mm² (hart)
- in Übereinstimmung mit der Richtlinie DIN EN 60730



HEATING/COOLING THERMOSTAT 3(1.5)A 230V~ 2M

- operation mode: cooling/heating
- power supply: 230 VAC, 50 Hz
- voltage pulse: 4 kV
- energy consumption: < 0.5 W
- output: 1 A (max. 3 A); 230 VAC, 50 Hz
- switching output: mode selector switch (max. 5 actuators)
- regulation range: +5°C to +30°C
- frost protection: +5°C
- hysteresis: 0.5 K
- protection: IP30
- sensor type: Bimetal
- type of electrical connection: Spring-loaded contacts
- type of conductors: 0.75 - 1.5mm² (flexible-stranded core); 1.0 - 2.5 mm² (solid core)
- in compliance with the Directive DIN EN 60730

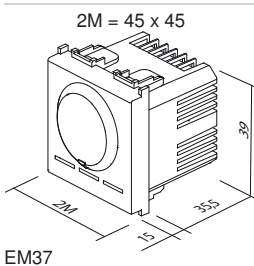

EM37

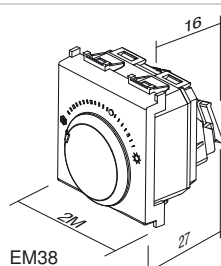

EM38

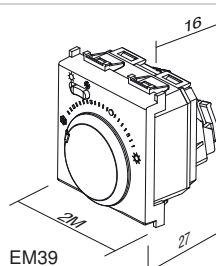

EM39

MONTAGETRÄGER MIT SCHRAUBEN FÜR THERMOSTATE FANTINI COSMI 3M

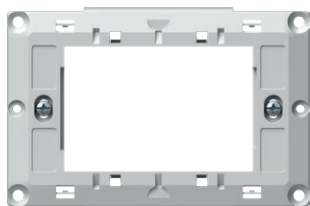

NM39

- Montageträger mit Schrauben für Thermostate Fantini Cosmi 3M
- bestimmt für die Verwendung mit Tages-Thermostaten Fantini Cosmi Modell CH121 und CH123
- bestimmt für die Verwendung mit Wochen-Thermostaten Fantini Cosmi Modell CH141A und CH143A
- Montage in Rechteckdosen 3M
- geeignet für Rahmen PURE, Line, Soft

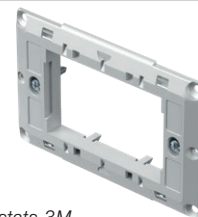

MOUNTING FRAME WITH SCREWS FOR FANTINI COSMI THERMOSTATS 3M

- mounting frame with screws for Fantini Cosmi thermostats 3M
- suitable for use with Fantini Cosmi daily thermostats models CH121 and CH123
- suitable for use with Fantini Cosmi weekly thermostats models CH141A and CH143A
- for mounting in rectangular boxes 3M
- suitable for assembling with cover plates PURE, Line, Soft

ENERGIESPAR-KARTENSCHALTER 3A 250V~ 3M



- EM40PW
- EM40SB
- EM40AT
- EM40ES
- EM40IW

- elektronischer Schalter aktiviert durch beliebige Standard-ISO-Karte
- Versorgung 230 V~ 50 Hz
- Ausgangsrelais 3A 250V~ für einen externen Lastschalter*
- Ausschaltungsverzögerung 15-20 s
- entspricht EN 61000-1
- ohne ISO-Karte, nicht zur Zutrittskontrolle bestimmt



ENERGY SAVER CARD SWITCH 3A 250V~ 3M

- card switch basic, any ISO card
- supply voltage 230V~ 50Hz
- output 3A 250V~ for switching contactor *
- switch off delay 15-20s
- in accordance with EN 61000-6-1
- card is not included
- not for access control

3M = 67,5 x 45

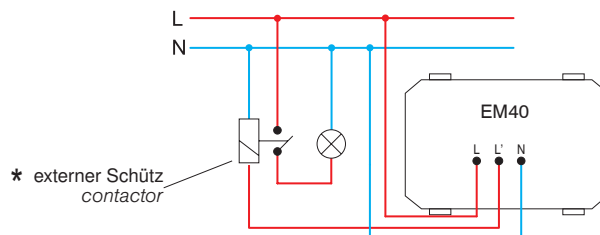
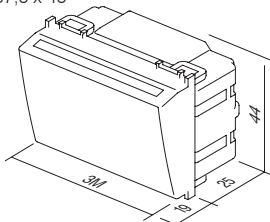

KARTE ISO

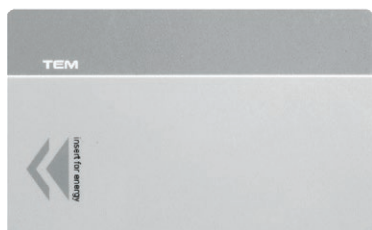

EM47

- KARTE ISO
- zur Verwendung mit Kartenschalter EM40
- Größe: 85x54 mm

CARD ISO

- ISO card
- for combination with card switch EM40
- size: 85x54 mm



EM44BK

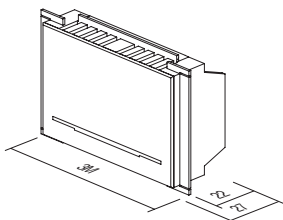

ENERGIESPAR-KARTENSCHALTER RF HF 13,56MHz 3M

- elektronischer Schalter aktiviert durch eine RFID-ISO-Karte
- Versorgung 5V von der Relaiseinheit EM49 über Kabel mit Anschlüssen RJ12
- Ausgang: Verbindung zur Relaiseinheit EM49
- Ausschaltverzögerung "main power" beim Ausziehen der Karte 15-20 s
- Ausschaltverzögerung "HVAC" beim Ausziehender Karte beim geöffneten Fenster oder Balkontür – 1 Minute
- entspricht EN 61000-1
- ohne ISO-Karte
- nicht zur Zutrittskontrolle bestimmt



ENERGY SAVER CARD SWITCH RF HF 13,56MHz 3M

- electronic card switch for RFID ISO card
- supply from relay unit EM49 through cable connectors RJ12
- output to be connected to relay output unit EM49
- 15-20s "main power" switch off delay with card withdrawal
- 1 min "HVAC" switch off delay with card withdrawal when balcony doors or windows opened
- in accordance with EN 61000-6-1
- card is not included
- not for access control

RELAISEINHEIT FÜR KARTENSCHALTER 2X16A 250V~

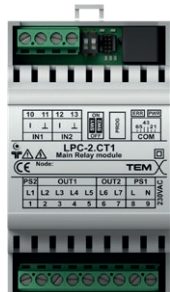

EM49

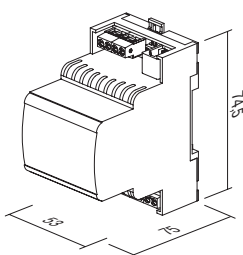

- Relaiseinheit für Kartenschalter EM44
- Versorgung 230 V~ 50 Hz
- entspricht EN 61000-1
- Montage auf eine DIN-Leiste 35mm, 3MU
- Ein- und Ausgänge im Bezug auf den Einbau: 1-zimmer oder 2-zimmer

ENERGY SAVER CONTROL UNIT 2x16A 250V~

- relay unit for card switches EM44
- supply voltage 230V~ 50Hz
- in accordance with EN 61000-6-1
- mounting on DIN rail 35mm, 3MU
- input and output depending on implementation: single or double room



KABELEINFÜHRUNG SPL-1



EM45

- zur Verbindung von zwei Kartenschalter EM44 mit Relaiseinheit EM49
- Kommunikationsanschluss RJ12
- Größe: 37 x 30 x 27 mm

SPLITTER SPL-1

- used to connect two peripheral modules EM44 to relay unit EM49
- communication connector RJ12
- size: 37 x 30 x 27 mm

Schaltschema für 1-zimmer-Betrieb / wiring diagram for single room implementation

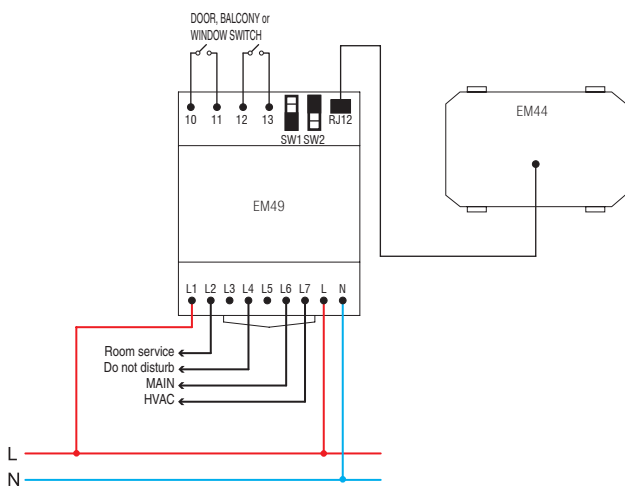

Schaltschema für 2-zimmer-Betrieb / wiring diagram for double room implementation

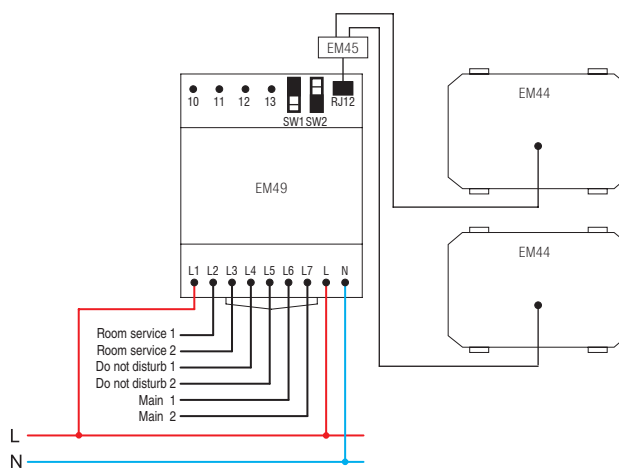

Verbindungskabel RJ12 zwischen EM44 und EM49 / connection cable RJ12 between EM44 and EM49

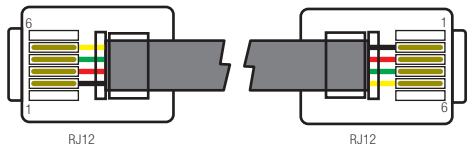

RASIERSTECKDOSE 230V~/120V~ 3M

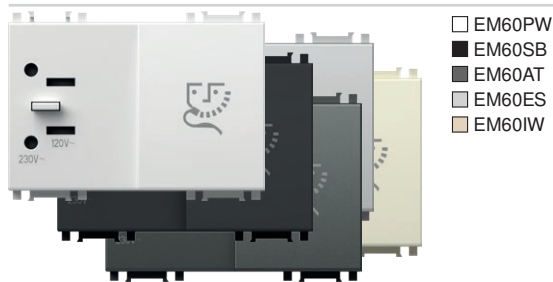

- EM60PW
- EM60SB
- EM60AT
- EM60ES
- EM60IW

- Einsatz für Rasierer mit Transformator 20VA
- Eingang: 230V~ 50-60Hz
- Ausgang:
 - 230V~ für 2P 2,5A-Eurostecker oder
 - 120V~ für 2P 15A amerikanischen Stecker
- Schutzklasse II
- entspricht EN 61558-5

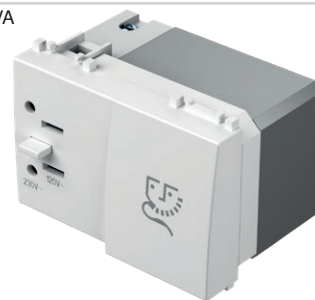

SOCKET SHAVER 230V~/120V~ 3M

- shaver supply unit with isolating transformer 20VA
- supply: 230V~ 50-60Hz
- output:
 - 230V~ for 2P 2.5A Europlug or
 - 120V~ for 2P 15A American plug
- Class II
- in accordance with EN 61558-2-5

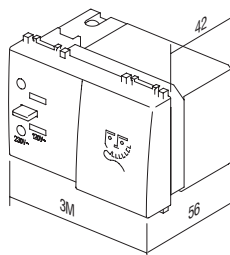

3M = 67,5 x 45

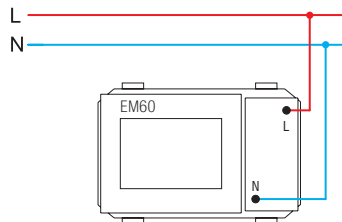

LADEGERÄT USB 5V 2,4A 1M



- EM67PW
- EM67SB
- EM67AT
- EM67ES
- EM67IW

- zum Laden der elektronischen Geräte über einen Standard-USB-Anschluss (kompatibel mit Apple-Geräten)
- Versorgung: 100-230 V~ 50/60 Hz
- Verbrauch im Betrieb:
 - 300 mA bei 100 V~/150 mA bei 230 V~
 - Verbrauch in Bereitstellung 30 mW bei 230 V~
- Ausgangsspannung 5 VAC (±5%) SELV
- Schwankungen der Ausgangsspannung 150 mV
- nominaler Ausgangsstrom 2,4 A (±10%)
- Nutzleistung: maximal 77%
- Betriebstemperatur: 0 °C/+45 °C (Gebrauch im Innenbereich)
- Schutzart: IP20, nur für Gebrauch im Innenbereich geeignet
- Schutzklasse des Gerätes II
- Überspannungsschutz (EN 62109): Klasse III
- Schraubklemmen max. 2,5 mm²
- Gerät mit einem Kontaktabstand von min. 3 mm
- entspricht EN 60950-1 und der LVD- und EMC-Richtlinien

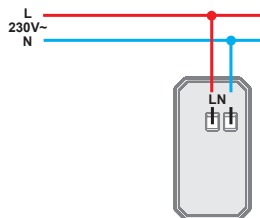
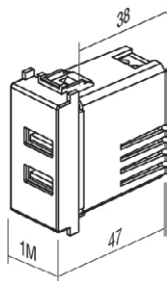

USB POWER SUPPLY UNIT 5V 2,4A 1M

- for charging of electronic devices via a standard USB port (also compatible with Apple devices)
- power supply: 100-230V~ 50/60Hz
- power consumption: 300mA at 100V~/150mA at 230V~
- standby power consumption: 30mW at 230V~
- nominal output voltage: 5 VCD (± 5%) SELV
- output ripple voltage: 150mV
- nominal output current: 2,4A (±10%)
- efficiency: maximum of 77%
- operating temperature: 0°C/+45°C (indoor use)
- IP protection class: IP20, indoor use only
- class device II
- overvoltage category (EN 62109): Class III
- screw contacts: max. 2.5 mm²
- device with a contact gap of at least 3mm
- in accordance with EN 60950-1 and LVD & EMC directives

LADEGERÄT USB 5V 3,0A



- EM68PW
- EM68SB
- EM68AT
- EM68ES
- EM68IW

- zum Laden der elektronischen Geräte über einen Standard-USB-Anschluss (kompatibel mit Apple-Geräten)
- Versorgung: 100 - 230 V~ 50 / 60 Hz
- Verbrauch während des Betriebs 300 mA bei 100 V~ / 150 mA bei 230 V~
- Verbrauch in Bereitstellung 30 mW bei 230 V~
- Ausgangsspannung 5 VDC (+/- 5%) SELV
- Schwankungen der Ausgangsspannung 150 mV
- nominaler Ausgangsstrom 3,0 A (±10%)
- Konnektortyp: USB A / USB C
- Nutzleistung: max. 77%
- Betriebstemperatur: 0°C / +45°C (im Innenbereich)
- Schutzart: IP20, nur für Gebrauch im Innenbereich geeignet
- Schutzklasse des Gerätes II
- Überspannungsschutz (EN 62109): Klasse III
- Schraubklemmen max. 2,5 mm²
- Gerät mit Kontaktversatz min. 3 mm
- entspricht EN 60950-1 und der EMC- und LVD-Richtlinie

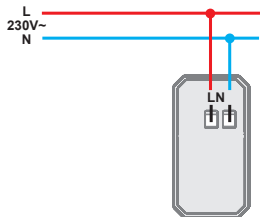
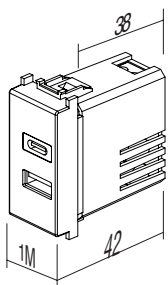

USB POWER SUPPLY UNIT 5V 3,0A

- for charging of electronic devices via a standard USB port (also compatible with Apple devices)
- power supply: 100-230V~ 50/60Hz
- power consumption: 300mA at 100V~/150mA at 230V~
- standby power consumption: 30mW at 230V~
- nominal output voltage: 5 VCD (± 5%) SELV
- output ripple voltage: 150mV
- nominal output current: 3,0 A (±10%)
- connector type: USB A / USB C
- efficiency: maximum of 77%
- operating temperature: 0°C/+45°C (indoor use)
- IP protection class: IP20, indoor use only
- class device II
- overvoltage category (EN 62109): Class III
- screw contacts: max. 2.5 mm²
- device with a contact gap of at least 3mm
- in accordance with EN 60950-1 and LVD & EMC directives

LED-NOTLEUCHTE 250V~ 0,9W, NiCd 3h 7M



- EM55

- LED-Notleuchte
- Versorgung 250V~ 50Hz 3x LED 0,3W 10000mcd, 6500K
- NiCd-Akku 400 mAh, auswechselbar
- 3h-Autonomie, Ladezeit 24 h
- Schutzklasse II
- entspricht EN 60598-1, EN 60598-2-2, EN 60598-2-22



LED EMERGENCY LIGHT 250V~ 0.90W, NiCd 3h 7M

- emergency LED lamp
- supply voltage 250V~ 50Hz 3x LED 0,3W, 10000mcd, 6500K
- NiCd accumulator 400 mAh, replaceable
- autonomy 3h, charging 24h
- Class II
- in accordance with EN 60598-1, EN 60598-2-2, EN 60598-2-22

7M = 151,5 x 45

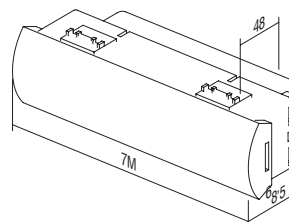
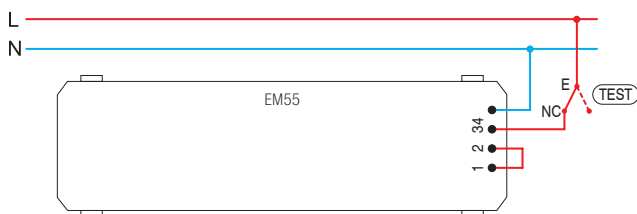

LED-NOTLEUCHTE 230V~50Hz, 0.5W, NiMH 2h 2M



- EM57

- LED-Notleuchte
- kann als tragbare Handlampe verwendet werden (ausziehbarer Mechanismus)
- Versorgung 230V~50Hz, 1xLED 0.5W
- NiMH-Akku 140mAh, auswechselbar
- 2h-Autonomie, Ladezeit 36h
- Schutzklasse II
- entspricht EN60598-1, EN60598-2-2, EN62471, EN55015:2006, EN61547

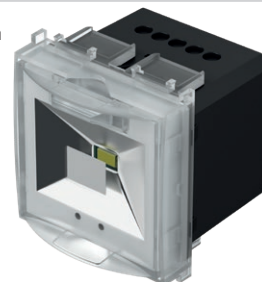

LED EMERGENCY LIGHT 230V~50Hz, 0.5W, NiMH 2h 2M

- emergency LED lamp
- option to use it as a hand lamp (pull-out mechanism)
- supply voltage 230V~ 50Hz, 1xLED 0.5W
- NiMH accumulator 140mAh, replaceable
- autonomy 2h, charging 36h
- class device II
- in accordance EN60598-1, EN60598-2-2, EN62471, EN55015:2006, EN61547

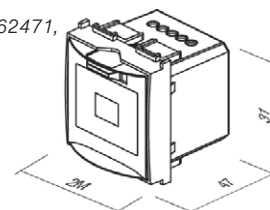
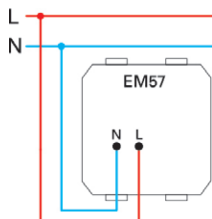

LED-LAMPE EINFARBIG 250V~ 0,8W 2M

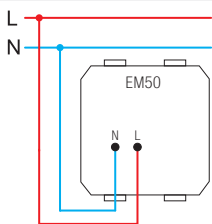

- EM50WH
- EM50BL
- EM50RD
- EM50GR

- LED-Lampe für Beleuchtung von Treppen und Gängen
- Versorgung 230V~ 50Hz 0,8W, 6500K
- Schutzklasse II
- entspricht EN 60598-1
- auch als Lenk- bzw. Signallampe verwendbar, Laserdruck-Möglichkeit von beliebigen Symbolen

LED LAMP MONOCOLOR 250V~ 0,8W 2M

- step marker LED lamp
- supply voltage 230V~ 50Hz 0,8W, 6500K
- Class II
- in accordance with EN 60598-1
- optional usage for directional or signal illumination with customized laser printing on diffuser



LED-LAMPE ZWEIFARBIG 250V~ 2x0,4W 2M

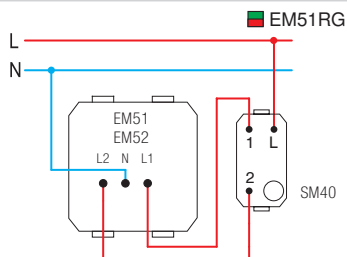

- EM51RG

- 2-farbige LED-Signallampe
- Versorgung 230V~ 50Hz 2x0,4W, 6500K
- Schutzklasse II
- entspricht EN 60598-1
- mit Symbol, wie auf dem Bild dargestellt
- Laserdruck-Möglichkeit von beliebigen Symbolen

LED LAMP DUAL COLOR 250V~ 2x0,4W 2M

- signaling dual color (red/green) LED lamp
- supply voltage 230V~ 50Hz 2x0,4W, 6500K
- Class II
- in accordance with EN 60598-1
- diffuser includes graphics as shown
- possible customized laser printing on diffuser



LED-LAMPE 3D ZWEIFARBIG 250V~ 2x0,4W 2M

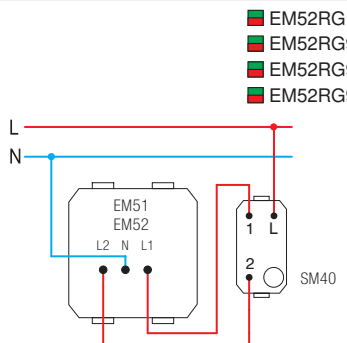

- EM52RG
- EM52RG90
- EM52RG91
- EM52RG99

- 2-farbige LED-Signallampe (rot/grün) mit 3D-Symbol
- Versorgung 230V~ 50Hz 2x0,4 W, 6500K
- Schutzklasse II
- entspricht EN 60598-1
- Druckmöglichkeit von verschiedenen Symbolen nach Bestellung
- 90 Männersymbol, 91 Frauensymbol, 99 Symbol nach Bestellung

LED LAMP 3D DUAL COLOR 250V~ 2x0,4W 2M

- signalling LED lamp, dual color (red/green) with 3D symbol
- supply voltage 230V~ 50Hz 2x0,4W, 6500K
- class II
- in accordance with EN 60598-1
- possible customized graphics on request
- 90 male symbol, 91 female symbol, 99 symbol on request

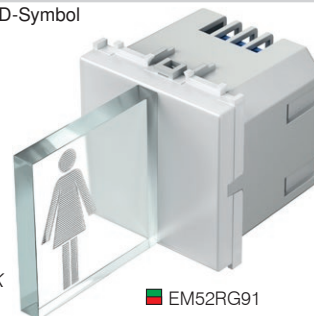

■ EM52RG91

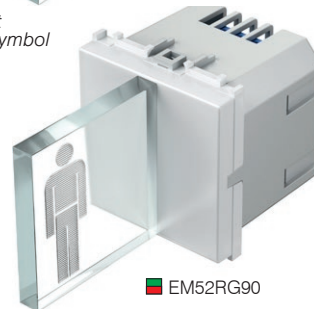

■ EM52RG90

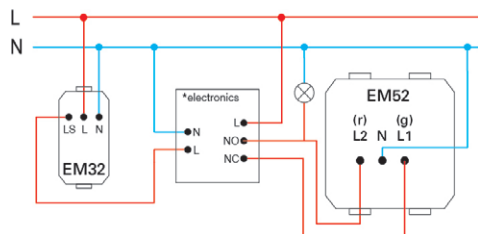

2M = 45 x 45

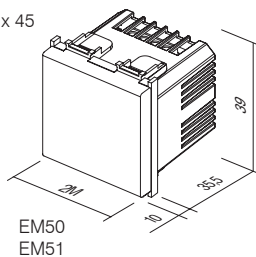

EM50
EM51

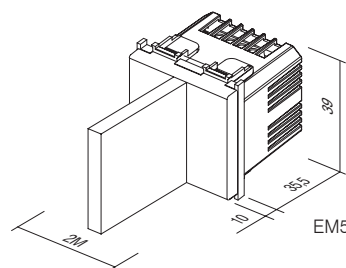

EM52



- EM71PW
- EM71SB
- EM71AT
- EM71ES
- EM71IW

FINGERABDRUCKLESER BIOPASS 2M

- Fingerabdruckschalter komplett mit Innen-Relaiseinheit und Netzteil
- Kapazität: 500 Fingerabdrücke
- einfache Bedienung über die mobile Anwendung X-Manager
- Versorgung: 8-30 V – DC oder AC (inkl. Netzteil)
- kapazitiver Sensor
- 2 Ausgangsrelais
- maximale Spannung/Strom am Relais: 40V/3A
- Auslösezeit des Relais: 1 - 10 s
- maximale Leistung 3,6 W
- 256-Bit-Verschlüsselung der Verbindung zwischen Schalter und der Innen-Relaiseinheit
- Das Set enthält auch den Träger NM24 und den dekorativen Rahmen OS20.



FINGERPRINT SWITCH BIOPASS 2M

- fingerprint switch with included internal relay unit and power supply
- capacity: 500 fingerprints
- easy management via X-Manager mobile app
- power supply voltage: 8-30V – DC or AC (power supply included)
- capacitive sensor
- 2 output relays
- maximum voltage/current on relay: 40V/3A
- relay triggering time: 1-10 sec
- maximum power: 3.6W
- 256-bit encrypted link between switch and internal relay unit
- Set also includes NM24 mounting frame and OS20 decorative cover plate.

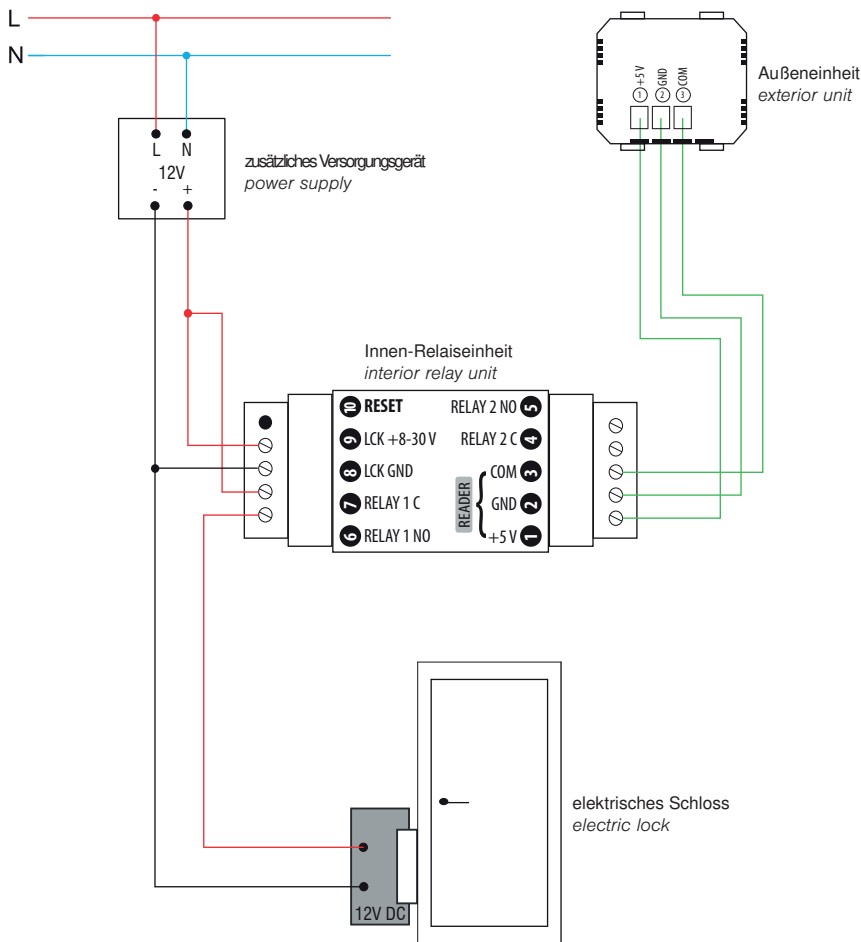

X-Manager app



support.tem.si



Außeneinheit exterior unit

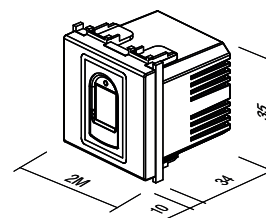

SCHALTER BERÜHRUNGSLOS 10A 240V~



EM80GW

- Ein-/Ausschalter berührungslos ("master")
- Versorgung: 240 V~ 50 Hz
- Ausgangsrelais 10A / 250V~ (2400W bei 240V~)
- Reichweite einstellbar von 2 bis 10 cm
- für die Montage in eine Standardmäßige Runddose mit einem Durchmesser von Ø60 mm
- zum Anschluss wird unbedingt ein Neutralleiter (N) benötigt kann nicht mit Wechselschalter verbunden werden
- Schaltung von bis zu 5 zusätzlichen Kontrollschalter EM81 möglich
- einfache Montage der Dekorrahmen mit Hilfe von Magneten
- Schraubklemmen 2,5 mm² (max. Kraft zum Festziehen der Schrauben 0,4 Nm)
- entspricht EN 60669-1 und EN 60669-2-1
- nur für Gebrauch im Innenbereich



SWITCH, TOUCHLESS 10A 240V~

- touchless switch for turning on/off ("master")
- power supply: 240 V~ 50 Hz
- output relay 10A / 250V~ (2400W at 240V~)
- adjustable range from 2 to 10 cm
- intended for installation into a standard round Ø60 mm box
- a neutral lead (N) is required for connection
- connection with toggle switches is not possible
- connection with up to 5 EM81 control switches is possible
- simple installation of decorative covers with the help of magnets
- screw fastening of leads up to 2,5 mm² (max. screw tightening torque is 0.4 Nm)
- in accordance with EN 60669-1 and EN 60669-2-1
- only for indoor use

KONTROLLSCHALTER BERÜHRUNGSLOS



EM81GW

- Kontrollschalter („Slave“)
- nur in Kombination mit Schalter EM80 („Master“)
- Reichweite einstellbar von 2 bis 10 cm
- einfache Montage der Dekorrahmen mit Hilfe von Magneten
- Schraubklemmen 2,5 mm² (max. Kraft zum Festziehen der Schrauben 0,4 Nm)
- entspricht EN 60669-1 und EN 60669-2-1
- nur für Gebrauch im Innenbereich



SWITCH, TOUCHLESS, CONTROL UNIT

- control switch ("slave")
- works only when connected with the EM80 switch ("master")
- adjustable range from 2 to 10 cm
- simple installation of decorative covers with the help of magnets
- screw fastening of leads up to 2.5 mm² (max. screw tightening torque is 0.4 Nm)
- in accordance with EN 60669-1 and EN 60669-2-1
- only for indoor use

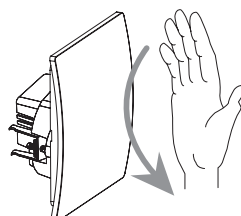
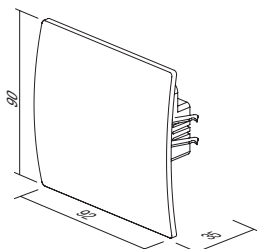
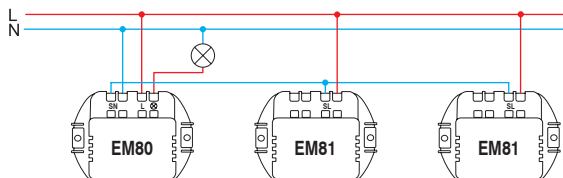
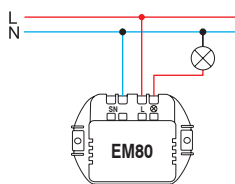

SUMMER 8VA 12V~ 1M

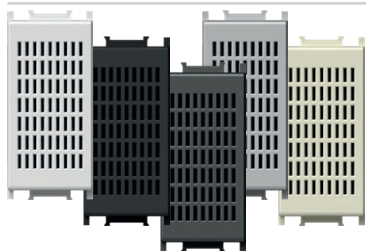

- EM91PW
- EM91SB
- EM91AT
- EM91ES
- EM91IW

- Signalsummer
 - der Klingelton dauert an, solange Sie auf die Taste drücken
 - Versorgung 12V~ 50Hz 8VA
- BUZZER 8VA 12V~1M**
- signal buzzer
 - the sound emission has the same lasting time as the control operation
 - supply voltage 12V~ 50Hz 8VA



KLINGEL 8VA 12V~ 1M

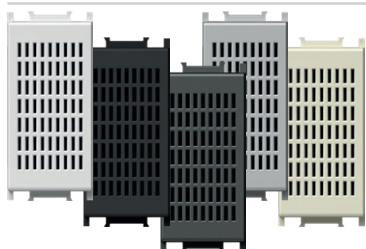

- EM93PW
- EM93SB
- EM93AT
- EM93ES
- EM93IW

- Signalklingel
 - der Klingelton dauert an, solange Sie auf die Taste drücken
 - Versorgung 12V~ 50Hz 8VA
- BELL 8VA 12V~1M**
- signal bell
 - the sound emission has the same lasting time as the control operation
 - supply voltage 12V~ 50Hz 8VA



KLINGEL 230V~ 6mA rms 1M

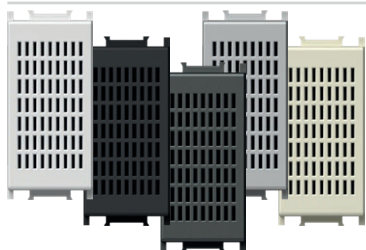

- EM94PW
- EM94SB
- EM94AT
- EM94ES
- EM94IW

- Versorgung 230 V~ 50/60 Hz
- Verbrauch bei Melodie 1: 4,7 mA RMS
- Verbrauch bei Melodie 2: 5,9 mA RMS
- Lautstärke bei Melodie 1: 90,5 dB
- Lautstärke bei Melodie 2: 86 dB
- Betriebstemperatur: 0 °C/45 °C (Gebrauch im Innenbereich)
- Lagertemperatur: -20 °C bis 50 °C
- Schutzart: IP20 (nur für Gebrauch im Innenbereich geeignet)
- Schutzklasse des Gerätes II
- Überspannungsschutz (EN 62109): Klasse III
- Schraubklemmen max. (2,5 mm²)
- Gerät mit Kontaktversatz min. 3 mm
- die Klingel muss mit einem geeigneten externen Schutzschalter geschützt werden
- entspricht der EMC- und LVD-Richtlinie



BELL 230V~ 6mA rms 1M

- power supply 230 V~ 50/60 Hz
- power consumption when playing melody 1: 4.7 mA rms
- power consumption when playing melody 2: 5.9 mA rms
- sound level of melody 1: 90.5 dB
- sound level of melody 2: 86 dB
- operating temperature 0°C/45°C (indoor use)
- storage temperature: -20°C /50°C
- IP protection class: IP20 (indoor use only)
- class device II
- overvoltage category (EN62109): Class III
- screw contacts: max. 2.5 mm²
- device with a contact gap of at least 3 mm
- an easily accessible cut-off switch must be installed upstream from bell
- complies with EMC & LVD directives

EM91
EM93
EM94

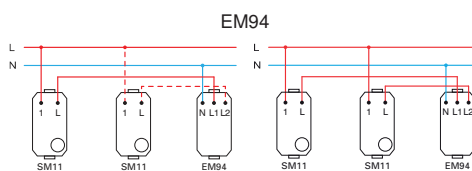
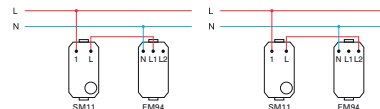
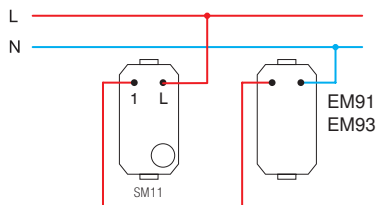
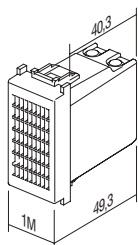

LAUTSTÄRKENREGLER FÜR 100 V AUDIOLINE 35W 2M



- EM95PW
- EM95SB
- EM95AT
- EM95ES
- EM95IW

- Lautstärkenregler (Attenuator) für 100 V Audiosysteme
- Nennleistung 35 W (max. 45 W), 6-stufige Lautstärkenregelung
- geeignet für den Einbau in tiefe Dosen (min. 60 mm)
- nicht geeignet für den Einbau in Dosen mit Tiefe 45 mm und Gehäuse CUBO IP20
- nur für Gebrauch im Innenbereich



VOLUME CONTROL 100V AUDIO LINE 35W 2M

- volume control (attenuator) for 100V audio systems
- power rating 35W (max.45W), 6 steps volume control
- suitable for boxes min. 60 mm deep
- not suitable for installation in 45 mm deep boxes and surface mount boxes CUBO IP20
- for indoor use only

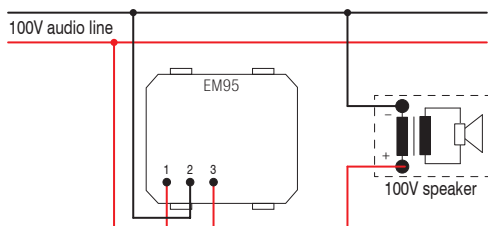

NIEDEROHMIGER LAUTSTÄRKENREGLER 4-8 Ω 35W 2M

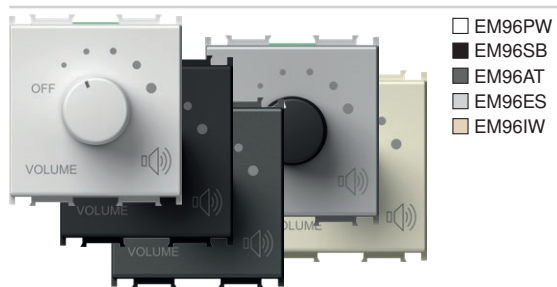

- EM96PW
- EM96SB
- EM96AT
- EM96ES
- EM96IW

- Lautstärkenregler für niederohmige Ausgänge 4-8 Ω 35W
- zum Anschluss an Hi-Fi-Geräte
- Nennleistung 35 W, 6-stufige Lautstärkenregelung
- geeignet für den Einbau in tiefe Dosen (min. 60 mm)
- nicht geeignet für den Einbau in Dosen mit Tiefe 45 mm und Gehäuse CUBO IP20
- nur für Gebrauch im Innenbereich



VOLUME CONTROL 4-8 Ω 35W 2M

- volume control (attenuator) for low voltage outputs 4-8 Ω, 35W
- power rating 35W, 6 steps volume control
- suitable for boxes min. 60 mm deep
- not suitable for installation in 45 mm deep boxes and surface mount boxes CUBO IP20
- for indoor use only

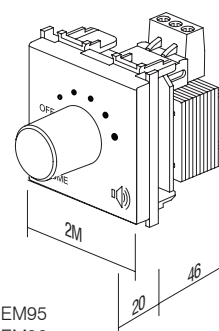
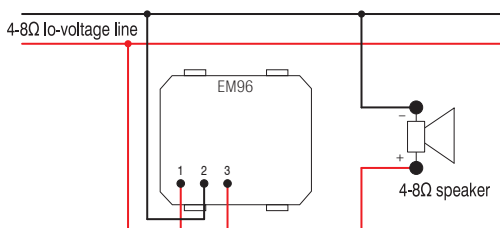

EM95
EM96



Typ type	Bezeichnung description	Technische Daten technical data	Größe size	Farbe colour	Optionsbezeichnung 1 optional data 1
CM10	SET STECKDOSEN 2x SCHUKO SOCKET SET 2x SCHUKO	2P+E 16A 250V~	4M	<input type="checkbox"/> PW weiß-glänzend polar white	<input type="checkbox"/> OL Rahmen LINE cover plate LINE
CM11	SET STECKDOSEN 3x SCHUKO SOCKET SET 3x SCHUKO	2P+E 16A 250V~	7M	<input checked="" type="checkbox"/> SB schwarz-matt soft touch black	<input type="checkbox"/> OS Rahmen SOFT cover plate SOFT
CM15	SET VERDRÄHTUNGSBRÜCKEN FARBIG 3x1.5mm ² LINK WIRE SET		1M	<input checked="" type="checkbox"/> AT anthrazit anthracite	
:	:	:	:	<input type="checkbox"/> ES silber-matt elox silver	
:	:	:	:	<input type="checkbox"/> IW beige-glanz ivory white	

SET STECKDOSEN 2x SCHUKO 2P+E 16A 250V~ 4M

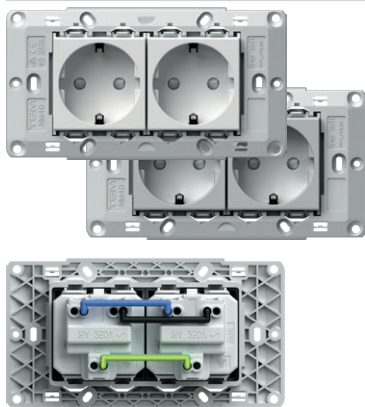

- CM10PW
- CM10ES

- Steckdosen-Set 2x Schuko VM10 2P+E 16A 250V~
- Steckdosen verbunden durch Verdrahtungsbrücken CM16
- mit Träger 4M ohne Schrauben
- zur Befestigung verwenden Sie Schrauben CM17, CM18 oder CM19
- Schraubklemmen 1,5-2,5 mm²
- entspricht IEC 60884-1, CEE7

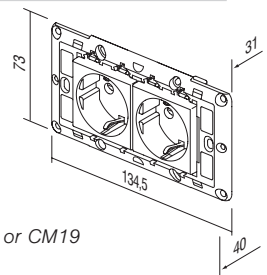

SOCKETS SET 2x SCHUKO 2P+E 16A 250V~ 4M

- socket set 2x schuko VM10 2P+E 16A 250V~
- prewired with link wires CM16
- with mounting frame 4M without screws
- for mounting frame fixing use screws CM17, CM18 or CM19
- screw contacts 1.5-2.5 mm²
- in accordance with IEC-60884-1, CEE7

SET STECKDOSEN 3x SCHUKO 2P+E 16A 250V~ 7M

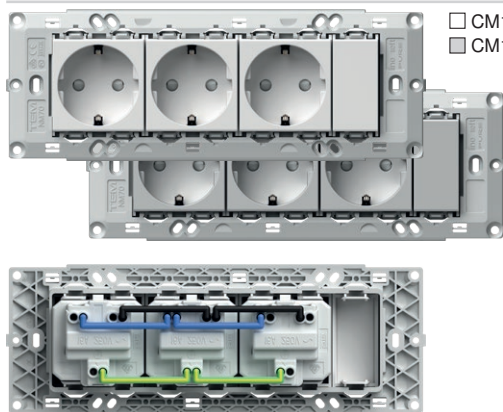

- CM11PW
- CM11ES

- Steckdosen-Set 3x Schuko VM10 2P+E 16A 250V~
- Steckdosen verbunden durch Verdrahtungsbrücken CM16
- mit Träger 7M ohne Schrauben
- zur Befestigung verwenden Sie Schrauben CM17, CM18 oder CM19
- Schraubklemmen 1,5-2,5 mm²
- entspricht IEC 60884-1, CEE7

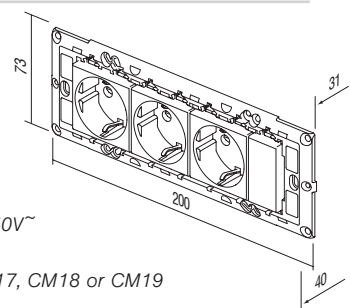

SOCKETS SET 3x SCHUKO 2P+E 16A 250V~ 7M

- socket set 3x schuko VM10 2P+E 16A 250V~
- prewired with link wires CM16
- with mounting frame 7M without screws
- for mounting frame fixing use screws CM17, CM18 or CM19
- screw contacts 1.5-2.5 mm²
- in accordance with IEC-60884-1, CEE7

SET VERDRÄHTUNGSBRÜCKEN FARBIG 3x1,5 mm² 1M



CM15

- Verdrahtungsbrücken-Set für Verbindung zweier Elemente mit Breite 1M
- Inkl. 10 schwarze, 10 blaue und 10 gelb-grüne Verdrahtungsbrücken

LINK WIRE SET 3x1.5mm² 1M

- link wire set to connect two elements size 1M
- includes 10 black, 10 blue and 10 yellow/green wires

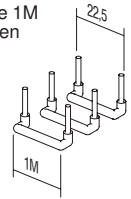

SET VERDRÄHTUNGSBRÜCKEN FARBIG 3x2,5 mm² 2M

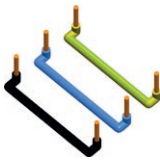

CM16

- Verdrahtungsbrücken-Set für Verbindung zweier Elemente mit Breite 2M
- Inkl. 10 schwarze, 10 blaue und 10 gelb-grüne Verdrahtungsbrücken

LINK WIRE SET 3x2.5mm² 2M

- link wire set to connect two elements size 2M
- includes 10 black, 10 blue and 10 yellow/green wires

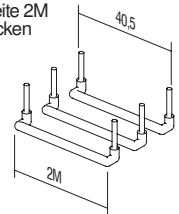

SCHRAUBEN-SET 3,5

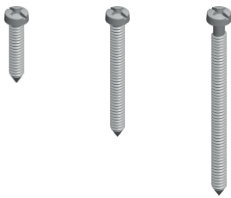

CM17
CM18
CM19

- Set mit Befestigungsschrauben für Montageträger NM30, NM32, NM40, NM41, NM70
- CM17 - l=20mm, 100 Stück
- CM18 - l=35mm, 50 Stück
- CM19 - l=50mm, 50 Stück

SCREW SET 3,5

- screw set for fixing mounting frames NM30, NM32, NM40, NM41, NM70
- CM17 - l=20mm, 100pcs
- CM18 - l=35mm, 50pcs
- CM19 - l=50mm, 50pcs

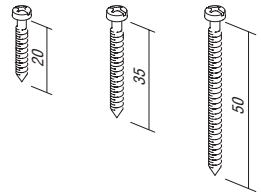

SCHALTER-SET IP44 2M



- CM22PW
- CM22SB
- CM22AT
- CM22ES
- CM22IW

- geeignet für feuchte Räume
- Schutzart IP44 für alle Schalter Modul
- Schalter und Wippen sind nicht im Set enthalten
- Rahmen SOFT 2M mit Namensschild
- entspricht IEC 60669-1

SET SWITCHES IP44 2M

- for usage in humid areas
- IP44 protection provides for all Modul switches
- switches and buttons are not part of the set
- SOFT 2M cover plate with inscription plate
- in accordance with IEC 60669-1



STECKDOSE-SET IP44 2M



- CM23PW
- CM23SB
- CM23AT
- CM23ES
- CM23IW

- geeignet für feuchte Räume
- Schutzart IP44 nur in Kombination mit Steckdose mit Klappdeckel (VM11, VM41)
- Steckdosen sind nicht im Set enthalten
- Rahmen SOFT 2M mit Namensschild
- entspricht IEC 60884-1

SET SOCKETS IP44 2M

- for usage in humid areas
- IP44 protection can be achieved only in combination with covered socket (VM11, VM41)
- sockets are not part of the set
- SOFT 2M cover plate with inscription plate
- in accordance with IEC 60884-1



BADEZIMMER-SET 3x20A 250V~ 4M

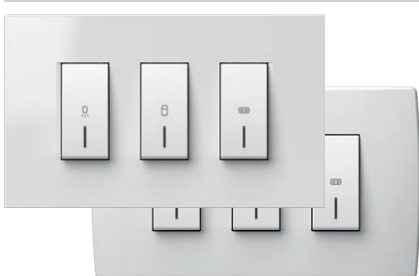

- CM25PWOL
- CM25IWOL
- CM25PWOS
- CM25IWOS

- Schalter-Set 3xSM12 20A 250V~ mit Montageträger und Rahmen
- Schraubklemmen 1,5-2,5mm²
- entspricht EN 60669-1
- Befestigungsmöglichkeit in bereits eingebaute Dosen mit Befestigungsmaßen von 108 bis 135 mm oder in Dosen in Größe 4M
- Höhe des Rahmens 90mm

SWITCH SET FOR BATHROOM 3x20A 250V~ 4M

- switch set 3xSM12 20A 250V~ with mounting frame and cover plate
- screw contacts 1.5-2.5mm²
- in accordance with EN 60669-1
- universal solution for renovation on boxes with fixing dimensions 108-135mm or boxes 4M size
- cover plate height 90mm

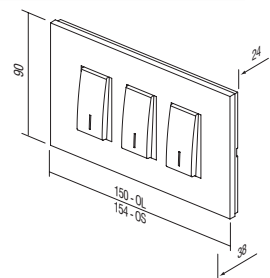



NM41

MONTAGETRÄGER FÜR BADEZIMMER-SET 4M

- Universal-Montageträger für Badezimmer-Set mit Schrauben
- Befestigungsmöglichkeit in bereits eingebaute Dosen mit Befestigungsmaßen von 108 bis 135 mm oder in Dosen in Größe 4M
- entspricht EN 60669-1

MOUNTING FRAME BATHROOM SET 4M

- universal mounting frame for bathroom set with screws
- universal solution for mounting on rectangular boxes with fixing dimensions 108-135mm or boxes 4M size
- in accordance with EN 60669-1

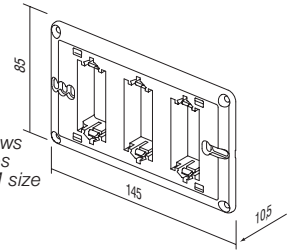

- | | |
|--|--------|
| | OL41PW |
| | OL41NB |
| | OL41IW |
| | OL41ES |
| | OL41SG |
| | OL41IB |
| | OL41AT |
| | OL41TI |
| | OL41SB |

RAHMEN LINE FÜR BADEZIMMER-SET

- dekorativer Rahmen LINE für Badezimmer-Set
- Höhe 90mm
- entspricht EN 60669-1

COVER PLATE LINE BATHROOM SET

- decorative cover plate bathroom set LINE
- height 90mm
- in accordance with EN 60669-1

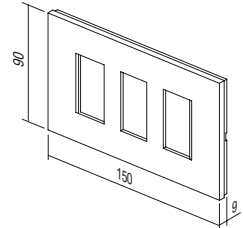

- | | | | |
|--|--------|--|--------|
| | OS41PW | | OS41SB |
| | OS41NB | | OS41WE |
| | OS41IW | | OS41AT |
| | OS41ES | | OS41TI |
| | OS41SG | | |

RAHMEN SOFT FÜR BADEZIMMER-SET

- dekorativer Rahmen SOFT für Badezimmer-Set
- Höhe 90mm
- entspricht EN 60669-1

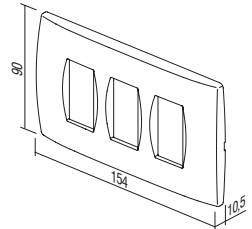

COVER PLATE SOFT BATHROOM SET

- decorative cover plate bathroom set SOFT
- height 90mm
- in accordance with EN 60669-1



ANTIBAKTERIENPROGRAMM MODUL

The diagram illustrates the components of the antibacterial program module. A hand is shown being washed under a faucet. Labels TM11, AW, and IN are placed above the hand, with lines pointing to the corresponding components in the table below. TM11 points to the switch button, AW points to the antibacterial white coating, and IN points to the indicator.

Typ type	Bezeichnung description	Größe size	Farbe colour	Optionsbezeichnung 1 optional data 1
TM11	WIPPE BUTTON	1M	<input type="checkbox"/> AW antibakterien weiß antibacterial white	 NT neutral neutral
TM21	BLENDE BLANK	1M		
VM10	STECKDOSE SOCKET	2M		 IN Indikator indicator
.	.	.		
.	.	.		

ANTIBAKTERIENPROGRAMM MODUL

- Schalter und Steckdosen werden tagtäglich den Kontakt von zahlreichen Menschen ausgesetzt und sind aufgrund dessen häufig Stellen zur Entwicklung und Verbreitung von Bakterien.
- Dank seiner antibakteriellen Eigenschaften ist Silber bereits seit 3 Jahrtausenden ein sicheres und effizientes Desinfektionsmittel, denn es ist vollkommen natürlich und Gesundheit- und umweltfreundlich.
- Ein besonderer antibakterieller Zusatz von Silberionen gewährleistet einen langfristigen, zuverlässigen und effizienten Schutz gegen die Entwicklung und Verbreitung von verschiedenen Bakterien, Mikroben und Pilzen.
- Antibakterienschutz bedeutet höhere Hygiene, Reinheit und Gesundheit für Menschen.
- Das Antibakterienprogramm Modul eignet sich zur Verwendung überall dort, wo strenge Hygienebedingungen herrschen (Krankenhäuser, Gesundheitszentren, pharmazeutische Einrichtungen, Pflegeheime, Laboratorien, Restaurants, Hotels, Flughafen, Bus- und Bahnstationen, Geschäfts- und Einkaufszentren, öffentliche Einrichtungen usw.).
- Die Labortests wurden in einer unabhängigen Institution nach höchsten japanischen Normen durchgeführt.
- Das Antibakterienprogramm Modul ermöglicht niedrige Kosten zur Gesunderhaltung.
- Die Form und Funktionalität des Antibakterienprogramms Modul ermöglichen einfache Reinigung und Wartung.
- Das Antibakterienprogramm Modul wird mit antibakteriellen Wippen, Rahmen und Steckdosen zusammen mit klassischen Montagetägern und Schaltern kombiniert.
- Jedes Produkt ist aufgrund der einfacheren Identifikation an der Rückseite durch AW (antibacterial white) gekennzeichnet.

ANTIBACTERIAL PROGRAM MODUL

- switches and sockets are daily touched by many people, so this is a common place for development and spread of bacteria
- thanks to its natural antibacterial characteristics silver has been used for three millennia as a safe and effective disinfectant, since it is completely natural, healthy and environmentally friendly
- special antibacterial silver ions additive provides long-term, reliable and effective protection against the development and spread of bacteria, microbes and fungi
- antibacterial protection ensures hygiene, cleanliness and health for people
- perfectly suitable for use in environments with strict hygiene conditions (hospitals, health centers, pharmaceutical facilities, homes for elderly, nursing homes, laboratories, restaurants, hotels, airports, bus and railway stations, business and shopping areas, public institutions ...)
- independent laboratory testings have been carried out in accordance with highest Japanese standards JIS Z 2801
- low cost for providing human health
- design and functionality of antibacterial program MODUL allow easy cleaning and maintenance
- antibacterial buttons, cover plates and sockets are combined with classic mounting frames and switches
- products are labelled on the back with AW (antibacterial white)

ANTIBACTERIAL PROGRAM MODUL

	□ TM11AW	WIPPE 1M - Wippe auswechselbar, Breite 1M - entspricht EN 60669-1 - Antibakterienschutz gemäß JIS Z 2801	
		BUTTON 1M - replaceable button 1M - in accordance with EN 60669-1 - antibacterial protection in accordance with JIS Z 2801	
	□ TM11AWIN	WIPPE MIT INDIKATOR 1M - Wippe auswechselbar, Breite 1M - entspricht EN 60669-1 - Antibakterienschutz gemäß JIS Z 2801	
		BUTTON 1M INDICATOR - replaceable button 1M - in accordance with EN 60669-1 - antibacterial protection in accordance with JIS Z 2801	
	□ TM12AW	WIPPE 2M - Wippe auswechselbar, Breite 2M mit Wippenträger - zur Erweiterung von Schaltern oder Tastern in Breite 1M auf Breite 2M - entspricht EN 60669-1 - Antibakterienschutz gemäß JIS Z 2801	
		BUTTON 2M - replaceable button 2M with button carrier - to upgrade switch or push button from size 1M to size 2M - in accordance with EN 60669-1 - antibacterial protection in accordance with JIS Z 2801	
	□ TM12AWIN	WIPPE MIT INDIKATOR 2M - Wippe auswechselbar, Breite 2M mit Wippenträger - zur Erweiterung von Schaltern oder Tastern in Breite 1M auf Breite 2M - entspricht EN 60669-1 - Antibakterienschutz gemäß JIS Z 2801	
		BUTTON 2M INDICATOR - replaceable button 2M with button carrier - to upgrade switch or push button from size 1M to size 2M - in accordance with EN 60669-1 - antibacterial protection in accordance with JIS Z 2801	
	□ TM21AW	BLENDE 1M - zur Ausfüllung von leeren Stellen - entspricht EN 60669-1 - Antibakterienschutz gemäß JIS Z 2801	
		BLANK 1M - blank modul to fill up empty spaces - in accordance with EN 60669-1 - antibacterial protection in accordance with JIS Z 2801	
	□ TM22AW	BLENDE 2M - zur Ausfüllung von leeren Stellen - entspricht EN 60669-1 - Antibakterienschutz gemäß JIS Z 2801	
		BLANK 2M - blank modul to fill up empty spaces - in accordance with EN 60669-1 - antibacterial protection in accordance with JIS Z 2801	



□ VM10AW

STECKDOSE SCHUKO+KS 2P+E 16A 250V~ 2M

- Steckdose mit Schutzkontakt
- 16A 250V~, Typ VM10
- entspricht IEC 60884-1, CEE7
- Schraubklemmen 1,5–2,5 mm²
- Steckdose mit erhöhtem Berührungsschutz
- Antibakterienschutz gemäß JIS Z 2801

SOCKET SCHUKO+KS 2P+E 16A 250V~ 2M

- 2P+E schuko
- 16A 250V~, type VM10
- in accordance with IEC 60884-1, CEE7
- screw contacts 1.5-2.5 mm²
- shuttered live contacts
- antibacterial protection in accordance with JIS Z 2801



□ VM11AW

STECKDOSE SCHUKO+KS+KLAPPDECKEL 2P+E 16A 250V~ 2M

- Steckdose mit Schutzkontakt mit Klappdeckel
- 16A 250V~, Typ VM11
- entspricht IEC 60884-1, CEE7
- Schraubklemmen 1,5–2,5 mm²
- Steckdose mit erhöhtem Berührungsschutz
- Antibakterienschutz gemäß JIS Z 2801

SOCKET SCHUKO+KS+COVER

- 2P+E schuko+cover
- 16A 250V~, type VM11
- in accordance with IEC 60884-1, CEE7
- screw contacts 1.5-2.5 mm²
- shuttered live contacts
- antibacterial protection in accordance with JIS Z 2801



□ VM20AW

STECKDOSE EURO+KS 2P 10A 250V~ 1M

- 2P Eurosteckdose
- 10A 250V~, Typ VM20
- entspricht IEC 60884-1, CEE7
- Schraubklemmen 1,5–2,5 mm²
- Steckdose mit erhöhtem Berührungsschutz
- Antibakterienschutz gemäß JIS Z 2801

SOCKET EURO+KS 2P 10A 250V~ 1M

- 2P Euro
- 10A 250V~, type VM20
- in accordance with IEC 60884-1, CEE7
- screw contacts 1.5-2.5 mm²
- shuttered live contacts
- antibacterial protection in accordance with JIS Z 2801



□ KM11AW

TV-ENDDOSE 1dB 1M

- TV-Enddose
- Übertragungsbandbreite 5÷2400 MHz
- Dämpfung < 1 dB
- entspricht EN 50083-1
- Schraubklemmen
- Antibakterienschutz gemäß JIS Z 2801

SOCKET TV END-LINE 1dB 1M

- TV end-line
- frequency range 5÷2400 MHz
- reduction < 1 dB
- in accordance with EN 50083-1
- screw contacts
- antibacterial protection in accordance with JIS Z 2801

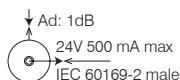

□ KM35AW

ADAPTER KS 1M

- KS – keystone-Befestigungsstandard
- AMP, Avaya, Brandrex, FMT, Mfico, Tyco, ...
- ohne Kommunikationsmodul
- Antibakterienschutz gemäß JIS Z 2801

ADAPTER KS 1M

- KS keystone fixing standard
- AMP, Avaya, Brandrex, FMT, Mfico, Tyco, ...
- communication module not included
- antibacterial protection in accordance with JIS Z 2801





OS20AW

RAHMEN SOFT 2M

- dekorativer Rahmen SOFT 2M
- entspricht EN 60669-1
- Antibakterienschutz gemäß JIS Z 2801

COVER PLATE SOFT 2M

- decorative cover plate SOFT 2M
- in accordance with EN 60669-1
- antibacterial protection in accordance with JIS Z 2801



OS24AW

RAHMEN SOFT 2x2M

- dekorativer Rahmen SOFT 2x2M
- Horizontal- oder Vertikalmontage
- entspricht EN 60669-1
- Antibakterienschutz gemäß JIS Z 2801

COVER PLATE SOFT 2x2M

- decorative cover plate SOFT 2x2M
- horizontal or vertical mounting
- in accordance with EN 60669-1
- antibacterial protection in accordance with JIS Z 2801



OS26AW

RAHMEN SOFT 3x2M

- dekorativer Rahmen SOFT 3x2M
- Horizontal- oder Vertikalmontage
- entspricht EN 60669-1
- Antibakterienschutz gemäß JIS Z 2801

COVER PLATE SOFT 3x2M

- decorative cover plate SOFT 3x2M
- horizontal or vertical mounting
- in accordance with EN 60669-1
- antibacterial protection in accordance with JIS Z 2801



OS30AW

RAHMEN SOFT 3M

- dekorativer Rahmen SOFT 3M
- entspricht EN 60669-1
- Antibakterienschutz gemäß JIS Z 2801

COVER PLATE SOFT 3M

- decorative cover plate SOFT 3M
- in accordance with EN 60669-1
- antibacterial protection in accordance with JIS Z 2801



OS40AW

RAHMEN SOFT 4M

- dekorativer Rahmen SOFT 4M
- entspricht EN 60669-1
- Antibakterienschutz gemäß JIS Z 2801

COVER PLATE SOFT 4M

- decorative cover plate SOFT 4M
- in accordance with EN 60669-1
- antibacterial protection in accordance with JIS Z 2801

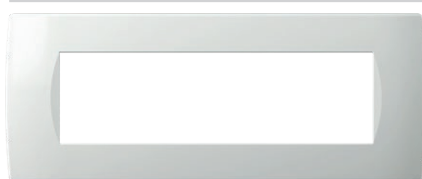

OS70AW

RAHMEN SOFT 7M

- dekorativer Rahmen SOFT 7M
- entspricht EN 60669-1
- Antibakterienschutz gemäß JIS Z 2801

COVER PLATE SOFT 7M

- decorative cover plate SOFT 7M
- in accordance with EN 60669-1
- antibacterial protection in accordance with JIS Z 2801

Holz
wood

WB Bambus
bamboo



WW Nuss
walnut

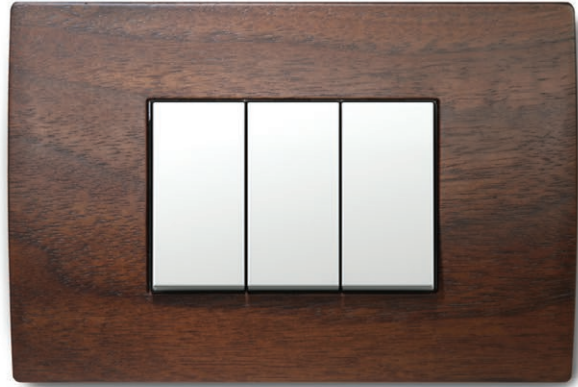

WM Ahorn
maple



WE Wenge
wenge

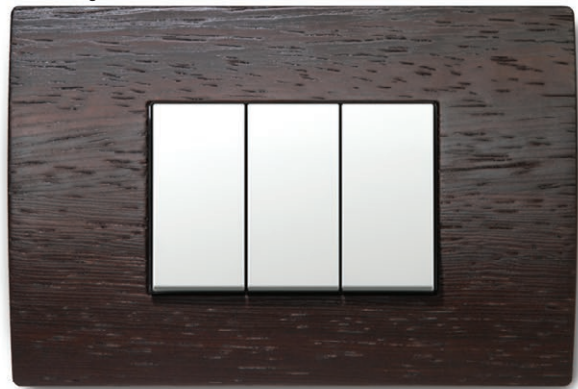

Die Natur ist einzigartig und wertvoll, so wie unsere Rahmen, unter denen es keine zwei gleiche gibt.

Wir können bei den Holzrahmen keine Beanstandungen wegen der Unterschiede im Aussehen und Unterscheidung untereinander berücksichtigen berücksichtigen.

Nature is unique and precious, as our decorative cover plates where no two are the same.

Complaints about wooden decorative cover plate's diverse appearance and differentiation cannot be considered.

COVER PLATES PURE OP

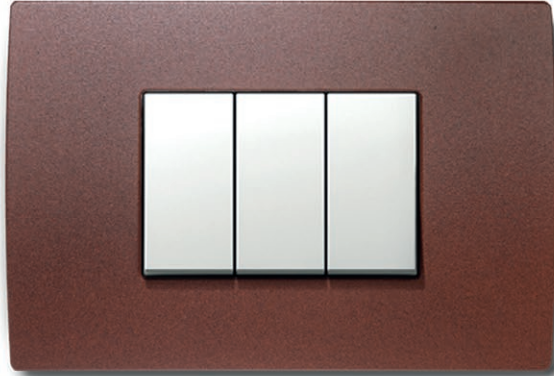
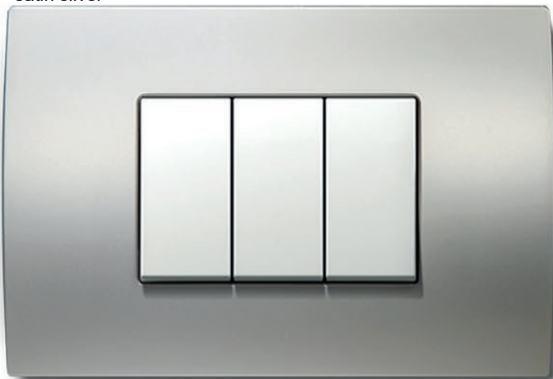
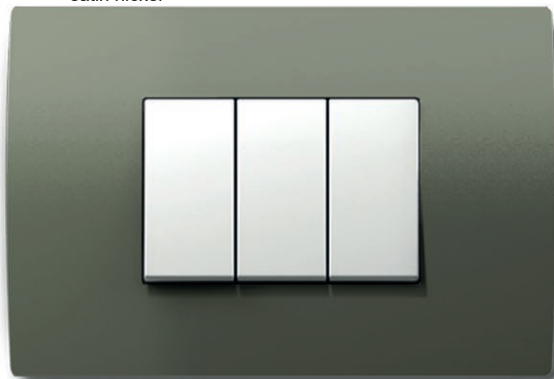
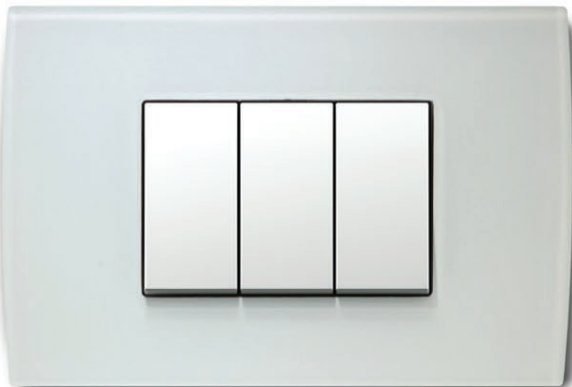
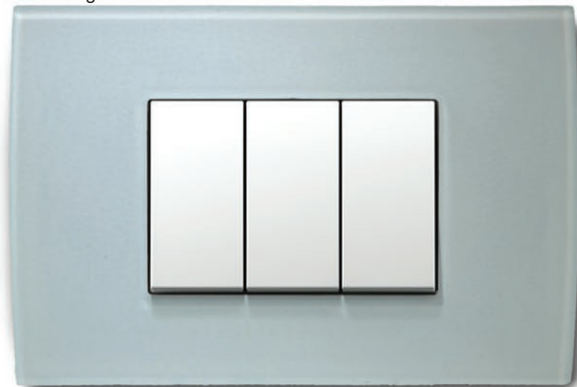
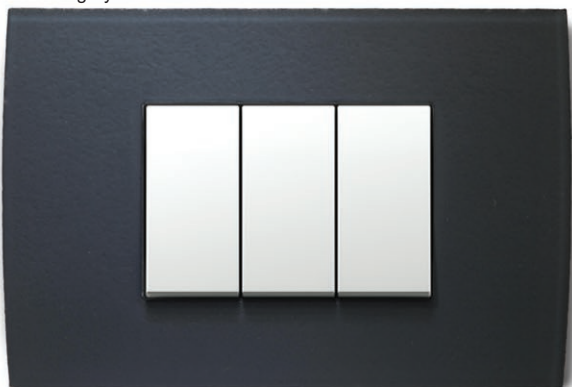
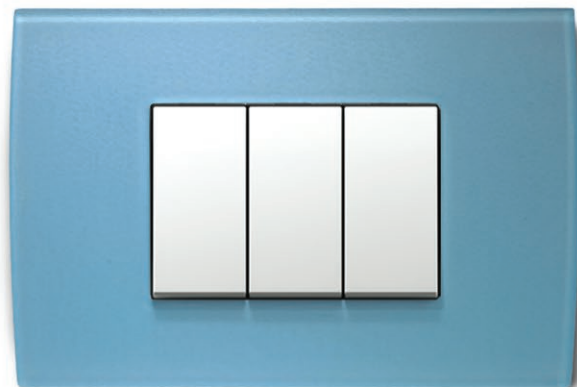
Metall
metalMH geschmiedeter Stahl
hammered steelME geätztes Eisen
etched ironMS Satinsilber
satin silverMN satin Nickel
satin nickelGlas
glassGW eisweiß
ice whiteGG eisgrün
ice greenGY eisgrau
ice greyGB eisblau
ice blue



OP30

WB

Typ type	Bezeichnung description	Größe size	Farbe colour
OP13	RAHMEN PURE COVER PLATE PURE	1/3M	MH geschmiedeter Stahl hammered steel WB Bambus bamboo GW eisweiß ice white
OP20	RAHMEN PURE COVER PLATE PURE	2M	ME geätztes Eisen etched iron WW Nuss walnut GG eisgrün ice green
OP23	RAHMEN PURE COVER PLATE PURE	2/3M	MS Satinsilber satin silver WM Ahorn maple GY eisgrau ice grey
.	.	.	MN satin Nickel satin nickel WE Wenge wenge GB eisblau ice blue



MH	OP20MH	WB	OP20WB
ME	OP20ME	WW	OP20WW
MS	OP20MS	WM	OP20WM
MN	OP20MN	WE	OP20WE
		GW	OP20GW
		GG	OP20GG
		GY	OP20GY
		GB	OP20GB

RAHMEN PURE 2M

- dekorativer Rahmen PURE 2M
- entspricht EN 60669-1
- nur in Verbindung mit Montageträger NM24 oder NM25

COVER PLATE PURE 2M

- decorative cover plate PURE 2M
- in accordance with EN 60669-1
- only in combination with mounting frame NM24 or NM25

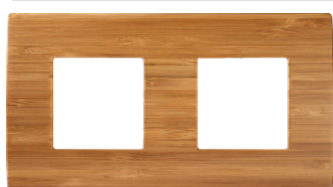

MH	OP24MH	WB	OP24WB
ME	OP24ME	WW	OP24WW
MS	OP24MS	WM	OP24WM
MN	OP24MN	WE	OP24WE
		GW	OP24GW
		GG	OP24GG
		GY	OP24GY
		GB	OP24GB

RAHMEN PURE 2x2M

- dekorativer Rahmen PURE 2x2M
- Horizontal- oder Vertikalmontage
- entspricht EN 60669-1
- nur in Verbindung mit Montageträger NM24 oder NM25

COVER PLATE PURE 2x2M

- decorative cover plate PURE 2x2M
- horizontal or vertical mounting
- in accordance with EN 60669-1
- only in combination with mounting frames NM24 or NM25



MH	OP26MH	WB	OP26WB
ME	OP26ME	WW	OP26WW
MS	OP26MS	WM	OP26WM
MN	OP26MN	WE	OP26WE
		GW	OP26GW
		GG	OP26GG
		GY	OP26GY
		GB	OP26GB

RAHMEN PURE 3x2M

- dekorativer Rahmen PURE 3x2M
- Horizontal- oder Vertikalmontage
- entspricht EN 60669-1
- nur in Verbindung mit Montageträger NM24 oder NM25

COVER PLATE PURE 3x2M

- decorative cover plate PURE 3x2M
- horizontal or vertical mounting
- in accordance with EN 60669-1
- only in combination with mounting frames NM24 or NM25



MH	OP28MH	WB	OP28WB
ME	OP28ME	WW	OP28WW
MS	OP28MS	WM	OP28WM
MN	OP28MN	WE	OP28WE
		GW	OP28GW
		GG	OP28GG
		GY	OP28GY
		GB	OP28GB

RAHMEN PURE 4x2M

- dekorativer Rahmen PURE 4x2M
- Horizontal- oder Vertikalmontage
- entspricht EN 60669-1
- nur in Verbindung mit Montageträger NM24 oder NM25

COVER PLATE PURE 4x2M

- decorative cover plate PURE 4x2M
- horizontal or vertical mounting
- in accordance with EN 60669-1
- only in combination with mounting frames NM24 or NM25

C O V E R P L A T E S P U R E O P



	OP30MH		OP30WB
	OP30ME		OP30WW
	OP30MS		OP30WM
	OP30MN		OP30WE
			OP30GW
			OP30GG
			OP30GY
			OP30GB

RAHMEN PURE 3M

- dekorativer Rahmen PURE 3M
- entspricht EN 60669-1

COVER PLATE PURE 3M

- decorative cover plate PURE 3M
- in accordance with EN 60669-1



	OP40MH		OP40WB
	OP40ME		OP40WW
	OP40MS		OP40WM
	OP40MN		OP40WE
			OP40GW
			OP40GG
			OP40GY
			OP40GB

RAHMEN PURE 4M

- dekorativer Rahmen PURE 4M
- entspricht EN 60669-1

COVER PLATE PURE 4M

- decorative cover plate PURE 4M
- in accordance with EN 60669-1



	OP70MH		OP70WB
	OP70ME		OP70WW
	OP70MS		OP70WM
	OP70MN		OP70WE
			OP70GW
			OP70GG
			OP70GY
			OP70GB

RAHMEN PURE 7M

- dekorativer Rahmen PURE 7M
- entspricht EN 60669-1

COVER PLATE PURE 7M

- decorative cover plate PURE 7M
- in accordance with EN 60669-1



	OP13MH		OP13WB
	OP13ME		OP13WW
	OP13MS		OP13WM
	OP13MN		OP13WE
			OP13GW
			OP13GG
			OP13GY
			OP13GB

RAHMEN PURE 1/3M

- dekorativer Rahmen PURE 1/3M
- entspricht EN 60669-1

COVER PLATE PURE 1/3M

- decorative cover plate PURE 1/3M
- in accordance with EN 60669-1



	OP23MH		OP23WB
	OP23ME		OP23WW
	OP23MS		OP23WM
	OP23MN		OP23WE
			OP23GW
			OP23GG
			OP23GY
			OP23GB

RAHMEN PURE 2/3M

- dekorativer Rahmen PURE 2/3M
- entspricht EN 60669-1

COVER PLATE PURE 2/3M

- decorative cover plate PURE 2/3M
- in accordance with EN 60669-1

basic
basic

PW weiß-glänzend
polar white

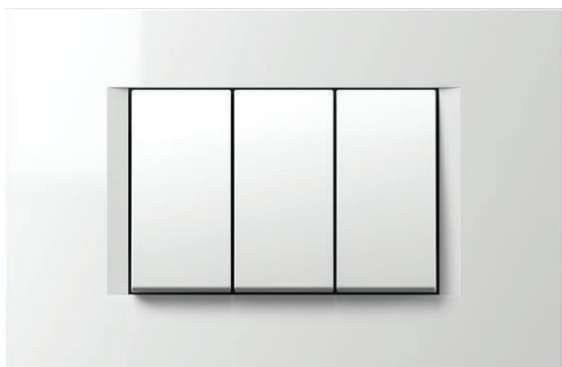

IW beige-glänzend
ivory white

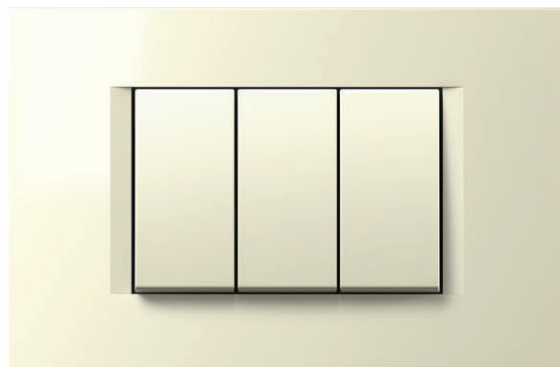

ES silber-matt
elox silver



SB schwarz-matt
soft touch black

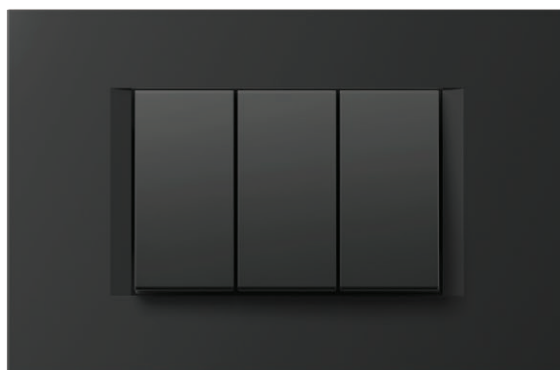

AT anthrazit
anthracite



COVER PLATES LINE OL

dekor
decor

SG sandgold
sand gold

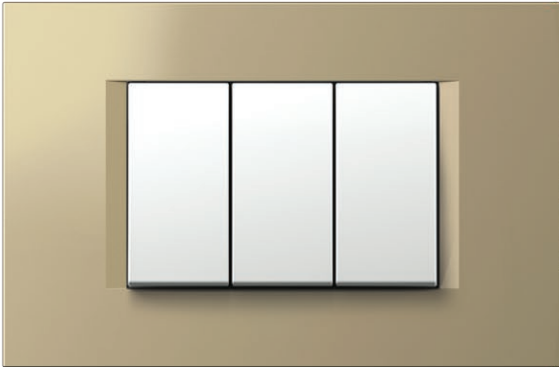

NB schwarz-glänzend
night black

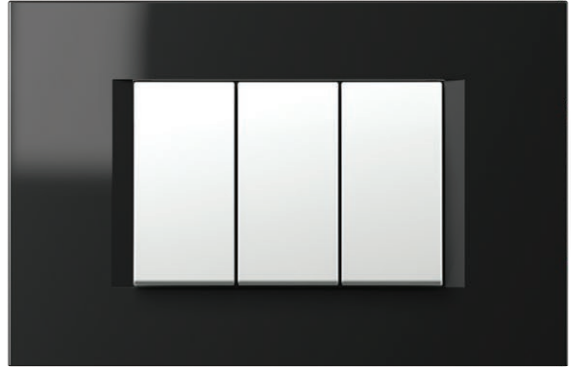

IB blau-matt
impulse blue

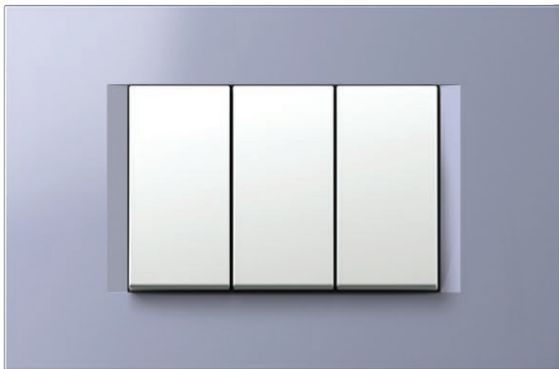

TI titan
titanium



SW steinweiß
stone white



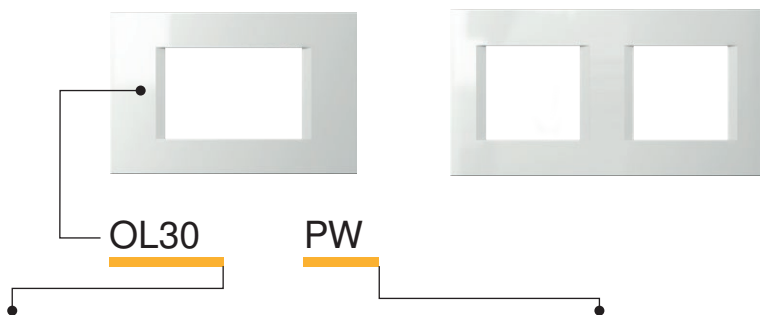

Typ type	Bezeichnung description	Größe size	Farbe colour												
OL10	RAHMEN LINE COVER PLATE LINE	1/2M	<table border="0"> <tr> <td></td> <td>PW weiß-glänzend polar white</td> <td></td> <td>SG gold-matt sand gold</td> <td></td> <td>AT anthrazit anthracite</td> </tr> </table>		PW weiß-glänzend polar white		SG gold-matt sand gold		AT anthrazit anthracite						
	PW weiß-glänzend polar white		SG gold-matt sand gold		AT anthrazit anthracite										
OL13	RAHMEN LINE COVER PLATE LINE	1/3M	<table border="0"> <tr> <td></td> <td>IW beige-glänzend ivory white</td> <td></td> <td>NB schwarz-glänzend night black</td> <td></td> <td>TI titan titanium</td> </tr> </table>		IW beige-glänzend ivory white		NB schwarz-glänzend night black		TI titan titanium						
	IW beige-glänzend ivory white		NB schwarz-glänzend night black		TI titan titanium										
OL20	RAHMEN LINE COVER PLATE LINE	2M	<table border="0"> <tr> <td></td> <td>ES silber-matt elox silver</td> <td></td> <td>IB blau-matt impulse blue</td> <td></td> <td>SW steinweiß stone white</td> </tr> <tr> <td></td> <td>SB schwarz-matt soft touch black</td> <td></td> <td></td> <td></td> <td></td> </tr> </table>		ES silber-matt elox silver		IB blau-matt impulse blue		SW steinweiß stone white		SB schwarz-matt soft touch black				
	ES silber-matt elox silver		IB blau-matt impulse blue		SW steinweiß stone white										
	SB schwarz-matt soft touch black														
.	.	.	.												
.	.	.	.												



RAHMEN LINE 2M



	OL20PW		OL20SG
	OL20IW		OL20NB
	OL20ES		OL20IB
	OL20SB		OL20AT
			OL20TI
			OL20SW

- dekorativer Rahmen LINE 2M
- entspricht EN 60669-1

COVER PLATE LINE 2M

- decorative cover plate LINE 2M
- in accordance with EN 60669-1

RAHMEN LINE 2x2M

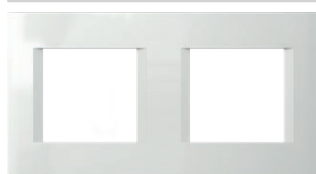

	OL24PW		OL24SG
	OL24IW		OL24NB
	OL24ES		OL24IB
	OL24SB		OL24AT
			OL24TI
			OL24SW

- dekorativer Rahmen LINE 2x2M
- Horizontal- oder Vertikalmontage
- entspricht EN 60669-1

COVER PLATE LINE 2x2M

- decorative cover plate LINE 2x2M
- horizontal or vertical mounting
- in accordance with EN 60669-1

RAHMEN LINE 3x2M

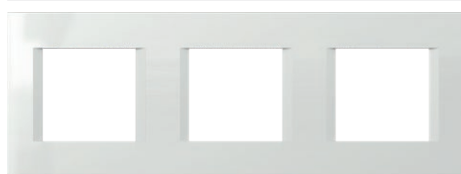

	OL26PW		OL26SG
	OL26IW		OL26NB
	OL26ES		OL26IB
	OL26SB		OL26AT
			OL26TI
			OL26SW

- dekorativer Rahmen LINE 3x2M
- Horizontal- oder Vertikalmontage
- entspricht EN 60669-1

COVER PLATE LINE 3x2M

- decorative cover plate LINE 3x2M
- horizontal or vertical mounting
- in accordance with EN 60669-1

RAHMEN LINE 4x2M



	OL28PW		OL28SG
	OL28IW		OL28NB
	OL28ES		OL28IB
	OL28SB		OL28AT
			OL28TI
			OL28SW

- dekorativer Rahmen LINE 4x2M
- Horizontal- oder Vertikalmontage
- entspricht EN 60669-1

COVER PLATE LINE 4x2M

- decorative cover plate LINE 4x2M
- horizontal or vertical mounting
- in accordance with EN 60669-1

RAHMEN LINE 5x2M

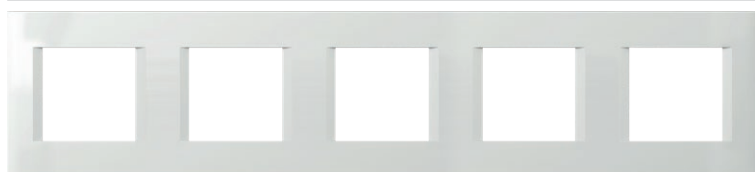

	OL29PW
	OL29IW
	OL29ES
	OL29SB
	OL29AT
	OL29TI

- dekorativer Rahmen LINE 5x2M
- Horizontal- oder Vertikalmontage
- entspricht EN 60669-1

COVER PLATE LINE 5x2M

- decorative cover plate LINE 5x2M
- horizontal or vertical mounting
- in accordance with EN 60669-1

C O V E R P L A T E S L I N E O L

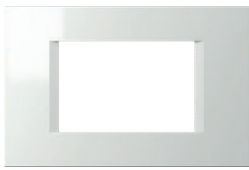

- | | |
|--|--|
|  OL30PW |  OL30SG |
|  OL30IW |  OL30NB |
|  OL30ES |  OL30IB |
|  OL30SB |  OL30AT |
| |  OL30TI |
| |  OL30SW |











RAHMEN LINE 3M

- dekorativer Rahmen LINE 3M
- entspricht EN 60669-1

COVER PLATE LINE 3M

- decorative cover plate LINE 3M
- in accordance with EN 60669-1



- | | |
|--|--|
|  OL40PW |  OL40SG |
|  OL40IW |  OL40NB |
|  OL40ES |  OL40IB |
|  OL40SB |  OL40AT |
| |  OL40TI |
| |  OL40SW |

RAHMEN LINE 4M

- dekorativer Rahmen LINE 4M
- entspricht EN 60669-1

COVER PLATE LINE 4M

- decorative cover plate LINE 4M
- in accordance with EN 60669-1



- | | |
|--|--|
|  OL70PW |  OL70SG |
|  OL70IW |  OL70NB |
|  OL70ES |  OL70IB |
|  OL70SB |  OL70AT |
| |  OL70TI |
| |  OL70SW |









RAHMEN LINE 7M

- dekorativer Rahmen LINE 7M
- entspricht EN 60669-1

COVER PLATE LINE 7M

- decorative cover plate LINE 7M
- in accordance with EN 60669-1



- | | |
|--|--|
|  OL10PW |  OL10SG |
|  OL10IW |  OL10NB |
|  OL10ES |  OL10IB |
|  OL10SB |  OL10AT |
| |  OL10TI |
| |  OL10SW |







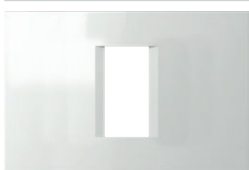

RAHMEN LINE 1/2M

- dekorativer Rahmen LINE 1/2M
- entspricht EN 60669-1

COVER PLATE LINE 1/2M

- decorative cover plate LINE 1/2M
- in accordance with EN 60669-1



- | | |
|--|--|
|  OL13PW |  OL13SG |
|  OL13IW |  OL13NB |
|  OL13ES |  OL13IB |
|  OL13SB |  OL13AT |
| |  OL13TI |
| |  OL13SW |











RAHMEN LINE 1/3M

- dekorativer Rahmen LINE 1/3M
- entspricht EN 60669-1

COVER PLATE LINE 1/3M

- decorative cover plate LINE 1/3M
- in accordance with EN 60669-1



- | | |
|--|--|
|  OL23PW |  OL23SG |
|  OL23IW |  OL23NB |
|  OL23ES |  OL23IB |
|  OL23SB |  OL23AT |
| |  OL23TI |
| |  OL23SW |

RAHMEN LINE 2/3M

- dekorativer Rahmen LINE 2/3M
- entspricht EN 60669-1

COVER PLATE LINE 2/3M

- decorative cover plate LINE 2/3M
- in accordance with EN 60669-1

basic
basic

PW weiß-glänzend
polar white

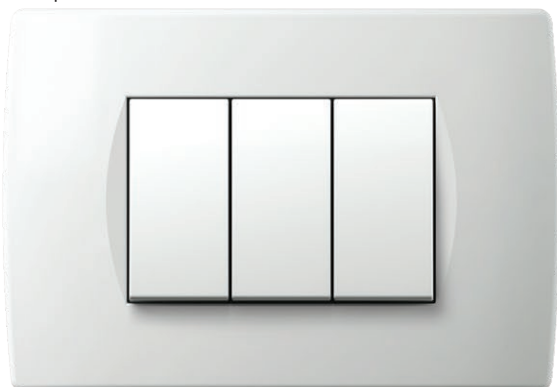

IW beige-glänzend
ivory white

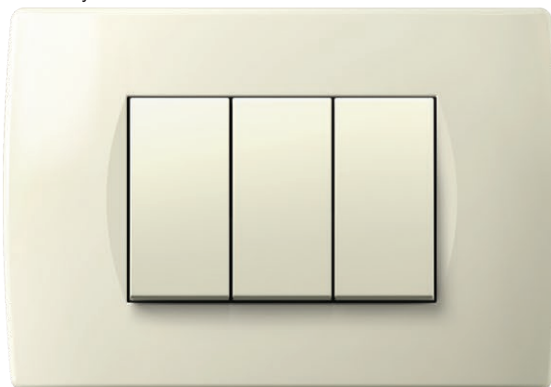

ES silber-matt
elox silver

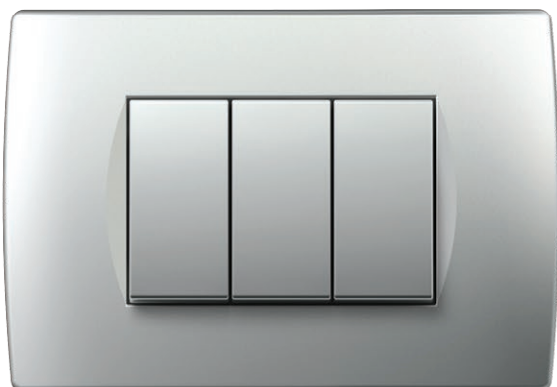

SB schwarz-matt
soft touch black

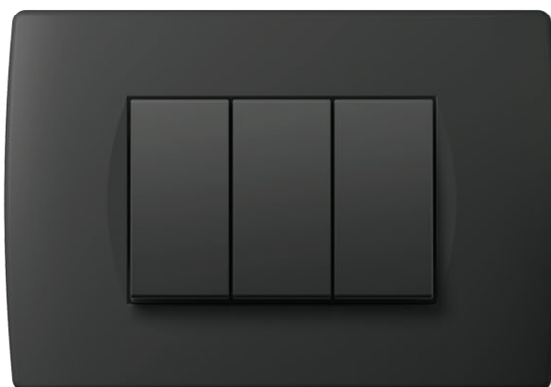

AT anthrazit
anthracite

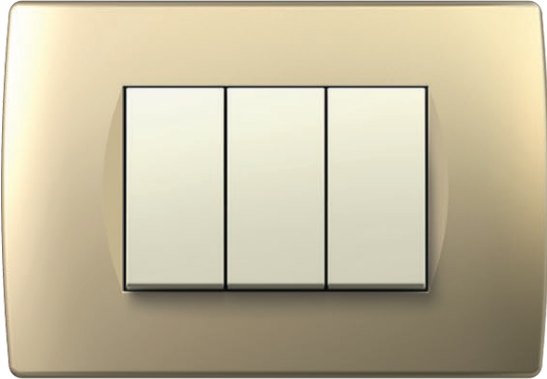
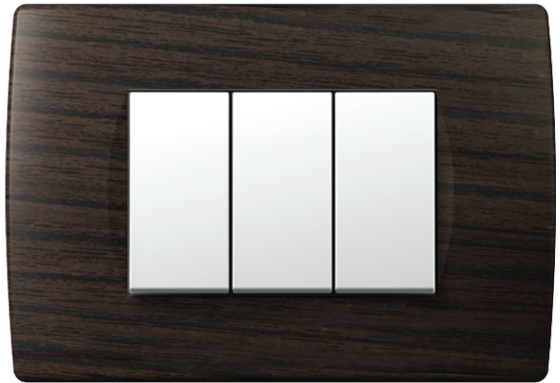

COVER PLATES SOFT OS

dekor
decorSG sandgold
sand goldNB schwarz-glänzend
night blackTI titan
titaniumWE Wenge
wengeWW Nuss
walnut

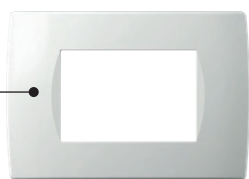

OS30

PW

Typ type	Bezeichnung description	Größe size	Farbe colour												
OS10	RAHMEN SOFT COVER PLATE SOFT	1/2M	<table border="0"> <tr> <td></td> <td>PW weiß-glänzend polar white</td> <td></td> <td>SG sandgold sand gold</td> <td></td> <td>WW Nuss walnut</td> </tr> </table>		PW weiß-glänzend polar white		SG sandgold sand gold		WW Nuss walnut						
	PW weiß-glänzend polar white		SG sandgold sand gold		WW Nuss walnut										
OS13	RAHMEN SOFT COVER PLATE SOFT	1/3M	<table border="0"> <tr> <td></td> <td>IW beige-glänzend ivory white</td> <td></td> <td>NB sch.-glänzend night black</td> <td></td> <td>WE Wenge wenge</td> </tr> </table>		IW beige-glänzend ivory white		NB sch.-glänzend night black		WE Wenge wenge						
	IW beige-glänzend ivory white		NB sch.-glänzend night black		WE Wenge wenge										
OS20	RAHMEN SOFT COVER PLATE SOFT	2M	<table border="0"> <tr> <td></td> <td>ES silber-matt elox silver</td> <td></td> <td>AT anthrazit anthracite</td> <td></td> <td></td> </tr> <tr> <td></td> <td>SB schwarz-matt soft touch black</td> <td></td> <td>TI titan titanium</td> <td></td> <td></td> </tr> </table>		ES silber-matt elox silver		AT anthrazit anthracite				SB schwarz-matt soft touch black		TI titan titanium		
	ES silber-matt elox silver		AT anthrazit anthracite												
	SB schwarz-matt soft touch black		TI titan titanium												
.	.	.	.												
.	.	.	.												



	OS20PW		OS20SG
	OS20IW		OS20NB
	OS20ES		OS20AT
	OS20SB		OS20TI
			OS20WW
			OS20WE

RAHMEN SOFT 2M

- dekorativer Rahmen SOFT 2M
- entspricht EN 60669-1

COVER PLATE SOFT 2M

- decorative cover plate SOFT 2M
- in accordance with EN 60669-1



	OS24PW		OS24SG
	OS24IW		OS24NB
	OS24ES		OS24AT
	OS24SB		OS24TI
			OS24WW
			OS24WE

RAHMEN SOFT 2x2M

- dekorativer Rahmen SOFT 2x2M
- Horizontal- oder Vertikalmontage
- entspricht EN 60669-1

COVER PLATE SOFT 2x2M

- decorative cover plate SOFT 2x2M
- horizontal or vertical mounting
- in accordance with EN 60669-1

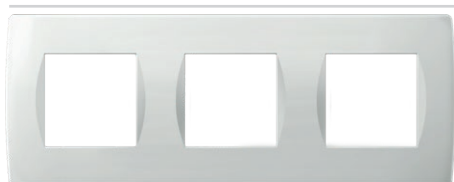

	OS26PW		OS26SG
	OS26IW		OS26NB
	OS26ES		OS26AT
	OS26SB		OS26TI
			OS26WW
			OS26WE

RAHMEN SOFT 3x2M

- dekorativer Rahmen SOFT 3x2M
- Horizontal- oder Vertikalmontage
- entspricht EN 60669-1

COVER PLATE SOFT 3x2M

- decorative cover plate SOFT 3x2M
- horizontal or vertical mounting
- in accordance with EN 60669-1



	OS28PW		OS28SG
	OS28IW		OS28NB
	OS28ES		OS28AT
	OS28SB		OS28TI
			OS28WW
			OS28WE

RAHMEN SOFT 4x2M

- dekorativer Rahmen SOFT 4x2M
- Horizontal- oder Vertikalmontage
- entspricht EN 60669-1

COVER PLATE SOFT 4x2M

- decorative cover plate SOFT 4x2M
- horizontal or vertical mounting
- in accordance with EN 60669-1

MODUL

SOFT

C O V E R P L A T E S S O F T O S



 OS30PW	 OS30SG
 OS30IW	 OS30NB
 OS30ES	 OS30AT
 OS30SB	 OS30TI
	 OS30WW
	 OS30WE

RAHMEN SOFT 3M

- dekorativer Rahmen SOFT 3M
- entspricht EN 60669-1

COVER PLATE SOFT 3M

- decorative cover plate SOFT 3M
- in accordance with EN 60669-1



 OS40PW	 OS40SG
 OS40IW	 OS40NB
 OS40ES	 OS40AT
 OS40SB	 OS40TI
	 OS40WW
	 OS40WE



RAHMEN SOFT 4M

- dekorativer Rahmen SOFT 4M
- entspricht EN 60669-1

COVER PLATE SOFT 4M

- decorative cover plate SOFT 4M
- in accordance with EN 60669-1



 OS70PW	 OS70SG
 OS70IW	 OS70NB
 OS70ES	 OS70AT
 OS70SB	 OS70TI
	 OS70WW
	 OS70WE



RAHMEN SOFT 7M

- dekorativer Rahmen SOFT 7M
- entspricht EN 60669-1

COVER PLATE SOFT 7M

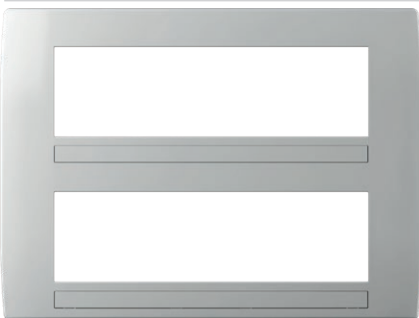
- decorative cover plate SOFT 7M
- in accordance with EN 60669-1



 OS72PW	 OS72AT
 OS72IW	 OS72TI
 OS72ES	
 OS72SB	



RAHMEN SOFT 2x7M

- dekorativer Rahmen SOFT 2x7M
mit Namensschild
- entspricht EN 60669-1

COVER PLATE SOFT 2x7M

- decorative cover plate SOFT 2x7M
with inscription plate
- in accordance with EN 60669-1



 OS10PW	 OS10SG
 OS10IW	 OS10NB
 OS10ES	 OS10AT
 OS10SB	 OS10TI
	 OS10WW
	 OS10WE









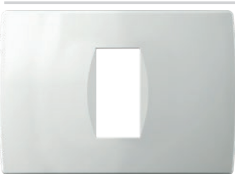

RAHMEN SOFT 1/2M

- dekorativer Rahmen SOFT 1/2M
- entspricht EN 60669-1

COVER PLATE SOFT 1/2M

- decorative cover plate SOFT 1/2M
- in accordance with EN 60669-1



 OS13PW	 OS13SG
 OS13IW	 OS13NB
 OS13ES	 OS13AT
 OS13SB	 OS13TI
	 OS13WW
	 OS13WE

RAHMEN SOFT 1/3M

- dekorativer Rahmen SOFT 1/3M
- entspricht EN 60669-1

COVER PLATE SOFT 1/3M

- decorative cover plate SOFT 1/3M
- in accordance with EN 60669-1

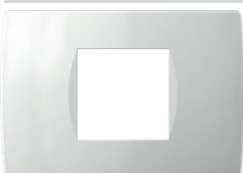

 OS23PW	 OS23SG
 OS23IW	 OS23NB
 OS23ES	 OS23AT
 OS23SB	 OS23TI
	 OS23WW
	 OS23WE

RAHMEN SOFT 2/3M

- dekorativer Rahmen SOFT 2/3M
- entspricht EN 60669-1

COVER PLATE SOFT 2/3M

- decorative cover plate SOFT 2/3M
- in accordance with EN 60669-1

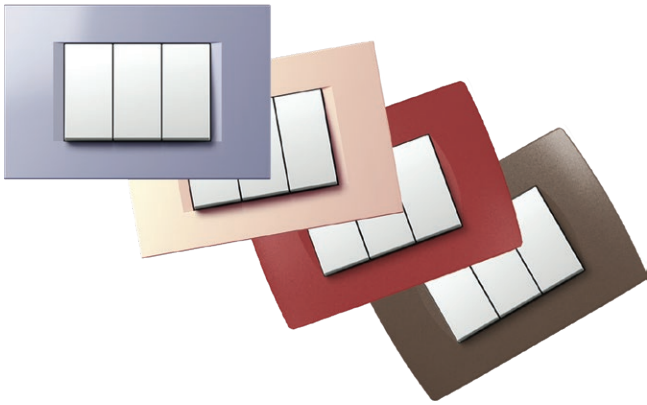









DEKORATION DER RAHMEN

- bei größeren Bestellungen fertigen wir dekorative Rahmen in Ihrer Wunschfarbe.
- geeignet für Rahmen OL, OS

COVER PLATES DECORATIONS

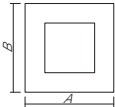
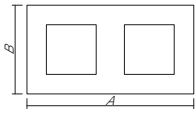
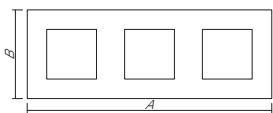
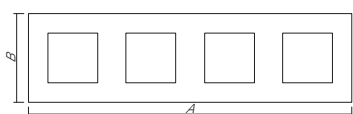
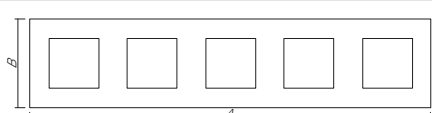
- when ordering large quantities, cover plates can be made in the colour of your choice
- suitable for cover plates OL, OS

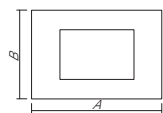
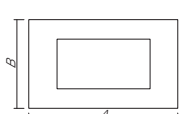
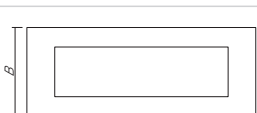
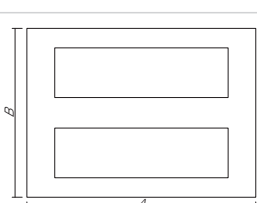
FRAMES

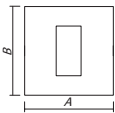
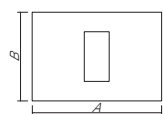
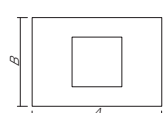
		 MODUL LINE A x B	 MODUL SOFT A x B	 MODUL PURE A x B
				
2M		80 x 80 mm	84 x 84 mm	93 x 90 mm
2x2M		151 x 80 mm	155 x 84 mm	164 x 90 mm
3x2M		222 x 80 mm	226 x 84 mm	235 x 90 mm
4x2M		293 x 80 mm	297 x 84 mm	304 x 90 mm
5x2M		364,1 x 80 mm		
				
3M		122 x 80 mm	122 x 84 mm	134 x 90 mm
4M		149 x 80 mm	144 x 84 mm	157 x 90 mm
7M		207 x 80 mm	212 x 84 mm	224 x 90 mm
2x7M			212 x 158 mm	
				
1/2M		80 x 80 mm	84 x 84 mm	
1/3M		122 x 80 mm	122 x 84 mm	134 x 90 mm
2/3M		122 x 80 mm	122 x 84 mm	134 x 90 mm

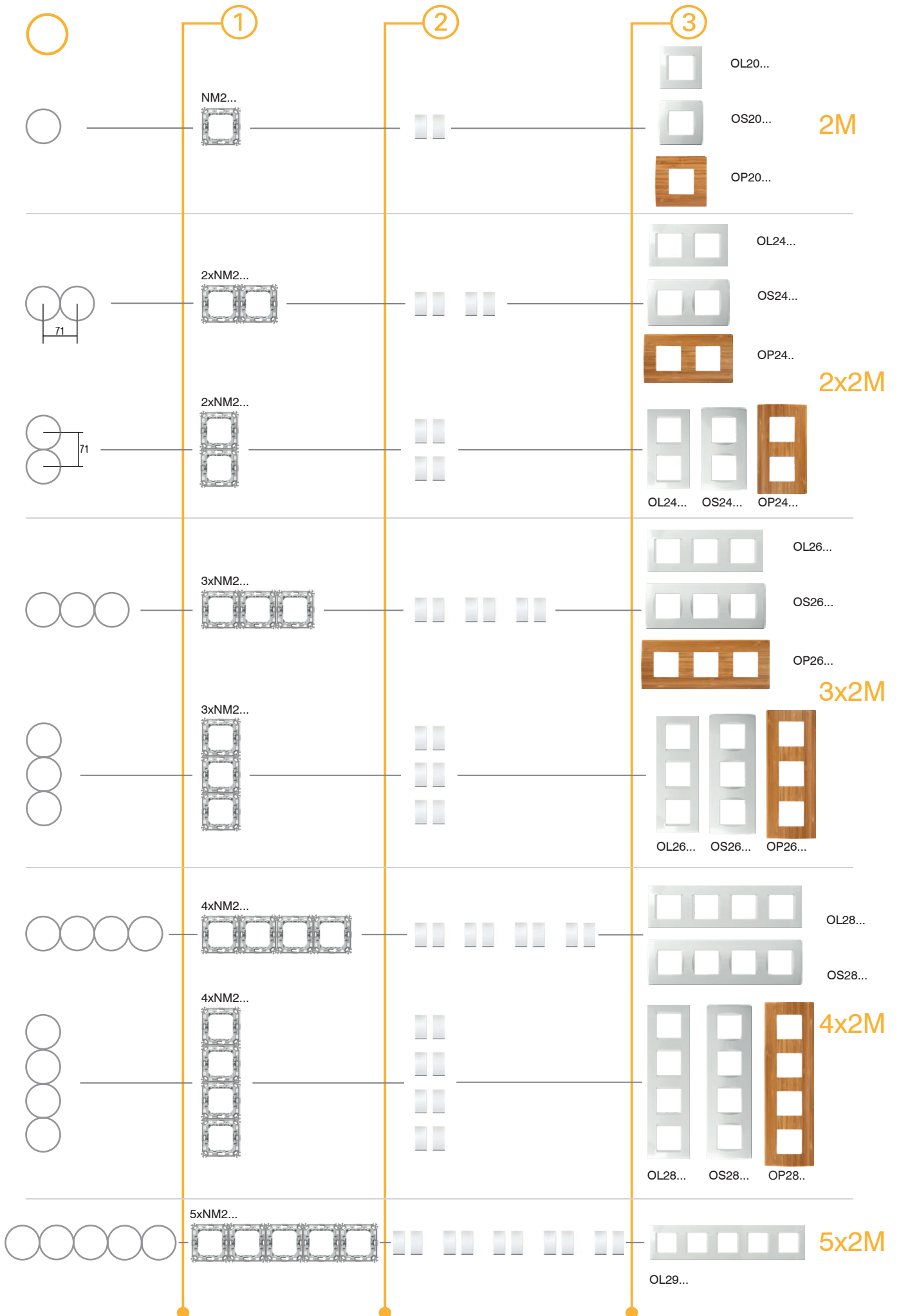

C O M B I N A T I O N S

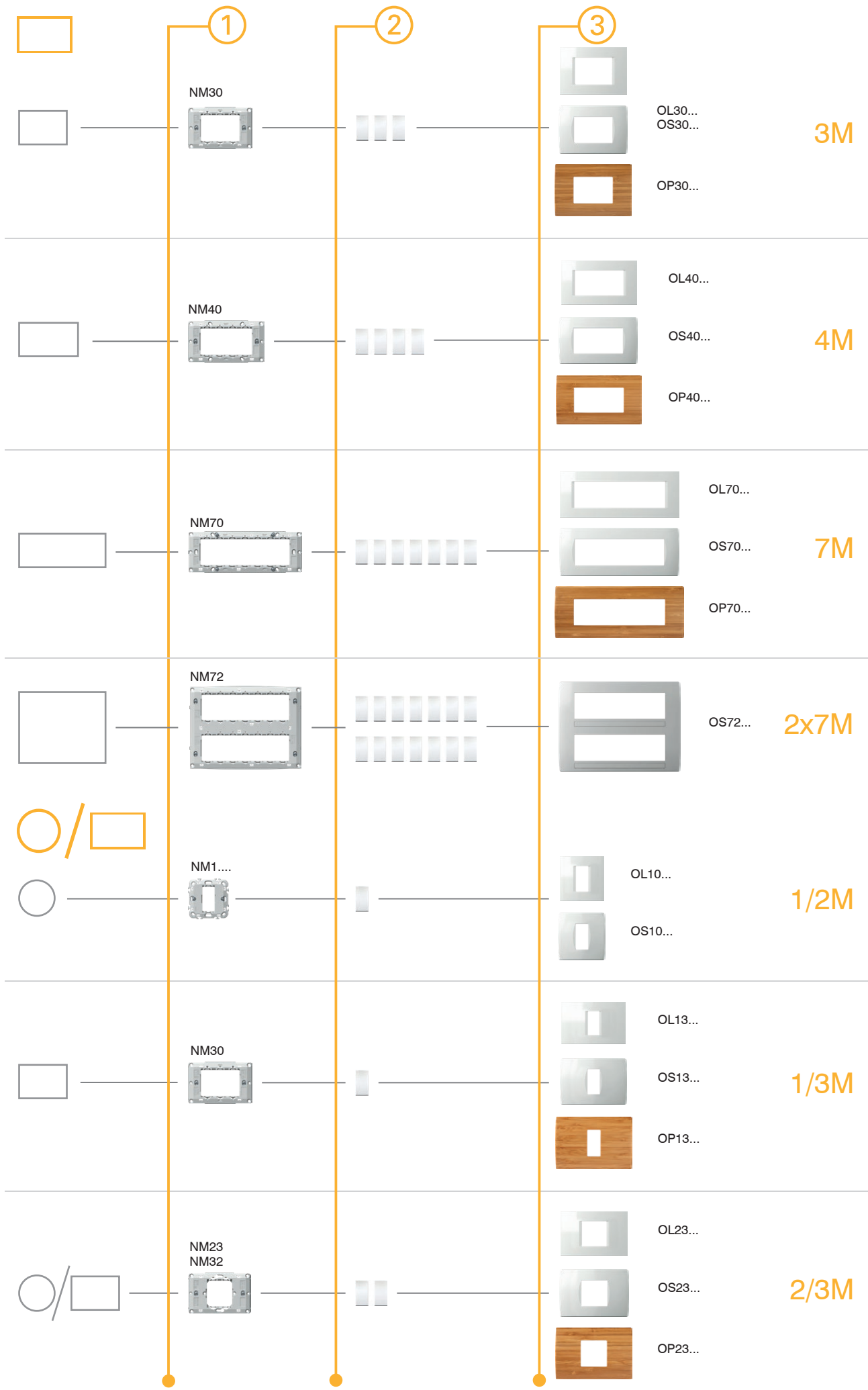

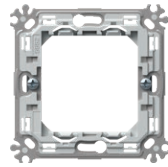

NM30

Typ type	Bezeichnung description	Größe size
NM10	MONTAGETRÄGER MIT KRALLEN MOUNTING FRAME WITH CLAWS	1/2M
NM11	MONTAGETRÄGER OHNE SCHRAUBEN MOUNTING FRAME WITHOUT SCREWS	1/2M
NM20	MONTAGETRÄGER MIT KRALLEN MOUNTING FRAME WITH CLAWS	2M
...



MONTAGETRÄGER MIT KRALLEN 2M

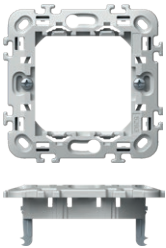

NM20

- Montageträger 2M mit Krallen
- Montage in der Wanddose Ø60 (DE..) mit Krallen
- Ermöglicht Steckmontage 2x2M, 3x2M und 4x2M in Horizontal- bzw. Vertikalrichtung
- geeignet für Rahmen LINE und SOFT
- entspricht EN 60669-1

MOUNTING FRAME WITH CLAWS 2M

- mounting frame 2M with claws
- for mounting on boxes Ø60 (DE..) with claws
- possible horizontal or vertical combinations 2x2M, 3x2M and 4x2M
- suitable for assembling with cover plates LINE and SOFT
- in accordance with EN 60669-1

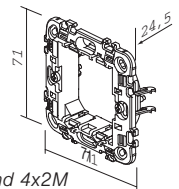

MONTAGETRÄGER OHNE SCHRAUBEN 2M

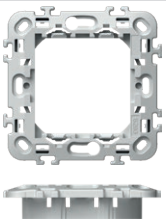

NM21

- Montageträger 2M ohne Schrauben bzw. Krallen
- Montage in der Wanddose Ø60 (HE.., BE..) mit Schrauben
- Ermöglicht Steckmontage 2x2M, 3x2M und 4x2M in Horizontal- bzw. Vertikalrichtung
- geeignet für Rahmen LINE und SOFT
- entspricht EN 60669-1

MOUNTING FRAME WITHOUT SCREWS 2M

- mounting frame 2M without screws and without claws
- for mounting on boxes Ø60 (HE.., BE..) with screws
- possible horizontal or vertical combinations 2x2M, 3x2M and 4x2M
- suitable for assembling with cover plates LINE and SOFT
- in accordance with EN 60669-1

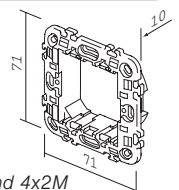

MONTAGETRÄGER METALL MIT KRALLEN 2M

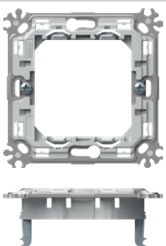

NM24

- Montageträger 2M aus Metall mit Krallen – steife Ausführung
- Montage in der Wanddose Ø60 (DE..) mit Krallen
- Ermöglicht Steckmontage 2x2M, 3x2M und 4x2M in Horizontal- bzw. Vertikalrichtung
- geeignet für Rahmen PURE, LINE und SOFT
- entspricht EN 60669-1

MOUNTING FRAME METAL WITH CLAWS 2M

- metal mounting frame 2M with claws - stiff version
- for mounting on boxes Ø60 (DE..) with claws
- possible horizontal or vertical combinations 2x2M, 3x2M and 4x2M
- suitable for assembling with cover plates PURE, LINE and SOFT
- in accordance with EN 60669-1

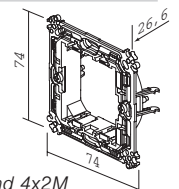

MONTAGETRÄGER METALL OHNE SCHRAUBEN 2M

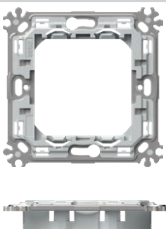

NM25

- Montageträger 2M aus Metall ohne Schrauben bzw. Krallen – steife Ausführung
- Montage in der Wanddose Ø60 (HE.., BE..) mit Schrauben
- Ermöglicht Steckmontage 2x2M, 3x2M und 4x2M in Horizontal- bzw. Vertikalrichtung
- geeignet für Rahmen PURE, LINE und SOFT
- entspricht EN 60669-1

MOUNTING FRAME METAL WITHOUT SCREWS 2M

- metal mounting frame 2M without screws and without claws - stiff version
- for mounting in boxes Ø60 (HE..., BE...) with screws
- possible horizontal or vertical combinations 2x2M, 3x2M and 4x2M
- suitable for assembling with cover plates PURE, LINE and SOFT
- in accordance with EN 60669-1

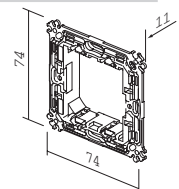

M O U N T I N G F R A M E S N M

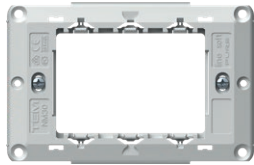

NM30

MONTAGETRÄGER MIT SCHRAUBEN 3M

- Montageträger 3M mit Schrauben
- Montage in Rechteckdosen 3M
- geeignet für Rahmen PURE, LINE und SOFT
- entspricht EN 60669-1

MOUNTING FRAME WITH SCREWS 3M

- mounting frame 3M with screws
- for mounting on rectangular boxes 3M
- suitable for assembling with cover plates PURE, LINE and SOFT
- in accordance with EN 60669-1

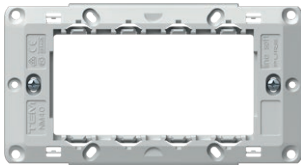
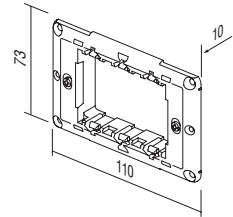

NM40

MONTAGETRÄGER MIT SCHRAUBEN 4M

- Montageträger 4M mit Schrauben
- Montage in Rechteckdosen 4M
- geeignet für Rahmen PURE, LINE und SOFT
- entspricht EN 60669-1

MOUNTING FRAME WITH SCREWS 4M

- mounting frame 4M with screws
- for mounting on rectangular boxes 4M
- suitable for assembling with cover plates PURE, LINE and SOFT
- in accordance with EN 60669-1

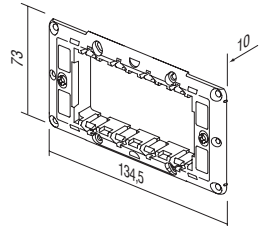

NM70

MONTAGETRÄGER MIT SCHRAUBEN 7M

- Montageträger 7M mit Schrauben
- Montage in Rechteckdosen 7M
- geeignet für Rahmen PURE, LINE und SOFT
- entspricht EN 60669-1

MOUNTING FRAME WITH SCREWS 7M

- mounting frame 7M with screws
- for mounting on rectangular boxes 7M
- suitable for assembling with cover plates PURE, LINE and SOFT
- in accordance with EN 60669-1

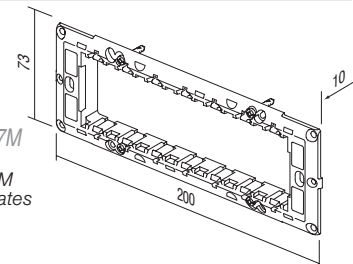

NM72

MONTAGETRÄGER MIT SCHRAUBEN 2x7M

- Montageträger 2x7M mit Schrauben
- Montage in Rechteckdosen 2x7M
- geeignet für Rahmen SOFT OS72
- entspricht EN 60669-1

MOUNTING FRAME WITH SCREWS 2x7M

- mounting frame 2x7M with screws
- for mounting on rectangular boxes 2x7M
- suitable for assembling with cover plate SOFT OS72
- in accordance with EN 60669-1

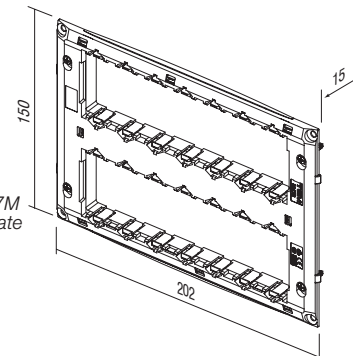



	<p>NM10</p>	<p>MONTAGETRÄGER MIT KRALLEN 1/2M</p> <ul style="list-style-type: none"> - Montageträger 1/2M mit Krallen - Montage in der Wanddose Ø60 (DE..) mit Krallen - geeignet für Rahmen LINE und SOFT - entspricht EN 60669-1 <p><i>MOUNTING FRAME WITH CLAWS 1/2M</i></p> <ul style="list-style-type: none"> - mounting frame 1/2M with claws - for mounting on boxes Ø60 (DE..) with claws - suitable for assembling with cover plates LINE and SOFT - in accordance with EN 60669-1 	
	<p>NM11</p>	<p>MONTAGETRÄGER OHNE SCHRAUBEN 1/2M</p> <ul style="list-style-type: none"> - Montageträger 1/2M ohne Schrauben bzw. Krallen - Montage in der Wanddose Ø60 (HE... BE..) mit Schrauben - geeignet für Rahmen LINE und SOFT - entspricht EN 60669-1 <p><i>MOUNTING FRAME WITHOUT SCREWS 1/2M</i></p> <ul style="list-style-type: none"> - mounting frame 1/2M without screws and without claws - for mounting on boxes Ø60 (HE..., BE..) with screws - suitable for assembling with cover plates LINE and SOFT - in accordance with EN 60669-1 	
	<p>NM23</p>	<p>MONTAGETRÄGER MIT KRALLEN 2/3M</p> <ul style="list-style-type: none"> - Montageträger 2/3M mit Krallen - Montage in der Wanddose Ø60 (DE..) mit Krallen - geeignet für Rahmen PURE, LINE und SOFT - entspricht EN 60669-1 <p><i>MOUNTING FRAME WITH CLAWS 2/3M</i></p> <ul style="list-style-type: none"> - mounting frame 2/3M with claws - for mounting on boxes Ø60 (DE..) with claws - suitable for assembling with cover plates PURE, LINE and SOFT - in accordance with EN 60669-1 	
	<p>NM32</p>	<p>MONTAGETRÄGER MIT SCHRAUBEN 2/3M</p> <ul style="list-style-type: none"> - Montageträger 2/3M mit Schrauben - Montage in Rechteckdosen 3M - geeignet für Rahmen PURE, LINE und SOFT - entspricht EN 60669-1 <p><i>MOUNTING FRAME WITH SCREWS 2/3M</i></p> <ul style="list-style-type: none"> - mounting frame 2/3M with screws - for mounting on rectangular boxes 3M - suitable for assembling with cover plates PURE, LINE and SOFT - in accordance with EN 60669-1 	



110



118



126



128





DOSEN

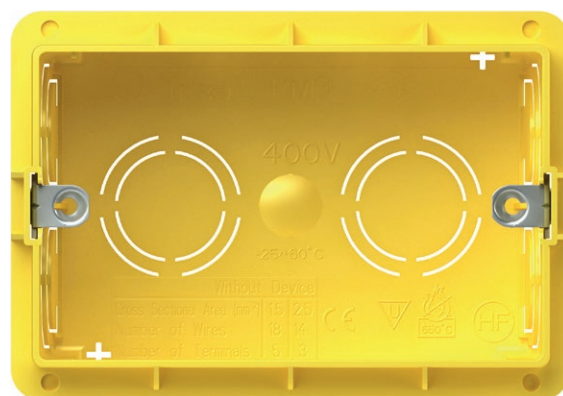

TEM



DE12



HE11



BE10

Typ type	Bezeichnung description	Größe size
DE10	RUNDDOSE ZIEGELWAND ROUND BOX BRICK	SM60-01
HE10	RUNDDOSE HOHLWAND ROUND BOX HOLLOW WALL	SM68X40
BE10	RUNDDOSE BETONWAND ROUND BOX CONCRETE	
·	·	·
·	·	·

RUNDDOSE ZIEGELWAND SM60-01



DE10

- Durchmesser Ø60 mm, Tiefe 40mm
- 650°C, 500V~
- entspricht IEC 60670-1
- ohne Halogen
- Möglichkeit der Befestigung des Montageträgers mit der Schraube Ø 3mm

ROUND BOX BRICK SM60-01

- Ø60, depth 40mm
- 650°C, 500V~
- in accordance with IEC 60670-1
- halogen free
- option of mounting the mounting frame with Ø 3 mm screws

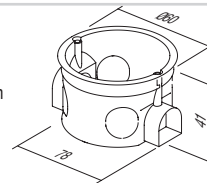

RUNDDOSE ZIEGELWAND TIEF SM60-06



DE11

- Durchmesser Ø60 mm, Tiefe 60 mm
- 650°C, 500V~
- entspricht IEC 60670-1
- ohne Halogen
- Möglichkeit der Befestigung des Montageträgers mit der Schraube Ø 3mm

ROUND BOX BRICK DEEP SM60-06

- Ø60, depth 60mm
- 650°C, 500V~
- in accordance with IEC 60670-1
- halogen free
- option of mounting the mounting frame with Ø 3 mm screws

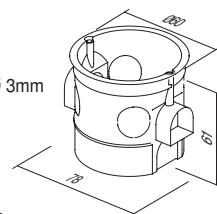

ABSTANDSTUTZEN SM60-03



DE30

- für vertikale Mehrfachkombinationen von Dosen SM60-06 bzw. SM60-01 auf einer Distanz von 91 mm
- entspricht IEC 60670-1
- ohne Halogen

COMBI-CLIP SM60-03

- for vertical fitting of boxes SM60-06 or SM60-01 on distance 91 mm
- in accordance with IEC 60670-1
- halogen free



ABSTANDSTUTZEN SM60-04

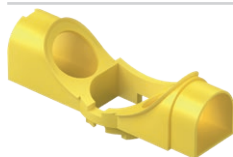

DE31

- für horizontale Mehrfachkombinationen von Dosen SM60-06 bzw. SM60-01 auf einer Distanz von 71 mm
- entspricht IEC 60670-1,
- ohne Halogen

COMBI-CLIP SM60-04

- for horizontal fitting of boxes SM60-06 or SM60-01 on distance 71mm
- in accordance with IEC 60670-1
- halogen free

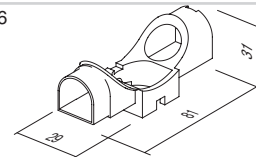

R O U N D B O X E S

	DE12	RUNDDOSE ZIEGELWAND MD65-46	<ul style="list-style-type: none"> - Durchmesser Ø60 mm, Tiefe 46 mm - 650 °C, 500V~ - entspricht IEC 60670-1 - ohne Halogen - Möglichkeit der Befestigung des Montageträgers mit der Schraube Ø 3 mm 	
		ROUND BOX BRICK MD65-46	<ul style="list-style-type: none"> - Ø65, depth 46mm - 650 °C, 500V~ - in accordance with IEC 60670-1 - halogen free - option of mounting the mounting frame with Ø 3 mm screws 	
	DE13	RUNDDOSE ZIEGELWAND TIEF MD65-60	<ul style="list-style-type: none"> - Durchmesser Ø65/60 mm, Tiefe 62mm - 650 °C, 500V~ - entspricht IEC 60670-1 - ohne Halogen - Möglichkeit der Befestigung des Montageträgers mit der Schraube Ø 3 mm 	
		ROUND BOX BRICK DEEP MD65-60	<ul style="list-style-type: none"> - Ø65/60, depth 62mm - 650 °C, 500V~ - in accordance with IEC 60670-1 - halogen free - option of mounting the mounting frame with Ø 3 mm screws 	
	DE14	VERLÄNGERUNG FÜR RUNDDOSE ZIEGELWAND MD65-46	<ul style="list-style-type: none"> - Durchmesser Ø65/60 mm, Tiefe 17 mm - 650 °C, 500V~ - entspricht IEC 60670-1 - ohne Halogen 	
		ADDITIONAL PIECE FOR MD65-46	<ul style="list-style-type: none"> - Ø65/60, depth 17mm - 650 °C, 500V~ - in accordance with IEC 60670-1 - halogen free 	
	DE32	ABSTANDSTUTZEN MD65-71	<ul style="list-style-type: none"> - zur Verbindung von Dosen MD65 auf eine Distanz von 71 mm - entspricht IEC 60670-1 - ohne Halogen 	
		COMBI-CLIP MD65-71	<ul style="list-style-type: none"> - for fitting of boxes MD65 on distance 71mm - in accordance with IEC 60670-1 - halogen free 	
	DE33	ABSTANDSTUTZEN MD65-91	<ul style="list-style-type: none"> - zur Verbindung von Dosen MD65 auf eine Distanz von 91mm - entspricht IEC 60670-1 - ohne Halogen 	
		COMBI-CLIP MD65-91	<ul style="list-style-type: none"> - for fitting of boxes MD65 on distance 91mm - in accordance with IEC 60670-1 - halogen free 	
	DE20	FEDERDECKEL 60	<ul style="list-style-type: none"> - Federdeckel für Runddosen Ø60 für DE10, DE11, DE13, DE14 - entspricht IEC 60670-1 - zum Schutz beim Verputzen 	
		BOX COVER PROTECTIVE 60	<ul style="list-style-type: none"> - protective cover for box Ø60 for DE10, DE11, DE13, DE14 - in accordance with IEC 60670-1 - box protection during plastering 	
	DE21	FEDERDECKEL 65	<ul style="list-style-type: none"> - Federdeckel für Runddosen Ø65 für DE12 - entspricht IEC 60670-1 - zum Schutz beim Verputzen 	
		BOX COVER PROTECTIVE 65	<ul style="list-style-type: none"> - protective cover for box Ø65 for DE12 - in accordance with IEC 60670-1 - box protection during plastering 	
	DE22	ABDECKUNG DEKORATIV SM60	<ul style="list-style-type: none"> - dekorative Abdeckung für Runddosen Ø60 - entspricht IEC 60670-1 - ohne Halogen 	
		BOX COVER DECORATIVE SM60	<ul style="list-style-type: none"> - decorative cover for boxes Ø60 - in accordance with IEC 60670-1 - halogen free 	



Montageanleitung /
assembly instructions

Abstand zwischen Dosen /
distance between boxes: 71 mm

Abstand zwischen Dosen /
distance between boxes: 91 mm

DE10,11

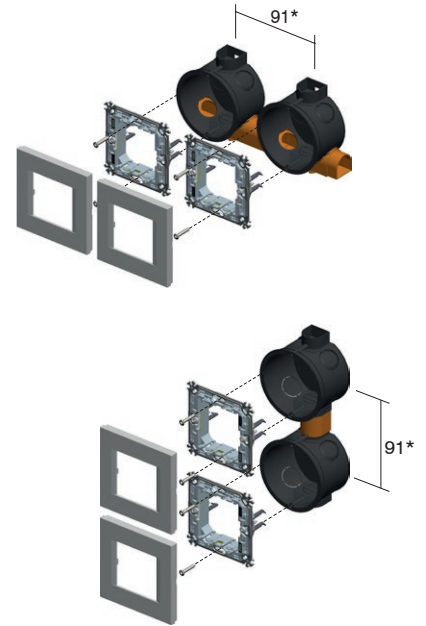
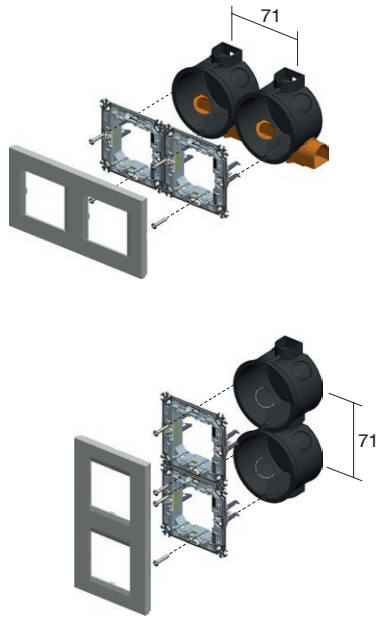
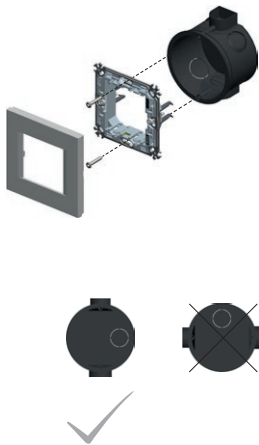

DE12,13

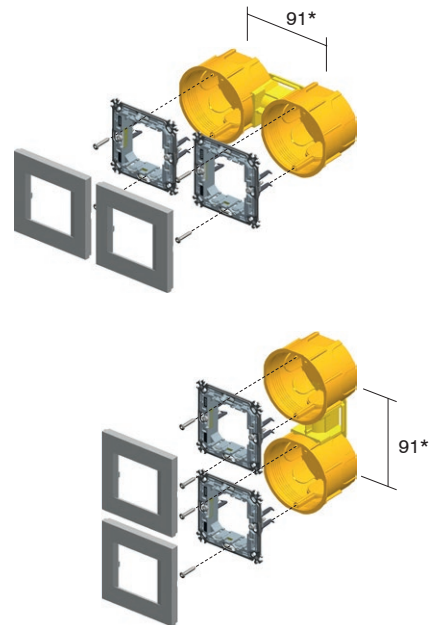
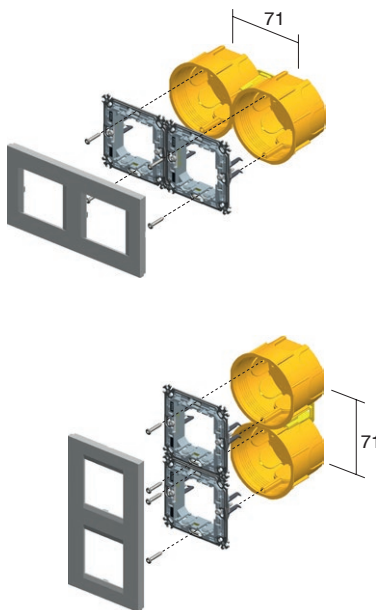
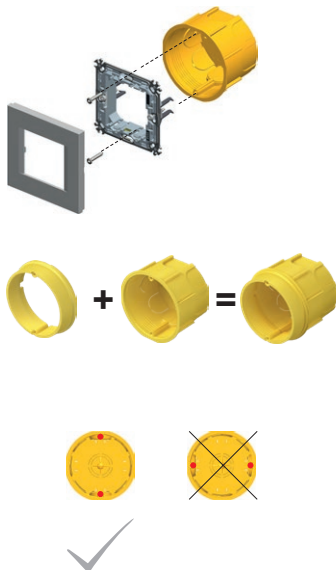

* für Rahmen PURE beträgt der Abstand zwischen Dosen
100 mm
* for PURE cover plates the minimum distance between
boxes is 100mm

R O U N D B O X E S



DE10,11



DE12,13



NM20



NM24



DE10,11



DE12,13



NM10



DE10,11



DE12,13



NM23



71

2xDE10,11 + 2xDE31



2xNM20



2xDE12,13 + 1xDE32



2xNM24



2xDE10,11 2xDE12,13 + 1xDE32



2xNM20



2xNM24



3xDE10,11 + 3xDE31



3xNM20



3xDE12,13 + 2xDE32



3xNM24

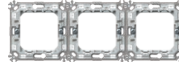

3xDE10,11 3xDE12,13 + 2xDE32

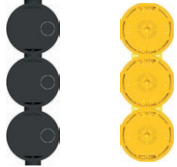

3xNM20



3xNM24



4xDE10,11 + 4xDE31



4xNM20



4xDE12,13 + 3xDE32



4xNM24



4xDE10,11 4xDE12,13 + 3xDE32

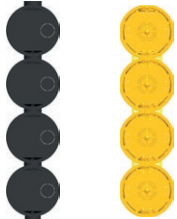

4xNM20



4xNM24



5xDE10,11

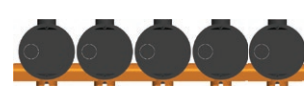

5xNM20



5xDE12,13 + 4xDE32



5xNM24



RUNDDOSE HOHLWAND SM68x40



HE10

- Durchmesser Ø60 mm, Tiefe 40mm
- Einbauloch Ø68
- 850°C, 400V~
- entspricht IEC 60670-1
- Montage mit Krallen
- ohne Halogen
- Befestigung des Montageträgers mit Schrauben Ø 3 mm

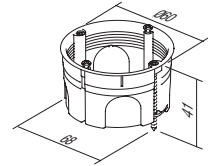

ROUND BOX HOLLOW WALL SM68x40

- Ø60, depth 40mm
- cutting hole Ø68
- 850°C, 400V~
- in accordance with IEC 60670-1
- mounting with claws
- halogen free
- mounting the mounting frame with Ø 3 mm screws

RUNDDOSE HOHLWAND SM68x55



HE11

- Durchmesser Ø60 mm, Tiefe 55mm
- Einbauloch Ø68
- 850°C, 400V~
- entspricht IEC 60670-1
- Montage mit Krallen
- ohne Halogen
- Befestigung des Montageträgers mit Schrauben Ø 3 mm

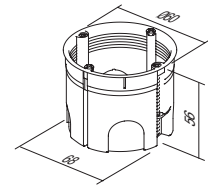

ROUND BOX HOLLOW WALL SM68x55

- Ø60, depth 55mm
- cutting hole Ø68
- 850°C, 400V~
- in accordance with IEC 60670-1
- mounting with claws
- halogen free
- mounting the mounting frame with Ø 3 mm screws

RUNDDOSE BETONWAND



BE10

- Durchmesser Ø60 mm, Tiefe 49mm
- 650°C, 500V~
- entspricht IEC 60670-1
- ohne Halogen
- Befestigung des Montageträgers mit Schrauben Ø 3 mm

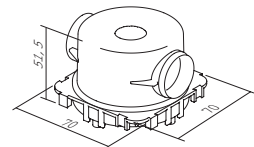

ROUND BOX CONCRETE

- Ø60mm, depth 49mm
- 650°C, 500V~
- in accordance with IEC 60670-1
- halogen free
- mounting the mounting frame with Ø 3 mm screws

RUNDDOSE BETONWAND TIEF



BE11

- Durchmesser Ø60 mm, Tiefe 58 mm
- 650°C, 500V~
- entspricht IEC 60670-1
- ohne Halogen
- Befestigung des Montageträgers mit Schrauben Ø 3 mm

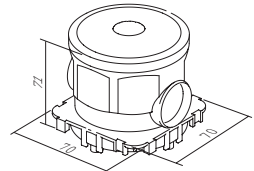

ROUND BOX CONCRETE DEEP

- Ø60mm, depth 58mm
- 650°C, 500V~
- in accordance with IEC 60670-1
- halogen free
- mounting the mounting frame with Ø 3 mm screws

GEGENLAGER FÜR RUNDDOSE BETONWAND



BE20

- zur Abstützung der Dose durch ein Distanzprofil BM82 in die Gegenwand
- entspricht IEC 60670-1
- ohne Halogen

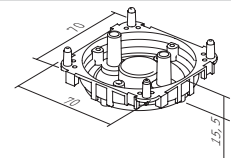

COUNTER BOX SUPPORT CONCRETE

- to support concrete boxes with discance profile BM82 for extreme loads
- in accordance with IEC 60670-1
- halogen free

ROHREINFÜHRUNG 16 FÜR RUNDDOSE BETONWAND



BE21

- für Rohrfixierung auch bei größeren Belastungen
- entspricht IEC 60670-1
- ohne Halogen

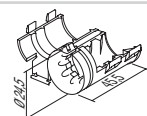

PIPE STOPPER CONCRETE BOX 16

- for firming installation pipe to box
- in accordance with IEC 60670-1
- halogen free

R O U N D B O X E S

Hohlwand/ hollow walls



Betonwand/ concrete



Montageanleitung/
assembly instructions

Abstand zwischen Dosen /
distance between boxes: 71 mm

Abstand zwischen Dosen /
distance between boxes: 91 mm

HE10,11

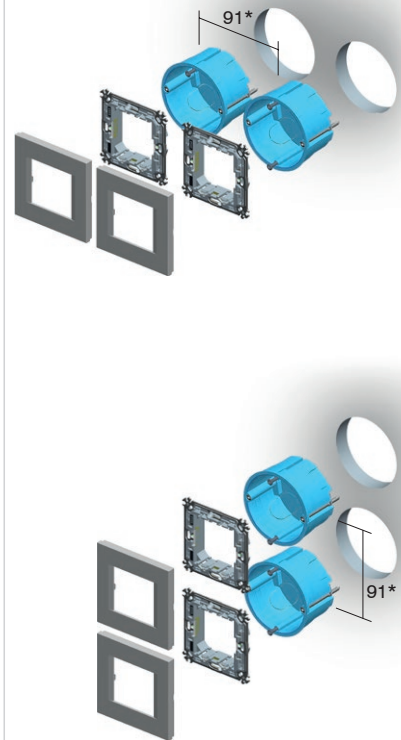
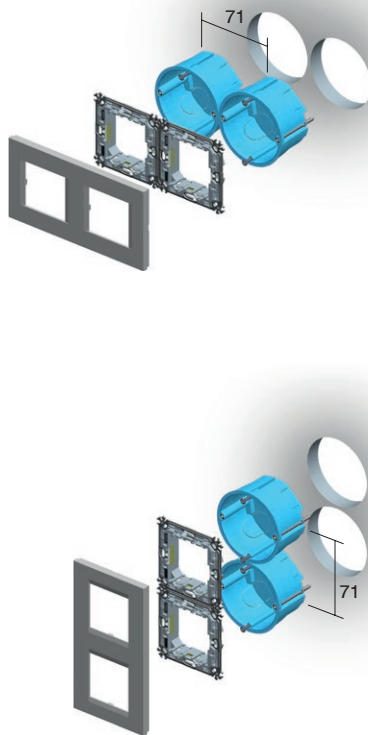
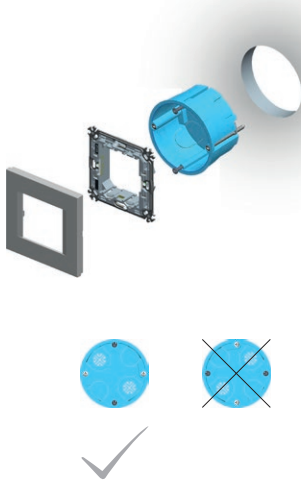

BE10

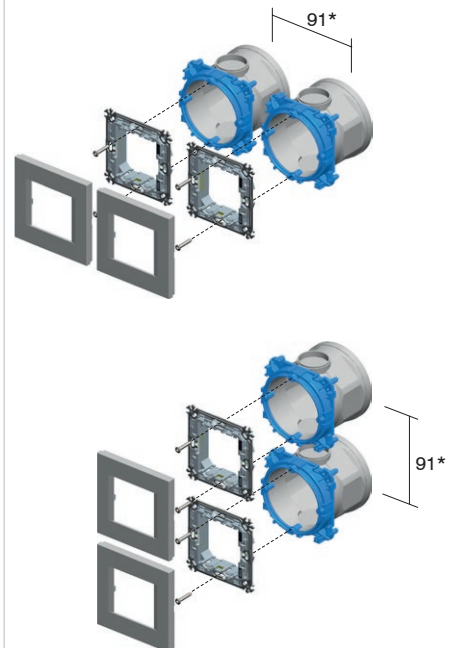
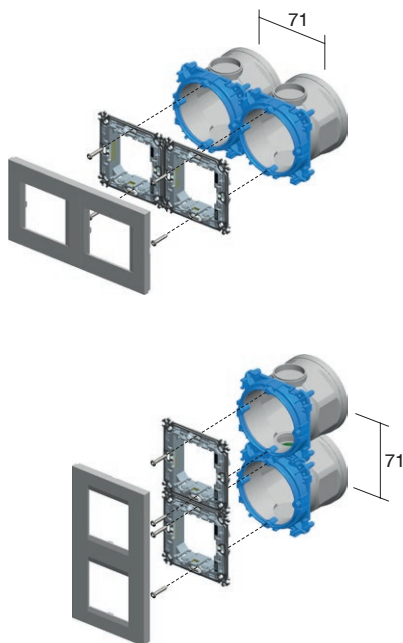
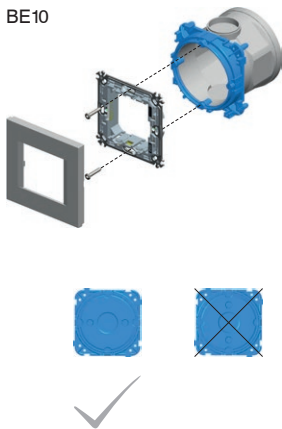

* für Rahmen PURE beträgt der Abstand zwischen Dosen 100 mm

* for PURE cover plates the minimum distance between boxes is 100mm

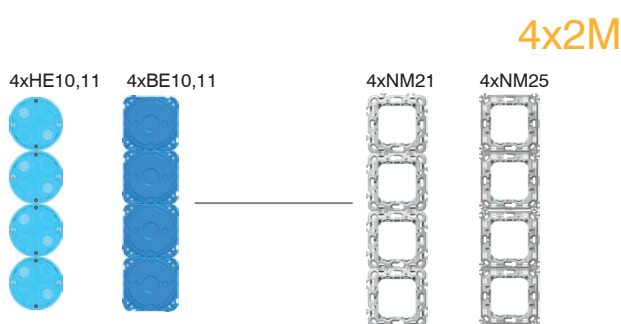
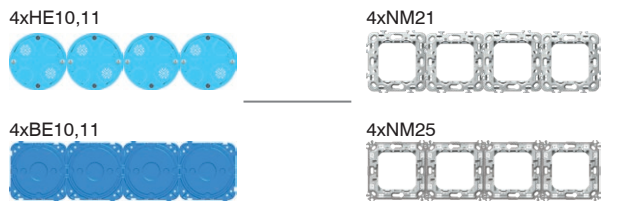
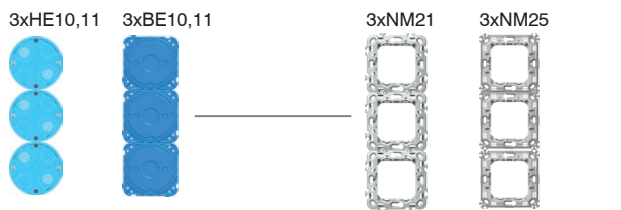
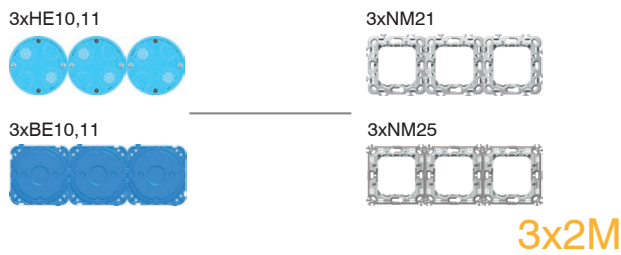
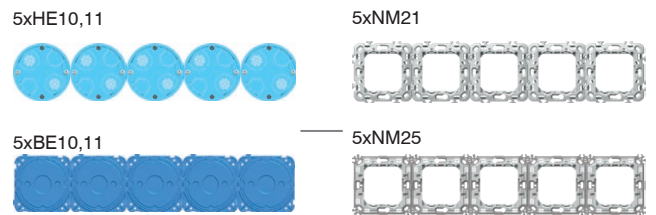
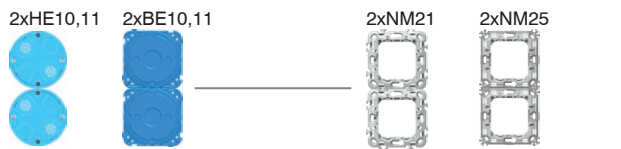
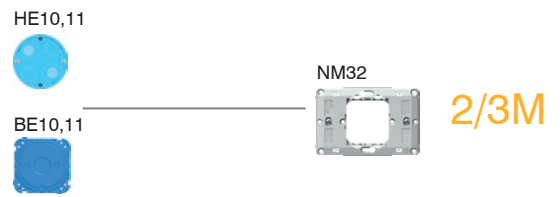
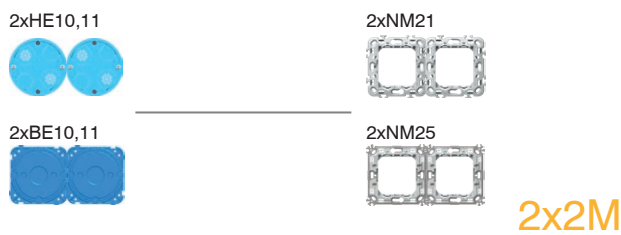
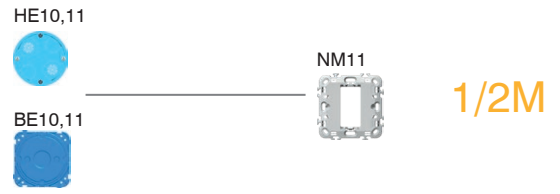
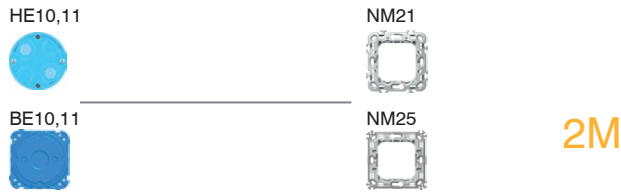
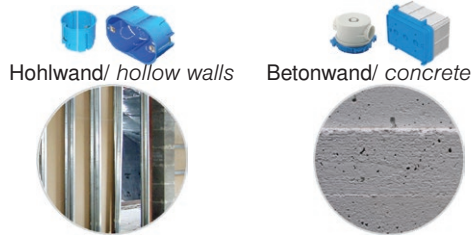

R O U N D B O X E S

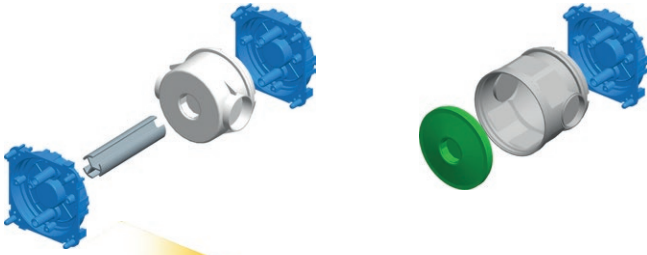

Montageanleitung/
assembly instructions

1

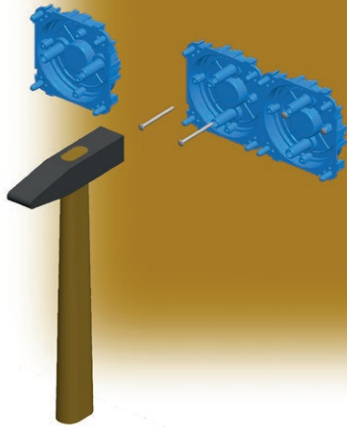

3

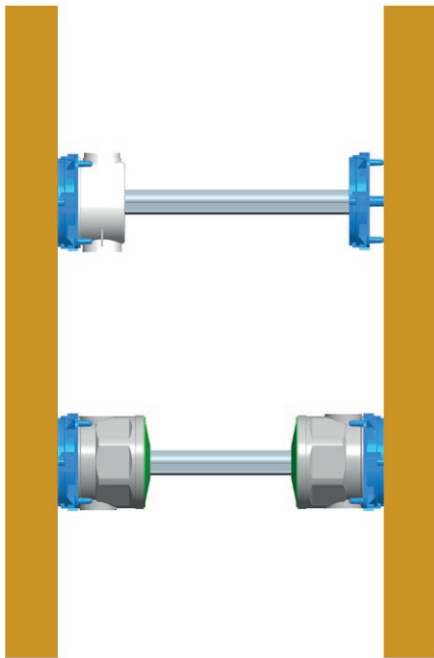

2

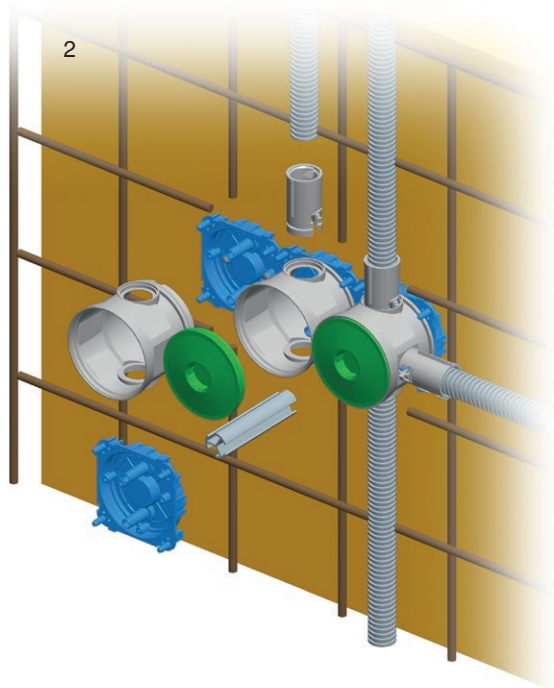

4

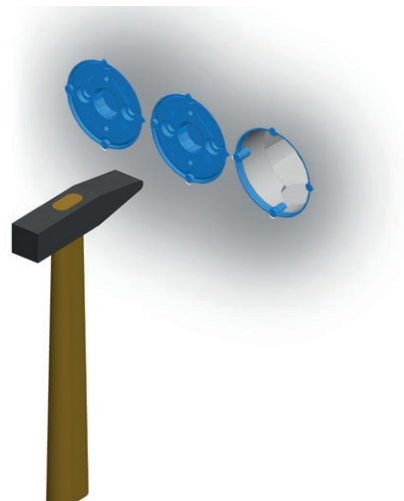



DM30



HM30



BM30

Typ type	Bezeichnung description	Größe size
DM30	RECHTECKDOSE ZIEGELWAND RECTANGULAR BOX BRICK	PM3
HM30	RECHTECKDOSE HOHLWAND RECTANGULAR BOX HOLLOW WALL	VM3
BM30	RECHTECKDOSE BETONWAND RECTANGULAR BOX CONCRETE	BM3
·	·	·
·	·	·

RECHTECKDOSE ZIEGELWAND PM3



DM30

- Breite 3M, Tiefe 49mm
- 650°C, 400V~
- entspricht IEC 60670-1
- ohne Halogen

RECTANGULAR BOX BRICK PM3

- size 3M, depth 49mm
- 650°C, 400V~
- in accordance with IEC 60670-1
- halogen free

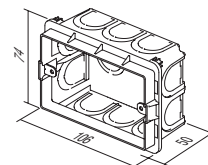

RECHTECKDOSE ZIEGELWAND PM3-65



DM31

- Breite 3M, Tiefe 65mm
- 650°C, 400V~
- entspricht IEC 60670-1
- ohne Halogen

RECTANGULAR BOX BRICK PM3-65

- size 3M, depth 65mm
- 650°C, 400V~
- in accordance with IEC 60670-1
- halogen free

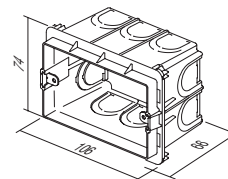

RECHTECKDOSE ZIEGELWAND PM4



DM40

- Breite 4M, Tiefe 49mm
- 650°C, 400V~
- entspricht IEC 60670-1
- ohne Halogen

RECTANGULAR BOX BRICK PM4

- size 4M, depth 49mm
- 650°C, 400V~
- in accordance with IEC 60670-1
- halogen free

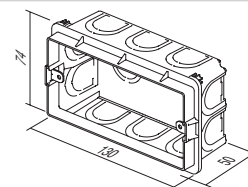

RECHTECKDOSE ZIEGELWAND PM4-65



DM41

- Breite 4M, Tiefe 65 mm
- 650°C, 400V~
- entspricht IEC 60670-1
- ohne Halogen

RECTANGULAR BOX BRICK PM4-65

- size 4M, depth 65mm
- 650°C, 400V~
- in accordance with IEC 60670-1
- halogen free

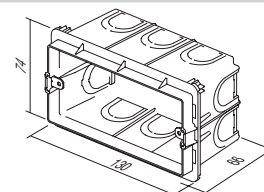

R E C T A N G U L A R B O X E S

DM70 **RECHTECKDOSE ZIEGELWAND PM7**

- Breite 7M, Tiefe 49mm
- 650°C, 400V~
- entspricht IEC 60670-1
- ohne Halogen

RECTANGULAR BOX BRICK PM7

- size 7M, depth 49mm
- 650°C, 400V~
- in accordance with IEC 60670-1
- halogen free

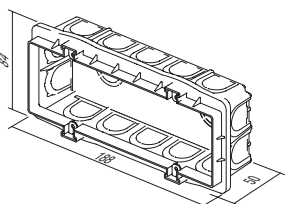
DM71 **RECHTECKDOSE ZIEGELWAND PM7-65**

- Breite 7M, Tiefe 65mm
- 650°C, 400V~
- entspricht IEC 60670-1
- ohne Halogen

RECTANGULAR BOX BRICK PM7-65

- size 7M, depth 65mm
- 650°C, 400V~
- in accordance with IEC 60670-1
- halogen free





DM72 **RECHTECKDOSE ZIEGELWAND PM72-65**

- Breite 2x7M, Tiefe 64mm
- 650°C, 400V~
- entspricht IEC 60670-1
- ohne Halogen

RECTANGULAR BOX BRICK PM72-65

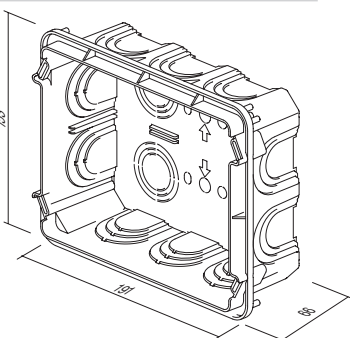
- size 2x7M, depth 64mm
- 650°C, 400V~
- in accordance with IEC 60670-1
- halogen free





DM80 **ABSTANDHALTER FÜR RECHTECKDOSEN PM**

- ermöglicht Vertikal- (A) und Horizontalmontage (B) von mehreren Rechteckdosen PM3, PM4 und PM7 auf eine feste Distanz
- Geeignet für Rahmen LINE und SOFT (nicht geeignet für Rahmen PURE)

DISTANCE PIECE FOR BOX PM

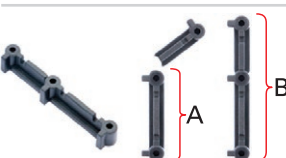
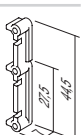
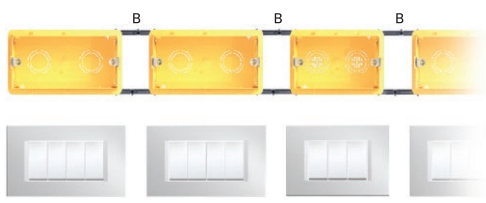
- for vertical (A) and horizontal (B) fitting of boxes PM3, PM4 and PM7
- suitable for Line and Soft decorative cover plates (not for PURE)



DM33

FEDERDECKEL PM3

- Federdeckel für Rechteckdosen PM3
- entspricht IEC 60670-1
- ohne Halogen
- zum Schutz beim Verputzen

BOX COVER PROTECTIVE PM3

- protective cover for box PM3
- in accordance with IEC 60670-1
- halogen free
- box protection during plastering

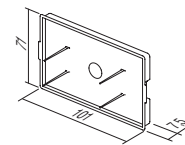

DM34

ABDECKUNG DEKORATIV PM3

- dekorative Abdeckung für Rechteckdosen 3M
- inkl. Schrauben
- entspricht IEC 60670-1
- ohne Halogen

BOX COVER DECORATIVE PM3

- decorative cover for boxes 3M
- screws are included
- in accordance with IEC 60670-1
- halogen free

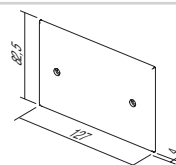

DM43

FEDERDECKEL PM4

- Federdeckel für Rechteckdosen PM4
- entspricht IEC 60670-1
- ohne Halogen
- zum Schutz beim Verputzen

BOX COVER PROTECTIVE PM4

- protective cover for box PM4
- in accordance with IEC 60670-1
- halogen free
- box protection during plastering

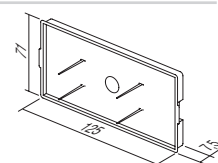

DM44

ABDECKUNG DEKORATIV PM4

- dekorative Abdeckung für Rechteckdosen 4M
- inkl. Schrauben
- entspricht IEC 60670-1
- ohne Halogen

BOX COVER DECORATIVE PM4

- decorative cover for boxes 4M
- screws are included
- in accordance with IEC 60670-1
- halogen free

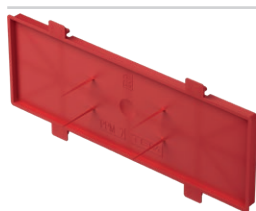
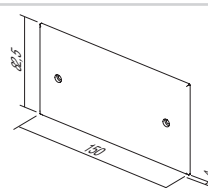

DM73

FEDERDECKEL PM7

- Federdeckel für Rechteckdosen PM7
- entspricht IEC 60670-1
- ohne Halogen
- zum Schutz beim Verputzen

BOX COVER PROTECTIVE PM7

- protective cover for box PM7
- in accordance with IEC 60670-1
- halogen free
- box protection during plastering

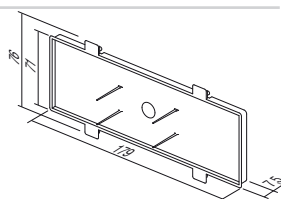

DM74

ABDECKUNG DEKORATIV PM7

- dekorative Abdeckung für Rechteckdosen 7M
- inkl. Schrauben
- entspricht IEC 60670-1
- ohne Halogen

BOX COVER DECORATIVE PM7

- decorative cover for boxes 7M
- screws are included
- in accordance with IEC 60670-1
- halogen free

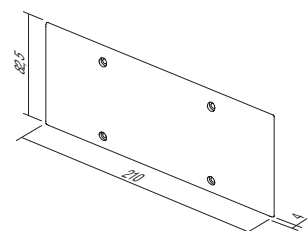

R E C T A N G U L A R B O X E S



DM75

ABDECKUNG DEKORATIV PM72

- dekorative Abdeckung für Rechteckdosen 2x7M
- inkl. Schrauben
- entspricht IEC 60670-1

BOX COVER DECORATIVE PM72

- decorative cover for boxes 2x7M
- screws are included
- in accordance with IEC 60670-1

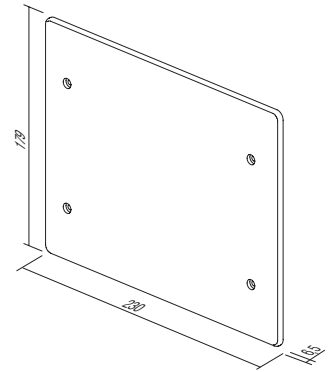

RECHTECKDOSE HOHLWAND VM3



HM30

- Breite 3M, Tiefe 49mm
- Einbauloch 2xØ68/45mm
- 850°C, 400V~
- entspricht IEC 60670-1
- ohne Halogen

RECTANGULAR BOX HOLLOW WALL VM3

- size 3M, depth 49mm
- cutting hole 2xØ68/45mm
- 850°C, 400V~
- in accordance with IEC 60670-1
- halogen free

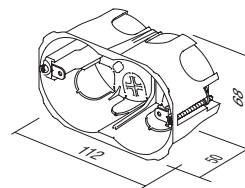

RECHTECKDOSE HOHLWAND VM4



HM40

- Breite 4M, Tiefe 49mm
- Einbauloch 2xØ68/70mm
- 850°C, 400V~
- entspricht IEC 60670-1
- ohne Halogen

RECTANGULAR BOX HOLLOW WALL VM4

- size 4M, depth 49mm
- cutting hole 2xØ68/70mm
- 850°C, 400V~
- in accordance with IEC 60670-1
- halogen free

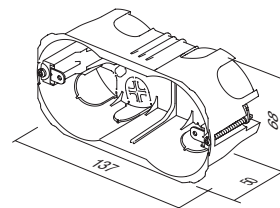

RECHTECKDOSE HOHLWAND VM7



HM70

- Breite 7M, Tiefe 49mm
- Einbauloch 2xØ68/120 mm
- 850°C, 400V~
- entspricht IEC 60670-1
- ohne Halogen

RECTANGULAR BOX HOLLOW WALL VM7

- size 7M, depth 49mm
- cutting hole 2xØ68/120mm
- 850°C, 400V~
- in accordance with IEC 60670-1
- halogen free

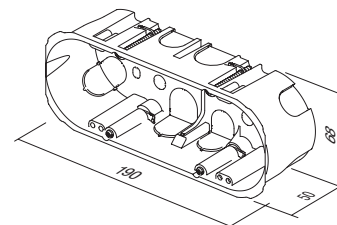

RECHTECKDOSE HOHLWAND VM72



HM72







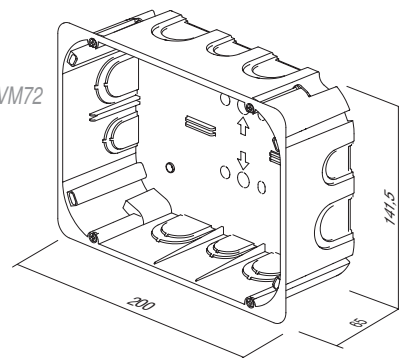

- Breite 2x7M, Tiefe 63mm
- 850°C, 400V~
- entspricht IEC 60670-1
- ohne Halogen

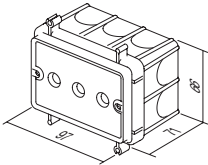
RECTANGULAR BOX HOLLOW WALL VM72

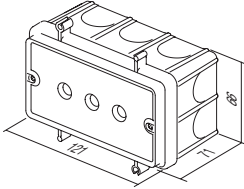
- size 2x7M, depth 63mm
- 850°C, 400V~
- in accordance with IEC 60670-1
- halogen free

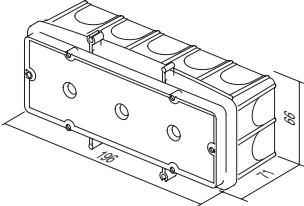

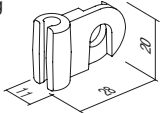
R E C T A N G U L A R B O X E S

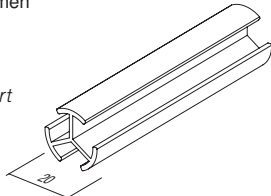
	BM30	RECHTECKDOSE BETONWAND BM3 - Breite 3M, Tiefe 60 mm - 650°C, 400V~ - entspricht IEC 60670-1 - ohne Halogen	
	BM40	RECHTECKDOSE BETONWAND BM4 - Breite 4M, Tiefe 60 mm - 650°C, 400V~ - entspricht IEC 60670-1 - ohne Halogen	
	BM70	RECHTECKDOSE BETONWAND BM7 - Breite 7M, Tiefe 60 mm - 650°C, 400V~ - entspricht IEC 60670-1 - ohne Halogen	
	BM80	BEFESTIGUNGSELEMENT FÜR DOSEN BM - für schnelle Befestigung von Rechteckdosen BM auf die Bewehrung - geeignet für Stäbe bis Durchmesser Ø8 mm	
	BM82	DISTANZPROFIL FÜR DOSEN - zur Abstützung von Rechteckdosen BM zusammen mit deren Träger in die Gegenwand - Länge l=1m, Durchmesser Ø20 mm	
		RECTANGULAR BOX CONCRETE BM3 - size 3M, depth 60mm - 650°C, 400V~ - in accordance with IEC 60670-1 - halogen free	
		RECTANGULAR BOX CONCRETE BM4 - size 4M, depth 60mm - 650°C, 400V~ - in accordance with IEC 60670-1 - halogen free	
		RECTANGULAR BOX CONCRETE BM7 - size 7M, depth 60mm - 650°C, 400V~ - in accordance with IEC 60670-1 - halogen free	
		FIXING COMBI-CLIP BM - for fast fixation of BM rectangular boxes on reinforcing bar - suitable for bar diameter up to Ø8mm	
		DISTANCE PROFIL FOR BOXES BM - to support boxes BM with counter box support on opposite wall - length l=1m, diameter Ø20mm	

R E C H T E C K D O S E N

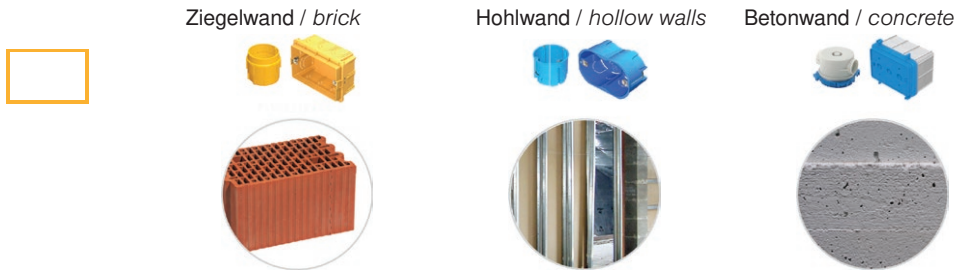

R E C T A N G U L A R B O X E S

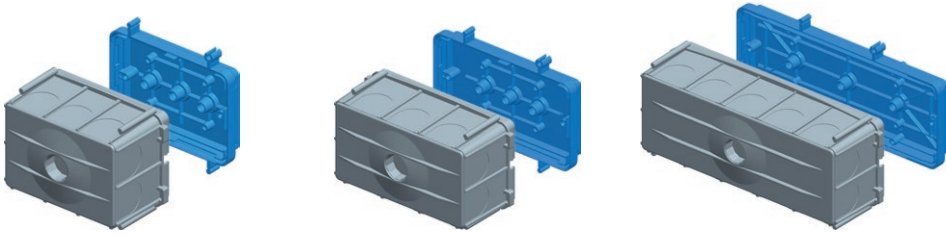

Montageanleitung/
assembly instructions

1

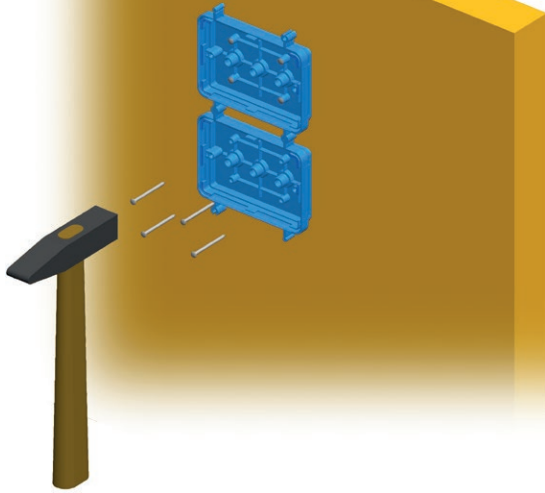

2

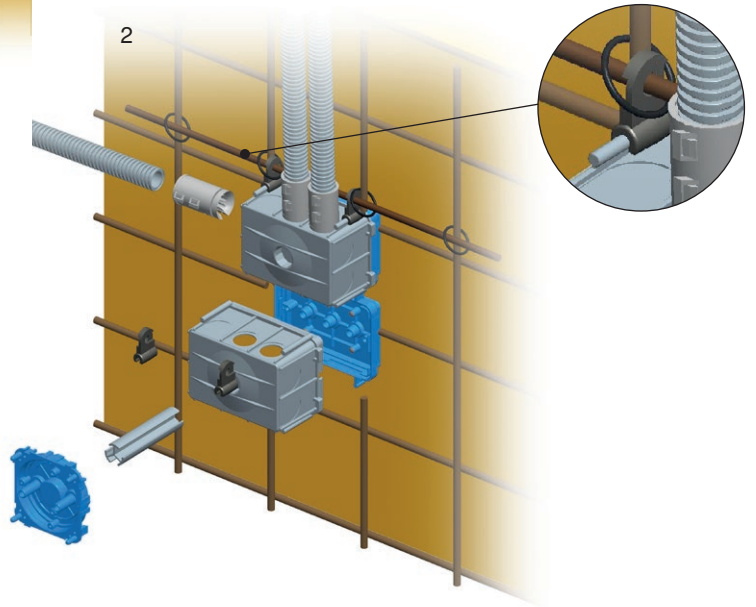

3

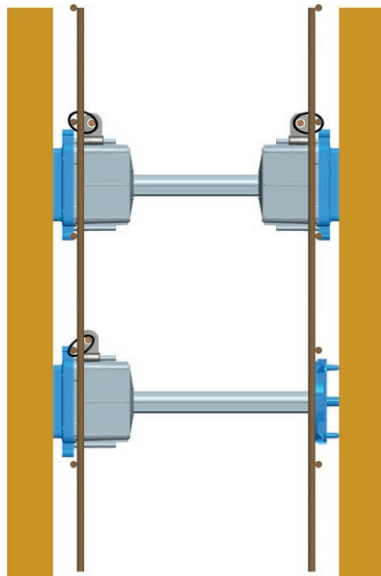

4

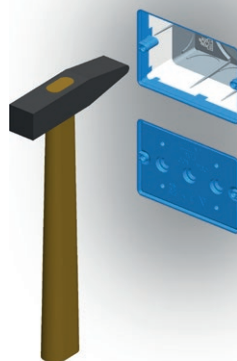

ABZWEIGDOSE RUND ZIEGELWAND DSM78



DW10

- Durchmesser $\varnothing 78$ mm, Tiefe 40mm
- 650°C, 500V~
- entspricht IEC 60670-1 und IEC 60670-22
- ohne Halogen

CONNECTION ROUND BOX BRICK DSM78

- $\varnothing 78$, depth 40mm
- 650°C, 500V~
- in accordance with IEC 60670-1 and IEC 60670-22
- halogen free

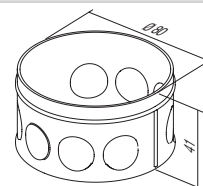

ABZWEIGDOSE RUND HOHLWAND SM78x45



HW10

- Durchmesser $\varnothing 78$ mm, Tiefe 45 mm
- Einbauloch $\varnothing 80$
- 850°C, 400V~
- entspricht IEC 60670-1 und IEC 60670-22
- Montage mit Krallen
- ohne Halogen

CONNECTION ROUND BOX HOLLOW WALL SM78x45

- $\varnothing 78$, depth 45mm
- cutting hole $\varnothing 80$
- 850°C, 400V~
- in accordance with IEC 60670-1 and IEC 60670-22
- mounting with claws
- halogen free

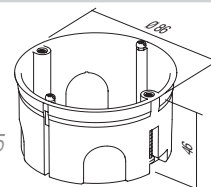

ABDECKUNG DEKORATIV SM78



DE23

- dekorative Abdeckung für Dosen $\varnothing 78$
- entspricht IEC 60670-1 und IEC 60670-22
- ohne Halogen

BOX COVER DECORATIVE SM78

- decorative cover for boxes $\varnothing 78$
- in accordance with IEC 60670-1 and IEC 60670-22
- halogen free

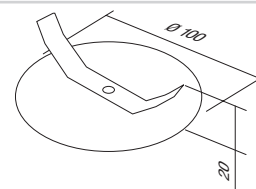

FEDERDECKEL 78

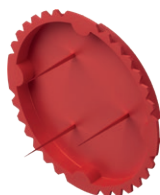

DE24

- Federdeckel für Dosen $\varnothing 78$
- entspricht IEC 60670-1 und IEC 60670-22
- ohne Halogen

BOX COVER PROTECTIVE 78

- protective cover for box $\varnothing 78$
- in accordance with IEC 60670-1 and IEC 60670-22
- halogen free

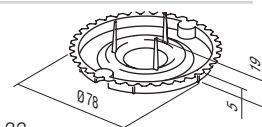

ABZWEIGKASTEN ZIEGELWAND SM105x105



HW20

- 105x105 mm, Tiefe 50 mm
- Einbauloch gemäß beigelegter Lehre
- 850°C, 400V~
- entspricht IEC 60670-1 und IEC 60670-22
- Montage mit Krallen
- ohne Halogen

CONNECTION SQUARE BOX BRICK SM105x105

- size 105x105mm, depth 50mm
- cutting hole according to attached template
- 850°C, 400V~
- in accordance with IEC 60670-1 and IEC 60670-22
- mounting with claws
- halogen free

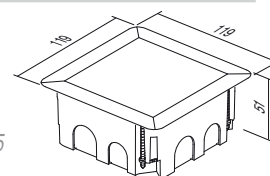

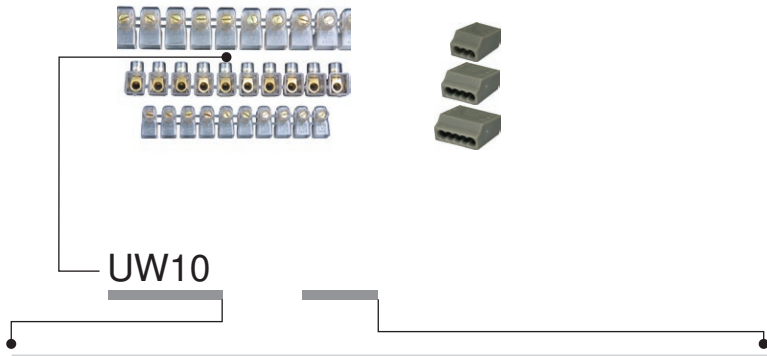

Typ type	Bezeichnung description	Technische Daten technical data	Größe size	Farbe colour
UW10	DOSENKLEMMLEISTEN GESCHLOSSEN 2x2.5mm ² 1 ROW TERMINAL BLOCKS		10P	<input checked="" type="checkbox"/> TS transparent transparent
UW11	DOSENKLEMMLEISTEN GESCHLOSSEN 2x4mm ² 1 ROW TERMINAL BLOCKS		10P	<input checked="" type="checkbox"/> CO farbig colour
UW12	DOSENKLEMMLEISTEN GESCHLOSSEN 2x6mm ² 1 ROW TERMINAL BLOCKS		10P	<input type="checkbox"/> WH weiß white
·	·	·	·	<input type="checkbox"/> GY grau grey

DOSENKLEMMLEISTEN GESCHLOSSEN



- 450V~; 2x2.5 mm² ÷ 2x6 mm²
- Thermoplast PC, transparent
- Klemmen in Leiste: 10

1 ROW TERMINAL BLOCKS CLOSED

- 450V~; 2x2.5mm² ÷ 2x6mm²
- thermoplast PC, transparent
- number of poles: 10

UW10TS	(NS12)	2x2.5mm ²	10P
UW11TS	(NS12)	2x4mm ²	10P
UW12TS	(NS12)	2x6mm ²	10P

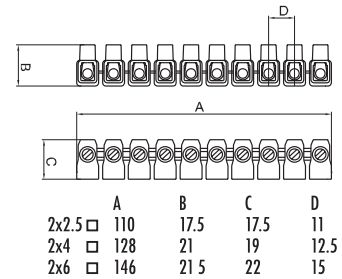

DOSENKLEMMLEISTEN

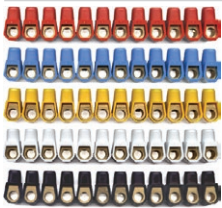

- 450V~; 2x2.5 mm² ÷ 2x6 mm²
- Thermoplast PA
- in verschiedenen Farben erhältlich
- Klemmen in Leiste: 12

1 ROW TERMINAL BLOCKS

- 450V~; 2x2.5mm² ÷ 2x6mm²
- thermoplast PA
- available in different colours
- number of poles: 12

UW15CO	(NS12)	2x2.5mm ²	12P
UW16CO	(NS12)	2x4mm ²	12P
UW17CO	(NS12)	2x6mm ²	12P

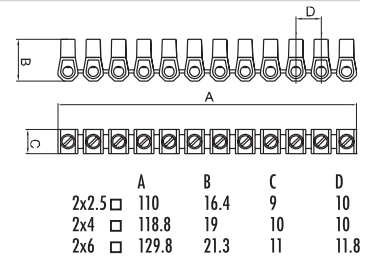

LÜSTER-KLEMMLEISTEN PP

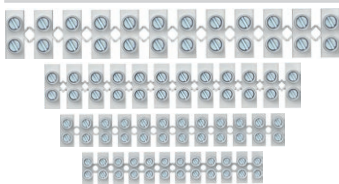

- 450 V~; 1 mm² ÷ 16 mm²
- Thermoplast Polypropylen PP, weiß
- für Temperaturen bis zu 80°C
- Klemmen in Leiste: 12

2 ROW TERMINAL BLOCKS PP

- 450V~; 1mm² ÷ 16mm²
- thermoplast polypropylene PP, white
- for temperatures up to 80°C
- number of poles: 12

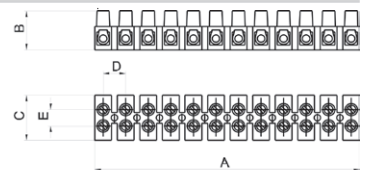

					A	B	C	D	E
UW29WHPP	1.0-4.0mm ²	24 A	450 V		94,9	13	16,6	8,1	6,4
UW30WHPP	1.5-6.0mm ²	32 A	450 V		116,5	14,9	18,9	10	7,3
UW31WHPP	2.5-10mm ²	41 A	450 V		133,8	17,3	23,4	11,5	10
UW32WHPP	4-16mm ²	76 A	450 V		174,5	20,7	25	15	11

LÜSTER-KLEMMLEISTEN PA

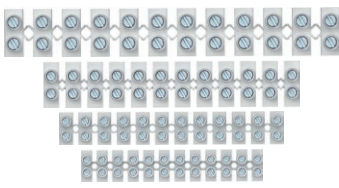

- 450 V~; 1 mm² ÷ 16 mm²
- Thermoplast Polyamid PA, weiß
- für Temperaturen bis zu 110°C
- Klemmen in Leiste: 12

2 ROW TERMINAL BLOCKS PA

- 450V~; 1mm² ÷ 16mm²
- thermoplast polyamide PA, white
- for temperatures up to 110°C
- number of poles: 12

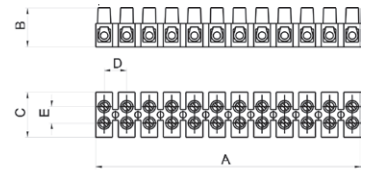

					A	B	C	D	E
UW25WHPA	1.0-4.0mm ²	24 A	450 V		93,6	13,4	16,2	8	6,4
UW26WHPA	1.5-6.0mm ²	32 A	450 V		117	15	18,6	10	7,3
UW27WHPA	2.5-10mm ²	41 A	450 V		132,8	17,3	22,2	11,5	10
UW28WHPA	4-16mm ²	76 A	450 V		173,9	20,8	25,2	15	11

STECKKLEMMEN



- 24A 450V~, Thermoplast PA, grau
- Klemmen in Leiste: 3÷8
- Steckklemmen 0,5÷1,5 mm², für harte Drähte
- entspricht EN 60998-1

PLUG-IN WIRE CONNECTORS

- 24A 450V~, thermoplast PA, grey
- number of poles: 3÷8
- plug-in contacts 0.5÷1.5mm², for rigide wires
- in accordance with EN 60998-1

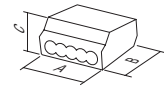

					A	B	C
UW40GY	PC153	1.5mm ²	3P	3P	12	18	9
UW41GY	PC155	1.5mm ²	5P	5P	17	18	9
UW42GY	PC158	1.5mm ²	8P	8P	26	18	9

STECKKLEMMEN



- 24A 450V~, Thermoplast PA, grau
- Klemmen in Leiste: 3÷5
- Steckklemmen 1,5÷2,5 mm², für harte Drähte
- entspricht EN 60998-1

PLUG-IN WIRE CONNECTORS

- 24A 450V~, thermoplast PA, grey
- number of poles: 3÷5
- plug-in contacts 1.5÷2.5mm², for rigide wires
- in accordance with EN 60998-1

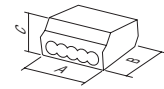

					A	B	C
UW45GY	PC253	2.5mm ²	3P	3P	14	19	9
UW46GY	PC254	2.5mm ²	4P	4P	17	19	9
UW47GY	PC255	2.5mm ²	5P	5P	21	19	9

STECKKLEMMEN



- 24A 450V~, Thermoplast PA, grau
- Klemmen in Leiste: 2 (harter Draht) + 1 (weicher Draht)
- Steckklemmen 1,5÷2,5 mm²
- entspricht EN 60998-1

PLUG-IN WIRE CONNECTOR

- 24A 450V~, thermoplast PA, grey
- number of poles: 2 (rigide wire)+1 (soft wire)
- plug-in contacts 1.5÷2.5mm²
- in accordance with EN 60998-1

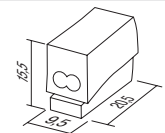

UW50WH	PC302	2.5mm ²	2/1P				
--------	-------	--------------------	------	--	--	--	--



MODUL
PURE

132

133

135

140

VERTRIEB

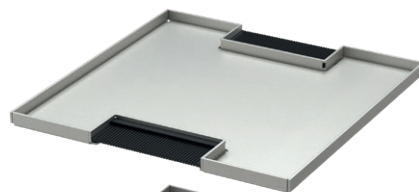

TEM



A U F P U T Z G E H Ä U S E C U B O I P 2 0 A C

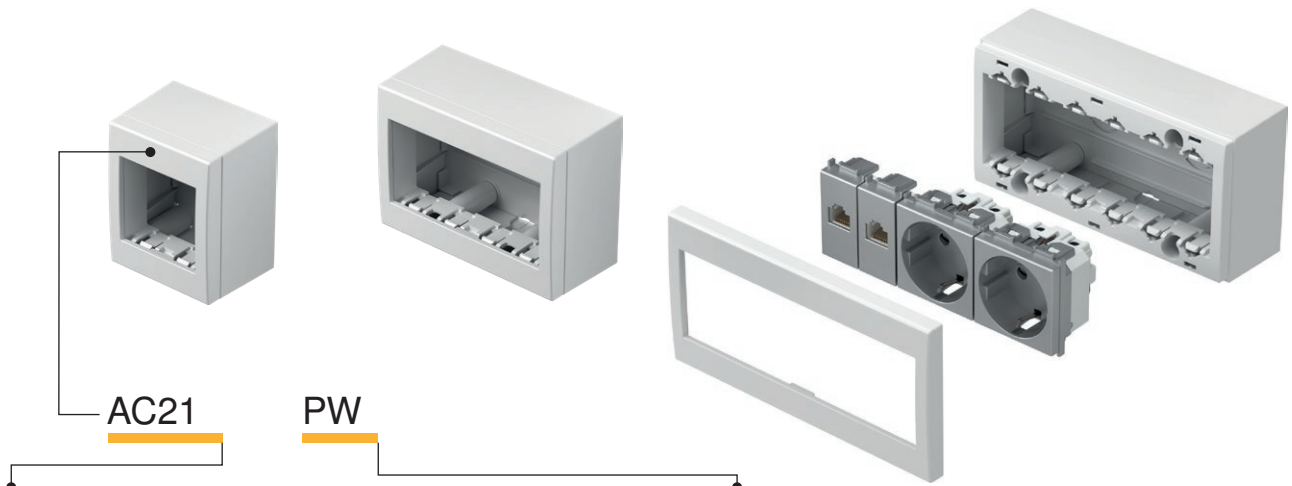

Typ type	Bezeichnung description	Technische Daten technical data	Größe size	Farbe colour
AC11	AUFPUTZGEHÄUSE NO CUBO MIT BODEN SURFACE MOUNT BOX WITH BACK SIDE COVER	IP20	1M	<input type="checkbox"/> PW weiß-glanz polar white <input type="checkbox"/> ES silber-matt elox silver <input type="checkbox"/> IW beige-glanz ivory white
AC21	AUFPUTZGEHÄUSE NO CUBO MIT BODEN SURFACE MOUNT BOX WITH BACK SIDE COVER	IP20	2M	<input type="checkbox"/> PW weiß-glanz polar white <input type="checkbox"/> ES silber-matt elox silver <input type="checkbox"/> IW beige-glanz ivory white
AC41	AUFPUTZGEHÄUSE NO CUBO MIT BODEN SURFACE MOUNT BOX WITH BACK SIDE COVER	IP20	4M	<input type="checkbox"/> PW weiß-glanz polar white <input type="checkbox"/> ES silber-matt elox silver <input type="checkbox"/> IW beige-glanz ivory white

AUFPUTZGEHÄUSE NO CUBO MIT BODEN IP20 1M



- AC11PW
- AC11ES
- AC11IW

- Aufputzgehäuse IP20 1M
- Aufputzbefestigung der Elemente
- geeignet für Schalter SM
- entspricht EN 60669-1

BOX NO CUBO WITH BACK SIDE COVER IP20 1M
 - box IP20 1M
 - for surface mounting of elements
 - suitable to SM switches
 - in accordance with EN 60669-1



AUFPUTZGEHÄUSE NO CUBO MIT BODEN IP20 2M



- AC21PW
- AC21ES
- AC21IW

- Aufputzgehäuse IP20 2M
- Aufputzbefestigung der Elemente
- entspricht EN 60669-1, EN60884-1

BOX NO CUBO WITH BACK SIDE COVER IP20 2M
 - box IP20 2M
 - for surface mounting of elements
 - in accordance with EN 60669-1, EN60884-1



AUFPUTZGEHÄUSE NO CUBO MIT BODEN IP20 4M



- AC41PW
- AC41ES
- AC41IW

- Aufputzgehäuse IP20 4M
- Aufputzbefestigung der Elemente
- entspricht EN 60669-1, EN60884-1

BOX NO CUBO WITH BACK SIDE COVER IP20 4M
 - box IP20 4M
 - for surface mounting of elements
 - in accordance with EN 60669-1, EN60884-1



AUFPUTZGEHÄUSE NO CUBO MIT BODEN IP20 6M



- AC61PW
- AC61ES
- AC61IW

- Aufputzgehäuse IP20 6M
- Aufputzbefestigung der Elemente
- entspricht EN 60669-1, EN60884-1

BOX NO CUBO WITH BACK SIDE COVER IP20 6M
 - box IP20 6M
 - for surface mounting of elements
 - in accordance with EN 60669-1, EN60884-1

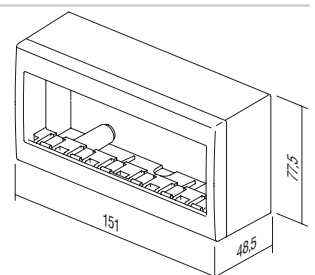
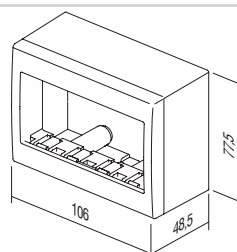
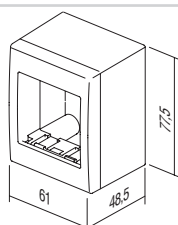
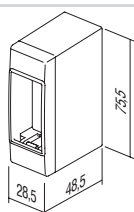

B O X E S C U B O I P 5 5 A Q



Typ type	Bezeichnung description	Technische Daten technical data	Größe size	Farbe colour
AQ20	AUFPUTZGEHÄUSE NO CUBO OUTDOOR SURFACE MOUNT BOX	IP55	2M	<input type="checkbox"/> PW weiß-glanz polar white
AQ22	AUFPUTZGEHÄUSE NO CUBO OUTDOOR SURFACE MOUNT BOX	IP55	2x2M	<input checked="" type="checkbox"/> GY grau grey
AQ30	AUFPUTZGEHÄUSE NO CUBO OUTDOOR SURFACE MOUNT BOX	IP55	3M	
AQ31	AUFPUTZGEHÄUSE PO CUBO OUTDOOR SURFACE MOUNT BOX	IP55	3M	

AUFPUTZGEHÄUSE NO CUBO IP55 2M



- AQ20PW
- AQ20GY

- Aufputzgehäuse IP55 2M
- Aufputzbefestigung der Elemente
- IP55 geeignet für feuchte Räume
- entspricht CEI 23-48, EN 60670

BOX NO CUBO IP55 2M
 - box IP55 2M
 - for surface mounting
 - IP55 for usage in humid areas
 - in accordance with CEI 23-48, EN 60670



AUFPUTZGEHÄUSE NO CUBO IP55 2x2M



- AQ22PW
- AQ22GY

- Aufputzgehäuse IP55 2x2M
- Aufputzbefestigung der Elemente
- IP55 geeignet für feuchte Räume
- entspricht CEI 23-48, EN 60670

BOX NO CUBO IP55 2x2M
 - box IP55 2x2M
 - for surface mounting
 - IP55 for usage in humid areas
 - in accordance with CEI 23-48, EN 60670



AUFPUTZGEHÄUSE NO CUBO IP55 3M



- AQ30PW
- AQ30GY

- Aufputzgehäuse IP55 3M
- Aufputzbefestigung der Elemente
- IP55 geeignet für feuchte Räume
- entspricht CEI 23-48, EN 60670

BOX NO CUBO IP55 3M
 - box IP55 3M
 - for surface mounting
 - IP55 for usage in humid areas
 - in accordance with CEI 23-48, EN 60670





- AQ21PW
- AQ21AT

UNTERPUTZGEHÄUSE PO CUBO IP55 2M

- Unterputzgehäuse IP55 2M
- kann mit allen Funktionselementen Modul kombiniert werden
- Unterputzbefestigung der Elemente
- IP55 geeignet für feuchte Räume
- entspricht CEI 23-48, EN 60670

BOX PO CUBO IP55 2M

- box IP55 2M
- can be combined with all Modul functional elements
- for flush mounting
- IP55 for usage in humid areas
- in accordance with CEI 23-48, EN 60670



- AQ31PW
- AQ31GY

UNTERPUTZGEHÄUSE PO CUBO IP55 3M

- Aufputzgehäuse IP55 3M
- Unterputzbefestigung der Elemente
- IP55 geeignet für feuchte Räume
- entspricht CEI 23-48, EN 60670

BOX PO CUBO IP55 3M

- box IP55 3M
- for flush mounting
- IP55 for usage in humid areas
- in accordance with CEI 23-48, EN 60670

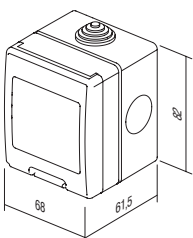

AQ20

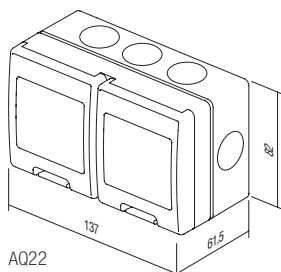

AQ22

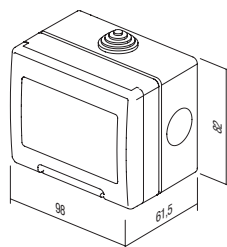

AQ30

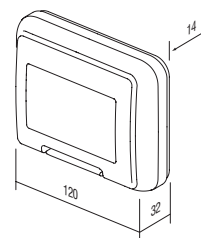

AQ31

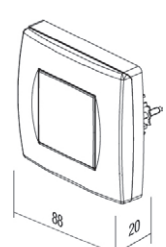

AQ21

T R U N K I N G S Y S T E M A L U M I N I U M

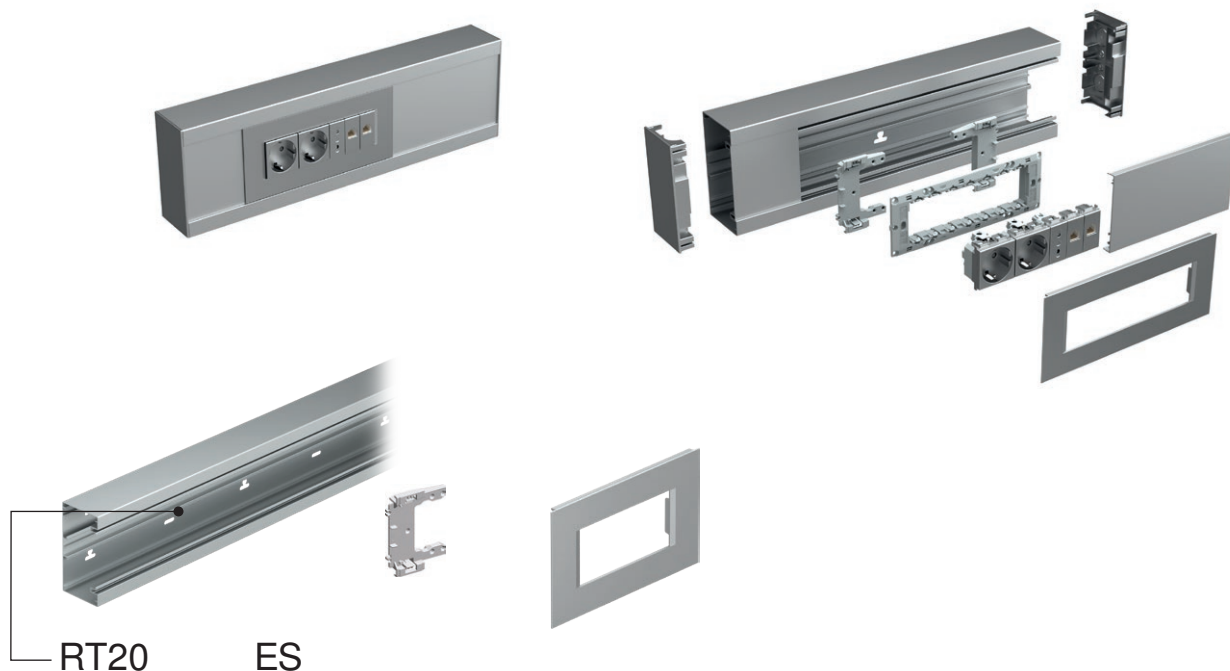

Typ type	Bezeichnung description	Größe size	Farbe colour
RT10	ADAPTER MA 92 ADAPTER MA 92	/	■ ES silber-matt elox silver-mat
RT12	RAHMEN MA 92 COVER PLATE MA 92	2/3M	□ PW weiß-matt (RAL 9016) white-mat
RT14	RAHMEN MA 92 COVER PLATE MA 92	4M	
⋮	⋮	⋮	

ADAPTER MA 92



RT10

- Adapter zur Befestigung der Montageträger 2/3M, 4M- bzw. 7M-Modul auf Kanal MA ohne Dose
- 2 Adapter je Träger
- entspricht EN 50085-1

ADAPTER MA 92

- adapter for fixing mounting frames 2/3M, 4M or 7M on MA trunking without box
- each mounting frame needs two adapters
- in accordance with EN 50085-1

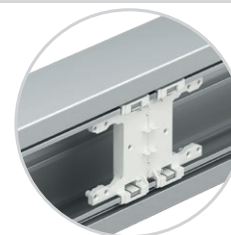

RAHMEN MA 92 2/3M



- RT12ES
- RT12PW

- dekorativer Rahmen MA 2/3M
- entspricht EN 50085-1

COVER PLATE MA 92 2/3M

- decorative cover plate MA 2/3M
- in accordance with EN 50085-1

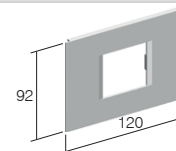

RAHMEN MA 92 4M



- RT14ES
- RT14PW

- dekorativer Rahmen MA 4M
- entspricht EN 50085-1

COVER PLATE MA 92 4M

- decorative cover plate MA 4M
- in accordance with EN 50085-1

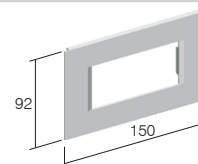

RAHMEN MA 92 7M



- RT17ES
- RT17PW

- dekorativer Rahmen MA 7M
- entspricht EN 50085-1

COVER PLATE MA 92 7M

- decorative cover plate MA 7M
- in accordance with EN 50085-1

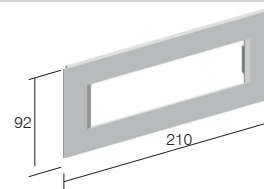

KANALUNTERTEIL MA 130x65



- RT20ES
- RT20PW

- Unterteil für Brüstungskanal aus Aluminium
- Höhe 130 mm, Länge 2m
- am Kanalboden befindet sich eine 35-mm-DIN-Erdungsschiene
- entspricht EN 50085-1

TRUNKING BASE MA 130x65

- trunking base from extruded aluminium
- height 130mm, length 2m
- DIN - rail 35mm shape on bottom
- in accordance with EN 50085-1

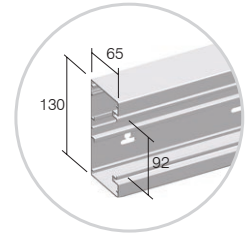

KANALUNTERTEIL MA 165x65



- RT21ES
- RT21PW

- Unterteil für Brüstungskanal aus Aluminium
- Höhe 165mm, Länge 2m
- am Kanalboden befindet sich eine 35-mm-DIN-Erdungsschiene
- entspricht EN 50085-1

TRUNKING BASE MA 165x65

- trunking base from extruded aluminium
- height 165mm, length 2m
- DIN - rail 35mm shape on bottom
- in accordance with EN 50085-1

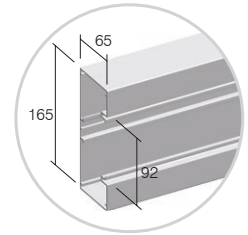

FRONTABDECKUNG MA 92

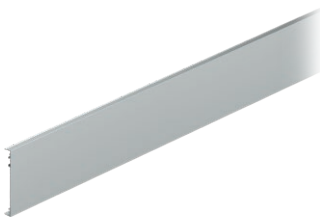

- RT25ES
- RT25PW

- Aluminiumdeckel zur Abdeckung des Unterteils
- Höhe 92mm, Länge 2m
- entspricht EN 50085-1

FRONT COVER MA 92

- front cover from extruded aluminium
- height 92mm, length 2m
- in accordance with EN 50085-1

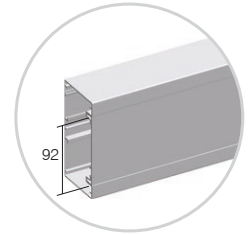

TRENNWAND MA 43



RT30

- Kanaltrennwand aus Polymer
- Tiefe 43 mm, Länge 2 m
- entspricht EN 50085-1

CABLE SHELF MA 43

- cable shelf from extruded polymer
- depth 43mm, length 2m
- in accordance with EN 50085-1

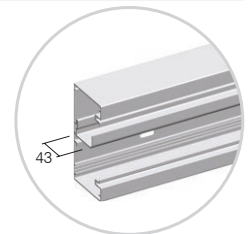

TRENNWAND MA 43 AL



RT31

- Kanaltrennwand aus Aluminium
- Tiefe 43 mm, Länge 2 m
- entspricht EN 50085-1

CABLE SHELF MA 43 AL

- cable shelf from extruded aluminium
- depth 43mm, length 2m
- in accordance with EN 50085-1

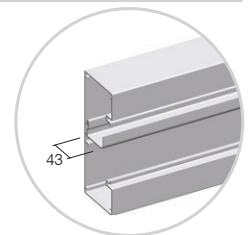

TRENNWAND MA 43 AL DOPPELT



RT32

- doppelte Kanaltrennwand aus Aluminium
- Tiefe 43 mm, Länge 2 m
- entspricht EN 50085-1

CABLE SHELF MA 43 AL DOUBLE

- double cable shelf from extruded aluminium
- depth 43mm, length 2m
- in accordance with EN 50085-1

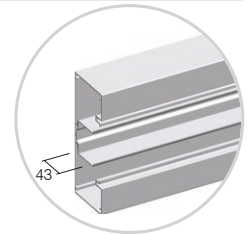

T R U N K I N G S Y S T E M A L U M I N I U M

	<input checked="" type="checkbox"/> RT35ES <input type="checkbox"/> RT35PW	<p>ENDSTÜCK MA 130x65</p> <ul style="list-style-type: none"> - Kanalendstück aus Polymer - Höhe 130mm - entspricht EN 50085-1 <p><i>STOP END MA 130x65</i></p> <ul style="list-style-type: none"> - stop end element from polymer - height 130mm - in accordance with EN 50085-1 	
	<input checked="" type="checkbox"/> RT36ES <input type="checkbox"/> RT36PW	<p>ENDSTÜCK MA 165x65</p> <ul style="list-style-type: none"> - Kanalendstück aus Metall - Höhe 165mm - entspricht EN 50085-1 <p><i>STOP END MA 165x65</i></p> <ul style="list-style-type: none"> - stop end element from metal - height 165mm - in accordance with EN 50085-1 	
	RT38	<p>VERBINDUNGSSTÜCK MA 65</p> <ul style="list-style-type: none"> - Kanalverbindungsstück aus Polymer - inkl. 2 Verbindungsstücke und Schrauben - entspricht EN 50085-1 <p><i>SET JOINING PIECE MA 65</i></p> <ul style="list-style-type: none"> - joining piece from polymer - set contains two pieces and screws - in accordance with EN 50085-1 	
	<input checked="" type="checkbox"/> RT40ES <input type="checkbox"/> RT40PW	<p>UNIVERSALECK MA 130x65</p> <ul style="list-style-type: none"> - Universal-Eckelement für Innen- und Außenecken - Höhe 130mm - entspricht EN 50085-1 <p><i>UNIVERSAL CORNER MA 130x65</i></p> <ul style="list-style-type: none"> - universal corner element - height 130mm - in accordance with EN 50085-1 	
	<input checked="" type="checkbox"/> RT41ES <input type="checkbox"/> RT41PW	<p>UNIVERSALECK MA 165x65</p> <ul style="list-style-type: none"> - Universal-Eckelement für Innen- und Außenecken - Höhe 165mm - entspricht EN 50085-1 <p><i>UNIVERSAL CORNER MA 165x65</i></p> <ul style="list-style-type: none"> - universal corner element - height 165mm - in accordance with EN 50085-1 	
	RT42	<p>ERDUNGSKLEMME MA 2x A6.3</p> <ul style="list-style-type: none"> - Klemme zur Erdung von Kanalunterteil und -Deckel - entspricht EN 50085-1 <p><i>EARTHING PIECE MA 2x A6.3</i></p> <ul style="list-style-type: none"> - earthing piece for earthing of trunking base and front cover - in accordance with EN 50085-1 	

FLACHWINKEL MA 130x65

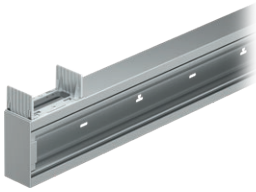

- RT43ES
- RT43PW

- Universal-Flachwinkel aus Aluminium für L-Verbindungen
- Höhe 130 mm, Länge 400mm
- entspricht EN 50085-1

L-BEND MA 130x65

- universal L bend element from aluminium
- height 130mm, length 400mm
- in accordance with EN 50085-1

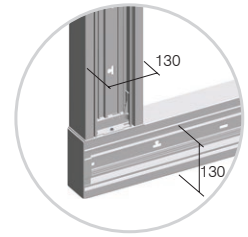

FLACHWINKEL MA 165x65



- RT44ES
- RT44PW

- Universal-Flachwinkel aus Aluminium für L-Verbindungen
- Höhe 165mm, Länge 400mm
- Verbindung auf MA 130x65
- entspricht EN 50085-1

L-BEND MA 165x65

- universal L bend element from aluminium
- height 165mm, length 400mm
- connection on MA 130x65
- in accordance with EN 50085-1

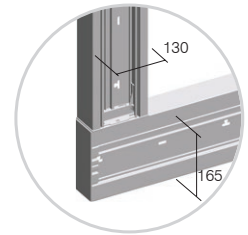

T-STÜCK MA 130x65



- RT45ES
- RT45PW

- Universal-T-Stück aus Aluminium für T-Verbindungen
- Höhe 130 mm, Länge 400mm
- entspricht EN 50085-1

T-BEND MA 130x65

- universal T bend element from aluminium
- height 130mm, length 400mm
- in accordance with EN 50085-1

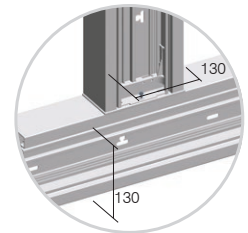

T-STÜCK MA 165x65



- RT46ES
- RT46PW

- Universal-T-Stück aus Aluminium für T-Verbindungen
- Höhe 165mm, Länge 400mm
- Verbindung auf MA 130x65
- entspricht EN 50085-1

T-BEND MA 165x65

- universal T bend element from aluminium
- height 165mm, length 400mm
- connection on MA 130x65
- in accordance with EN 50085-1

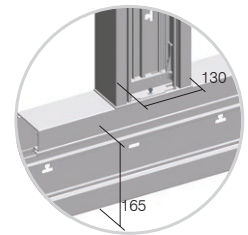

Modul MA basiert auf der Möglichkeit, 2M-, 4M- oder 7M-Elemente zu kombinieren.

MA trunking is based on modular system making 2M, 4M or 7M combinations of elements

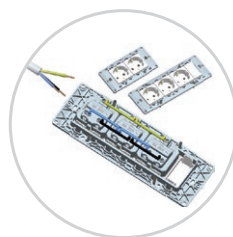

Modul MA beinhaltet spezielle Elemente für eine schnelle Montage.

In Modul we provide special elements for quick installation

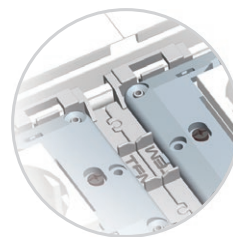

Mit den Adaptern MA ist eine exakte Positionierung auf den Kanalrand möglich.

With Adapter MA exact positioning without extra effort is provided

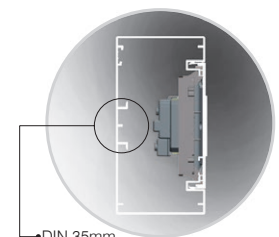

Ohne Montage-Box bedeutet mehr Platz für Kabel, DIN Leiste nach EN-60715.

Mounted without box means more space for cables, DIN rail base shape EN-60715

T R U N K I N G S Y S T E M A L U M I N I U M



BEFESTIGUNGSPLATTE EINFACH MA 130x65



- RT50ES
- RT50PW

- zur Befestigung der Servicesäule MA 130 am Boden und/oder auf der Decke
- entspricht EN 50085-1

FIXING PLATE MA SINGLE 130x65

- fixing plate for fixing trunking base MA130 on the floor and/or on the ceiling
- in accordance with EN 50085-1



- RT51ES
- RT51PW

BEFESTIGUNGSPLATTE DOPPELT MA 130x65

- zur Befestigung von zwei Servicesäulen MA 130 am Boden und/oder auf der Decke
- entspricht EN 50085-1

FIXING PLATE MA DOUBLE 130x65

- fixing plate for fixing two trunking bases MA130 on the floor and/or on the ceiling
- in accordance with EN 50085-1



- RT52ES
- RT52PW

SERVICESÄULE MA 130x65x500

- Installationssäule MA
- Höhe 500 mm
- inkl. Montageträger 7M
- entspricht EN 50085-1

SERVICE POST MA 130x65x500

- service post MA
- height 500mm
- mounting frame 7M included
- in accordance with EN 50085-1



- RT53ES
- RT53PW

SERVICESÄULE DOPPELT 130x130x500

- Installationssäule doppelt MA
- Höhe 500 mm
- inkl. zwei Montageträger 7M
- entspricht EN 50085-1

SERVICE POST MA DOUBLE 130x130x500

- service post MA double
- height 500mm
- mounting frames 7M included
- in accordance with EN 50085-1

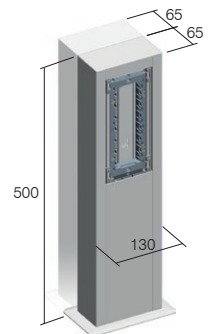

Kabelquerschnitt / Cable intersection mm ²	Kabelkapazität / Cable cross-section (mm ²)				
	1 Kabel / 1 wire	2 Kabel / 2 wires	3 Kabel / 3 wires	4 Kabel / 4 wires	5 Kabel / 5 wires
1,5	44	111	121	144	169
2,5	49	133	157	169	211
4	58	169	183	211	256
6	68	196	225	256	307

Kanal / Trunk	Kanalkapazität / Trunk capacity			
	MA 130x65 leer / empty	MA 130x65 mit Modul-Ausrüstung / with Modul switches and sockets	MA 165x65 leer / empty	MA 130x65 mit Modul-Ausrüstung / with Modul switches and sockets
Kapazität capacity max ø	7600 mm ² 54 mm	5500 mm ² 2x42 mm	9900 mm ² 54 mm	7800 mm ² 2x42 mm

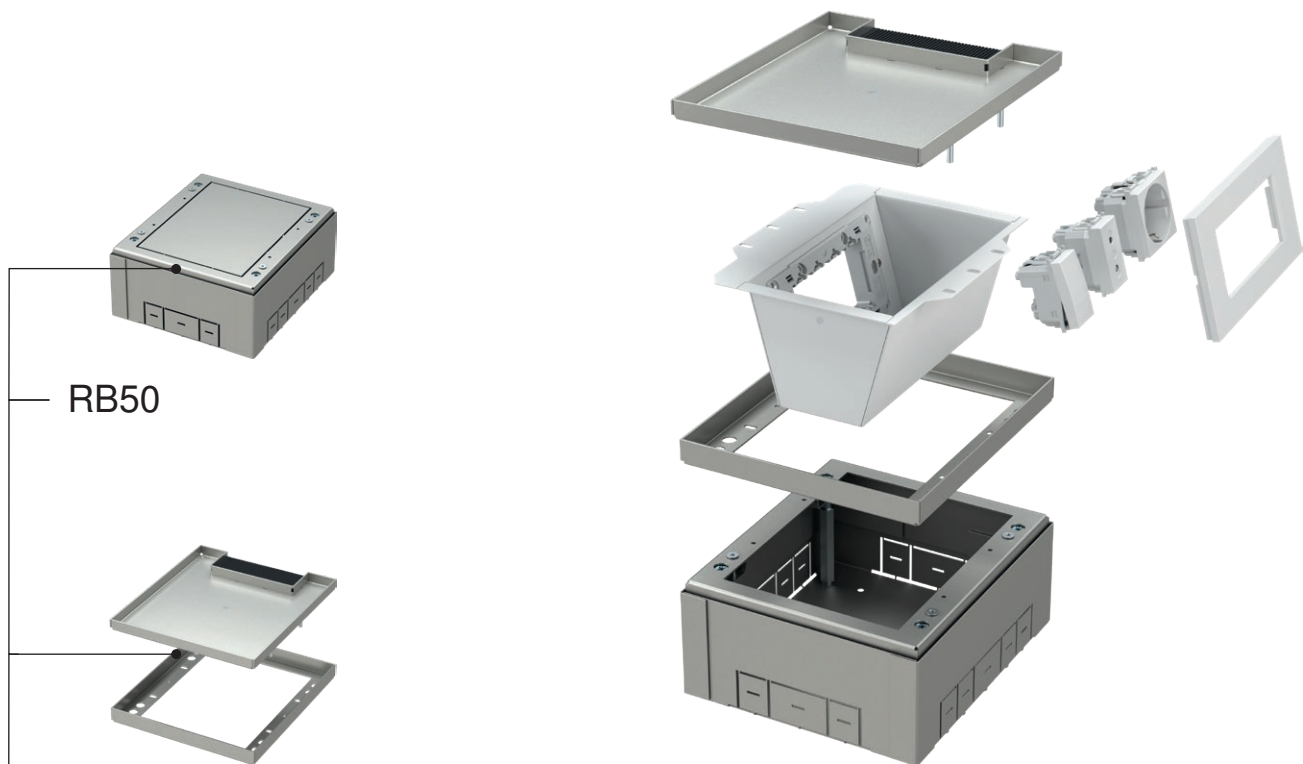

Typ type	Bezeichnung description	Technische Daten technical data
RB50	UNTERSATZ FÜR BODENDOSEN FLOOR BOX BASE	4M
RB65S1	DECKEL FÜR BODENDOSEN FLOOR DISTRIBUTION BOX COVER	4M
RB60	EINSATZ FÜR BODENDOSEN INSERT FOR FLOOR DISTIRBUTION BOX	4M
·	·	·
·	·	·

	RB65S1	RB66S1	RB67S2	RB68S2
X	177	178	265	516,5
Y	200,5	265	265	265
Z	17,5	17,5	17,5	17,5

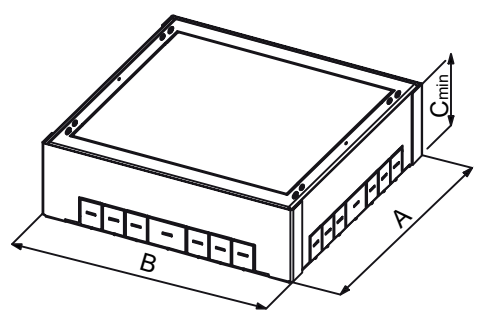
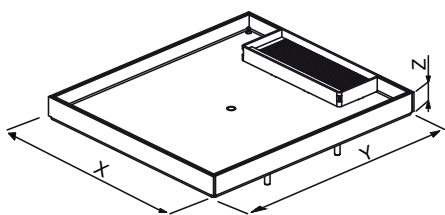

	RB50	RB51	RB52	RB53
A	208,5	273	273	273
B	182	182,5	269,5	521
C	83	83	83	83

F L O O R B O X E S M T

UNTERSATZ FÜR BODENDOSEN 4M



RB50

- Untersatz 4M
- Metall, verzinkt
- für Montage in einem Boden oder Doppelboden
- Einbauloch 208,5x182 mm, Tiefe min. 83 mm
- Einstellhöhe 83-128 mm
- entspricht EN 5005-1 und EN 50085-2-2

FLOOR BOX BASE 4M

- floor box base 4M
- metal, galvanized
- for installation in a floor or double floor
- mounting dimensions 208.5x182mm, min. depth 83mm
- adjustable height 83-128mm
- in accordance with EN 5005-1 and EN 50085-2-2

EINSATZ FÜR BODENDOSEN 4M



RB60

- Einsatz für Bodendosen 4M
- Metall, weiß RAL 9006
- inkl. Montageträger MODUL 4M
- entspricht EN 5005-1 und EN 50085-2-2

INSERT FOR FLOOR DISTRIBUTION BOX 4M

- insert for floor box 4M
- metal, colour white RAL 9006
- mounting frame MODUL 4M included
- in accordance with EN 5005-1 and EN 50085-2-2

DECKEL FÜR BODENDOSEN 4M



RB65S1

- Deckel für Bodendosen 4M
- Metall, verzinkt
- Einbauloch 200,5x177 mm, Tiefe 17,5 mm
- Bodendicke bis 11,5 mm
- entspricht EN 5005-1 und EN 50085-2-2

FLOOR DISTRIBUTION BOX COVER 4M

- floor box cover 4M
- metal, galvanized
- mounting dimensions 200.5x177mm, depth 17.5mm
- floor thickness up to 11.5mm
- in accordance with EN 5005-1 and EN 50085-2-2

UNTERSATZ FÜR BODENDOSEN 7M



RB51

- Untersatz 7M
- Metall, verzinkt
- für Montage in einem Boden oder Doppelboden
- Einbauloch 273x182,5 mm, Tiefe min. 83 mm
- Einstellhöhe 83-128 mm
- entspricht EN 5005-1 und EN 50085-2-2

FLOOR BOX BASE 7M

- floor box base 7M
- metal, galvanized
- for installation in a floor or double floor
- mounting dimensions 273x182.5mm, min. depth 83mm
- adjustable height 83-128mm
- in accordance with EN 5005-1 and EN 50085-2-2

EINSATZ FÜR BODENDOSEN 7M



RB61

- Einsatz für Bodendosen 7M
- Metall, weiß RAL 9006
- inkl. Montageträger MODUL 7M
- entspricht EN 5005-1 und EN 50085-2-2

INSERT FOR FLOOR DISTRIBUTION BOX 7M

- insert for floor box 7M
- metal, colour white RAL 9006
- mounting frame MODUL 7M included
- in accordance with EN 5005-1 and EN 50085-2-2

DECKEL FÜR BODENDOSEN 7M

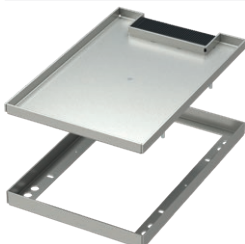

RB66S1

- Deckel für Bodendosen 7M
- Metall, verzinkt
- Einbauloch 265x178 mm, Tiefe 17,5 mm
- Bodendicke bis 11,5 mm
- entspricht EN 5005-1 und EN 50085-2-2

FLOOR DISTRIBUTION BOX COVER 7M

- floor box cover 7M
- metal, galvanized
- mounting dimensions 265x178mm, depth 17.5mm
- floor thickness up to 11.5mm
- in accordance with EN 5005-1 and EN 50085-2-2

UNTERSATZ FÜR BODENDOSEN 2X7M

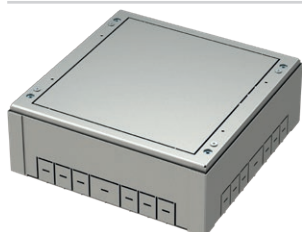

RB52

- Untersatz 2x7M
- Metall, verzinkt
- für Montage in einem Boden oder Doppelboden
- Einbauloch 273x269,5 mm, Tiefe min. 83 mm
- Einstellhöhe 83-128 mm
- entspricht EN 5005-1 und EN 50085-2-2

FLOOR BOX BASE 2X7M

- floor box base 2x7M
- metal, galvanized
- for installation in a floor or double floor
- mounting dimensions 273x269.5mm, min. depth 83mm
- adjustable height 83-128mm
- in accordance with EN 5005-1 and EN 50085-2-2

EINSATZ FÜR BODENDOSEN 2X7M



RB62

- Einsatz für Bodendosen 2x7M
- Metall, weiß RAL 9006
- inkl. Montageträger MODUL 7Mx2
- entspricht EN 5005-1 und EN 50085-2-2

INSERT FOR FLOOR DISTRIBUTION BOX 2X7M

- insert for floor box 2x7M
- metal, colour white RAL 9006
- mounting frames MODUL 2x7M included
- in accordance with EN 5005-1 and EN 50085-2-2

DECKEL FÜR BODENDOSEN 2X7M



RB67S2

- Deckel für Bodendosen 2x7M
- Metall, verzinkt
- Einbauloch 265x265 mm, Tiefe 17,5 mm
- Bodendicke bis 11,5 mm
- entspricht EN 5005-1 und EN 50085-2-2

FLOOR DISTRIBUTION BOX COVER 2X7M

- floor box cover 2x7M
- metal, galvanized
- mounting dimensions 265x265mm, depth 17.5mm
- floor thickness up to 11.5mm
- in accordance with EN 5005-1 and EN 50085-2-2

UNTERSATZ FÜR BODENDOSEN 4X7M

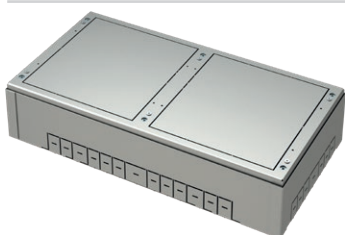

RB53

- Untersatz 4x7M
- Metall, verzinkt
- für Montage in einem Boden oder Doppelboden
- Einbauloch 273x521 mm, Tiefe min. 83 mm
- Einstellhöhe 83-128 mm
- entspricht EN 5005-1 und EN 50085-2-2

FLOOR BOX BASE 4X7M

- floor box base 4x7M
- metal, galvanized
- for installation in a floor or double floor
- mounting dimensions 273x521mm, min. depth 83mm
- adjustable height 83-128mm
- in accordance with EN 5005-1 and EN 50085-2-2

EINSATZ FÜR BODENDOSEN 2X7M



RB62

- Einsatz für Bodendosen 2x7M
- Metall, weiß RAL 9006
- inkl. Montageträger MODUL 7Mx2
- entspricht EN 5005-1 und EN 50085-2-2

INSERT FOR FLOOR DISTRIBUTION BOX 2X7M

- insert for floor box 2x7M
- metal, colour white RAL 9006
- mounting frames MODUL 2x7M included
- in accordance with EN 5005-1 and EN 50085-2-2

DECKEL FÜR BODENDOSEN 4X7M



RB68S2

- Deckel für Bodendosen 4x7M
- Metall, verzinkt
- Einbauloch 265x516,5 mm, Tiefe 17,5 mm
- Bodendicke bis 11,5 mm
- entspricht EN 5005-1 und EN 50085-2-2

FLOOR DISTRIBUTION BOX COVER 4X7M

- floor box cover 4x7M
- metal, galvanized
- mounting dimensions 265x516.5mm, depth 17.5mm
- floor thickness up to 11.5mm
- in accordance with EN 5005-1 and EN 50085-2-2



Typ type	Bezeichnung description	Technische Daten technical data
RB55S1	BODENDOSE FÜR DOPPELBODEN MIT DECKEL FLOOR BOX WITH COVER FOR DOUBLE FLOORS	4M
RB60	EINSATZ FÜR BODENDOSEN INSERT FOR FLOOR DISTRIBUTION BOX	4M
⋮	⋮	⋮
⋮	⋮	⋮

	RB55S1	RB56S1	RB57S2	RB58S2
A	200,5	265	265	265
B	177	178	265	516,5
C	100	100	100	100

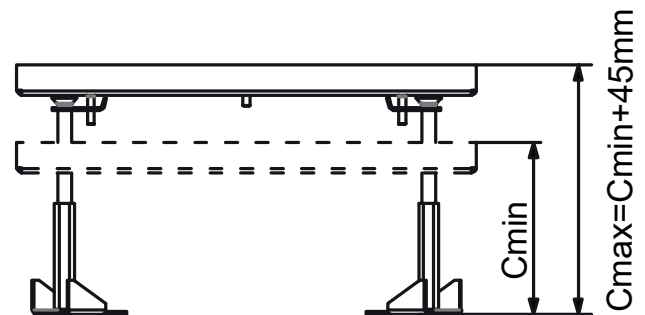
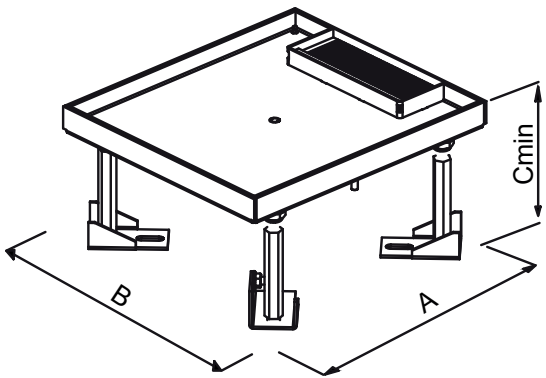

BODENDOSE FÜR DOPPELBODEN MIT DECKEL 4M



RB55S1

- Bodendose für Doppelboden 4M
- Metall, verzinkt
- Einbauloch 200,5x177 mm, Tiefe min. 100 mm
- Einstellhöhe 100-145 mm
- Bodendicke bis 11,5 mm
- entspricht EN 5005-1 und EN 50085-2-2

FLOOR BOX WITH COVER FOR DOUBLE FLOORS 4M

- floor box base 4M
- metal, galvanized
- mounting dimensions 200.5x177mm, min. depth 100mm
- adjustable height 100-145mm
- floor thickness up to 11.5mm
- in accordance with EN 5005-1 and EN 50085-2-2

EINSATZ FÜR BODENDOSEN 4M



RB60

- Einsatz für Bodendosen 4M
- Metall, weiß RAL 9006
- inkl. Montageträger MODUL 4M
- entspricht EN 5005-1 und EN 50085-2-2

INSERT FOR FLOOR DISTRIBUTION BOX 4M

- insert for floor box 4M
- metal, colour white RAL 9006
- mounting frame MODUL 4M included
- in accordance with EN 5005-1 and EN 50085-2-2

BODENDOSE FÜR DOPPELBODEN MIT DECKEL 7M



RB56S1

- Bodendose für Doppelboden 7M
- Metall, verzinkt
- Einbauloch 265x178 mm, Tiefe min. 100 mm
- Einstellhöhe 100-145 mm
- Bodendicke bis 11,5 mm
- entspricht EN 5005-1 und EN 50085-2-2

FLOOR BOX WITH COVER FOR DOUBLE FLOORS 7M

- floor box base 7M
- metal, galvanized
- mounting dimensions 265x178mm, min. depth 100mm
- adjustable height 100-145mm
- floor thickness up to 11.5mm
- in accordance with EN 5005-1 and EN 50085-2-2

EINSATZ FÜR BODENDOSEN 7M



RB61

- Einsatz für Bodendosen 7M
- Metall, weiß RAL 9006
- inkl. Montageträger MODUL 7M
- entspricht EN 5005-1 und EN 50085-2-2

INSERT FOR FLOOR DISTRIBUTION BOX 7M

- insert for floor box 7M
- metal, colour white RAL 9006
- mounting frame MODUL 7M included
- in accordance with EN 5005-1 and EN 50085-2-2

BODENDOSE FÜR DOPPELBODEN MIT DECKEL 2X7M



RB57S2

- Bodendose für Doppelboden 2x7M
- Metall, verzinkt
- Einbauloch 265x265 mm, Tiefe min. 100 mm
- Einstellhöhe 100-145 mm
- Bodendicke bis 11,5 mm
- entspricht EN 5005-1 und EN 50085-2-2

FLOOR BOX WITH COVER FOR DOUBLE FLOORS 2X7M

- floor box base 2x7M
- metal, galvanized
- mounting dimensions 265x265mm, min. depth 100mm
- adjustable height 100-145mm
- floor thickness up to 11.5mm
- in accordance with EN 5005-1 and EN 50085-2-2

EINSATZ FÜR BODENDOSEN 2X7M



RB62

- Einsatz für Bodendosen 2x7M
- Metall, weiß RAL 9006
- inkl. Montageträger MODUL 7Mx2
- entspricht EN 5005-1 und EN 50085-2-2

INSERT FOR FLOOR DISTRIBUTION BOX 2X7M

- insert for floor box 2x7M
- metal, colour white RAL 9006
- mounting frames MODUL 2x7M included
- in accordance with EN 5005-1 and EN 50085-2-2

BODENDOSE FÜR DOPPELBODEN MIT DECKEL 4X7M



RB58S2

- Bodendose für Doppelboden 4x7M
- Metall, verzinkt
- Einbauloch 265x516,5 mm, Tiefe min. 100 mm
- Einstellhöhe 100-145 mm
- Bodendicke bis 11,5 mm
- entspricht EN 5005-1 und EN 50085-2-2

FLOOR BOX WITH COVER FOR DOUBLE FLOORS 4X7M

- floor box base 4x7M
- metal, galvanized
- mounting dimensions 265x516.5mm, min. depth 100mm
- adjustable height 100-145mm
- floor thickness up to 11.5mm
- in accordance with EN 5005-1 and EN 50085-2-2

EINSATZ FÜR BODENDOSEN 2X7M



RB62

- Einsatz für Bodendosen 2x7M
- Metall, weiß RAL 9006
- inkl. Montageträger MODUL 7Mx2
- entspricht EN 5005-1 und EN 50085-2-2

INSERT FOR FLOOR DISTRIBUTION BOX 2X7M

- insert for floor box 2x7M
- metal, colour white RAL 9006
- mounting frames MODUL 2x7M included
- in accordance with EN 5005-1 and EN 50085-2-2

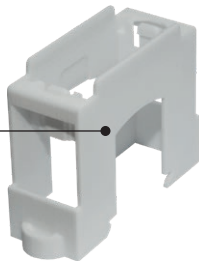

RB10

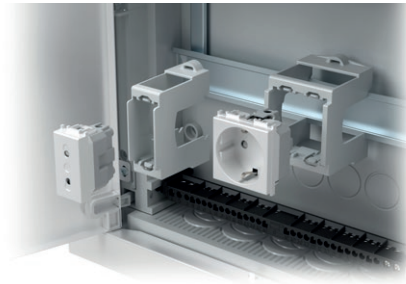

Typ type	Bezeichnung description	Technische Daten technical data
RB10	ADAPTER FÜR DIN-LEISTE ADAPTER FOR DIN RAIL	35mm 1M
RB11	ADAPTER FÜR DIN-LEISTE ADAPTER FOR DIN RAIL	35mm 2M
·	VERTEILERKASTEN	·
·	·	·
·	·	·

ADAPTER FÜR DIN-LEISTE 35mm 1M



RB10

- Adapter MODUL 1M
- für DIN-Leiste 35 mm
- entspricht EN 50022

ADAPTER FOR DIN RAIL 35mm 1M

- adapter MODUL 1M
- for DIN rail 35mm
- in accordance with EN 50022

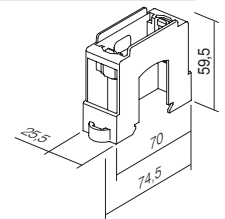

ADAPTER FÜR DIN-LEISTE 35mm 2M



RB11

- Adapter MODUL 2M
- für DIN-Leiste 35 mm
- entspricht EN 50022

ADAPTER FOR DIN RAIL 35mm 2M

- adapter MODUL 2M
- for DIN rail 35mm
- in accordance with EN 50022

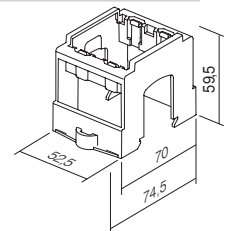

SWITCH
LOGIQ



TEM

LOGIQ

ALLGEGENWÄRTIGES SELBSTBEWUSSTSEIN **Gemacht für jeden Raum**

Ein Design, das in jedem Raum zu Hause ist. Die universellen Linien der Schalter prägen sowohl moderne Arbeitsumgebungen als auch gemütliche, warme Wohnräume. Für jeden Wunsch bietet Ihnen die Familie der LOGIQ-Schalter eine einfache und logische Lösung.

OMNIPRESENT CONFIDENCE made for every room

A shape for every room. The switches have universal lines that leave a mark in both modern work environments as well as in cosy, comfortable living spaces. The LOGIQ family offers a simple and logical solution for your every wish.



LOGIQ

HARMONIE DER FARBEN Wählen Sie Ihren Farbton

Die LOGIQ-Familie zeichnet sich durch eine logische Auswahl bewährter und eleganter Farben aus, die Benutzer bevorzugen. Sie müssen sich nicht der Linie anpassen, sondern die LOGIQ Linie passt sich Ihnen an, weshalb wir immer einen Farbton bieten können, der auf Ihre besonderen Wünsche zugeschnitten ist. Logisch.

HARMONY OF COLOURS Choose your hue

The LOGIQ family prides itself on its logical range of verified and elegant hues known and loved by our clients. Don't compromise, the LOGIQ family has you covered. We can always create the hue of colour in accordance with your special request. Logically.

- **Anthrazit** *anthracite*
- **Titan** *titanium*
- **Weiß glänzend** *polar white*



UNBEGRENZTE FANTASIE

Erstellen Sie Ihre eigene Kombination

Die LOGIQ-Familie ermöglicht es Ihnen, beliebige Kombinationen zusammenzustellen. Zum einfachen Kombinieren haben wir eine nützliche Ergänzung für Sie entwickelt, die Ihnen das Reißen von horizontalen und vertikalen Linien erleichtert. Das sogenannte 55/55-System ermöglicht es Ihnen, immer dieselben universellen Elemente zu verwenden. Wissen Sie schon, was Sie möchten? Keine Sorge, die LOGIQ-Schalter lesen Ihre Gedanken.

LIMITLESS IMAGINATION

Create your own combination

The LOGIQ family allows you to create your own combination. To make combining simple, we have created a useful system that supports the sequencing of horizontal and vertical lines. The so-called 55/55 system allows you to use the same universal elements every time. Know what you want? Don't worry, the LOGIQ switches can read your mind.



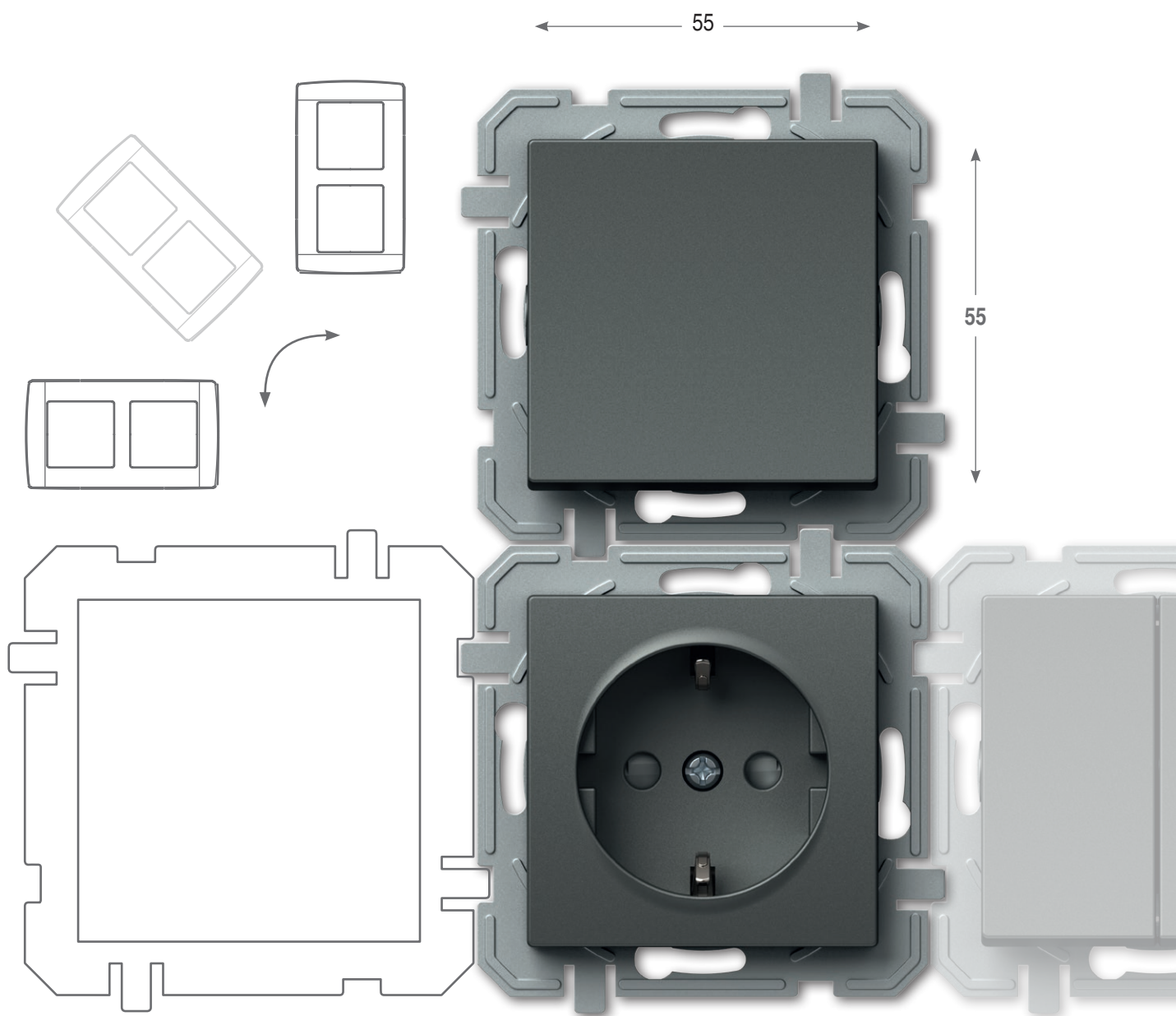

EINFACH FÜR DIE ANSPRUCHSVOLLSTEN

Die LOGIQ-Familie sind Schalter, Regler, Sensoren, Steckdosen für jeden Zweck und für jedermann an einem Ort. Sie können einzeln oder im Satz verwendet werden. Wie jede Familie, die wächst und sich entwickelt, werden wir auch unser Angebot entsprechend Ihren Bedürfnissen und Wünschen weiterentwickeln. Wir hören Ihnen gerne zu und bieten Ihnen eine Lösung, die eine einfache und logische Fortsetzung der LOGIQ-Familiengeschichte darstellt.

SIMPLE FOR THE MOST DEMANDING

The LOGIQ family offers switches, regulators, sensors, and sockets for every purpose in one place. You can use these products individually or in a sequence. Just like every family that grows and develops, the LOGIQ family will continue to develop our range of products in accordance with your needs and wishes. We are happy to listen to you and offer a solution which will simply and logically continue the story of the LOGIQ family.



ALLES AN EINER STELLE UND MEHR

ALL IN ONE PLACE AND MORE

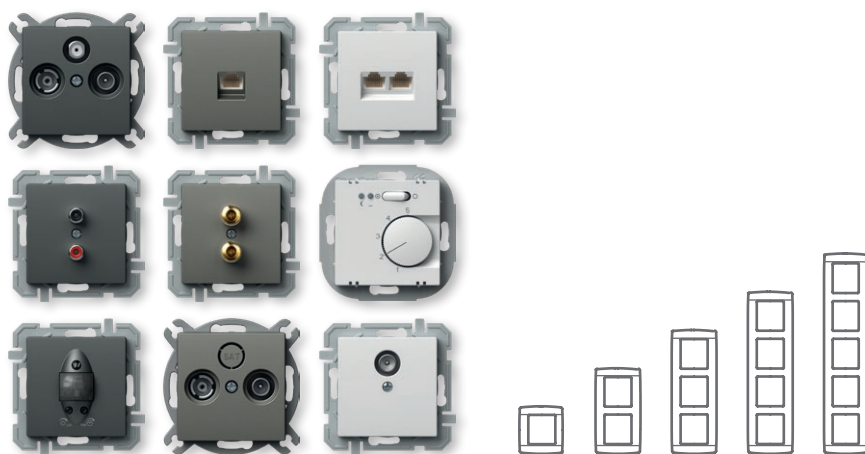

LOGISCHE MONTAGE

LOGIQ ist die Lösung für unser System der runden Standarddosen. Es ist für einfache wie auch anspruchsvollere Installationen, Neubauten und Umbauarbeiten geeignet. Das System zeichnet sich durch schraublose Kontakte aus, die Ihnen viel Zeit beim Einbau der Elemente ersparen.

LOGICAL INSTALLATION

LOGIQ is a solution for the system of standardized round installations boxes. It can be used for simple as well as more demanding installations, new buildings and adaptations. The system is characterised by plug-in contacts which save time during installation of elements.

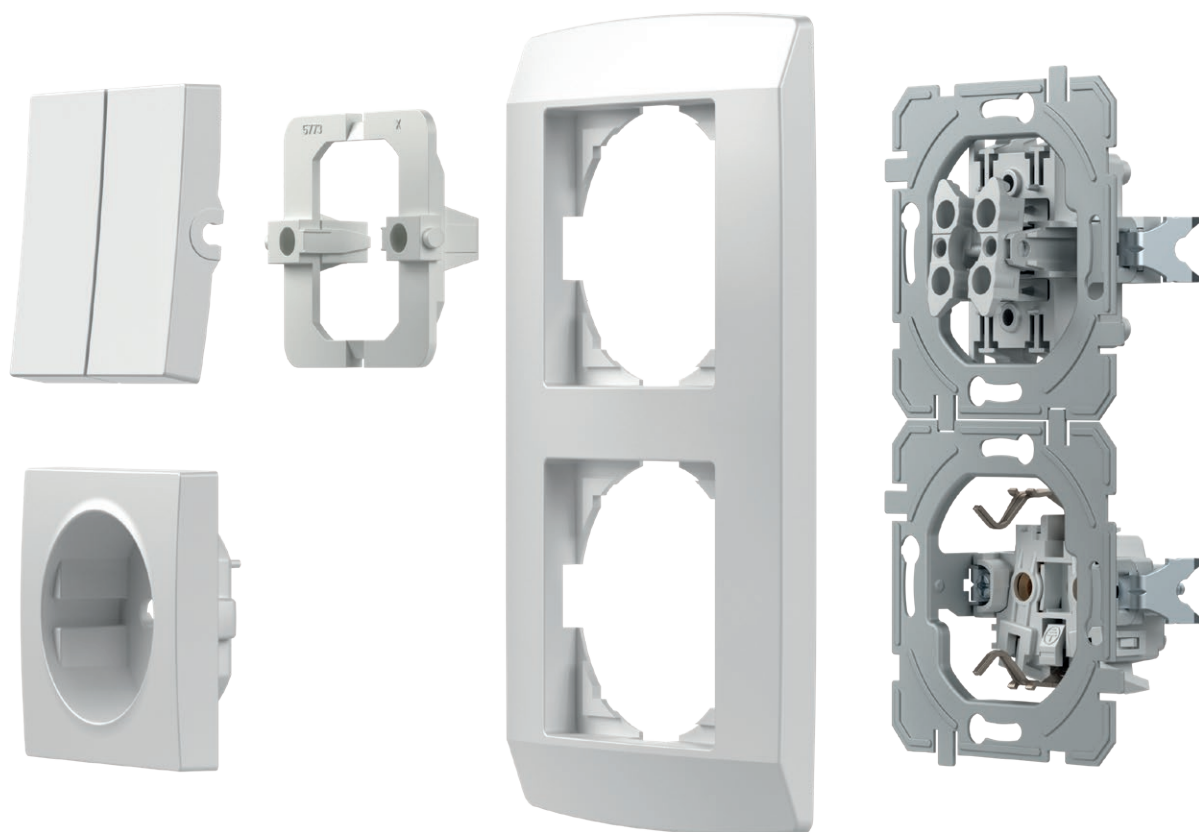

GUT ZU WISSEN

GOOD TO KNOW



Alle Steckdosen sind mit einem integrierten erhöhten Berührungsschutz ausgestattet.

All the sockets are equipped with a safety shutters assuring the protection to live contacts.



Die gut durchdachte Konstruktion des Schalters ermöglicht auch eine einfache nachträgliche Beleuchtung.

A well-planned switch construction makes easy illumination possible also subsequently.



Für eine zuverlässige Schaltung sorgen Kontakte aus einer Silberlegierung.

Contacts made of silver alloy guarantee safe switching.



Die schraubenlosen Kontakte ermöglichen einen schnellen und zuverlässigen Anschluss der Leitungen. An einem Kontakt können zwei Leitungen mit verschiedenen Durchmessern angeschlossen werden.

Plug-in contacts enable quick and reliable attachment of wires. Two wires of different diameters can be attached to the same contact.



Die Krallen ermöglichen eine tiefere Befestigung (auch an Fliesen usw.).

Fixing claws enable deeper fixing (also through ceramic tiles, etc.)



Erleichtern Sie sich die Arbeit mit schon zusammengesetzten Dosen, die Ihnen die richtigen Abstände gewährleisten.

Easy-fitting installation boxes will make your work easier. Proper lengths are guaranteed.

SQ11
PW
IN
01
XO

Typ type	Bezeichnung description	Technische Daten technical data	Farbe colour	Optionsbezeichnung 1 optional data 1	Optionsbezeichnung 2 optional data 2	Optionsbezeichnung 3 optional data 3
SQ10	SCHALTER 1-POLIG SWITCH 1WAY	10AX 250V~	<input type="checkbox"/> PW weiß-glänzend polar white	NT neutral neutral	01	XO ohne Rahmen without cover plate
SQ11	TASTER 1-POLIG PUSH BUTTON 1WAY	10A 250V~	<input type="checkbox"/> TI titan titanium	IN Indikator indicator	02	
SQ22	SCHALTER 2-POLIG SWITCH 2POLE	16AX 250V~	<input type="checkbox"/> AT anthrazit anthracite		03	
⋮	⋮	⋮			⋮	

SCHALTER 1-POLIG 10AX 250V~

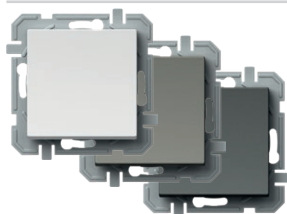

- SQ10PWXO
- SQ10TIXO
- SQ10ATXO



- 10AX 250V~, Typ SQ10
- entspricht EN 60669-1
- Steckklemmen 1,5–2,5 mm²

SWITCH 1WAY 10AX 250V~
- 10AX 250V~, type SQ10
- in accordance with EN 60669-1
- plug-in contacts 1.5-2.5mm²



SCHALTER 1-POLIG 10AX 250V~ __ IN

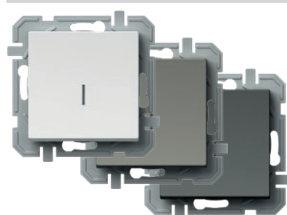

- SQ10PWINXO
- SQ10TIINXO
- SQ10ATINXO

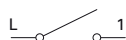

- IN Indikator, ohne Glühlampe
- 10AX 250V~, Typ SQ10
- entspricht EN 60669-1
- Steckklemmen 1,5–2,5 mm²

SWITCH 1WAY 10AX 250V~ __ IN
- IN indicator, without neon lamp
- 10AX 250V~, type SQ10
- in accordance with EN 60669-1
- plug-in contacts 1.5-2.5mm²



TASTER 1-POLIG 10A 250V~



- SQ11PWXO
- SQ11TIXO
- SQ11ATXO



- 10A 250V~, Typ SQ11
- entspricht EN 60669-1
- Steckklemmen 1,5–2,5 mm²

PUSH BUTTON 1WAY 10A 250V~
- 10A 250V~, type SQ11
- in accordance with EN 60669-1
- plug-in contacts 1.5-2.5mm²



TASTER 1-POLIG 10A 250V~ __ IN 01



- SQ11PWIN01XO
- SQ11TIIN01XO
- SQ11ATIN01XO



- IN 01 Indikator Klingel, ohne Glühlampe
- 10A 250V~, Typ SQ11
- entspricht EN 60669-1
- Steckklemmen 1,5–2,5 mm²

PUSH BUTTON 1WAY 10A 250V~ __ IN 01
- IN 01 indicator bell, without neon lamp
- 10A 250V~, type SQ11
- in accordance with EN 60669-1
- plug-in contacts 1.5-2.5mm²





- SQ11PWIN02XO
- SQ11TIIN02XO
- SQ11ATIN02XO



TASTER 1-POLIG 10A 250V~ __ IN 02

- IN 02 Indikator Licht, ohne Glühlampe
- 10A 250V~, Typ SQ11
- entspricht EN 60669-1
- Steckklemmen 1,5–2,5 mm²

PUSH BUTTON 1WAY 10A 250V~ __ IN 02

- IN 02 indicator light, without neon lamp
- 10A 250V~, type SQ11
- in accordance with EN 60669-1
- plug-in contacts 1.5-2.5mm²



- SQ22PWIN03XO
- SQ22TIIN03XO
- SQ22ATIN03XO

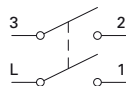

SCHALTER 2-POLIG 16AX 250V~ __ IN 03

- NT 03 neutral 0-1, ohne Glühlampe
- 16AX 250V~, Typ SQ22
- entspricht EN 60669-1
- Steckklemmen 1,5–2,5 mm²

SWITCH 2POLE 16AX 250V~ __ IN 03

- IN 03 neutral 0-1, without neon lamp
- 16AX 250V~, type SQ22
- in accordance with EN 60669-1
- screw contacts 1.5-2.5mm²



- SQ50PWXO
- SQ50TIXO
- SQ50ATXO

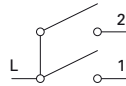

SCHALTER SERIEN 10AX 250V~

- 10AX 250V~, Typ SQ50
- entspricht EN 60669-1
- Steckklemmen 1,5–2,5 mm²

SWITCH 2GANG-1WAY 10AX 250V~

- 10AX 250V~, type SQ50
- in accordance with EN 60669-1
- plug-in contacts 1.5-2.5mm²

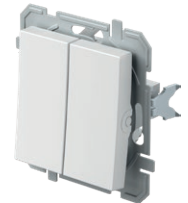

- SQ51PWXO
- SQ51TIXO
- SQ51ATXO

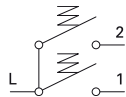

TASTER SERIEN 10A 250V~

- 10A 250V~, Typ SQ51
- entspricht EN 60669-1
- Steckklemmen 1,5–2,5 mm²

PUSH BUTTON 2GANG-1WAY 10A 250V~

- 10A 250V~, type SQ51
- in accordance with EN 60669-1
- plug-in contacts 1.5-2.5mm²



- SQ52PWNT09XO
- SQ52TINT09XO
- SQ52ATNT09XO

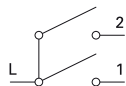

SCHALTER JALOUSIE 10AX 250V~ __ NT 09

- NT 09 neutral aufwärts-abwärts
- 10AX 250V~, Typ SQ52
- entspricht EN 60669-1
- Steckklemmen 1,5–2,5 mm²
- mit mechanischer Verriegelung

SWITCH SHUTTERS 10AX 250V~ __ NT 09

- NT 09 neutral up-down
- 10AX 250V~, type SQ52
- in accordance with EN 60669-1
- plug-in contacts 1.5-2.5mm²
- with mechanical interblock



- SQ53PWNT09XO
- SQ53TINT09XO
- SQ53ATNT09XO

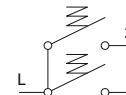

TASTER JALOUSIE 10A 250V~ __ NT 09

- NT 09 neutral aufwärts-abwärts
- 10A 250V~, Typ SQ53
- entspricht EN 60669-1
- Steckklemmen 1,5–2,5 mm²
- mit mechanischer Verriegelung

PUSH BUTTON SHUTTERS 10A 250V~ __ NT 09

- NT 09 neutral up-down
- 10A 250V~, type SQ53
- in accordance with EN 60669-1
- plug-in contacts 1.5-2.5mm²
- with mechanical interblock

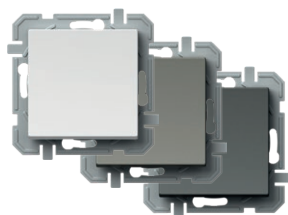

- SQ60PWXO
- SQ60TIXO
- SQ60ATXO

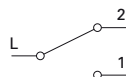

SCHALTER WECHSEL 10AX 250V~

- 10AX 250V~, Typ SQ60
- entspricht EN 60669-1
- Steckklemmen 1,5–2,5 mm²

SWITCH 2WAY 10AX 250V~

- 10AX 250V~, type SQ60
- in accordance with EN 60669-1
- plug-in contacts 1.5-2.5mm²



SCHALTER DOPPEL AUS/WECHSEL 10AX 250V~



- SQ63PWXO
- SQ63TIXO
- SQ63ATXO



- 10AX 250V~, Typ SQ63
 - entspricht EN 60669-1
 - Steckklemmen 1,5-2,5 mm²
SWITCH DOUBLE 2WAY 10AX 250V~
 - 10AX 250V~, type SQ63
 - in accordance with EN 60669-1
 - plug-in contacts 1.5-2.5mm²



SCHALTER KREUZ 10AX 250V~

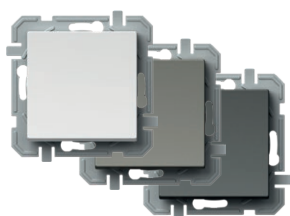

- SQ70PWXO
- SQ70TIXO
- SQ70ATXO



- 10AX 250V~, Typ SQ70
 - entspricht EN 60669-1
 - Steckklemmen 1,5-2,5 mm²
SWITCH INTERMEDIATE 10AX 250V~
 - 10AX 250V~, type SQ70
 - in accordance with EN 60669-1
 - plug-in contacts 1.5-2.5mm²



SQ10
SQ11

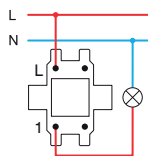

SQ22

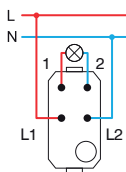

SQ50
SQ51

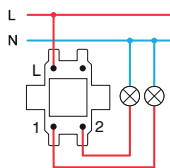

SQ52
SQ53

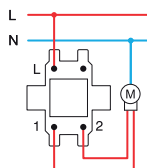

SQ60+SQ60

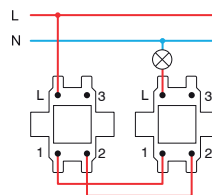

SQ63+SQ63

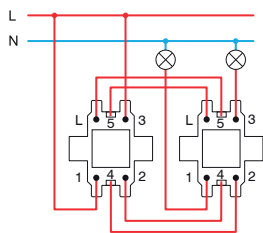

SQ60+SQ70+SQ60

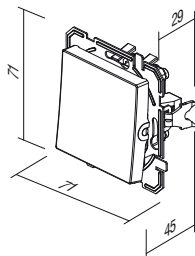
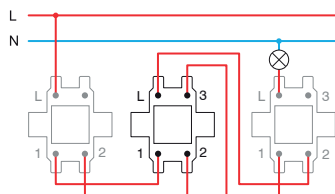

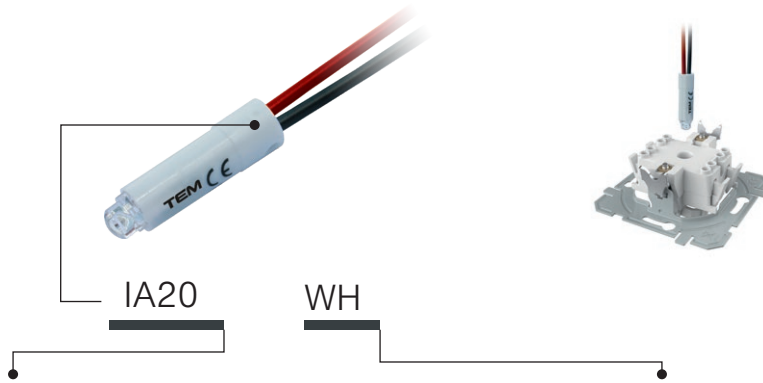

Typ type	Bezeichnung description	Technische Daten technical data	Farbe colour
IA10	GLÜHLAMPE NEON LAMP	230V~ 0,34W	<input type="checkbox"/> WH weiß white
IA20	LED-LAMPE LED LAMP	230V~ 0,40W	<input checked="" type="checkbox"/> BL blau blue
IA21	LED-LAMPE LED LAMP	24V AC/DC 0,20W	<input checked="" type="checkbox"/> RD rot red
·	·	·	<input checked="" type="checkbox"/> GR grün green
·	·	·	<input checked="" type="checkbox"/> OR orange orange

GLÜHLAMPE 230V~ 0,34 W

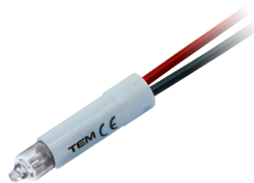

IA10OR

- zur Kontrollbeleuchtung, Beleuchtung oder ständige Beleuchtung des Schalters
- in Kombination mit Wippe mit einem Indikator
NEON LAMP 230V~ 0,34W
- for indication, illumination or constant illumination of switch
- in combination with button with indicator

LED-LAMPE 230V AC/DC 0,40 W

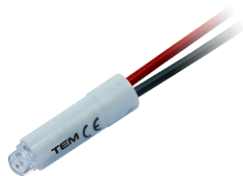

IA20WH
 IA20GR
 IA20RD
 IA20BL

- zur Kontrollbeleuchtung, Beleuchtung oder ständige Beleuchtung des Schalters
- in Kombination mit Wippe mit einem Indikator
LED LAMP 230V AC/DC 0,40W
- for indication, illumination or constant illumination of switch
- in combination with button with indicator

LED-LAMPE 24V AC/DC 0,20W



IA21WH
 IA21RD

- zur Kontrollbeleuchtung, Beleuchtung oder ständige Beleuchtung des Schalters
- in Kombination mit Wippe mit einem Indikator
LED LAMP 24V AC/DC 0,20W
- for indication, illumination or constant illumination of switch
- in combination with button with indicator

LED-LAMPE 12V AC/DC 0,10W

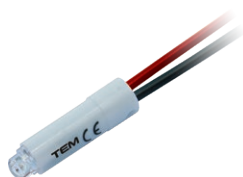

IA22WH
 IA22RD

- zur Kontrollbeleuchtung, Beleuchtung oder ständige Beleuchtung des Schalters
- in Kombination mit Wippe mit einem Indikator
LED LAMP 12V AC/DC 0,10W
- for indication, illumination or constant illumination of switch
- in combination with button with indicator

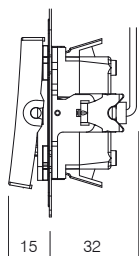

Kontrollbeleuchtung /
Indication

*Beleuchtung /
Illumination

Ständige Beleuchtung /
Illumination always on

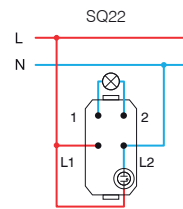
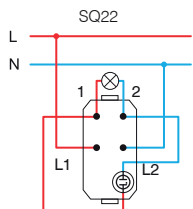
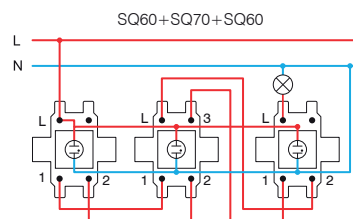
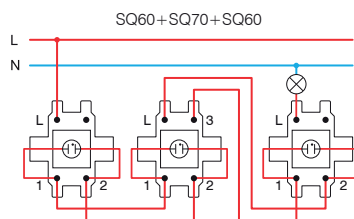
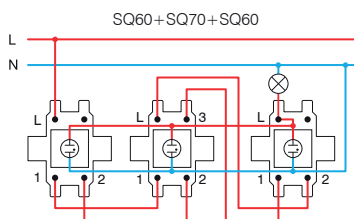
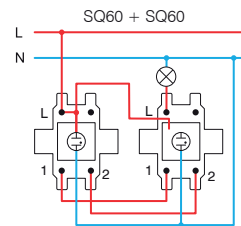
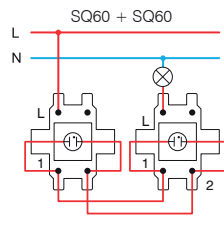
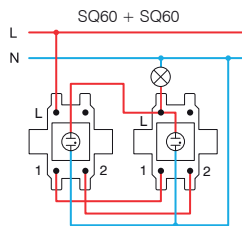
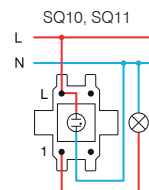
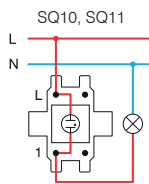
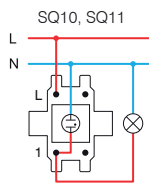

* die Schaltungen sind nicht geeignet für Sparlampen (CFL, LED) /
the connections are not suitable for energy-saving bulbs (CFL, LED)

S O C K E T S V Q

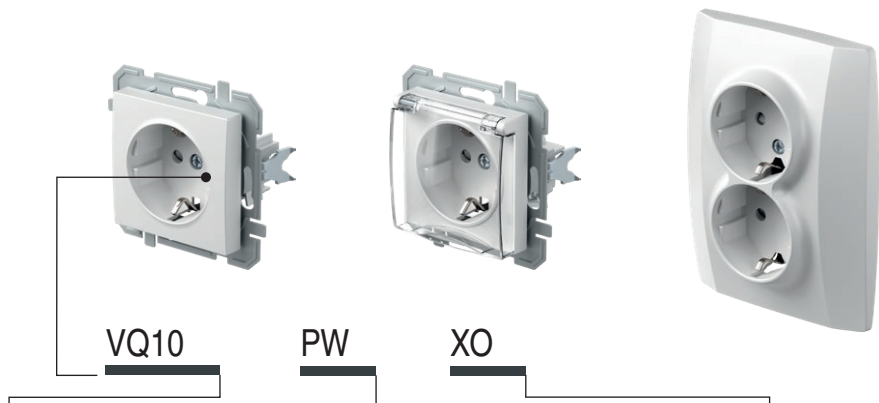

Typ type	Bezeichnung description	Technische Daten technical data	Optionsbezeichnung 1 optional data 1
VQ10	STECKDOSE SCHUKO SOCKET SCHUKO	2P+E 16A 250V~	XO ohne Rahmen without cover plate
VQ11	STECKDOSE SCHUKO+KLAPPDECKEL SOCKET SCHUKO+COVER	2P+E 16A 250V~	
VQ12	STECKDOSE SCHUKO SOCKET SCHUKO	2P+E 16A 250V~ BV	
:	:	:	
:	:	:	

Farbe
colour

<input type="checkbox"/> PW	weiß-glänzend polar white	<input type="checkbox"/> PT	weiß + transparent white+transparent	<input type="checkbox"/> PP	weiß + weiß white+white
<input type="checkbox"/> TI	titan titanium	<input type="checkbox"/> TT	titan + transparent titanium+transparent	<input type="checkbox"/> TI	titan + titan titanium+titanium
<input type="checkbox"/> AT	anthrazit anthracite	<input type="checkbox"/> AT	anthrazit + transparent anthracite+transparent	<input type="checkbox"/> AA	anthrazit + anthrazit anthracite+anthracite
<input type="checkbox"/> RD	rot red	<input type="checkbox"/> RT	rot + transparent red+transparent	<input type="checkbox"/> RR	rot + rot red+red
<input type="checkbox"/> GR	grün green	<input type="checkbox"/> GT	grün + transparent green+transparent	<input type="checkbox"/> GG	grün + grün green+green
<input type="checkbox"/> OR	orange orange	<input type="checkbox"/> OT	orange + transparent orange+transparent	<input type="checkbox"/> OO	orange + orange orange+orange



Schuko – entspricht EN 60884-1, CEE7 (Blatt III)

schuko - in accordance with EN 60884-1, CEE7 (standard sheet III)

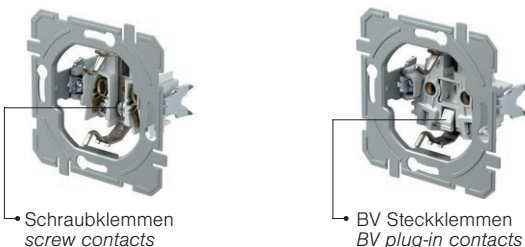

Schraubklemmen
screw contacts

BV Steckklemmen
BV plug-in contacts

STECKDOSE SCHUKO 2P+E 16A 250V~ __ XO

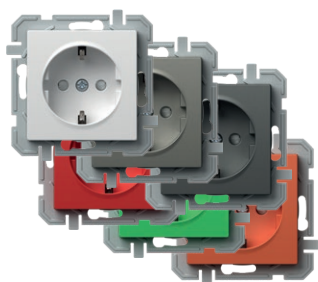

- VQ10PWXO
- VQ10TIXO
- VQ10ATXO
- VQ10RDXO
- VQ10GRXO
- VQ10ORXO

- Schraubklemmen 1,5–2,5 mm²
- XO ohne Rahmen
- Steckdose mit Schutzkontakt
- 16A 250V~, Typ VQ10
- KS - mit Kinderschutz



SOCKET SCHUKO 2P+E 16A 250V~ __ XO

- screw contacts 1.5-2.5mm²
- XO without surround
- 2P+E schuko
- 16A 250V~, type VQ10
- KS build-in child protection – shuttered live contacts

STECKDOSE SCHUKO+DECKEL 2P+E 16A 250V~ __ XO

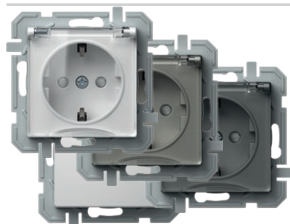

- VQ11PTXO
- VQ11TTXO
- VQ11ATXO
- VQ11PPXO

- Schraubklemmen 1,5–2,5 mm²
- XO ohne Rahmen
- Steckdose mit Schutzkontakt mit Klappdeckel
- 16A 250V~, Typ VQ11
- KS - mit Kinderschutz



SOCKET SCHUKO+COVER 2P+E 16A 250V~ __ XO

- screw contacts 1.5-2.5mm²
- XO without surround
- 2P+E schuko+cover
- 16A 250V~, type VQ11
- KS build-in child protection – shuttered live contacts

STECKDOSE SCHUKO 2P+E 16A 250V~ BV_XO

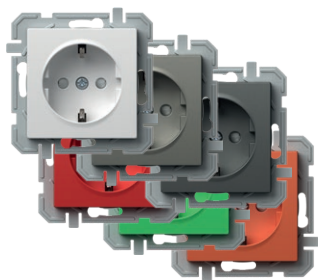

- VQ12PWXO
- VQ12TIXO
- VQ12ATXO
- VQ12RDXO
- VQ12GRXO
- VQ12ORXO

- BV – Steckklemmen 1,5–2,5 mm²
- XO ohne Rahmen
- Steckdose mit Schutzkontakt
- 16A 250V~, Typ VQ12
- KS - mit Kinderschutz



SOCKET SCHUKO 2P+E 16A 250V~ BV __ XO

- BV plug-in contacts 1.5-2.5mm²
- XO without surround
- 2P+E schuko
- 16A 250V~, type VQ12
- KS build-in child protection – shuttered live contacts

STECKDOSE SCHUKO+KLAPPDECKEL 2P+E 16A 250V~ BV __ XO

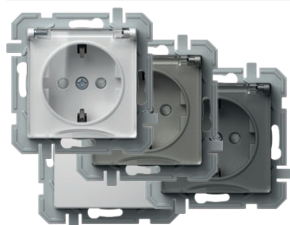

- VQ13PTXO
- VQ13TTXO
- VQ13ATXO
- VQ13PPXO

- BV – Steckklemmen 1,5–2,5 mm²
- XO ohne Rahmen
- Steckdose mit Schutzkontakt mit Klappdeckel
- 16A 250V~, Typ VQ13
- KS - mit Kinderschutz



SOCKET SCHUKO+COVER 2P+E 16A 250V~ BV __ XO

- BV plug-in contacts 1.5-2.5mm²
- XO without surround
- 2P+E schuko+cover
- 16A 250V~, type VQ13
- KS build-in child protection – shuttered live contacts

STECKDOSE SCHUKO DOPPELT 2P+E 16A 250V~



- VQ16PW
- VQ16TI
- VQ16AT

- Doppelsteckdose mit Schutzkontakt
- 16A 250V~, Typ VQ16
- entspricht IEC 60884-1, CEE7
- Schraubklemmen 1,5-2.5 mm²
- KS - mit Kinderschutz



SOCKET SCHUKO DOUBLE 2P+E 16A 250V~

- 2P+E schuko double
- 16A 250V~, type VQ16
- in accordance with IEC 60884-1, CEE7
- screw contacts 1.5-2.5 mm²
- KS build-in child protection – shuttered live contacts

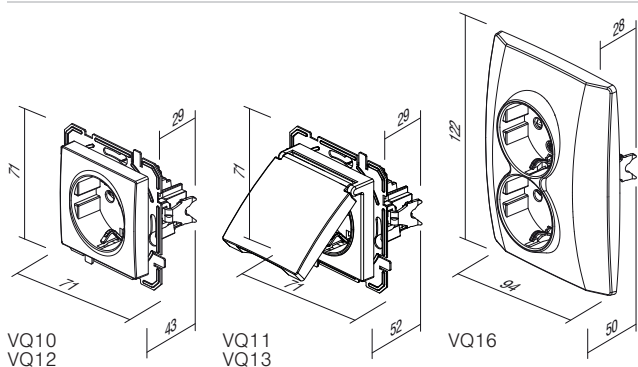

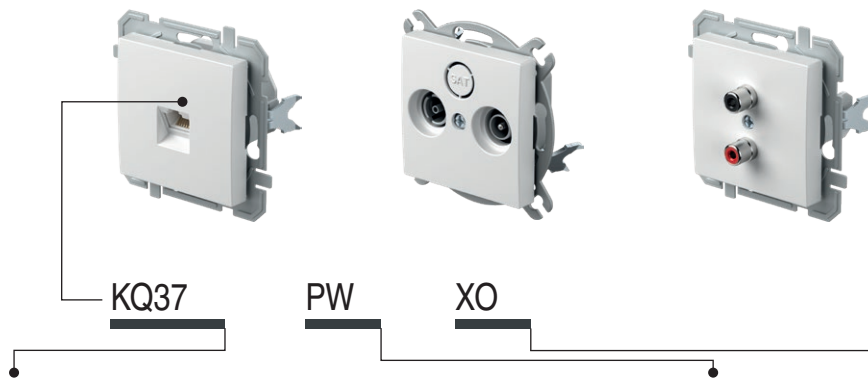

Typ type	Bezeichnung description	Technische Daten technical data	Farbe colour	Optionsbezeichnung 1 optional data 1
KQ11	STECKDOSE TV-R ENDDOSE SOCKET TV-R END-LINE	1dB	<input type="checkbox"/> PW weiß-glänzend polar white	XO ohne Rahmen without cover plate
KQ12	STECKDOSE TV-R DURCHGANGSDOSE SOCKET TV-R THROUGHPASS	10dB	<input type="checkbox"/> TI titan titanium	
KQ16	STECKDOSE SAT-TV-R ENDDOSE SOCKET SAT-TV-R END-LINE	3dB	<input type="checkbox"/> AT anthrazit anthracite	
⋮	⋮	⋮		

STECKDOSE TV-EINZELDOSE 0dB



- KQ10PWXO
- KQ10TIXO
- KQ10ATXO

- TV-Einzeldose
- Dämpfung 0 dB
- Rückanschluss – F-Standard

SOCKET TV BASIC 0dB

- TV basic
- reduction 0dB
- back connector – F standard



STECKDOSE TV-R-ENDDOSE 1dB



- KQ11PWXO
- KQ11TIXO
- KQ11ATXO

- TV-R-Enddose
- Übertragungsbandbreite 5-862 MHz
- Dämpfung: R-1.5dB, TV-1dB
- entspricht EN 50083-1
- Schraubklemmen

SOCKET TV-R END-LINE 1dB

- TV-R end-line
- frequency range 5-862 MHz
- reduction: R-1.5dB, TV-1dB
- in accordance with EN 50083-1
- screw contact



STECKDOSE TV-R DURCHGANGSDOSE 10dB



- KQ12PWXO
- KQ12TIXO
- KQ12ATXO

- TV-R-Durchgangsdose
- Übertragungsbandbreite 5-862 MHz
- Dämpfung: R-10dB, TV-10dB, Durchgang-2dB
- entspricht EN 50083-1
- Schraubklemmen

SOCKET TV-R THROUGHPASS 10dB

- TV-R throughpass
- frequency range 5-862 MHz
- reduction: R-10dB, TV-10dB, through-2dB
- in accordance with EN 50083-1
- screw contacts



STECKDOSE SAT-TV-R-ENDDOSE 3dB



- KQ16PWXO
- KQ16TIXO
- KQ16ATXO

- SAT-TV-R-Enddose
- Übertragungsbandbreite 5-2400 MHz
- Dämpfung: R-1 dB, TV-1.5 dB, SAT-3 dB
- entspricht EN 50083-1
- Schraubklemmen

SOCKET SAT-TV-R END-LINE 3dB

- SAT-TV-R end-line
- frequency range 5-2400 MHz
- reduction: R-1dB, TV-1.5dB, SAT-3dB
- in accordance with EN 50083-1
- screw contacts



STECKDOSE AUDIO 2xRCA



- KQ22PWXO
- KQ22TIXO
- KQ22ATXO

- Audio 2xRCA
 - geloteter Kabelanschluss
SOCKET AUDIO 2xRCA
 - audio 2xRCA
 - soldering connection of cable



STECKDOSE AUDIO FÜR LAUTSPRECHER



- KQ23PWXO
- KQ23TIXO
- KQ23ATXO

- Audio-Anschlussdose – 2x Ø4 mm
 - Kabelanschluss für Lautsprecher, Stecker Ø4 mm oder Gabel-Kabelstecker
 - gelöteter Kabelanschluss hinten
SOCKET AUDIO LOUDSPEAKERS
 - audio 2x Ø4mm
 - to accommodate speaker wire, banana plug Ø4mm or spades
 - soldering connection of cable at the back side



STECKDOSE TEL KS RJ11 6/4

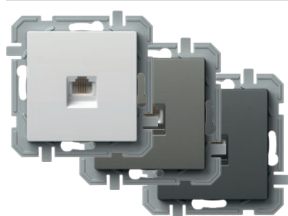

- KQ36PWXO
- KQ36TIXO
- KQ36ATXO

- KS – keystone-Befestigungsstandard
 - RJ11 6/4
 - entspricht IEC 60603-7
SOCKET TEL KS RJ11 6/4
 - KS keystone fixing standard
 - RJ11 6/4
 - in accordance with IEC 60603-7



STECKDOSE CAT5e KS RJ45 8/8



- KQ37PWXO
- KQ37TIXO
- KQ37ATXO

- KS – keystone-Befestigungsstandard
 - CAT5e, RJ45 8/8
 - entspricht IEC 60603-7
SOCKET CAT5e KS RJ45 8/8
 - KS keystone fixing standard
 - CAT5e, RJ45 8/8
 - in accordance with IEC 60603-7



STECKDOSE TEL KS DOPPELT 2x RJ11 6/4



- KQ38PWXO
- KQ38TIXO
- KQ38ATXO

- KS – keystone-Befestigungsstandard
 - 2x RJ11 6/4
 - entspricht IEC 60603-7
SOCKET TEL KS DOUBLE 2x RJ11 6/4
 - KS keystone fixing standard
 - 2x RJ11, 6/4
 - in accordance with IEC 60603-7



STECKDOSE CAT5e KS DOPPELT 2x RJ45 8/8

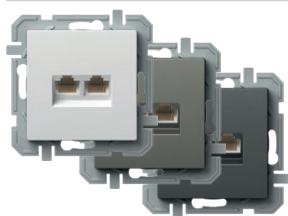

- KQ39PWXO
- KQ39TIXO
- KQ39ATXO

- KS – keystone-Befestigungsstandard
 - 2x CAT5e, RJ45 8/8
 - entspricht IEC 60603-7
SOCKET CAT5e KS DOUBLE 2x RJ45 8/8
 - KS keystone fixing standard
 - 2x CAT5e, RJ45 8/8
 - in accordance with IEC 60603-7



STECKDOSE TEL LT RJ11 6/4

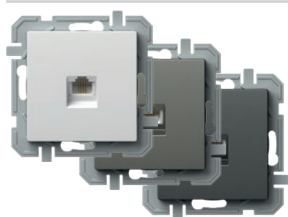

- KQ35PWXO
- KQ35TIXO
- KQ35ATXO

- TEL LT mit Schraubklemmen
 - Schraubklemmen
 - RJ11 6/4
 - entspricht IEC 60603-7
SOCKET TEL LT RJ11 6/4
 - TEL LT screw
 - screw contacts
 - RJ11 6/4
 - in accordance with IEC 60603-7





- KQ40PWXO
- KQ40TIXO
- KQ40ATXO

STECKDOSE CAT6s KS RJ45 8/8 SLIM

- KS – keystone-Befestigungsstandard
- CAT6s, RJ45 8/8
- entspricht IEC 60603-7

SOCKET CAT6s KS RJ45 8/8 SLIM

- KS keystone fixing standard
- CAT6s, RJ45 8/8
- in accordance with IEC 60603-7

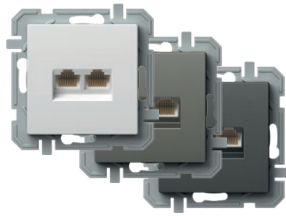

- KQ41PWXO
- KQ41TIXO
- KQ41ATXO

STECKDOSE CAT6s KS DOPPELT 2x RJ45 8/8 SLIM

- KS – keystone-Befestigungsstandard
- 2x CAT6s, RJ45 8/8
- entspricht IEC 60603-7

SOCKET CAT6s KS DOUBLE 2x RJ45 8/8 SLIM

- KS keystone fixing standard
- 2x CAT6s, RJ45 8/8
- in accordance with IEC 60603-7

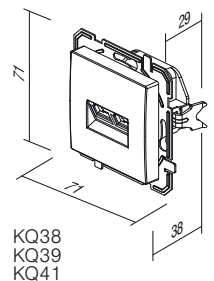
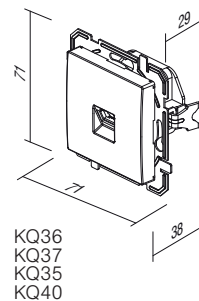
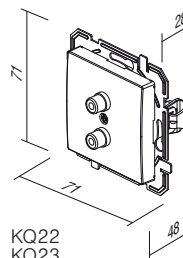
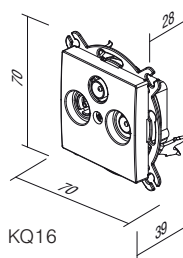
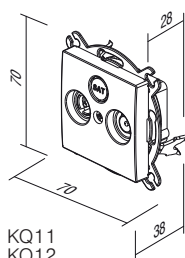
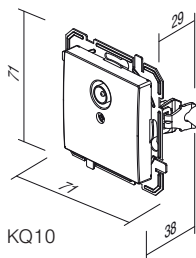



EQ15

PW

XO

Typ type	Bezeichnung description	Technische Daten technical data	Farbe colour	Optionsbezeichnung 1 optional data 1
EQ15	DIMMER DREH-WECHSEL DIMMER ROTATIVE 2WAY	RL 400W	<input type="checkbox"/> PW weiß-glänzend polar white	XO ohne Rahmen without cover plate
EQ16	DIMMER DREH-WECHSEL DIMMER ROTATIVE 2WAY	RLC 400W	<input type="checkbox"/> TI titan titanium	
EQ19	DIMMER DREH-WECHSEL DIMMER ROTATIVE 2WAY	LED 100W	<input type="checkbox"/> AT anthrazit anthracite	
⋮	⋮	⋮		

DIMMER DREH-WECHSEL RL 400W

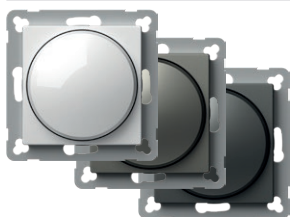

- EQ15PWXO
- EQ15TIXO
- EQ15ATXO

- Dreh-Wechsel
- Belastung RL, 40W – 400W
- kann mit Wechselschalter verbunden werden
- Verbindung von zwei Dimmern ist nicht gestattet
- entspricht EN 60669-1 und EN 60669-2-1
- Schraubklemmen 1,5 mm²
- Versorgung 230 V[~] 50 Hz
- inkl. Sicherung auswechselbar



DIMMER ROTATIVE 2WAY RL 400W

- rotation control with 2-way switch
- load RL, 40W - 400W
- 2-way switch combination is possible
- more dimmers combination is not allowed
- in accordance with EN 60669-1 and EN 60669-2-1
- plug-in contacts 1.5mm²
- supply 230V[~] 50Hz
- replaceable fuse included

DIMMER DREH-WECHSEL RLC 400W

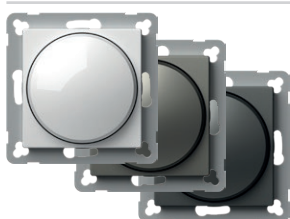

- EQ16PWXO
- EQ16TIXO
- EQ16ATXO

- Dreh-Wechsel
- Belastung RL, 20–400 W
- kann mit Wechselschalter verbunden werden
- Verbindung von zwei Dimmern ist nicht gestattet
- entspricht EN 60669-1 und EN 60669-2-1
- Steckklemmen 1,5 mm²
- Versorgung 230 V[~] 50 Hz
- Elektroniksicherung



DIMMER ROTATIVE 2WAY RLC 400W

- rotation control with 2-way switch
- load RLC, 20W - 400W
- 2-way switch combination is possible
- more dimmers combination is not allowed
- in accordance with EN 60669-1 and EN 60669-2-1
- plug-in contacts 1.5mm²
- supply 230V[~] 50Hz
- electronic fuse

DIMMER DREH-WECHSEL LED 100W



- EQ19PWXO
- EQ19TIXO
- EQ19ATXO

- Dreh-Wechsel
- Belastung: LED, 0-100 W (max. 10 LED-Lampen)
- GLS, 10–250 W
- kann mit Wechselschalter verbunden werden
- Verbindung von zwei Dimmern ist nicht gestattet
- entspricht EN 60669-1 und EN 60669-2-1
- Schraubklemmen 1,5 mm²
- Versorgung 230 V[~] 50 Hz
- inkl. Sicherung auswechselbar



DIMMER ROTATIVE 2WAY LED 100W

- rotation control with 2-way switch
- load: LED, 0-100W (max. 10 LEDs)
- GLS, 10-250W
- 2-way switch combination is possible
- more dimmers combination is not allowed
- in accordance with EN 60669-1 and EN 60669-2-1
- plug-in contacts 1.5mm²
- supply 230V[~] 50Hz
- replaceable fuse included

EQ15, EQ16, EQ19

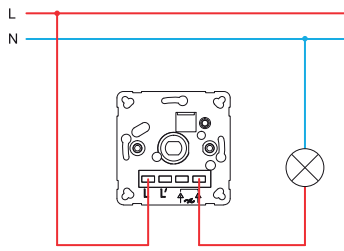

EQ15, EQ16, EQ19

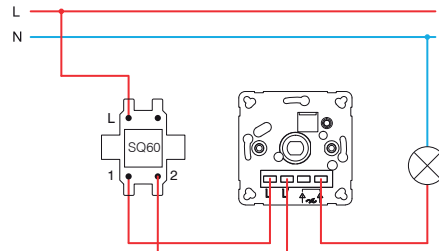

EQ15, EQ16, EQ19

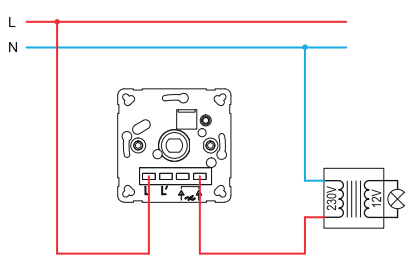

EQ15, EQ16, EQ19

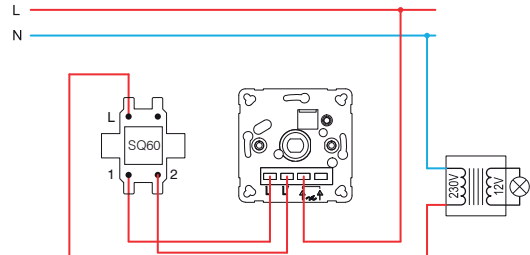

EQ16, EQ19

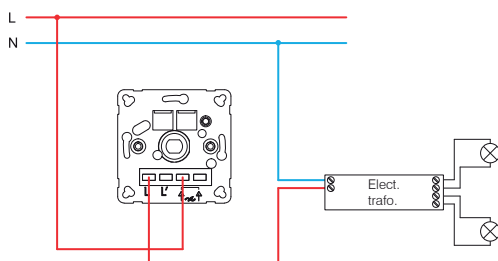

EQ16, EQ19

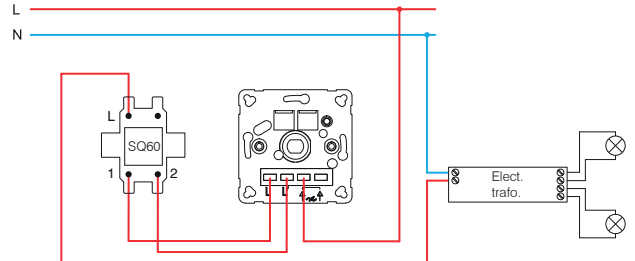

EQ15 (40÷400W)

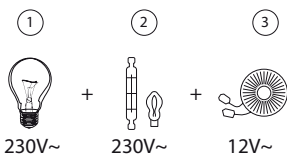

- 1 – Glühlampe / incandescent lamp
- 2 – Halogenlampe / halogen lamp

EQ16 (20÷400W)

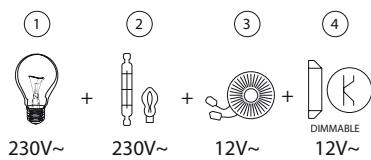

- 3 – klassischer Transformator / classical transformer
- 4 – Dimmbarer elektronischer Transformator / dimmable electronic transformer
- 5 – dimmbare LED-Lampe / dimmable LED lamp

EQ19 (GLS 10÷250W ; LED 0÷100W)

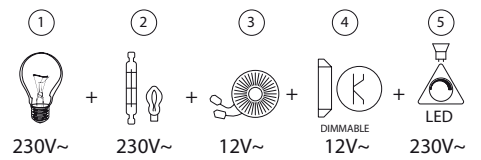

IR SCHALTER 5A 230V~



- EQ32PWXO
- EQ32TIXO
- EQ32ATXO

- IR-Schalter
- Versorgung: 230V~ ±10 % 50Hz
- Relais: 5A / 250V~ Ausgang mit hochohmigen Strombegrenzung für den Nulldurchgang
- Schutzart: IP40
- Schraubklemmen: 0,75–2,5 mm²
- Erfassungswinkel: bis 110° bei 20°C
- Erfassungsbereich: ca. 8 m bei 20°C
- Einstellung der Beleuchtungszeit: ab ca. 5 s bis 12 min
- Beleuchtungseinstellung: von ca. 5 bis 200 Lx
- Betriebstemperatur: von 0°C bis + 40°C
- nicht geeignet für den Einbau in Dosen mit Tiefe 45 mm
- nur für Gebrauch im Innenbereich

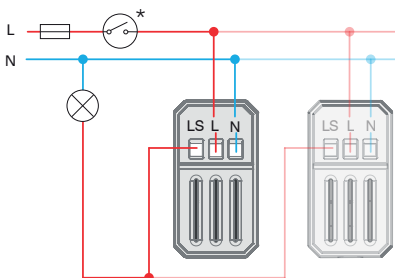

IR SWITCH 5A 230V~

- IR infrared switch
- supply voltage: 230V~ ±10 % 50Hz
- relay: 5A / 250V~ output for limited current with high resistance for zero crossing
- protection rating: IP40
- cross-section of wires at the contact terminal: 0.75 - 2.5 mm²
- detection angle: up to 110° at 20°C
- detection area: approx. 8 m at 20°C
- adjustability of duration: from approx. 5 s to 12 min
- adjustability of brightness: from approx. 5 to 200 LUX
- operating temperature: from 0°C to +40°C
- not suitable for installation in 45 mm deep boxes
- only for indoor usage

THERMOSTAT HEIZUNG 10A 230V~

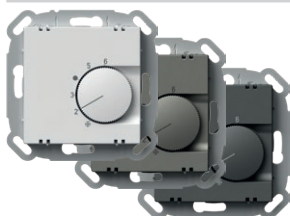

- EQ35PWXO
- EQ35TIXO
- EQ35ATXO

- Betriebsart: Heizung
- Versorgung: 230 V~, 50 Hz
- Ausgang: 4 A (max. 10 A), 230 V~, 50 Hz
- Ausgang: NC (max. 10 Aktoren)
- Regulierungsbereich: +5 °C bis +30 °C
- Hysterese: 0,5 K
- Schutzart: IP30
- Sensorart: bimetal
- elektrischer Anschluss: Steckklemmen
- Leitung Typ: 0,75–1,5 mm² (Weichdraht) oder 1,0–2,5 mm² (Hartdraht)

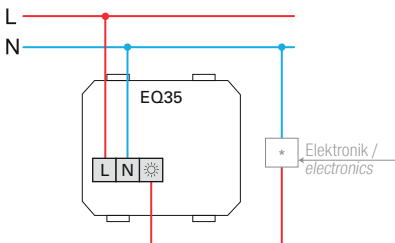

THERMOSTAT HEATING 10A 230V~

- operation mode: heating
- power supply: 230 V~, 50 Hz
- output: 4 A (max. 10 A), 230 V~, 50 Hz
- switching contact: NC (max. 10 actuators)
- regulation range: +5 °C to +30 °C
- hysteresis: 0,5 K
- protection: IP30
- sensor type: bimetal
- type of electrical connection: spring-loaded contacts
- type of conductors: 0,75 – 1,5mm² (flexible-stranded core) or 1,0 – 2,5 mm² (solid core)

THERMOSTAT HEIZUNG / KÜHLUNG 5A 230V~

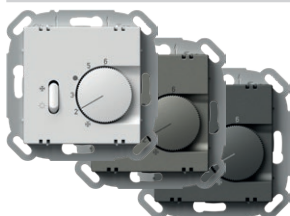

- EQ36PWXO
- EQ36TIXO
- EQ36ATXO

- Betriebsart: Heizung / Kühlung
- Versorgung: 230 V~, 50 Hz
- Ausgang: 2 A (max. 5 A), 230 V~, 50 Hz
- Ausgang: Umschalter (max. 5 Aktoren)
- Regulierungsbereich: +5 °C bis +30 °C
- Hysterese: 0,5 K
- Schutzart: IP30
- Sensorart: bimetal
- elektrischer Anschluss: Steckklemmen
- Leitung Typ: 0,75–1,5 mm² (Weichdraht) oder 1,0–2,5 mm² (Hartdraht)

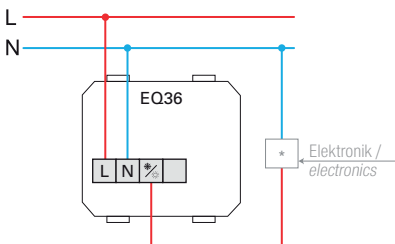

THERMOSTAT HEATING / COOLING 5A 230V~

- operation mode: heating / cooling
- power supply: 230 V~, 50 Hz
- output: 2 A (max. 5 A), 230 V~, 50 Hz
- switching contact: changeover switch (toggle, max. 5 actuators)
- regulation range: +5 °C to +30 °C
- hysteresis: 0,5 K
- protection: IP30
- sensor type: bimetal
- type of electrical connection: spring-loaded contacts
- type of conductors: 0,75 – 1,5mm² (flexible-stranded core) or 1,0 – 2,5 mm² (solid core)

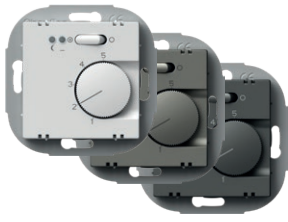

- EQ37PWXO
- EQ37TIXO
- EQ37ATXO

THERMOSTAT BODENHEIZUNG 16A 230V~

- Betriebsart: Bodenheizung
- Versorgung: 230 V~, 50 Hz
- Ausgang: 2 A (max. 16 A), 230 V~, 50 Hz
- Regulierungsbereich: +10 °C bis +50 °C
- Hysterese: 1 K
- Schutzart: IP30
- Sensorart: NTC nach DIN EN 60730-2-1
- Indikator: rote LED für Heizung ein
grüne LED für reduzierten Nacht-Modus
- elektrischer Anschluss: Schraubklemmen
- Leitung Typ: 0,5–2,5 mm²

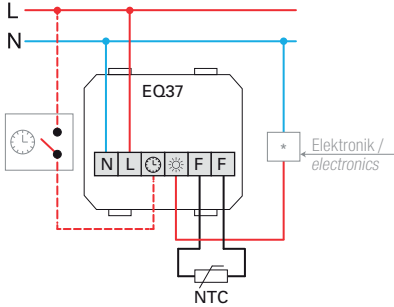

THERMOSTAT FLOOR HEATING 16A 230V~

- operation mode: floor heating
- power supply: 230 V~, 50 Hz
- output: 2 A (max. 16 A), 230 V~, 50 Hz
- regulation range: +10 °C to +50 °C
- hysteresis: 1 K
- protection: IP30
- sensor type: NTC in compliance with DIN EN 60730-2-1
- indicators: Red LED for heating and green LED for night decrease mode
- type of electrical connection: Screw contacts
- type of conductors: 0,5 – 2,5mm²



- EQ68PW
- EQ68TI
- EQ68AT

LADEGERÄT USB 5V 3,0A

- zum Laden der elektronischen Geräte über einen Standard-USB-Anschluss (kompatibel mit Apple-Geräten)
- Versorgung: 100 - 230 V~ 50 / 60 Hz
- Verbrauch während des Betriebs
300 mA bei 100 V~ / 150 mA bei 230 V~
- Verbrauch in Bereitstellung 30 mW bei 230 V~
- Ausgangsspannung 5 VDC (+/- 5 %) SELV
- Schwankungen der Ausgangsspannung 150 mV
- nominaler Ausgangsstrom 3,0 A (±10 %)
- Konnektortyp: USB A / USB C
- Nutzleistung: max. 77 %
- Betriebstemperatur: 0 °C / +45 °C (im Innenbereich)
- Schutzart: IP20, nur für Gebrauch im Innenbereich geeignet
- Schutzklasse des Gerätes II
- Überspannungsschutz (EN 62109): Klasse III
- Schraubklemmen max. 2,5 mm²
- Gerät mit Kontaktversatz min. 3 mm
- entspricht EN 60950-1 und der EMC- und LVD-Richtlinie



USB POWER SUPPLY UNIT 5V 3.0A

- for charging electronic devices via a standard USB port (also compatible with Apple devices)
- power supply: 100-230V~ 50/60Hz
- power consumption: 300mA at 100V~/150mA at 230V~
- standby power consumption: 30mW at 230V~
- nominal output voltage: 5 VCD (± 5%) SELV
- output ripple voltage: 150mV
- nominal output current: 3.0 A (±10%)
- connector type: USB A / USB C
- efficiency: maximum of 77%
- operating temperature: 0°C/+45°C (indoor use)
- IP protection class: IP20, indoor use only
- class device II
- overvoltage category (EN 62109): Class III
- screw contacts: max. 2.5 mm²
- device with a contact gap of at least 3mm
- in accordance with the EN 60950-1 and LVD & EMC directives

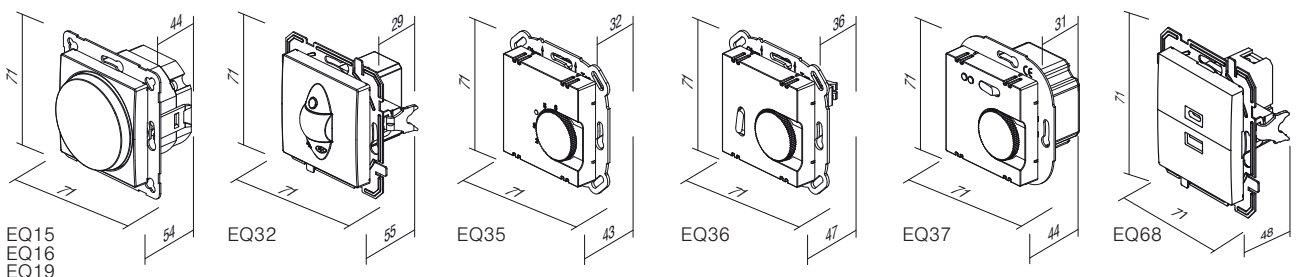

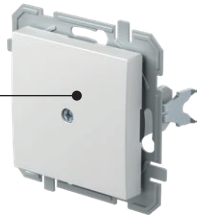

PQ10

PW

XO

Typ type	Bezeichnung description	Farbe colour	Optionsbezeichnung 1 optional data 1
PQ10	BLLENDE BLANK	□ PW weiß-glänzend polar white	XO ohne Rahmen without cover plate
PQ30	DECKEL TAE/TDO COVER TAE/TDO	■ TI titan titanium ■ AT anthrazit anthracite	

BLLENDE



- PQ10PWXO
- PQ10TIXO
- PQ10ATXO

- zum Abdecken von leeren Öffnungen

BLANK

- for filling up empty spaces



DECKEL TAE/TDO

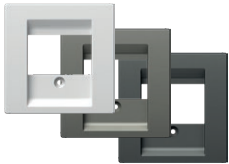

- PQ30PW
- PQ30TI
- PQ30AT

- TAE- oder TDO-Deckel mit Schraube

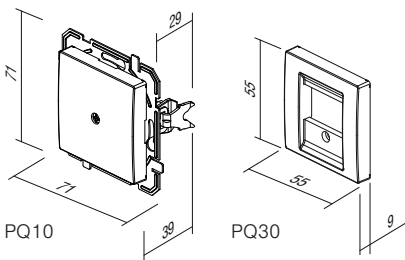

COVER TAE/TDO

- TAE or TDO cover with screw



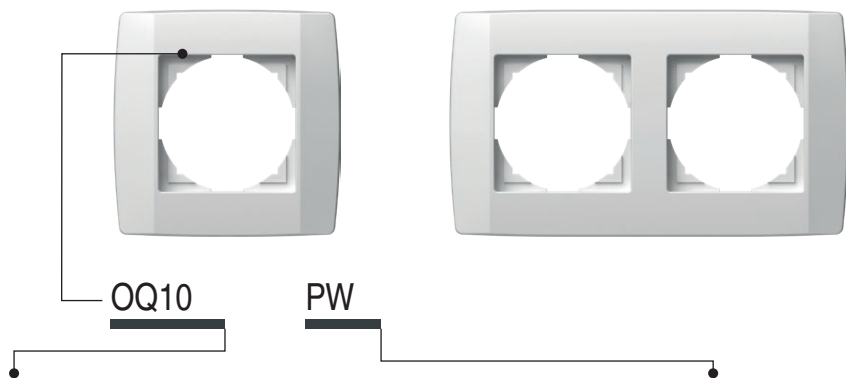

C O V E R P L A T E S O Q







Typ type	Bezeichnung description	Farbe colour
OQ10	RAHMEN LOGIQ 1 COVER PLATE LOGIQ 1	 PW weiß-glänzend polar white
OQ20	RAHMEN LOGIQ 2 COVER PLATE LOGIQ 2	 TI titan titanium
OQ30	RAHMEN LOGIQ 3 COVER PLATE LOGIQ 3	 AT anthrazit anthracite
:	:	
:	:	

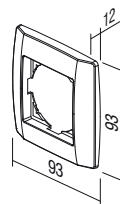

-  OQ10PW
-  OQ10TI
-  OQ10AT

RAHMEN LOGIQ 1
 - dekorativer Rahmen 1-fach
 - entspricht EN 60669-1
COVER PLATE LOGIQ 1
 - decorative cover plate 1-gang
 - in accordance with EN 60669-1



-  OQ20PW
-  OQ20TI
-  OQ20AT

RAHMEN LOGIQ 2
 - dekorativer Rahmen 2-fach
 - entspricht EN 60669-1
COVER PLATE LOGIQ 2
 - decorative cover plate 2-gang
 - in accordance with EN 60669-1

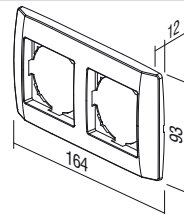

RAHMEN LOGIQ 3



- OQ30PW
- OQ30TI
- OQ30AT

- dekorativer Rahmen 3-fach
- entspricht EN 60669-1

COVER PLATE LOGIQ 3
 - decorative cover plate 3-gang
 - in accordance with EN 60669-1

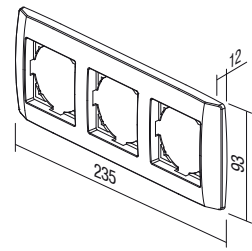

RAHMEN LOGIQ 4



- OQ40PW
- OQ40TI
- OQ40AT

- dekorativer Rahmen 4-fach
- entspricht EN 60669-1

COVER PLATE LOGIQ 4
 - decorative cover plate 4-gang
 - in accordance with EN 60669-1

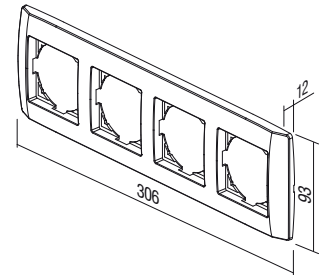

RAHMEN LOGIQ 5



- OQ50PW
- OQ50TI
- OQ50AT

- dekorative Rahmen 5-fach
- entspricht EN 60669-1

COVER PLATE LOGIQ 5
 - decorative cover plate 5-gang
 - in accordance with EN 60669-1

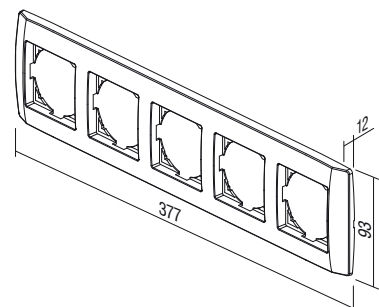

TEM

ekonomik





ekonomik

GEPLANTE PERFEKTION Stil ist das Wesentliche

Das neutrale, kompakte, elegante Design passt sich in jeder Umgebung an, in der Sie wohnen und arbeiten. Im Interieur tritt es nicht hervor, sondern lebt damit harmonisch auf.

PLANNED FOR EXCELLENCE Style is essential

A neutral, compact, elegant design is adjustable to every working or living area. It does not stick out from the interior, but rather harmonically fits into it.





ekonomik

HARMONIE DER FARBEN Wählen Sie Ihren Farbton

Wünsche können sehr unterschiedlich sein. Genau aus diesem Grund haben wir für Sie mit größter Sorgfalt verschiedene Möglichkeiten gewählt, die Ihnen die richtige Antwort anbieten. Die neutrale Farbpalette wird Ihr Ambiente ergänzen – und nicht begrenzen.

HARMONY OF COLOURS Choose your hue

Desires can be very different. Therefore we have carefully selected possibilities for you, which can offer you the right answer. A neutral palette of colours will only complement your ambient - it will not restrict it.

- | | | |
|-----------------------------|-------------------------|------------------------|
| <input type="checkbox"/> PW | Weiß glänzend | <i>polar white</i> |
| <input type="checkbox"/> IW | Beig -glänzend | <i>ivory white</i> |
| <input type="checkbox"/> ES | Silber matt | <i>elox silver</i> |
| <input type="checkbox"/> CO | Weiß, Duroplast | <i>white thermoset</i> |
| <input type="checkbox"/> NB | Schwarz glänzend | <i>night black</i> |





EINFACH FÜR DIE ANSPRUCHSVOLLSTEN

Wir haben mit einer sorgfältigen Planung dafür gesorgt, dass alle Elemente, die sich unter Spannung befinden, vor Berührung sicher sind. Die Grundbefestigung der Mechanismen mit Krallen (1) kann zusätzlich mit Schrauben (2) festgeschraubt werden. Diese Methode eignet sich vor allem für eine sichere und zuverlässige Befestigung der Steckdose.

SIMPLE FOR THE MOST DEMANDING

By careful planning elements under voltage have been protected against touching. Basic fixing of mechanisms with fixing claws (1) allows additional strengthening with screws (2). This manner is especially appropriate for safe and reliable fixing of sockets.

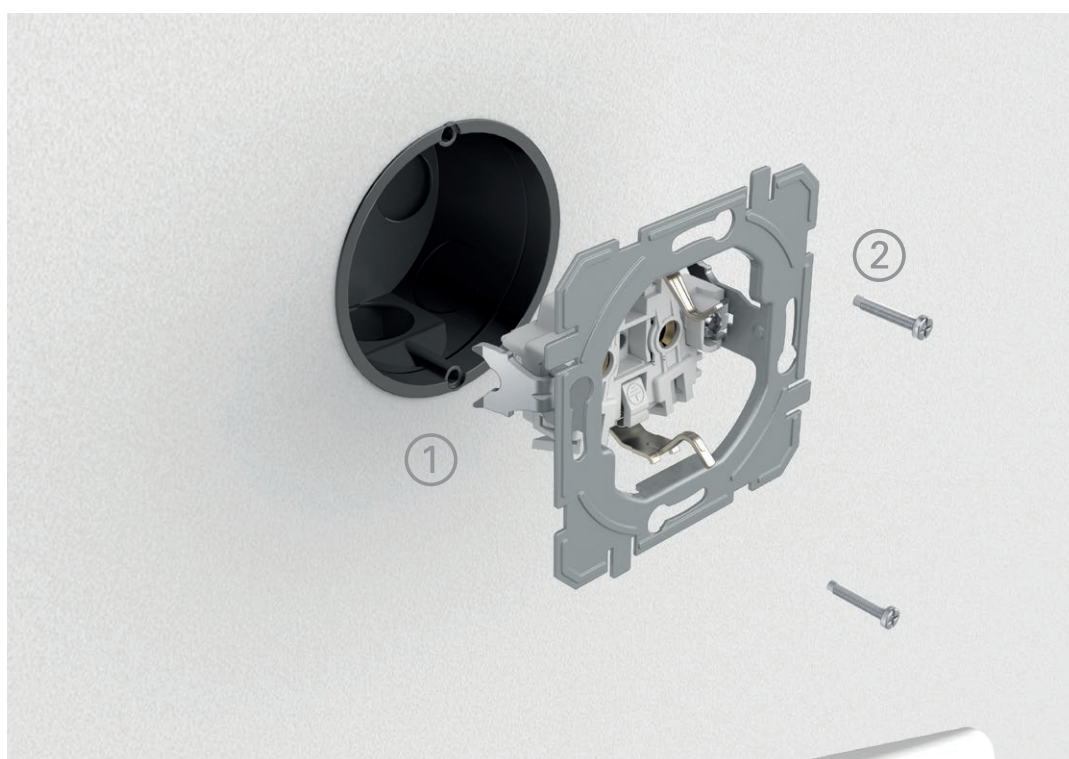

KOMBINIEREN SIE NACH LUST UND LAUNE.
COMBINE AS YOU PLEASE.

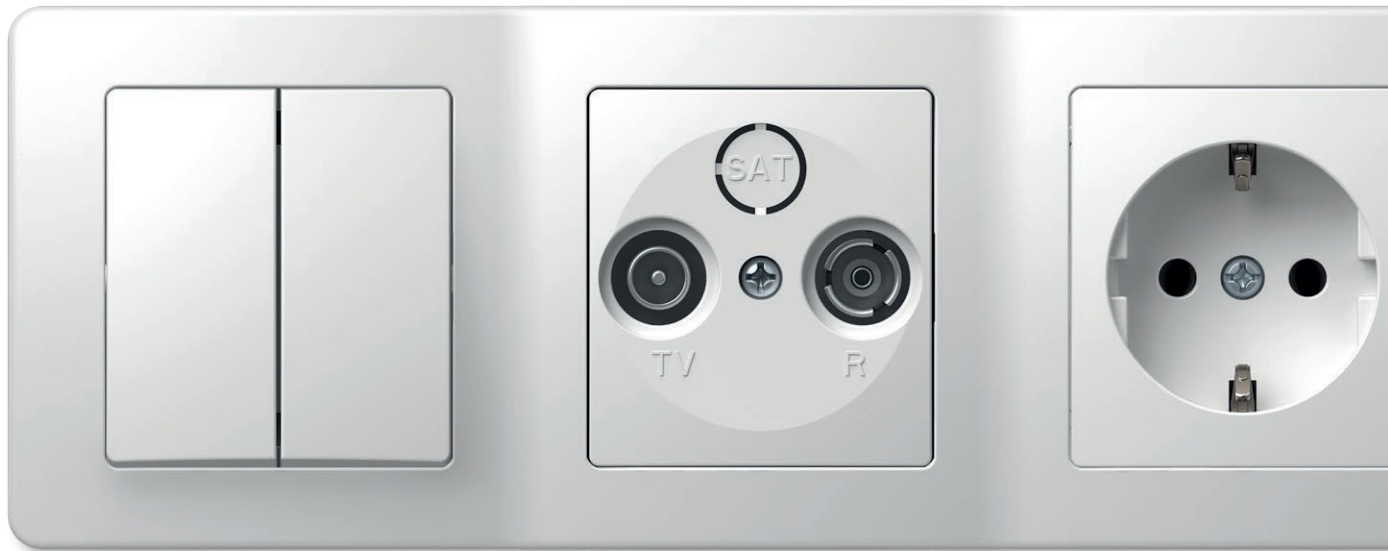

Mit verschiedenen Kombinationen können Sie Platz an der Wand sparen. Wenn wenig Platz vorhanden ist, dann ist die vertikale Entscheidung richtig.

With combining you save space on the wall. When faced with a limited space, »vertically« is the right decision.

EINFACHE MONTAGE

Ekonomik ist die Lösung für unser System der runden Standarddosen. Es ist für einfache wie auch anspruchsvollere Installationen, Neubauten und Umbauarbeiten geeignet. Das System zeichnet sich durch schraublose Kontakte aus, die Ihnen viel Zeit beim Einbau der Elemente ersparen.

EASY INSTALLATION

Ekonomik is a solution for the system of standardized round installations boxes. It can be used for simple as well as more demanding installations, new buildings and adaptations. The system is characterised by plug-in contacts which save time during installation of elements.

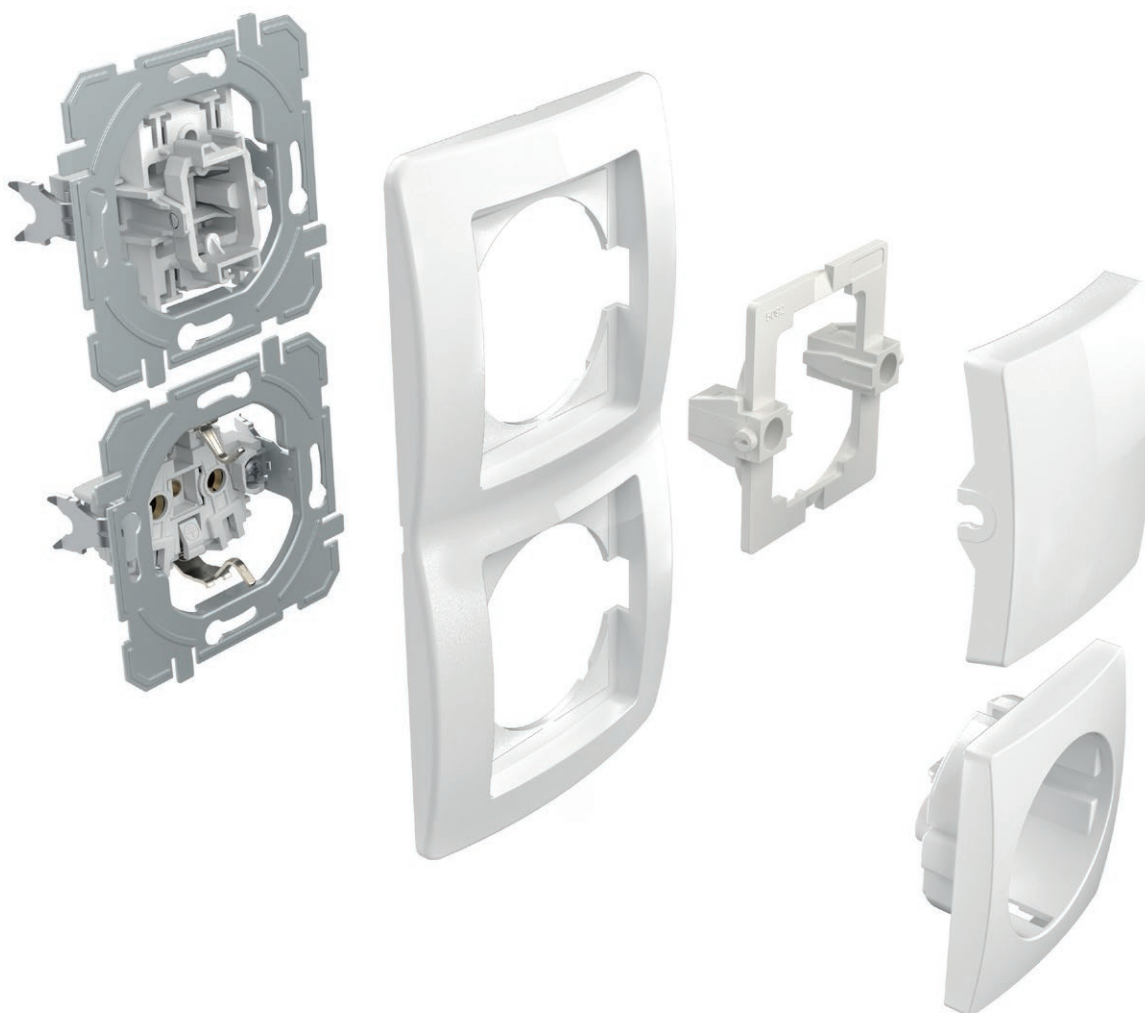

GUT ZU WISSEN

GOOD TO KNOW



Alle Steckdosen sind mit einem integrierten erhöhten Berührungsschutz ausgestattet.

All the sockets are equipped with a safety shutters assuring the protection to live contacts.



Die gut durchdachte Konstruktion des Schalters ermöglicht auch eine einfache nachträgliche Beleuchtung.

A well-planned switch construction makes easy illumination possible also subsequently.



Für eine zuverlässige Schaltung sorgen Kontakte aus einer Silberlegierung.

Contacts made of silver alloy guarantee safe switching.



Die schraubenlosen Kontakte ermöglichen einen schnellen und zuverlässigen Anschluss der Leitungen. An einem Kontakt können zwei Leitungen mit verschiedenen Durchmessern angeschlossen werden.

Plug-in contacts enable quick and reliable attachment of wires. Two wires of different diameters can be attached to the same contact.



Die Krallen ermöglichen eine tiefere Befestigung (auch an Fliesen usw.).







Fixing claws enable deeper fixing (also through ceramic tiles, etc.)

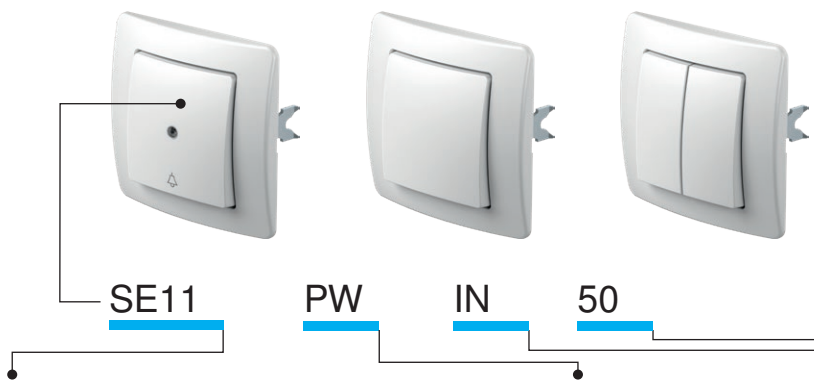

Erleichtern Sie sich die Arbeit mit schon zusammengesetzten Dosen, die Ihnen die richtigen Abstände gewährleisten.

Easy-fitting installation boxes will make your work easier. Proper lengths are guaranteed.



Typ type	Bezeichnung description	Technische Daten technical data	Farbe colour	Optionsbezeichnung 1 optional data 1	Optionsbezeichnung 2 optional data 2
SE10	SCHALTER 1-POLIG SWITCH 1WAY	10AX 250V~	<input type="checkbox"/> PW weiß-glänzend polar white	 NT neutral neutral	 50
SE11	TASTER 1-POLIG PUSH BUTTON 1WAY	10A 250V~	<input type="checkbox"/> IW beige-glänzend ivory white		 51
SE22	SCHALTER 2-POLIG SWITCH 2POLE	16AX 250V~	<input type="checkbox"/> ES silber-matt elox silver	 IN Indikator indicator	 03
...	<input type="checkbox"/> CO weiß, Duroplast white thermoset		 04
...	<input type="checkbox"/> NB schwarz-glänzend night black		...

SCHALTER 1-POLIG 10AX 250V~

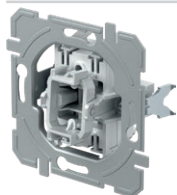

SE10

- 10AX 250V~, Typ SE10
 - entspricht EN 60669-1
 - Steckklemmen 1,5-2,5 mm²
- SWITCH 1WAY 10AX 250V~
- 10AX 250V~, type SE10
 - in accordance with EN 60669-1
 - plug-in contacts 1.5-2.5mm²

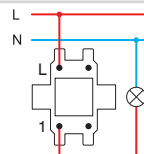

TASTER 1-POLIG 10A 250V~

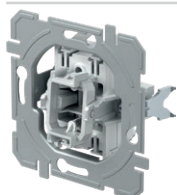

SE11

- 10A 250V~, Typ SE11
 - entspricht EN 60669-1
 - Steckklemmen 1,5-2,5 mm²
- PUSH BUTTON 1WAY 10A 250V~
- 10A 250V~, type SE11
 - in accordance with EN 60669-1
 - plug-in contacts 1.5-2.5mm²

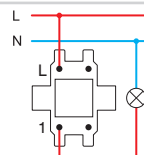

SCHALTER 2-POLIG 16AX 250V~

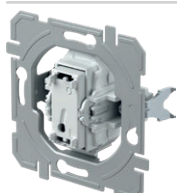

SE22

- 16AX 250V~, Typ SE22
 - entspricht EN 60669-1
 - Schraubklemmen 1,5-2.5mm²
 - Nur in Kombination mit Wippe TE10__NT03
- SWITCH 2POLE 16AX 250V~
- 16AX 250V~, type SE22
 - in accordance with EN 60669-1
 - screw contacts 1.5-2.5mm²
 - only in combination with button TE10__NT03

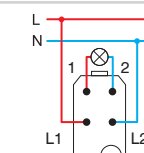
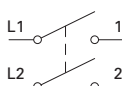

SCHALTER SERIEN 10AX 250V~

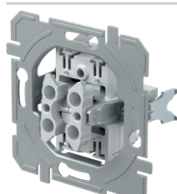

SE50

- 10AX 250V~, Typ SE50
 - entspricht EN 60669-1
 - Steckklemmen 1,5-2,5 mm²
- SWITCH 2GANG-1WAY 10AX 250V~
- 10AX 250V~, type SE50
 - in accordance with EN 60669-1
 - plug-in contacts 1.5-2.5mm²

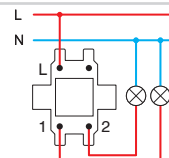
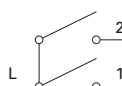

S W I T C H E S S E

TASTER SERIEN 10A 250V~

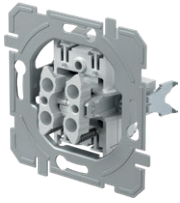

SE51

- 10A 250V~, Typ SE51
- entspricht EN 60669-1
- Steckklemmen 1,5–2,5 mm²

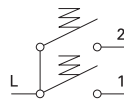

PUSH BUTTON 2GANG-1WAY 10A 250V~

- 10A 250V~, type SE51
- in accordance with EN 60669-1
- plug-in contacts 1.5-2.5mm²

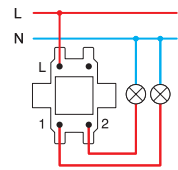

SCHALTER JALOUSIE 10AX 250V~

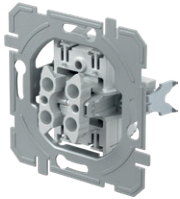

SE52

- 10AX 250V~, Typ SE52
- entspricht EN 60669-1
- Steckklemmen 1,5–2,5 mm²
- mit mechanischer Verriegelung

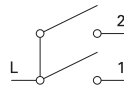

SWITCH SHUTTERS 10AX 250V~

- 10AX 250V~, type SE52
- in accordance with EN 60669-1
- plug-in contacts 1.5-2.5mm²
- with mechanical interblock

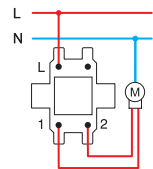

TASTER JALOUSIE 10A 250V~

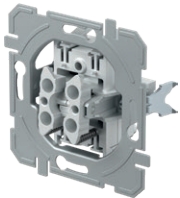

SE53

- 10A 250V~, Typ SE53
- entspricht EN 60669-1
- Steckklemmen 1,5–2,5 mm²
- mit mechanischer Verriegelung

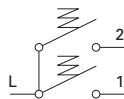

PUSH BUTTON SHUTTERS 10A 250V~

- 10A 250V~, type SE53
- in accordance with EN 60669-1
- plug-in contacts 1.5-2.5mm²
- with mechanical interblock

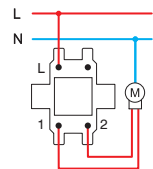

SCHALTER WECHSEL 10AX 250V~

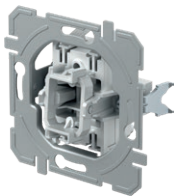

SE60

- 10AX 250V~, Typ SE60
- entspricht EN 60669-1
- Steckklemmen 1,5–2,5 mm²

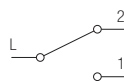

SWITCH 2WAY 10AX 250V~

- 10AX 250V~, type SE60
- in accordance with EN 60669-1
- plug-in contacts 1.5-2.5mm²

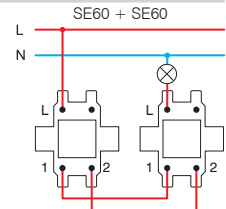

SCHALTER DOPPEL AUS/WECHSEL 10AX 250V~

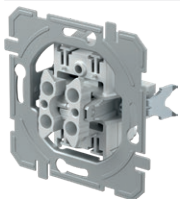

SE63

- 10AX 250V~, Typ SE63
- entspricht EN 60669-1
- Steckklemmen 1,5–2,5 mm²



SWITCH DOUBLE 2WAY 10AX 250V~

- 10AX 250V~, type SE63
- in accordance with EN 60669-1
- plug-in contacts 1.5-2.5mm²

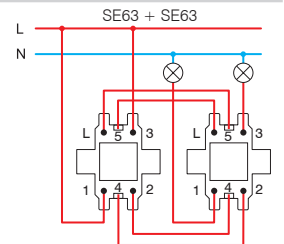

SCHALTER KREUZ 10AX 250V~

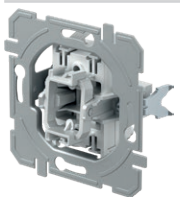

SE70

- 10AX 250V~, Typ SE70
- entspricht EN 60669-1
- Steckklemmen 1,5–2,5 mm²



SWITCH INTERMEDIATE 10AX 250V~

- 10AX 250V~, type SE70
- in accordance with EN 60669-1
- plug-in contacts 1.5-2.5mm²

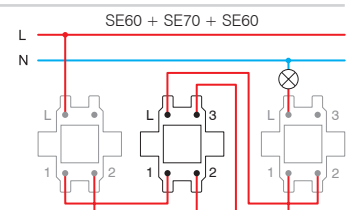

SCHALTER 1-POLIG 10AX 250V~



- SE10PW
- SE10IW
- SE10ES
- SE10CO
- SE10NB

- 10AX 250V~, Typ SE10
 - entspricht EN 60669-1
 - Steckklemmen 1,5-2,5 mm²

SWITCH 1WAY 10AX 250V~
 - 10AX 250V~, type SE10
 - in accordance with EN 60669-1
 - plug-in contacts 1.5-2.5mm²



SCHALTER 1-POLIG 10AX 250V~ __ IN



- SE10PWIN
- SE10IWIN
- SE10ESIN
- SE10COIN
- SE10NBIN

- IN Indikator
 - 10AX 250V~, Typ SE10
 - entspricht EN 60669-1
 - Steckklemmen 1,5-2,5 mm²

SWITCH 1WAY 10AX 250V~ __ IN
 - IN indicator
 - 10AX 250V~, type SE10
 - in accordance with EN 60669-1
 - plug-in contacts 1.5-2.5mm²



TASTER 1-POLIG 10A 250V~



- SE11PW
- SE11IW
- SE11ES
- SE11CO
- SE11NB

- 10A 250V~, Typ SE11
 - entspricht EN 60669-1
 - Steckklemmen 1,5-2,5 mm²

PUSH BUTTON 1WAY 10A 250V~
 - 10A 250V~, type SE11
 - in accordance with EN 60669-1
 - plug-in contacts 1.5-2.5mm²



TASTER 1-POLIG 10A 250V~ __ TI 50



- SE11PWTI50
- SE11IWTI50
- SE11ESTI50
- SE11COTI50
- SE11NBTI50

- TI 50 Indikator Klingel + Glühlampe
 - 10A 250V~, Typ SE11
 - entspricht EN 60669-1
 - Steckklemmen 1,5-2,5 mm²

PUSH BUTTON 1WAY 10A 250V~ __ TI 50
 - TI 50 indicator bell+neon lamp
 - 10A 250V~, type SE11
 - in accordance with EN 60669-1
 - plug-in contacts 1.5-2.5mm²



TASTER 1-POLIG 10A 250V~ __ TI 51



- SE11PWTI51
- SE11IWTI51
- SE11ESTI51
- SE11COTI51
- SE11NBTI51

- TI 51 Indikator Lampe + Glühlampe
 - 10A 250V~, Typ SE11
 - entspricht EN 60669-1
 - Steckklemmen 1,5-2,5 mm²

PUSH BUTTON 1WAY 10A 250V~ __ TI 51
 - TI 51 indicator light+neon lamp
 - 10A 250V~, type SE11
 - in accordance with EN 60669-1
 - plug-in contacts 1.5-2.5mm²



TASTER 1-POLIG 10A 250V~ __ IL



- SE11PWIL
- SE11IWIL
- SE11ESIL
- SE11COIL
- SE11NBIL

- IL mit Namensschild
 - 10A 250V~, Typ SE11
 - entspricht EN 60669-1
 - Steckklemmen 1,5-2,5 mm²

PUSH BUTTON 1WAY 10A 250V~ __ IL
 - IL inscription plate
 - 10A 250V~, type SE11
 - in accordance with EN 60669-1
 - plug-in contacts 1.5-2.5mm²



SCHALTER 2-POLIG 16AX 250V~ __ IN 03



- SE22PWIN03
- SE22IWIN03
- SE22ESIN03
- SE22NBIN03

- IN 03 neutral 0-1
 - 16AX 250V~, Typ SE22
 - entspricht EN 60669-1
 - Steckklemmen 1,5-2,5 mm²

SWITCH 2POLE 16AX 250V~ __ IN 03
 - IN 03 neutral 0-1
 - 16AX 250V~, type SE22
 - in accordance with EN 60669-1
 - screw contacts 1.5-2.5mm²



S W I T C H E S S E

	<ul style="list-style-type: none"> <input type="checkbox"/> SE50PW <input type="checkbox"/> SE50IW <input type="checkbox"/> SE50ES <input type="checkbox"/> SE50CO <input type="checkbox"/> SE50NB 	SCHALTER SERIEN 10AX 250V~	<ul style="list-style-type: none"> - 10AX 250V~, Typ SE50 - entspricht EN 60669-1 - Steckklemmen 1,5-2,5 mm² 	
	<ul style="list-style-type: none"> <input type="checkbox"/> SE51PW <input type="checkbox"/> SE51IW <input type="checkbox"/> SE51ES <input type="checkbox"/> SE51CO <input type="checkbox"/> SE51NB 	TASTER SERIEN 10A 250V~	<ul style="list-style-type: none"> - 10A 250V~, Typ SE51 - entspricht EN 60669-1 - Steckklemmen 1,5-2,5 mm² 	
	<ul style="list-style-type: none"> <input type="checkbox"/> SE52PWNT09 <input type="checkbox"/> SE52IWNT09 <input type="checkbox"/> SE52ESNT09 <input type="checkbox"/> SE52CONT09 <input type="checkbox"/> SE52NBNT09 	SCHALTER JALOUSIE 10AX 250V~ __ NT 09	<ul style="list-style-type: none"> - NT 09 neutral aufwärts-abwärts - 10AX 250V~, Typ SE52 - entspricht EN 60669-1 - Steckklemmen 1,5-2,5 mm² - mit mechanischer Verriegelung 	
	<ul style="list-style-type: none"> <input type="checkbox"/> SE53PWNT09 <input type="checkbox"/> SE53IWNT09 <input type="checkbox"/> SE53ESNT09 <input type="checkbox"/> SE53CONT09 <input type="checkbox"/> SE53NBNT09 	TASTER JALOUSIE 10A 250V~ __ NT 09	<ul style="list-style-type: none"> - NT 09 neutral aufwärts-abwärts - 10A 250V~, Typ SE53 - entspricht EN 60669-1 - Steckklemmen 1,5-2,5 mm² - mit mechanischer Verriegelung 	
	<ul style="list-style-type: none"> <input type="checkbox"/> SE60PW <input type="checkbox"/> SE60IW <input type="checkbox"/> SE60ES <input type="checkbox"/> SE60CO <input type="checkbox"/> SE60NB 	SCHALTER WECHSEL 10AX 250V~	<ul style="list-style-type: none"> - 10AX 250V~, Typ SE60 - entspricht EN 60669-1 - Steckklemmen 1,5-2,5 mm² 	
	<ul style="list-style-type: none"> <input type="checkbox"/> SE63PW <input type="checkbox"/> SE63IW <input type="checkbox"/> SE63ES <input type="checkbox"/> SE63CO <input type="checkbox"/> SE63NB 	SCHALTER DOPPEL AUS/WECHSEL 10AX 250V~	<ul style="list-style-type: none"> - 10AX 250V~, Typ SE63 - entspricht EN 60669-1 - Steckklemmen 1,5-2,5 mm² 	
	<ul style="list-style-type: none"> <input type="checkbox"/> SE70PW <input type="checkbox"/> SE70IW <input type="checkbox"/> SE70ES <input type="checkbox"/> SE70CO <input type="checkbox"/> SE70NB 	SCHALTER KREUZ 10AX 250V~	<ul style="list-style-type: none"> - 10AX 250V~, Typ SE70 - entspricht EN 60669-1 - Steckklemmen 1,5-2,5 mm² 	

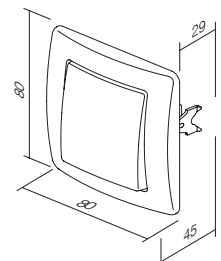
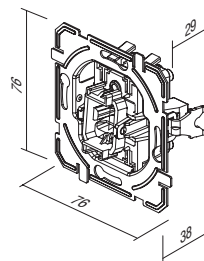



TE11

PW

NT

09

Typ type	Bezeichnung description	Farbe colour	Optionsbezeichnung 1 optional data 1	Optionsbezeichnung 2 optional data 2
TE10	WIPPE NORMAL BUTTON 1GANG	<input type="checkbox"/> PW weiß-glänzend polar white	NT neutral neutral	50
TE11	WIPPE SERIEN BUTTON 2GANG	<input type="checkbox"/> IW beige-glänzend ivory white	IN Indikator indicator	51
...	...	<input type="checkbox"/> ES silber-matt elox silver		03
...	...	<input type="checkbox"/> CO weiß, Duroplast white thermoset		04
...	...	<input type="checkbox"/> NB schwarz-glänzend night black		

WIPPE NORMAL



- TE10PW
- TE10IW
- TE10ES
- TE10CO
- TE10NB

- Wippe mit Wippenträger
BUTTON 1GANG
- button together with carrier



WIPPE MIT INDIKATOR

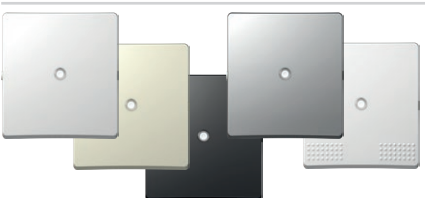

- TE10PWIN
- TE10IWIN
- TE10ESIN
- TE10COIN
- TE10NBIN

- Wippe mit Wippenträger
BUTTON INDICATOR
- button together with carrier



WIPPE MIT NAMENSSCHILD

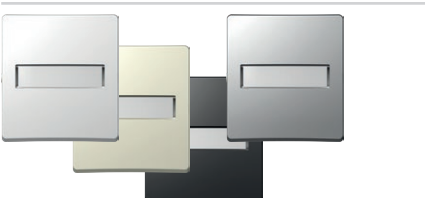

- TE13PWIL
- TE13IWIL
- TE13ESIL
- TE13NBIL

- Wippe mit Wippenträger und Namensschild
BUTTON WITH INSCRIPTION PLATE
- button together with carrier, with inscription plate



WIPPE SERIEN



- TE11PW
- TE11IW
- TE11ES
- TE11CO
- TE11NB

- Wippe serien mit Wippenträger
BUTTON 2GANG
- button 2gang together with carrier

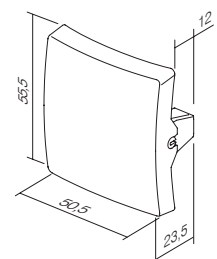
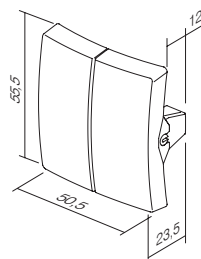

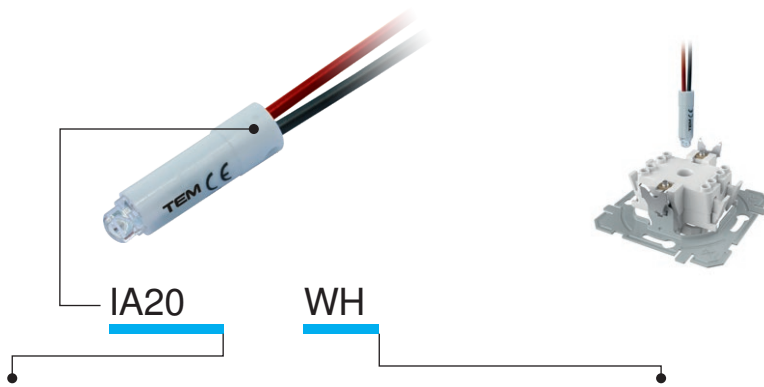

Typ type	Bezeichnung description	Technische Daten technical data	Farbe colour
IA10	GLÜHLAMPE NEON LAMP	230V~ 0,34W	<input type="checkbox"/> WH weiß white
IA20	LED-LAMPE LED LAMP	230V~ 0,40W	<input checked="" type="checkbox"/> BL blau blue
IA21	LED-LAMPE LED LAMP	24V AC/DC 0,20W	<input checked="" type="checkbox"/> RD rot red
⋮	⋮	⋮	<input checked="" type="checkbox"/> GR grün green
⋮	⋮	⋮	<input checked="" type="checkbox"/> OR orange orange

GLÜHLAMPE 230V~ 0,34 W

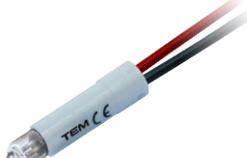

IA10OR

- zur Kontrollbeleuchtung, Beleuchtung oder ständige Beleuchtung des Schalters
- in Kombination mit Wippe mit einem Indikator

NEON LAMP 230V~ 0,34W

- for indication, illumination or constant illumination of switch
- in combination with button with indicator

LED-LAMPE 230V AC/DC 0,40 W



IA20WH
 IA20GR
 IA20RD
 IA20BL

- zur Kontrollbeleuchtung, Beleuchtung oder ständige Beleuchtung des Schalters
- in Kombination mit Wippe mit einem Indikator

LED LAMP 230V AC/DC 0,40W

- for indication, illumination or constant illumination of switch
- in combination with button with indicator

LED-LAMPE 24V AC/DC 0,20W

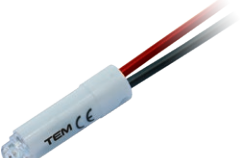

IA21WH
 IA21RD

- zur Kontrollbeleuchtung, Beleuchtung oder ständige Beleuchtung des Schalters
- in Kombination mit Wippe mit einem Indikator

LED LAMP 24V AC/DC 0,20W

- for indication, illumination or constant illumination of switch
- in combination with button with indicator

LED-LAMPE 12V AC/DC 0,10W



IA22WH
 IA22RD

- zur Kontrollbeleuchtung, Beleuchtung oder ständige Beleuchtung des Schalters
- in Kombination mit Wippe mit einem Indikator

LED LAMP 12V AC/DC 0,10W

- for indication, illumination or constant illumination of switch
- in combination with button with indicator

Kontrollbeleuchtung /
Indication

* Beleuchtung /
Illumination

Ständige Beleuchtung /
Illumination always on

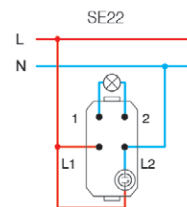
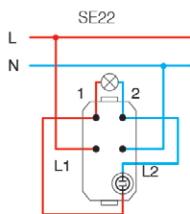
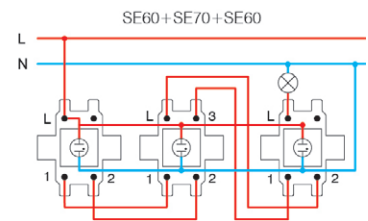
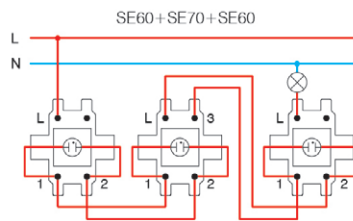
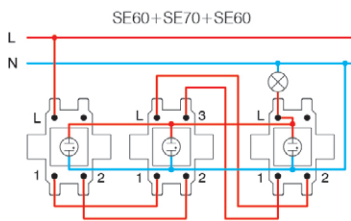
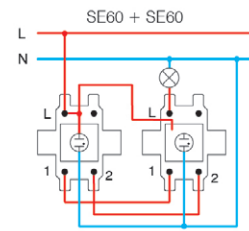
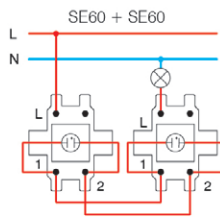
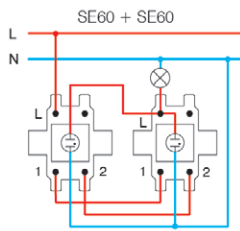
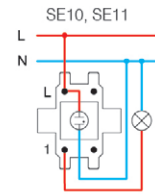
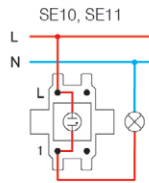
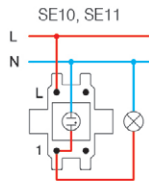

* die Schaltungen sind nicht geeignet für Sparlampen (CFL, LED) /
the connections are not suitable for energy-saving bulbs (CFL, LED)

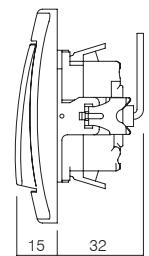

S O C K E T S V E

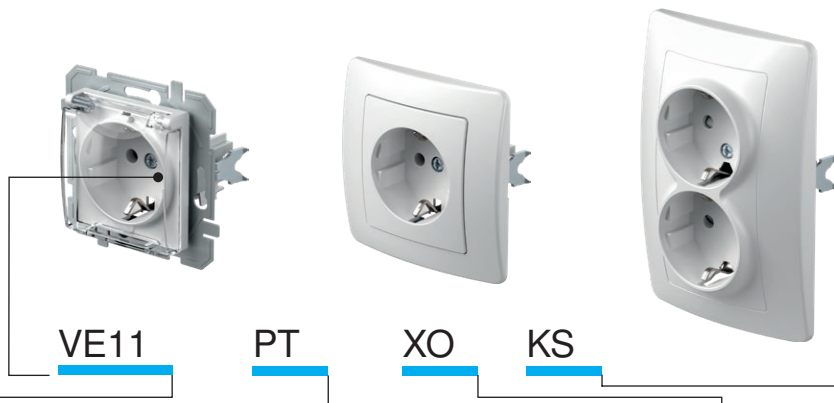

Typ type	Bezeichnung description	Technische Daten technical data	Optionsbezeichnung 1 optional data 1	Optionsbezeichnung 2 optional data 2
VE10	STECKDOSE SCHUKO SOCKET SCHUKO	2P+E 16A 250V~	XO ohne Rahmen without cover plate	KS Steckdose mit erhöhtem Berührungsschutz shuttered live contacts
VE11	STECKDOSE SCHUKO+KLAPPDECKEL SOCKET SCHUKO+COVER	2P+E 16A 250V~		
VE12	STECKDOSE SCHUKO SOCKET SCHUKO	2P+E 16A 250V~ BV	KS Steckdose mit erhöhtem Berührungsschutz shuttered live contacts	
⋮	⋮	⋮		

Farbe
colour

<input type="checkbox"/> PW weiß-glänzend polar white	<input checked="" type="checkbox"/> PT weiß + transparent white+transparent	<input type="checkbox"/> PP weiß + weiß white+white
<input checked="" type="checkbox"/> IW beige-glänzend ivory white	<input checked="" type="checkbox"/> IT beige + transparent ivory+transparent	<input checked="" type="checkbox"/> II beige + beige ivory+ivory
<input type="checkbox"/> ES silber-matt elox silver	<input checked="" type="checkbox"/> ST silber + transparent silver+transparent	<input type="checkbox"/> SS silber + silber silver+silver
<input type="checkbox"/> CO weiß, Duroplast white thermoset	<input type="checkbox"/> CT weiß + transparent white+transparent	<input checked="" type="checkbox"/> BB schwarz + schwarz black+black
<input checked="" type="checkbox"/> NB schwarz-glänzend night black	<input checked="" type="checkbox"/> BT schwarz + transparent black+transparent	<input checked="" type="checkbox"/> RR rot + rot red+red
<input checked="" type="checkbox"/> RD rot red	<input checked="" type="checkbox"/> RT rot + transparent red+transparent	<input checked="" type="checkbox"/> GG grün + grün green+green
<input checked="" type="checkbox"/> GR grün green	<input checked="" type="checkbox"/> GT grün + transparent green+transparent	<input checked="" type="checkbox"/> OO orange + orange orange+orange
<input checked="" type="checkbox"/> OR orange orange	<input checked="" type="checkbox"/> OT orange + transparent orange+transparent	



Schuko – entspricht EN 60884-1, CEE7 (Blatt III)

Französisch - entspricht NF C 61-314 (Blatt V)

schuko - in accordance with EN 60884-1, CEE7 (standard sheet III)

French - in accordance with NF C 61-314 (standard sheet V)

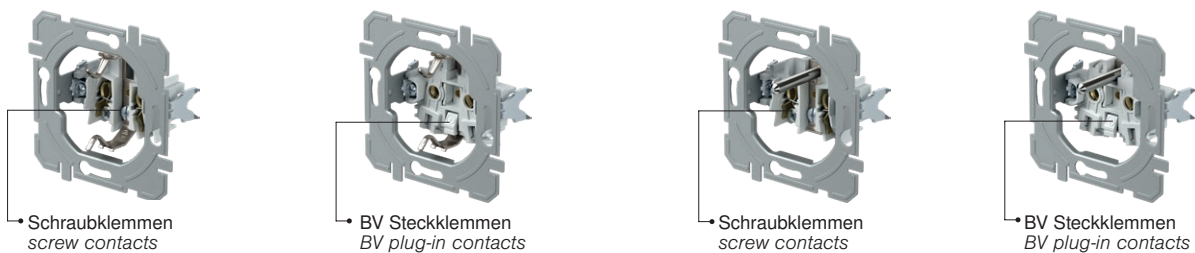

STECKDOSE SCHUKO 2P+E 16A 250V~ __ XO



- VE10PWXO
- VE10IWXO
- VE10ESXO
- VE10COXO
- VE10NBXO
- VE10RDXO
- VE10GRXO
- VE10ORXO

- Schraubklemmen 1,5–2,5 mm²
- XO ohne Rahmen
- Steckdose mit Schutzkontakt
- 16A 250V~, Typ VE10

SOCKET SCHUKO 2P+E 16A 250V~ __ XO

- screw contacts 1.5-2.5mm²
- XO without surround
- 2P+E schuko
- 16A 250V~, type VE10



STECKDOSE SCHUKO+DECKEL 2P+E 16A 250V~ __ XO

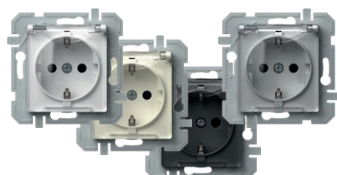

- VE11PTXO
- VE11ITXO
- VE11STXO
- VE11BTXO

- Schraubklemmen 1,5–2,5 mm²
- XO ohne Rahmen
- Steckdose mit Schutzkontakt mit Klappdeckel
- 16A 250V~, Typ VE11

SOCKET SCHUKO+COVER 2P+E 16A 250V~ __ XO

- screw contacts 1.5-2.5mm²
- XO without surround
- 2P+E schuko+cover
- 16A 250V~, type VE11



STECKDOSE SCHUKO 2P+E 16A 250V~ BV_XO



- VE12PWXO
- VE12IWXO
- VE12ESXO
- VE12COXO
- VE12NBXO
- VE12RDXO
- VE12GRXO
- VE12ORXO

- BV – Steckklemmen 1,5–2,5 mm²
- XO ohne Rahmen
- Steckdose mit Schutzkontakt
- 16A 250V~, Typ VE12

SOCKET SCHUKO 2P+E 16A 250V~ BV __ XO

- BV plug-in contacts 1.5-2.5mm²
- XO without surround
- 2P+E schuko
- 16A 250V~, type VE12



STECKDOSE SCHUKO+KLAPPDECKEL 2P+E 16A 250V~ BV __ XO



- VE13PTXO
- VE13ITXO
- VE13STXO
- VE13BTXO
- VE13PPXO

- BV – Steckklemmen 1,5–2,5 mm²
- XO ohne Rahmen
- Steckdose mit Schutzkontakt mit Klappdeckel
- 16A 250V~, Typ VE13

SOCKET SCHUKO+COVER 2P+E 16A 250V~ BV __ XO

- BV plug-in contacts 1.5-2.5mm²
- XO without surround
- 2P+E schuko+cover
- 16A 250V~, type VE13



STECKDOSE SCHUKO 2P+E 16A 250V~



- VE10PW
- VE10IW
- VE10ES
- VE10CO
- VE10NB

- Schraubklemmen 1,5–2,5 mm²
- Steckdose mit Schutzkontakt
- 16A 250V~, Typ VE10

SOCKET SCHUKO 2P+E 16A 250V~

- screw contacts 1.5-2.5mm²
- 2P+E schuko
- 16A 250V~, type VE10



STECKDOSE SCHUKO+KLAPPDECKEL 2P+E 16A 250V~



- VE11PT
- VE11IT
- VE11ST
- VE11CT
- VE11BT

- Schraubklemmen 1,5–2,5 mm²
- Steckdose mit Schutzkontakt mit Klappdeckel
- 16A 250V~, Typ VE11

SOCKET SCHUKO+COVER 2P+E 16A 250V~

- screw contacts 1.5-2.5mm²
- 2P+E schuko+cover
- 16A 250V~, type VE11



STECKDOSE SCHUKO 2P+E 16A 250V~ BV



- VE12PW
- VE12IW
- VE12ES
- VE12CO
- VE12NB

- BV – Steckklemmen 1,5–2,5 mm²
- Steckdose mit Schutzkontakt
- 16A 250V~, Typ VE12

SOCKET SCHUKO 2P+E 16A 250V~ BV

- BV plug-in contacts 1.5-2.5mm²
- 2P+E schuko
- 16A 250V~, type VE12



STECKDOSE SCHUKO+KLAPPDECKEL 2P+E 16A 250V~ BV



- VE13PT
- VE13IT
- VE13ST
- VE13CT
- VE13BT

- BV – Steckklemmen 1,5–2,5 mm²
- Steckdose mit Schutzkontakt mit Klappdeckel
- 16A 250V~, Typ VE13

SOCKET SCHUKO+COVER 2P+E 16A 250V~ BV

- BV plug-in contacts 1.5-2.5mm²
- 2P+E schuko+cover
- 16A 250V~, type VE13



STECKDOSE FRANZÖSISCH 2P+E 16A 250V~ __ XO

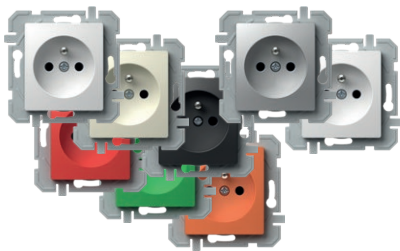

- VE40PWXO
- VE40IWXO
- VE40ESXO
- VE40COXO
- VE40NBXO
- VE40RDXO
- VE40GRXO
- VE40ORXO

- Schraubklemmen 1,5–2,5 mm²
- XO ohne Rahmen
- Steckdose mit Schutzkontakt, französischer Standard
- 16A 250V~, Typ VE40

SOCKET FRENCH 2P+E 16A 250V~ __ XO

- screw contacts 1.5-2.5mm²
- XO without surround
- 2P+E French
- 16A 250V~, type VE40



STECKDOSE FRANZÖSISCH+KLAPPDECKEL 2P+E 16A 250V~ __ XO



- VE41PTXO
- VE41ITXO
- VE41STXO
- VE41PTXO
- VE41BTXO
- VE41PPXO

- Schraubklemmen 1,5–2,5 mm²
- XO ohne Rahmen
- Steckdose mit Schutzkontakt mit Klappdeckel, französischer Standard
- 16A 250V~, Typ VE41

SOCKET FRENCH+COVER 2P+E 16A 250V~ __ XO

- screw contacts 1.5-2.5mm²
- XO without surround
- 2P+E French+cover
- 16A 250V~, type VE41



STECKDOSE FRANZÖSISCH 2P+E 16A 250V~ BV __ XO

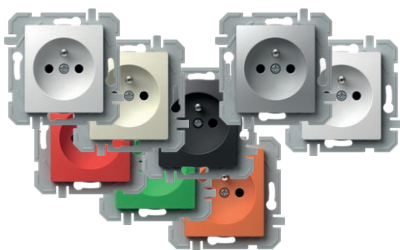

- VE42PWXO
- VE42IWXO
- VE42ESXO
- VE42COXO
- VE42NBXO
- VE42RDXO
- VE42GRXO
- VE42ORXO

- BV – Steckklemmen 1,5–2,5 mm²
- XO ohne Rahmen
- Steckdose mit Schutzkontakt, französischer Standard
- 16A 250V~, Typ VE42

SOCKET FRENCH 2P+E 16A 250V~ BV __ XO

- BV plug-in contacts 1.5-2.5mm²
- XO without surround
- 2P+E French
- 16A 250V~, type VE42



STECKDOSE FRANZÖSISCH+KLAPPDECKEL 2P+E 16A 250V~ BV __ XO

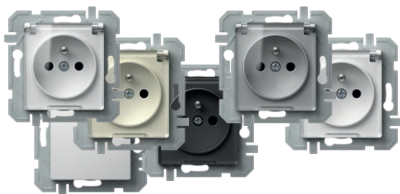

- VE43PTXO
- VE43ITXO
- VE43STXO
- VE43PTXO
- VE43BTXO
- VE43PPXO

- BV – Steckklemmen 1,5–2,5 mm²
- XO ohne Rahmen
- Steckdose mit Schutzkontakt mit Klappdeckel, französischer Standard
- 16A 250V~, Typ VE43

SOCKET FRENCH+COVER 2P+E 16A 250V~ BV __ XO

- BV plug-in contacts 1.5-2.5mm²
- XO without surround
- 2P+E French+cover
- 16A 250V~, type VE43



STECKDOSE FRANZÖSISCH 2P+E 16A 250V~



- VE40PW
- VE40IW
- VE40ES
- VE40CO
- VE40NB

- Schraubklemmen 1,5–2,5 mm²
- Steckdose mit Schutzkontakt, französischer Standard
- 16A 250V~, Typ VE40

SOCKET FRENCH 2P+E 16A 250V~

- screw contacts 1.5-2.5mm²
- 2P+E French
- 16A 250V~, type VE40



STECKDOSE FRANZÖSISCH+KLAPPDECKEL 2P+E 16A 250V~



- VE41PT
- VE41IT
- VE41BT
- VE41ST

- Schraubklemmen 1,5–2,5 mm²
- Steckdose mit Schutzkontakt mit Klappdeckel, französischer Standard
- 16A 250V~, Typ VE41

SOCKET FRENCH+COVER 2P+E 16A 250V~

- screw contacts 1.5-2.5mm²
- 2P+E French+cover
- 16A 250V~, type VE41



STECKDOSE FRANZÖSISCH 2P+E 16A 250V~ BV



- VE42PW
- VE42IW
- VE42ES
- VE42CO
- VE42NB

- BV – Steckklemmen 1,5–2,5 mm²
- Steckdose mit Schutzkontakt, französischer Standard
- 16A 250V~, Typ VE42

SOCKET FRENCH 2P+E 16A 250V~ BV

- BV plug-in contacts 1.5-2.5mm²
- 2P+E French
- 16A 250V~, type VE42



STECKDOSE FRANZÖSISCH+KS+KLAPPDECKEL 2P+E 16A 250V~ BV



- VE43PT
- VE43IT
- VE43BT
- VE43ST

- BV – Steckklemmen 1,5–2,5 mm²
- Steckdose mit Schutzkontakt mit Klappdeckel, französischer Standard
- 16A 250V~, Typ VE43

SOCKET FRENCH+COVER 2P+E 16A 250V~ BV

- BV plug-in contacts 1.5-2.5mm²
- 2P+E French+cover
- 16A 250V~, type VE43



STECKDOSE SCHUKO DOPPELT 2P+E 16A 250V~



- VE16PWKS
- VE16WKS
- VE16ESKS
- VE16NBKS

- Doppelsteckdose mit Schutzkontakt
- 16A 250V~, Typ VE16
- entspricht IEC 60884-1, CEE7
- Schraubklemmen 1,5-2,5 mm²
- KS mit erhöhtem Berührungsschutz

SOCKET SCHUKO DOUBLE 2P+E 16A 250V~

- 2P+E schuko double
- 16A 250V~, type VE16
- in accordance with IEC 60884-1, CEE7
- screw contacts 1.5-2.5 mm²
- KS shuttered live contacts



STECKDOSE FRANZÖSISCH DOPPELT 2P+E 16A 250V~



- VE46PWKS
- VE46WKS
- VE46ESKS
- VE46NBKS

- Doppelsteckdose mit Schutzkontakt, französischer Standard
- 16A 250V~, Typ VE46
- entspricht IEC 60884-1, CEE7; NF C 61-314, CSN 33 2318; PN-E 93201
- Schraubklemmen 1,5-2,5 mm²
- KS mit erhöhtem Berührungsschutz

SOCKET FRENCH DOUBLE 2P+E 16A 250V~

- 2P+E French double
- 16A 250V~, type VE46
- in accordance with IEC 60884-1, CEE7; NF C 61-314, CSN 33 2318; PN-E 93201
- screw contacts 1.5-2.5 mm²
- KS shuttered live contacts



STECKDOSE 2P 16A 250V~



- VE30PW
- VE30IW
- VE30ES
- VE30NB

- 2P ohne Erdungskontakt
- 16A 250V~
- entspricht EN 60884-1, CEE7 (Seite I)
- Schraubklemmen 1,5-2,5 mm²

SOCKET 2P 16A 250V~

- 2P without earthing contact
- 16A 250V~
- in accordance with EN 60884-1, CEE7 (standard sheet I)
- screw contacts 1.5-2.5mm²

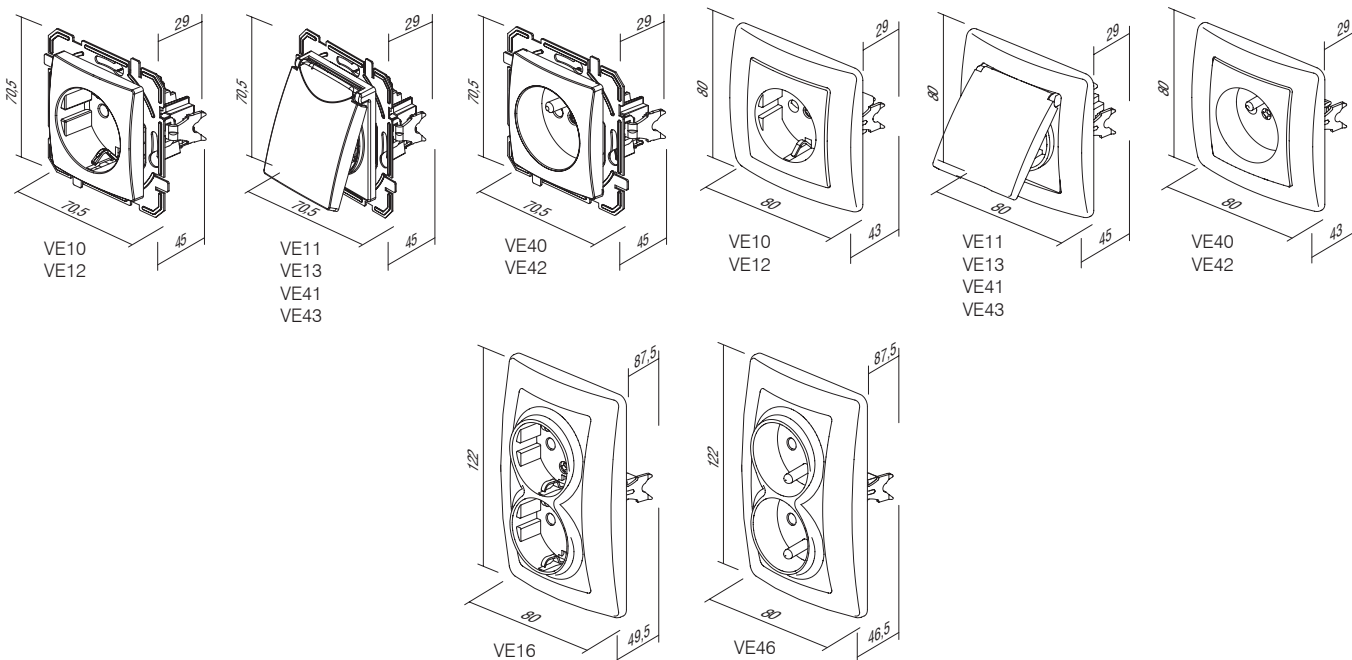



KE37

PW

Typ type	Bezeichnung description	Technische Daten technical data	Farbe colour
KE11	STECKDOSE TV-R ENDDOSE SOCKET TV-R END-LINE	1dB	<input type="checkbox"/> PW weiß-glänzend polar white
KE12	STECKDOSE TV-R DURCHGANGSDOSE SOCKET TV-R THROUGHPASS	0dB	<input type="checkbox"/> IW beige-glänzend ivory white
KE16	STECKDOSE SAT-TV-R ENDDOSE SOCKET SAT-TV-R END-LINE	3dB	<input type="checkbox"/> ES silber-matt elox silver
⋮	⋮	⋮	<input type="checkbox"/> CO weiß, Duroplast white thermoset
⋮	⋮	⋮	<input type="checkbox"/> NB schwarz-glänzend night black

STECKDOSE TV-R-ENDDOSE 1dB



KE11



- TV-R-Enddose
- Übertragungsbandbreite 5÷862 MHz
- Dämpfung: R-1,5 dB, TV-1 dB
- entspricht EN 50083-1
- Schraubklemmen

SOCKET TV-R END-LINE 1dB

- TV-R end-line
- frequency range 5÷862MHz
- reduction: R-1.5dB, TV-1dB
- in accordance with EN 50083-1
- screw contacts

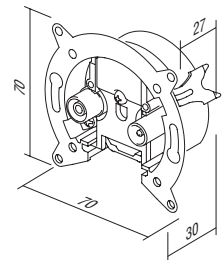

STECKDOSE TV-R-DURCHGANGSDOSE 10dB



KE12

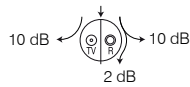

- TV-R Durchgangsdose
- Übertragungsbandbreite 5÷862 MHz
- Dämpfung: R-10 dB, TV-10 dB, Durchgang-2 dB
- entspricht EN 50083-1
- Schraubklemmen

SOCKET TV-R TROUGHPASS 10dB

- TV-R troughpass
- frequency range 5÷862MHz
- reduction: R-10dB, TV-10dB, trough-2dB
- in accordance with EN 50083-1
- screw contacts

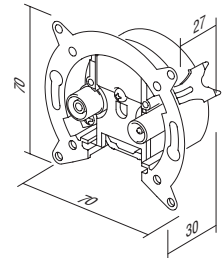

STECKDOSE SAT-TV-R-ENDDOSE 3dB



KE16

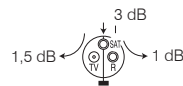

- SAT-TV-R-Enddose
- Übertragungsbandbreite 5÷2400 MHz
- Dämpfung: R-1 dB, TV-1,5 dB, SAT-3 dB
- Montage in der Wanddose Ø60 mit Krallen oder Schrauben
- entspricht EN 50083-1
- Schraubklemmen

SOCKET SAT-TV-R END-LINE 3dB

- SAT-TV-R end-line
- frequency range 5÷2400MHz
- reduction: R-1dB, TV-1.5dB, SAT-3dB
- for mounting in round box Ø60 with claws or screws
- in accordance with EN 50083-1
- screw contacts

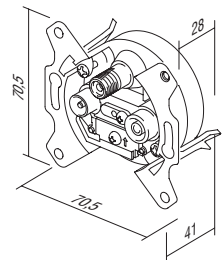

STECKDOSE TEL KS RJ11 6/4

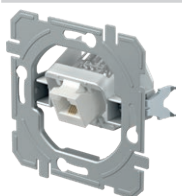

KE36

- KS – keystone-Befestigungsstandard
- RJ11 6/4
- entspricht IEC 60603-7

SOCKET TEL KS RJ11 6/4

- KS keystone fixing standard
- RJ11 6/4
- in accordance with IEC 60603-7

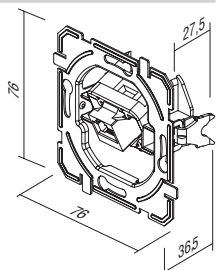

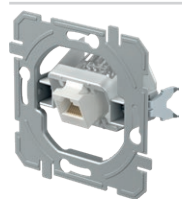

KE37

STECKDOSE CAT5e KS RJ45 8/8

- KS – keystone-Befestigungsstandard
- CAT5e, RJ45 8/8
- entspricht IEC 60603-7

SOCKET CAT5e KS RJ45 8/8

- KS keystone fixing standard
- CAT5e, RJ45 8/8
- in accordance with IEC 60603-7

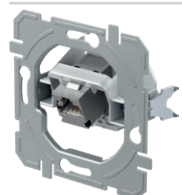
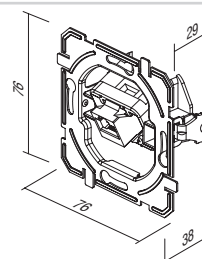

KE40

STECKDOSE CAT6s KS RJ45 8/8 SLIM

- KS – keystone-Befestigungsstandard
- CAT6s, RJ45 8/8
- entspricht IEC 60603-7

SOCKET CAT6s KS RJ45 8/8 SLIM

- KS keystone fixing standard
- CAT6s, RJ45 8/8
- in accordance with IEC 60603-7

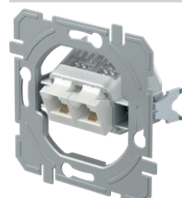
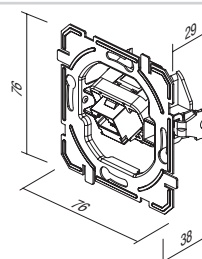

KE38

STECKDOSE TEL KS DOPPELT 2x RJ11 6/4

- KS – keystone-Befestigungsstandard
- 2x RJ11 6/4
- entspricht IEC 60603-7

SOCKET TEL KS DOUBLE 2x RJ11 6/4

- KS keystone fixing standard
- 2x RJ11 6/4
- in accordance with IEC 60603-7

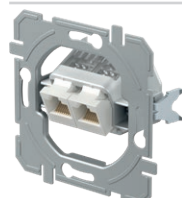
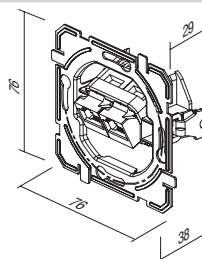

KE39

STECKDOSE CAT5e KS DOPPELT 2x RJ45 8/8

- KS – keystone-Befestigungsstandard
- 2x CAT5e, RJ45 8/8
- entspricht IEC 60603-7

SOCKET CAT5e KS DOUBLE 2x RJ45 8/8

- KS keystone fixing standard
- 2x CAT5e, RJ45 8/8
- in accordance with IEC 60603-7

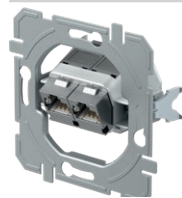
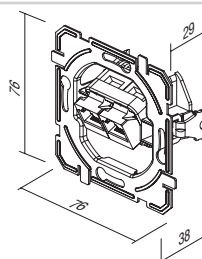

KE41

STECKDOSE CAT6s KS DOPPELT 2x RJ45 8/8 SLIM

- KS – keystone-Befestigungsstandard
- 2x CAT6s, RJ45 8/8
- entspricht IEC 60603-7

SOCKET CAT6s KS DOUBLE 2x RJ45 8/8 SLIM

- KS keystone fixing standard
- 2x CAT6s, RJ45 8/8
- in accordance with IEC 60603-7

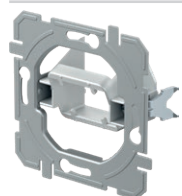
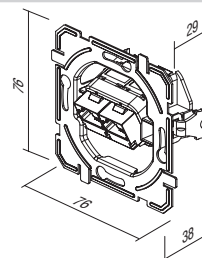

KE45

ADAPTER KS EINFACH

- KS – keystone-Befestigungsstandard – einfach
- AMP, Avaya, Brandrex, FMT, Mfico, Tyco, ...
- ohne Kommunikationsmodul

ADAPTER KS SINGLE

- KS keystone fixing standard - single
- AMP, Avaya, Brandrex, FMT, Mfico, Tyco, ...
- communication module not included

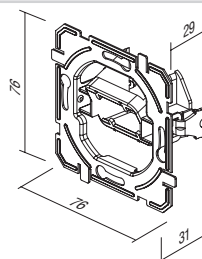

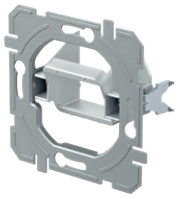

KE46

ADAPTER KS DOPPELT

- KS – keystone-Befestigungsstandard – doppelt
- AMP, Tyco, ...
- ohne Kommunikationsmodul

ADAPTER KS DOUBLE

- KS keystone fixing standard - double
- AMP, Tyco, ...
- communication module not included

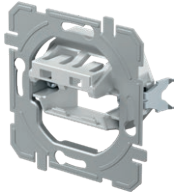
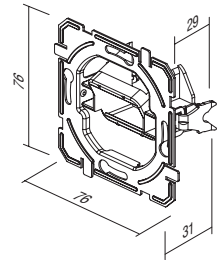

KE47

ADAPTER PD DOPPELT

- PD Panduit MiniCOM-Befestigungsstandard – doppelt
- ohne Kommunikationsmodul

ADAPTER PD DOUBLE

- PD Panduit Mini-COM fixing standard - double
- communication module not included

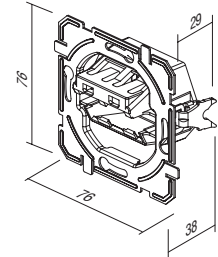

STECKDOSE TV-EINZELDOSE 0dB



- KE10PW
- KE10IW
- KE10ES
- KE10CO
- KE10NB

- TV-Einzeldose
- Dämpfung 0 dB
- Rückanschluss – F-Standard

SOCKET TV BASIC 0dB

- TV basic
- reduction 0dB
- back connector – F standard



STECKDOSE TV-R-ENDDOSE 1dB



- KE11PW
- KE11IW
- KE11ES
- KE11CO
- KE11NB

- TV-R-Enddose
- Übertragungsbandbreite 5÷862 MHz
- Dämpfung: R-1,5 dB, TV-1 dB
- entspricht EN 50083-1
- Schraubklemmen

SOCKET TV-R END-LINE 1dB

- TV-R end-line
- frequency range 5÷862 MHz
- reduction: R-1.5dB, TV-1dB
- in accordance with EN 50083-1
- screw contact



STECKDOSE TV-R-DURCHGANGSDOSE 10dB



- KE12PW
- KE12IW
- KE12ES
- KE12CO
- KE12NB

- TV-R-Durchgangsdose
- Übertragungsbandbreite 5÷862 MHz
- Dämpfung: R-10 dB, TV-10 dB, Durchgang-2 dB
- entspricht EN 50083-1
- Schraubklemmen

SOCKET TV-R TROUGH-PASS 10dB

- TV-R troughpass
- frequency range 5÷862 MHz
- reduction: R-10dB, TV-10dB, trough-2dB
- in accordance with EN 50083-1
- screw contacts



STECKDOSE SAT-TV-R-ENDDOSE 3dB



- KE16PW
- KE16IW
- KE16ES
- KE16CO
- KE16NB

- SAT-TV-R-Enddose
- Übertragungsbandbreite 5÷2400 MHz
- Dämpfung: R-1 dB, TV-1,5 dB, SAT-3 dB
- entspricht EN 50083-1
- Schraubklemmen

SOCKET SAT-TV-R END-LINE 3dB

- SAT-TV-R end-line
- frequency range 5÷2400 MHz
- reduction: R-1dB, TV-1.5dB, SAT-3dB
- in accordance with EN 50083-1
- screw contacts



STECKDOSE AUDIO 2xRCA



- KE22PW
- KE22IW
- KE22ES
- KE22CO
- KE22NB

- Audio 2xRCA
- gelöteter Kabelanschluss

SOCKET AUDIO 2xRCA

- audio 2xRCA
- soldering connection of cable



STECKDOSE AUDIO FÜR LAUTSPRECHER



- KE23PW
- KE23IW
- KE23ES
- KE23CO
- KE23NB

- Audio-Anschlussdose – 2x Ø4 mm
- Kabelanschluss für Lautsprecher, Stecker Ø4 mm oder Gabel-Kabelstecker
- gelöteter Kabelanschluss hinten

SOCKET AUDIO LOUDSPEAKERS

- audio 2x Ø4mm
- to accommodate speaker wire, banana plug Ø4mm or spades
- soldering connection of cable at the back side



STECKDOSE TEL KS RJ11 6/4

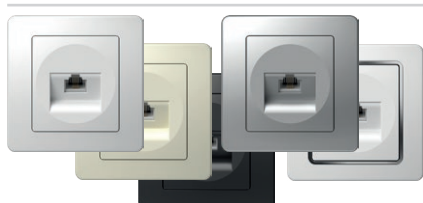

- KE36PW
- KE36IW
- KE36ES
- KE36CO
- KE36NB

- KS – keystone-Befestigungsstandard
- RJ11 6/4
- entspricht IEC 60603-7

SOCKET TEL KS RJ11 6/4

- KS keystone fixing standard
- RJ11 6/4
- in accordance with IEC 60603-7



STECKDOSE CAT5e KS RJ45 8/8

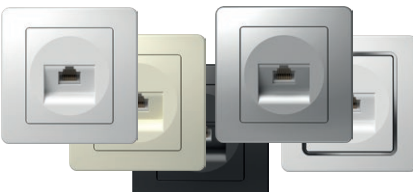

- KE37PW
- KE37IW
- KE37ES
- KE37CO
- KE37NB

- KS – keystone-Befestigungsstandard
- CAT5e, RJ45 8/8
- entspricht IEC 60603-7

SOCKET CAT5e KS RJ45 8/8

- KS keystone fixing standard
- CAT5e, RJ45 8/8
- in accordance with IEC 60603-7



STECKDOSE CAT6s KS RJ45 8/8 SLIM

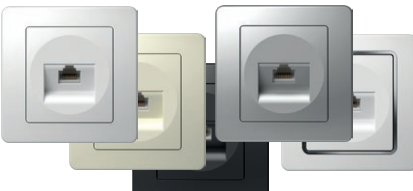

- KE40PW
- KE40IW
- KE40ES
- KE40CO
- KE40NB

- KS – keystone-Befestigungsstandard
- CAT6s, RJ45 8/8
- entspricht IEC 60603-7

SOCKET CAT6s KS RJ45 8/8 SLIM

- KS keystone fixing standard
- CAT6s, RJ45 8/8
- in accordance with IEC 60603-7



STECKDOSE TEL KS DOPPELT 2x RJ11 6/4

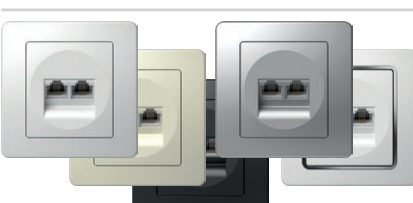

- KE38PW
- KE38IW
- KE38ES
- KE38CO
- KE38NB

- KS – keystone-Befestigungsstandard
- 2x RJ11 6/4
- entspricht IEC 60603-7

SOCKET TEL KS DOUBLE 2x RJ11 6/4

- KS keystone fixing standard
- 2x RJ11, 6/4
- in accordance with IEC 60603-7



STECKDOSE CAT5e KS DOPPELT 2x RJ45 8/8

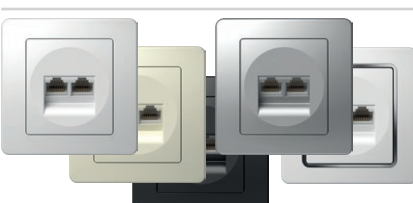

- KE39PW
- KE39IW
- KE39ES
- KE39CO
- KE39NB

- KS – keystone-Befestigungsstandard
- 2x CAT5e, RJ45 8/8
- entspricht IEC 60603-7

SOCKET CAT5e KS DOUBLE 2x RJ45 8/8

- KS keystone fixing standard
- 2x CAT5e, RJ45 8/8
- in accordance with IEC 60603-7



STECKDOSE CAT6s KS DOPPELT 2x RJ45 8/8 SLIM



- KE41PW
- KE41IW
- KE41ES
- KE41CO
- KE41NB

- KS – keystone-Befestigungsstandard
- 2x CAT6s, RJ45 8/8
- entspricht IEC 60603-7

SOCKET CAT6s KS DOUBLE 2x RJ45 8/8 SLIM

- KS keystone fixing standard
- 2x CAT6s, RJ45 8/8
- in accordance with IEC 60603-7



STECKDOSE TEL LT RJ11 6/4

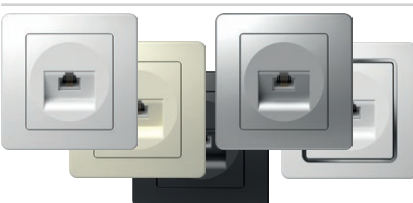

- KE35PW
- KE35IW
- KE35ES
- KE35CO
- KE35NB

- TEL LT mit Schraubklemmen
- Schraubklemmen
- RJ11 6/4
- entspricht IEC 60603-7

SOCKET TEL LT RJ11 6/4

- TEL LT screw
- screw contacts
- RJ11 6/4
- in accordance with IEC 60603-7

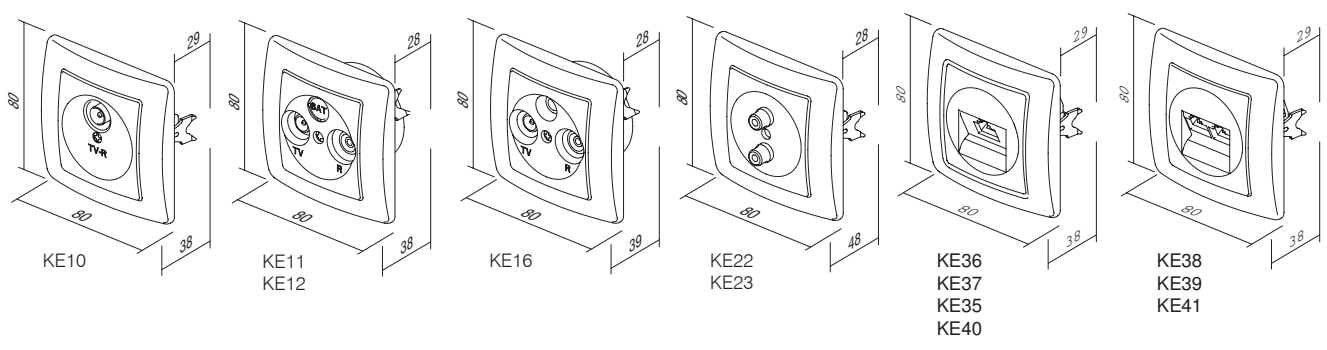
DECKEL KOMMUNIKATION KE

PE20

PW

Typ type	Bezeichnung description	Technische Daten technical data	Farbe colour
PE10	DECKEL TV-R COVER TV-R	2P/3P	<input type="checkbox"/> PW weiß-glänzend polar white
PE20	DECKEL KS EINFACH COVER KS SINGLE		<input type="checkbox"/> IW beige-glänzend ivory white
PE21	DECKEL KS DOPPELT COVER KS DOUBLE		<input type="checkbox"/> ES silber-matt elox silver
⋮	⋮	⋮	<input type="checkbox"/> CO weiß, Duroplast white thermoset
			<input type="checkbox"/> NB schwarz-glänzend night black

DECKEL TV-R 2P/3P

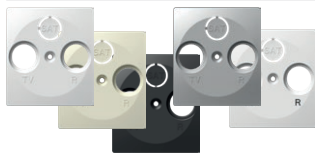

- PE10PW
- PE10IW
- PE10ES
- PE10CO
- PE10NB

- TV-R-Deckel, 2P oder 3P mit Schraube
COVER TV-R 2P/3P
- TV-R cover, 2P or 3P with screw



DECKEL KS EINFACH

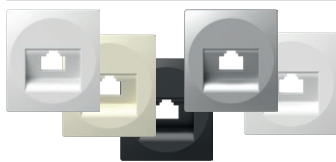

- PE20PW
- PE20IW
- PE20ES
- PE20CO
- PE20NB

- KS-Deckel einfach
COVER KS SINGLE
- KS cover single



DECKEL KS DOPPELT

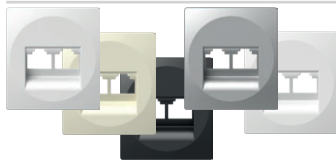

- PE21PW
- PE21IW
- PE21ES
- PE21NB

- KS-Deckel doppelt
COVER KS DOUBLE
- KS cover double



DECKEL TAE/TDO



- PE30PW
- PE30IW
- PE30ES
- PE30NB

- TAE- oder TDO-Deckel mit Schraube
COVER TAE/TDO
- TAE or TDO cover with screw

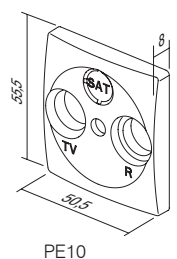
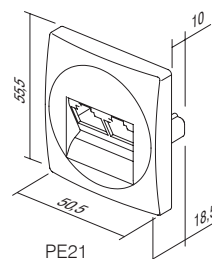
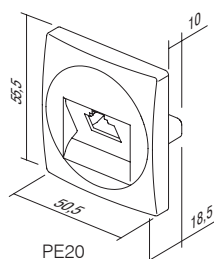
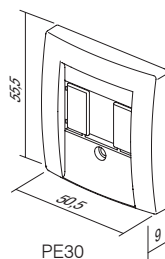



EE15

PW

Typ type	Bezeichnung description	Technische Daten technical data	Farbe colour
EE15	DIMMER DREH-WECHSEL DIMMER ROTATIVE 2WAY	RL 400W	<input type="checkbox"/> PW weiß-glänzend polar white
EE16	DIMMER DREH-WECHSEL DIMMER ROTATIVE 2WAY	RLC 400W	<input type="checkbox"/> IW beige-glänzend ivory white
EE19	DIMMER DREH-WECHSEL DIMMER ROTATIVE 2WAY	LED 100W	<input type="checkbox"/> ES silber-matt elox silver
⋮	⋮	⋮	<input type="checkbox"/> CO weiß, Duroplast white thermoset
⋮	⋮	⋮	<input type="checkbox"/> NB schwarz-glänzend night black

DIMMER DREH-WECHSEL RL 400W



EE15

- Dreh-Wechsel
- Belastung RL, 40–400 W
- kann mit Wechselschalter verbunden werden
- Verbindung von zwei Dimmern ist nicht gestattet
- entspricht EN 60669-1 und EN 60669-2-1
- Schraubklemmen 1,5 mm²
- Versorgung 230 V~ 50 Hz
- Durchmesser Knopf Ø6 mm
- inkl. Sicherung auswechselbar

DIMMER ROTATIVE 2WAY RL 400W

- rotation control with 2-way switch
- load RL, 40W - 400W
- 2-way switch combination is possible
- more dimmers combination is not allowed
- in accordance with EN 60669-1 and EN 60669-2-1
- plug-in contacts 1.5mm²
- supply 230V~ 50Hz
- button inner diameter Ø6mm
- replaceable fuse included

DIMMER DREH-WECHSEL RLC 400W



EE16

- Dreh-Wechsel
- Belastung RL, 20–400 W
- kann mit Wechselschalter verbunden werden
- Verbindung von zwei Dimmern ist nicht gestattet
- entspricht EN 60669-1 und EN 60669-2-1
- Schraubklemmen 1,5 mm²
- Versorgung 230 V~ 50 Hz
- Durchmesser Knopf Ø6 mm
- Elektroniksicherung

DIMMER ROTATIVE 2WAY RLC 400W

- rotation control with 2-way switch
- load RLC, 20W - 400W
- 2-way switch combination is possible
- more dimmers combination is not allowed
- in accordance with EN 60669-1 and EN 60669-2-1
- plug-in contacts 1.5mm²
- supply 230V~ 50Hz
- button inner diameter Ø6mm
- electronic fuse

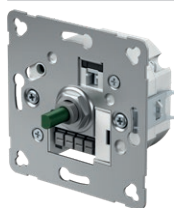

EE19

DIMMER DREH-WECHSEL LED 100W

- Dreh-Wechsel
- Belastung: LED, 0–100 W (max. 10 LED-Lampen)
GLS, 10–250 W
- kann mit Wechselschalter verbunden werden
- Verbindung von zwei Dimmern ist nicht gestattet
- entspricht EN 60669-1 und EN 60669-2-1
- Schraubklemmen 1,5 mm²
- Versorgung 230 V~ 50 Hz
- inkl. Sicherung auswechselbar
- Durchmesser Knopf Ø6 mm

DIMMER ROTATIVE 2WAY LED 100W

- rotation control with 2-way switch
- load: LED, 0-100W (max. 10 LEDs)
GLS, 10-250W
- 2-way switch combination is possible
- more dimmers combination is not allowed
- in accordance with EN 60669-1 and EN 60669-2-1
- plug-in contacts 1.5mm²
- supply 230V~ 50Hz
- replaceable fuse included
- button inner diameter Ø6mm

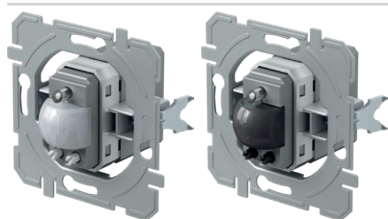

- EE32A1
- EE32A2

IR SCHALTER 5A 230V~

- IR-Schalter
- Versorgung: 230V~ ±10 % 50Hz
- Relais: 5A / 250V~ (Nulldurchgang)
- Schutzart: IP40
- Schraubklemmen: 0,75–2,5 mm²
- Erfassungswinkel: bis 110° bei 20°C
- Erfassungsbereich: ca. 8 m bei 20°C
- Einstellung der Beleuchtungszeit: von ca. 5 s bis 12 min
- Beleuchtungseinstellung: von ca. 5 bis 200 Lx
- Betriebstemperatur: von 0°C bis +40°C
- nicht geeignet für den Einbau in Dosen mit Tiefe 45 mm
- nur für Gebrauch im Innenbereich

IR SWITCH 5A 230V~

- IR infrared switch
- supply voltage: 230V~ ±10 % 50Hz
- relay: 5A / 250V~ (zero crossing)
- protection rating: IP40
- cross-section of wires at the contact terminal: 0.75 - 2.5 mm²
- detection angle: up to 110° at 20°C
- detection area: approx. 8 m at 20°C
- adjustability of duration: from approx. 5 s to 12 min
- adjustability of brightness: from approx. 5 to 200 LUX
- operating temperature: from 0°C to +40°C
- not suitable for installation in 45 mm deep boxes
- only for indoor usage



EE67

LADEGERÄT USB 5V 2,4A

- zum Laden der elektronischen Geräte über einen Standard-USB-Anschluss (kompatibel mit Apple-Geräten)
- Versorgung: 100 - 230 V~ 50 / 60 Hz
- Verbrauch während des Betriebs
300 mA bei 100 V~ / 150 mA bei 230 V~
- Verbrauch in Bereitstellung 30 mW bei 230 V~
- Ausgangsspannung 5 VDC (±5 %) SELV
- Schwankungen der Ausgangsspannung 150 mV
- nominaler Ausgangsstrom 2,4 A (±10 %)
- Konnektortyp: USB A / USB A
- Nutzleistung: max. 77 %
- Betriebstemperatur: 0°C / +45°C (im Innenbereich)
- Schutzart: IP20, nur für Gebrauch im Innenbereich geeignet
- Schutzklasse des Gerätes II
- Überspannungsschutz (EN 62109): Klasse III
- Schraubklemmen max. 2,5 mm²
- Gerät mit Kontaktversatz min. 3 mm
- entspricht EN 60950-1 und der EMC- und LVD-Richtlinie

USB POWER SUPPLY UNIT 5V 2.4A

- for charging electronic devices via a standard USB port (also compatible with Apple devices)
- power supply: 100-230V~ 50/60Hz
- power consumption: 300mA at 100V~/150mA at 230V~
- standby power consumption: 30mW at 230V~
- nominal output voltage: 5 VCD (± 5%) SELV
- output ripple voltage: 150mV
- nominal output current: 2.4A (±10%)
- connector type: USB A / USB A
- efficiency: maximum of 77%
- operating temperature: 0°C/+45°C (indoor use)
- IP protection class: IP20, indoor use only
- class device II
- overvoltage category (EN 62109): Class III
- screw contacts: max. 2.5 mm²
- device with a contact gap of at least 3mm
- in accordance with the EN 60950-1 and LVD & EMC directives

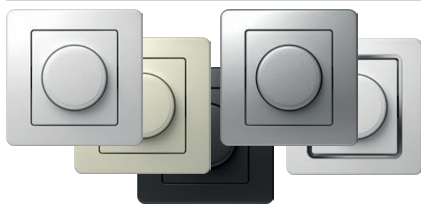

- EE15PW
- EE15IW
- EE15ES
- EE15CO
- EE15NB

DIMMER DREH-WECHSEL RL 400W

- Dreh-Wechsel
- Belastung RL, 40 W – 400 W
- kann mit Wechselschalter verbunden werden
- Verbindung von zwei Dimmern ist nicht gestattet
- entspricht EN 60669-1 und EN 60669-2-1
- Schraubklemmen 1,5 mm²
- Versorgung 230 V~ 50 Hz
- inkl. Sicherung auswechselbar



DIMMER ROTATIVE 2WAY RL 400W

- rotation control with 2-way switch
- load RL, 40W - 400W
- 2-way switch combination is possible
- more dimmers combination is not allowed
- in accordance with EN 60669-1 and EN 60669-2-1
- plug-in contacts 1.5mm²
- supply 230V~ 50Hz
- replaceable fuse included



- EE16PW
- EE16IW
- EE16ES
- EE16CO
- EE16NB

DIMMER DREH-WECHSEL RLC 400W

- Dreh-Wechsel
- Belastung RL, 20 W – 400 W
- kann mit Wechselschalter verbunden werden
- Verbindung von zwei Dimmern ist nicht gestattet
- entspricht EN 60669-1 und EN 60669-2-1
- Schraubklemmen 1,5 mm²
- Versorgung 230 V~ 50 Hz
- Elektroniksicherung



DIMMER ROTATIVE 2WAY RLC 400W

- rotation control with 2-way switch
- load RLC, 20W - 400W
- 2-way switch combination is possible
- more dimmers combination is not allowed
- in accordance with EN 60669-1 and EN 60669-2-1
- plug-in contacts 1.5mm²
- supply 230V~ 50Hz
- electronic fuse



- EE19PW
- EE19IW
- EE19ES
- EE19CO
- EE19NB

DIMMER DREH-WECHSEL LED 100W

- Dreh-Wechsel
- Belastung: LED, 0-100 W (max. 10 LED-Lampen)
GLS, 10-250 W
- kann mit Wechselschalter verbunden werden
- Verbindung von zwei Dimmern ist nicht gestattet
- entspricht EN 60669-1 und EN 60669-2-1
- Schraubklemmen 1,5 mm²
- Versorgung 230 V~ 50 Hz
- inkl. Sicherung auswechselbar



DIMMER ROTATIVE 2WAY LED 100W

- rotation control with 2-way switch
- load: LED, 0-100W (max. 10 LEDs)
GLS, 10-250W
- 2-way switch combination is possible
- more dimmers combination is not allowed
- in accordance with EN 60669-1 and EN 60669-2-1
- plug-in contacts 1.5mm²
- supply 230V~ 50Hz
- replaceable fuse included



- EE32PW
- EE32IW
- EE32ES
- EE32CO
- EE32NB

IR SCHALTER 5A 230V~

- IR-Schalter
- Versorgung: 230V~ ±10 % 50Hz
- Relais: 5A / 250V~ (Nulldurchgang)
- Schutzart: IP40
- Schraubklemmen: 0,75–2,5 mm²
- Erfassungswinkel: bis 110° bei 20°C
- Erfassungsbereich: ca. 8 m bei 20°C
- Einstellung der Beleuchtungszeit: von ca. 5 s bis 12 min
- Beleuchtungseinstellung: von ca. 5 bis 200 Lx
- Betriebstemperatur: von 0°C bis +40°C
- nicht geeignet für den Einbau in Dosen mit Tiefe 45 mm
- nur für Gebrauch im Innenbereich



IR SWITCH 5A 230V~

- IR infrared switch
- supply voltage: 230V~ ±10 % 50Hz
- relay: 5A / 250V~ (zero crossing)
- protection rating: IP40
- cross-section of wires at the contact terminal: 0.75 - 2.5 mm²
- detection angle: up to 110° at 20°C
- detection area: approx. 8 m at 20°C
- adjustability of duration: from approx. 5 s to 12 min
- adjustability of brightness: from approx. 5 to 200 LUX
- operating temperature: from 0°C to +40°C
- not suitable for installation in 45 mm deep boxes
- only for indoor usage



- EE67PW
- EE67IW
- EE67NB
- EE67ES

LADEGERÄT USB 5V 2,4A

- zum Laden der elektronischen Geräte über einen Standard-USB-Anschluss (kompatibel mit Apple-Geräten)
- Versorgung: 100 - 230 V~ 50 / 60 Hz
- Verbrauch während des Betriebs 300 mA bei 100 V~ / 150 mA bei 230 V~
- Verbrauch in Bereitstellung 30 mW bei 230 V~
- Ausgangsspannung 5 VDC ($\pm 5\%$) SELV
- Schwankungen der Ausgangsspannung 150 mV
- nominaler Ausgangsstrom 2,4 A ($\pm 10\%$)
- Konnektortyp: USB A / USB A
- Nutzleistung: max. 77%
- Betriebstemperatur: 0°C / +45°C (im Innenbereich)
- Schutzart: IP20, nur für Gebrauch im Innenbereich geeignet
- Schutzklasse des Gerätes II
- Überspannungsschutz (EN 62109): Klasse III
- Schraubklemmen max. 2,5 mm²
- Gerät mit Kontaktversatz min. 3 mm
- entspricht EN 60950-1 und der EMC- und LVD-Richtlinie



USB POWER SUPPLY UNIT 5V 2.4A

- for charging electronic devices via a standard USB port (also compatible with Apple devices)
- power supply: 100-230V~ 50/60Hz
- power consumption: 300mA at 100V~/150mA at 230V~
- standby power consumption: 30mW at 230V~
- nominal output voltage: 5 VCD ($\pm 5\%$) SELV
- output ripple voltage: 150mV
- nominal output current: 2.4A ($\pm 10\%$)
- connector type: USB A / USB A
- efficiency: maximum of 77%
- operating temperature: 0°C/+45°C (indoor use)
- IP protection class: IP20, indoor use only
- class device II
- overvoltage category (EN 62109): Class III
- screw contacts: max. 2.5 mm²
- device with a contact gap of at least 3mm
- in accordance with the EN 60950-1 and LVD & EMC directives

EE15, EE16, EE19

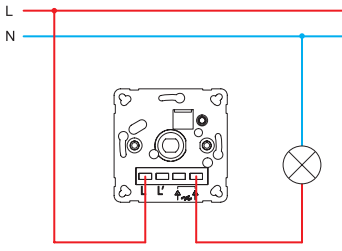

EE15, EE16, EE19

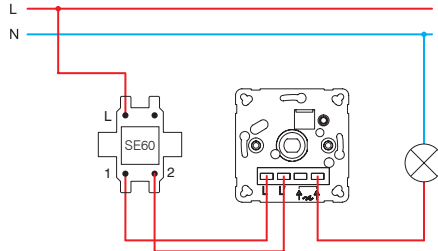

EE15, EE16, EE19

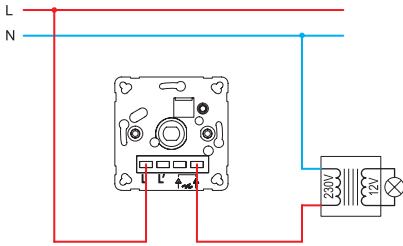

EE15, EE16, EE19

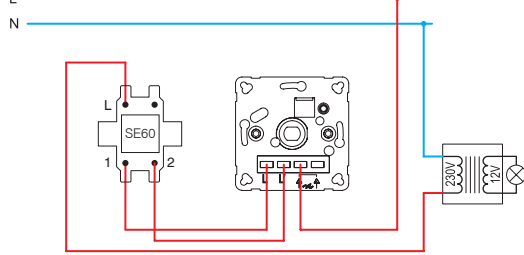

EE16, EE19

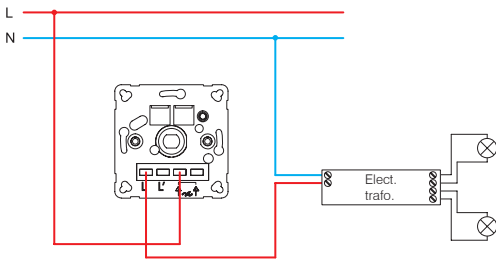

EE16, EE19

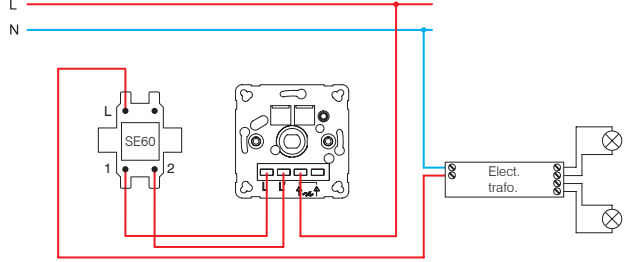

EE15 (40÷400W)

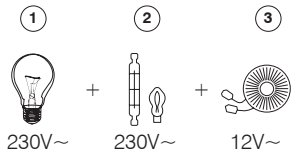

EE16 (20÷400W)

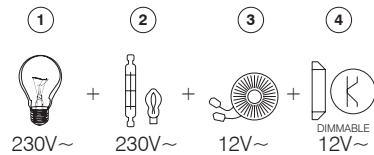

EE19 (GLS 10÷250W ; LED 0÷100W)

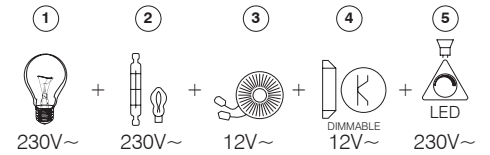

- 1 – Glühlampe / incandescent lamp
- 2 – Halogenlampe / halogen lamp

- 3 – klassischer Transformator / classical transformer
- 4 – dimmbarer elektronischer Transformator / dimmable electronic transformer
- 5 – dimmbare LED-Lampe / dimmable LED lamp

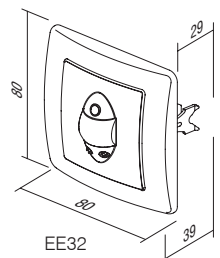
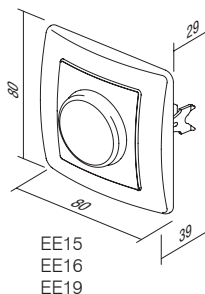
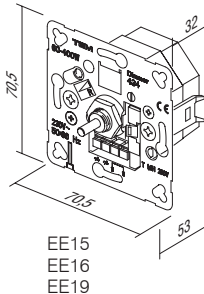
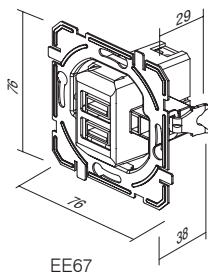



PE41

PW

Typ type	Bezeichnung description	Farbe colour
PE41	DECKEL FÜR DIMMER COVER DIMMER	<input type="checkbox"/> PW weiß-glänzend polar white <input type="checkbox"/> IW beige-glänzend ivory white <input type="checkbox"/> ES silber-matt elox silver <input type="checkbox"/> CO weiß, Duroplast white thermoset <input type="checkbox"/> NB schwarz-glänzend night black

DECKEL FÜR DIMMER Ø6



- PE41PW
- PE41IW
- PE41NB
- PE41ES
- PE41CO

- Deckel für Dimmer Ø6 mm
- für EE15, EE16, EE19

COVER DIMMER Ø6
- cover dimmer Ø6mm
- for EE15, EE16, EE19



DECKEL IR-BEWEGUNGSMELDER



- PE32PW
- PE32IW
- PE32NB
- PE32ES

- deckel IR-bewegungsmelder

COVER IR SWITCH
- cover IR switch



DECKEL LADEGERÄT USB



- PE67PW
- PE67IW
- PE67NB
- PE67ES

- Deckel für USB-Ladegerät

USB SUPPLY UNIT COVER
- USB supply unit cover

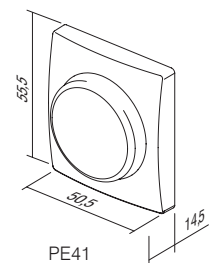
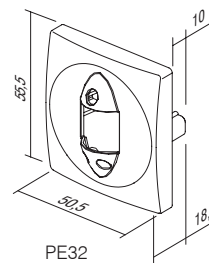
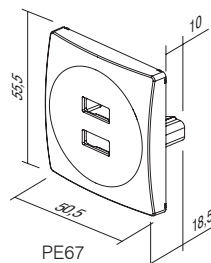

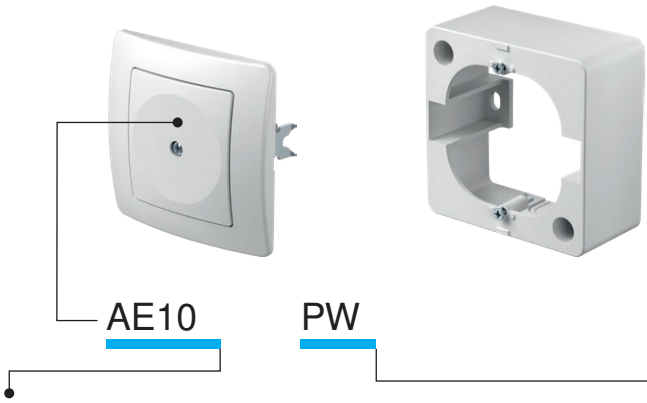

Typ type	Bezeichnung description	Farbe colour
AE10	BLLENDE BLANK	<input type="checkbox"/> PW weiß-glänzend polar white
AE20	HERDANSCHLUßDOSE 3P+N+E 5x4 mm ² CONNECTION BOX 3P+N+E 5X4mm ²	<input type="checkbox"/> IW beige-glänzend ivory white
AE30	AUFPUTZGEHÄUSE NO 1 SURFACE MOUNT BOX	<input type="checkbox"/> ES silber-matt elox silver
:	:	<input type="checkbox"/> CO weiß, Duroplast white thermoset
:	:	<input type="checkbox"/> NB schwarz-glänzend night black

BLLENDE



- AE10PW
- AE10IW
- AE10NB
- AE10ES
- AE10CO

- zum Abdecken von leeren Öffnungen

BLANK

- for filling up empty spaces



HERDANSCHLUßDOSE 3P+N+E 5x4 mm²



- AE20PW
- AE20IW

- 3P+N+E-Anschluss

- 16A 400V~

- entspricht VDE 0601-1:2000

- Schraubklemmen 1,5-4 mm²

CONNECTION BOX 5POLE 3P+N+E 5x4mm²

- 3P+N+E connection box

- 16A 400V~

- in accordance with VDE 0606-1:2000

- screw contacts 1.5-4mm²



AUFPUTZGEHÄUSE 1

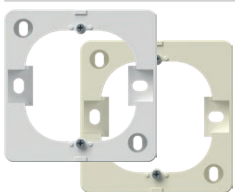

- AE30PW
- AE30IW

- Aufputzgehäuse

SURFACE MOUNT BOX 1

- surface mounting box



AUFPUTZGEHÄUSE DOPPELSTECKDOSE

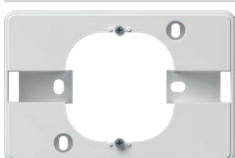

- AE31PW

- Aufputzgehäuse

SURFACE MOUNT BOX FOR EKONOMIK DOUBLE SOCKET

- surface mounting box



TAPETENSCHUTZ

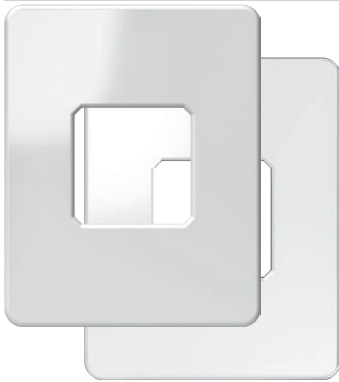

- AE50PW
- AE50TS

- Dekor-Tapetenschutz für Schalter oder Steckdosen

WALL PROTECTION

- protects surface around socket or switch

KINDERSCHUTZ KS



- AE51PW
- AE51IW

- KS-Kinderschutz gegen Berührung stromführender Teile

CHILD PROTECTION KS

- KS additional child protection insert - shuttered live contacts

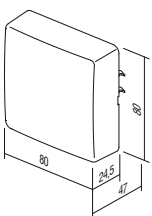

AE20

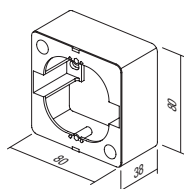

AE30

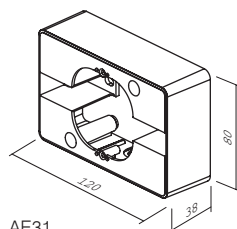

AE31

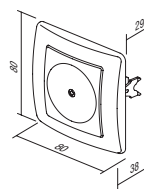

AE10

S U R R O U N D S O E

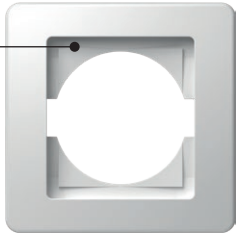

OE10

PW

Typ type	Bezeichnung description	Farbe colour
OE10	RAHMEN EKONOMIK 1 SURROUND EKONOMIK 1	<input type="checkbox"/> PW weiß-glänzend polar white
OE20	RAHMEN EKONOMIK 2 HORIZONTAL SURROUND EKONOMIK 2 HORIZONTAL	<input type="checkbox"/> IW beige-glänzend ivory white
OE30	RAHMEN EKONOMIK 3 HORIZONTAL SURROUND EKONOMIK 3 HORIZONTAL	<input type="checkbox"/> ES silber-matt elox silver
⋮	⋮	<input type="checkbox"/> CO weiß, Duroplast white thermoset
⋮	⋮	<input checked="" type="checkbox"/> NB schwarz-glänzend night black

RAHMEN EKONOMIK 1



- OE10PW
- OE10IW
- OE10ES
- OE10CO
- OE10NB

- dekorativer Rahmen 1-fach
- entspricht EN 60669-1
SURROUND EKONOMIK 1
- decorative surround 1-gang
- in accordance with EN 60669-1

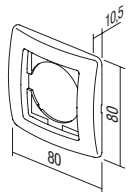

RAHMEN EKONOMIK 2 HORIZONTAL



- OE20PW
- OE20IW
- OE20ES
- OE20CO
- OE20NB

- dekorativer Rahmen 2-fach horizontal
- entspricht EN 60669-1
SURROUND EKONOMIK 2 HORIZONTAL
- decorative surround 2-gang horizontal
- in accordance with EN 60669-1

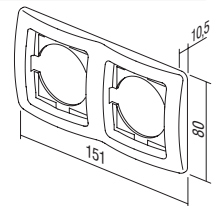

RAHMEN EKONOMIK 2 VERTIKAL



- OE21PW
- OE21IW
- OE21ES
- OE21CO
- OE21NB

- dekorativer Rahmen 2-fach vertikal
- entspricht EN 60669-1
SURROUND EKONOMIK 2 VERTIKAL
- decorative surround 2-gang vertical
- in accordance with EN 60669-1

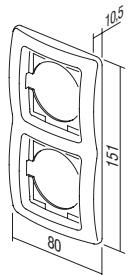

RAHMEN EKONOMIK 3 HORIZONTAL



- OE30PW
- OE30IW
- OE30ES
- OE30CO
- OE30NB

- dekorativer Rahmen 3-fach horizontal
- entspricht EN 60669-1
SURROUND EKONOMIK 3 HORIZONTAL
- decorative surround 3-gang horizontal
- in accordance with EN 60669-1

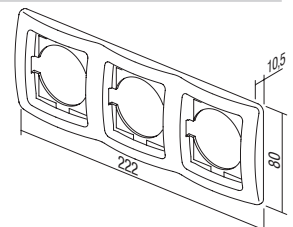



- OE31PW
- OE31IW
- OE31ES
- OE31CO
- OE31NB

RAHMEN EKONOMIK 3 VERTIKAL

- dekorativer Rahmen 3-fach vertikal
- entspricht EN 60669-1

SURROUND EKONOMIK 3 VERTICAL

- decorative surround 3-gang vertical
- in accordance with EN 60669-1

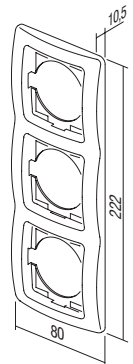

- OE40PW
- OE40IW
- OE40ES
- OE40NB

RAHMEN EKONOMIK 4 HORIZONTAL

- dekorativer Rahmen 4-fach horizontal
- entspricht EN 60669-1

SURROUND EKONOMIK 4 HORIZONTAL

- decorative surround 4-gang horizontal
- in accordance with EN 60669-1

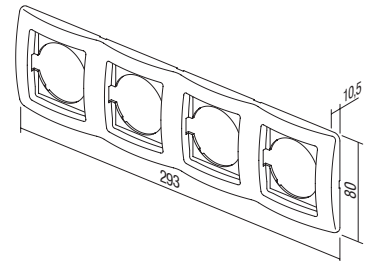

- OE41PW
- OE41IW
- OE41ES
- OE41NB

RAHMEN EKONOMIK 4 VERTIKAL

- dekorativer Rahmen 4-fach vertikal
- entspricht EN 60669-1

SURROUND EKONOMIK 4 VERTICAL

- decorative surround 4-gang vertical
- in accordance with EN 60669-1

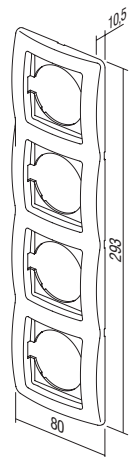

- OE50PW
- OE50IW
- OE50ES
- OE50NB

RAHMEN EKONOMIK 5 HORIZONTAL

- dekorativer Rahmen 5-fach horizontal
- entspricht EN 60669-1

SURROUND EKONOMIK 5 HORIZONTAL

- decorative surround 5-gang horizontal
- in accordance with EN 60669-1

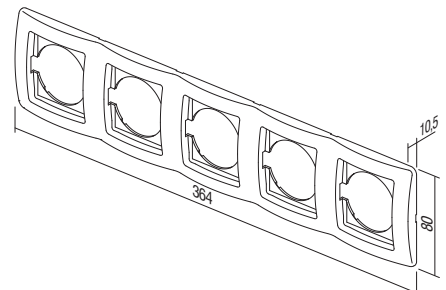

DEKORATIVE RAHMEN COLOR /
 COLOR DECORATIVE FRAMES



OE90GR	GRÜN / GREEN	OE90YL	GELB / YELLOW	OE90MB	MET. BLAU / MET. BLUE
OE90BL	BLAU / BLUE	OE90WH	WEISS / WHITE	OE90BZ	BRONZE / BRONZE
OE90VO	VIOLETT / VIOLET	OE90GY	GRAU / GREY	OE90CR	SILBER / SILVER
OE90PI	ROSA / PINK	OE90BK	SCHWARZ / BLACK	OE90GO	GOLD / GOLD
OE90RD	ROT / RED				





fontana



TEM





SF10

PW

TI

Typ type	Bezeichnung description	Technische Daten technical data	Farbe colour	Optionsbezeichnung 1 optional data 1
SF10	SCHALTER 1-POLIG SWITCH 1WAY	IP44 10AX 250V~	<input type="checkbox"/> PW weiß-matt white-mat	TI Glühlampe + Indikator neon lamp+indication
SF11	TASTER 1-POLIG PUSH BUTTON 1WAY	IP44 10A 250V~	<input type="checkbox"/> GY grau-matt grey-mat	
SF20	SCHALTER 2-POLIG SWITCH 2POLE	IP44 10AX 250V~		
:	:	:		
:	:	:		

SCHALTER 1-POLIG IP44 10AX 250V~



- SF10PW
- SF10GY

- 10AX 250V~, Typ SF10
- entspricht EN 60669-1
- Steckklemmen 1,5–2,5 mm²

SWITCH 1WAY IP44 10AX 250V~
- 10AX 250V~, type SF10
- in accordance with EN 60669-1
- plug-in contacts 1.5-2.5mm²



SCHALTER 1-POLIG IP44 10AX 250V~ __ TI



- SF10PWTI
- SF10GYTI

- TI Indikator + Glühlampe
- 10AX 250V~, Typ SF10
- entspricht EN 60669-1
- Steckklemmen 1,5–2,5 mm²

SWITCH 1WAY IP44 10AX 250V~ __ TI
- TI indicator+neon lamp
- 10AX 250V~, type SF10
- in accordance with EN 60669-1
- plug-in contacts 1.5-2.5mm²



TASTER 1-POLIG IP44 10A 250V~ __ TI



- SF11PWTI
- SF11GYTI

- TI Indikator + Glühlampe
- 10A 250V~, Typ SF11
- entspricht EN 60669-1
- Steckklemmen 1,5–2,5 mm²

PUSH BUTTON 1WAY IP44 10A 250V~ __ TI
- TI indicator+neon lamp
- 10A 250V~, type SF11
- in accordance with EN 60669-1
- plug-in contacts 1.5-2.5mm²



SCHALTER 2-POLIG IP44 10AX 250V~



- SF20PW
- SF20GY

- 10AX 250V~, Typ SF20
- entspricht EN 60669-1
- Steckklemmen 1,5–2,5 mm²

SWITCH 2POLE IP44 10AX 250V~
- 10AX 250V~, type SF20
- in accordance with EN 60669-1
- plug-in contacts 1.5-2.5mm²



SCHALTER SERIEN IP44 10AX 250V~



- SF50PW
- SF50GY

- 10AX 250V~, Typ SF50
- entspricht EN 60669-1
- Steckklemmen 1,5–2,5 mm²

SWITCH 2GANG-1WAY IP44 10AX 250V~
 - 10AX 250V~, type SF50
 - in accordance with EN 60669-1
 - plug-in contacts 1.5-2.5mm²



TASTER SERIEN IP44 10A 250V~



- SF51PW
- SF51GY

- 10A 250V~, Typ SF51
- entspricht EN 60669-1
- Steckklemmen 1,5–2,5 mm²

PUSH BUTTON 2GANG-1WAY IP44 10A 250V~
 - 10A 250V~, type SF51
 - in accordance with EN 60669-1
 - plug-in contacts 1.5-2.5mm²



SCHALTER WECHSEL IP44 10AX 250V~



- SF60PW
- SF60GY

- 10AX 250V~, Typ SF60
- entspricht EN 60669-1
- Steckklemmen 1,5–2,5 mm²

SWITCH 2WAY IP44 10AX 250V~
 - 10AX 250V~, type SF60
 - in accordance with EN 60669-1
 - plug-in contacts 1.5-2.5mm²



SCHALTER WECHSEL IP44 10AX 250V~ __ TI



- SF60PWTI
- SF60GYTI

- TI Indikator + Glühlampe
- 10AX 250V~, Typ SF60
- entspricht EN 60669-1
- Steckklemmen 1,5–2,5 mm²

SWITCH 2WAY IP44 10AX 250V~ __ TI
 - TI indicator+neon lamp
 - 10AX 250V~, type SF60
 - in accordance with EN 60669-1
 - plug-in contacts 1.5-2.5mm²



SCHALTER DOPPELT AUS/WECHSEL 10AX 250V~



- SF63PW
- SF63GY

- 10AX 250V~, Typ SF63
- entspricht EN 60669-1
- Steckklemmen 1,5–2,5 mm²

SWITCH 2WAY DOUBLE IP44 10AX 250V~
 - 10AX 250V~, type SF63
 - in accordance with EN 60669-1
 - plug-in contacts 1.5-2.5mm²



SCHALTER KREUZ IP44 10AX 250V~



- SF70PW
- SF70GY

- 10AX 250V~, Typ SF70
- entspricht EN 60669-1
- Steckklemmen 1,5–2,5 mm²

SWITCH INTERMEDIATE IP44 10AX 250V~
 - 10AX 250V~, type SF70
 - in accordance with EN 60669-1
 - plug-in contacts 1.5-2.5mm²

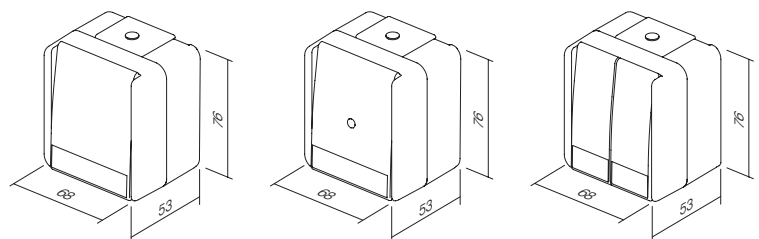

S T E C K D O S E N V F
S O C K E T S



VF10

PW

Typ type	Bezeichnung description	Technische Daten technical data	Farbe colour
VF10	STECKDOSE SCHUKO+KLAPPDECKEL SOCKET SCHUKO+COVER	IP44 2P+E 16A 250V~	<input type="checkbox"/> PW weiß-matt white-mat <input type="checkbox"/> GY grau-matt grey-mat

STECKDOSE SCHUKO+KLAPPDECKEL IP44 2P+E 16A 250V~



- VF10PW
- VF10GY

- Schraubklemmen 1,5–2,5 mm²
- Steckdose mit Schutzkontakt mit Klappdeckel
- 16A 250V~, Typ VF10
- entspricht EN 60884-1, CEE7

SOCKET SCHUKO+COVER IP44 2P+E 16A 250V~

- screw contacts 1.5-2.5mm²
- 2P+E schuko+cover
- 16A 250V~, type VF10
- in accordance with EN 60884-1, CEE7



STECKDOSE SCHUKO+DECKEL IP44 2P+E 16A 250V~ BV



- VF12PW
- VF12GY

- BV – Steckklemmen 1,5–2,5 mm²
- Steckdose mit Schutzkontakt mit Klappdeckel
- 16A 250V~, Typ VF12
- entspricht EN 60884-1, CEE7

SOCKET SCHUKO+COVER IP44 2P+E 16A 250V~ BV

- BV plug-in contacts 1.5-2.5mm²
- 2P+E schuko+cover
- 16A 250V~, type VF12
- in accordance with EN 60884-1, CEE7

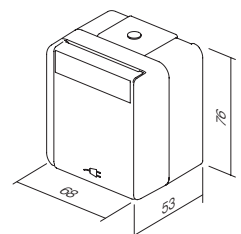

SF10
SF60

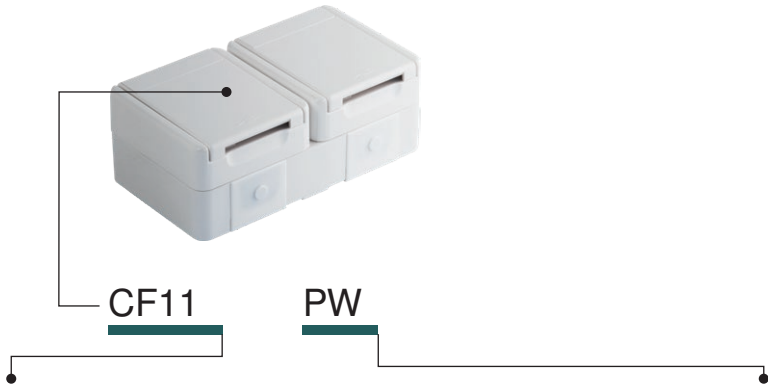

Typ type	Bezeichnung description	Technische Daten technical data	Farbe colour
CF10	SET STECKDOSE SCHUKO DOPPELT HORIZONTAL SOCKET SET SCHUKO DOUBLE HORIZ	2x 2P+E 16A 250V~ IP44	<input type="checkbox"/> PW weiß-matt white-mat
CF11	SET STECKDOSE SCHUKO DOPPELT VERTIKAL SOCKET SET SCHUKO DOUBLE VERT	2x 2P+E 16A 250V~ IP44	<input checked="" type="checkbox"/> GY grau-matt grey-mat
CF12	SET STECKDOSE SCHUKO+SCHALTER WECHSEL HORIZONTAL SOCKET SCH+SWITCH 2WAY HORIZ	16A + 10A 250V~ IP44	
⋮	⋮	⋮	
⋮	⋮	⋮	



- CF10PW
- CF10GY

SET STECKDOSE SCHUKO DOPPELT HORIZONTAL IP44 2x 2P+E 16A 250V~

- Schraubklemmen 1,5–2,5 mm²
- 2x Steckdose mit Schutzkontakt mit Klappdeckel horizontal
- 16A 250V~, Typ CF10
- entspricht EN 60884-1, CEE7

SOCKET SET SCHUKO DOUBLE HORIZONTAL IP44 2x 2P+E 16A 250V~

- screw contacts 1.5-2.5mm²
- 2x 2P+E schuko+cover horizontal
- 16A 250V~, type CF10
- in accordance with EN 60884-1, CEE7





- CF11PW
- CF11GY

SET STECKDOSE SCHUKO DOPPELT VERTIKAL IP44 2x 2P+E 16A 250V~

- Schraubklemmen 1,5–2,5 mm²
- 2x Steckdose mit Schutzkontakt mit Klappdeckel vertikal
- 16A 250V~, Typ CF11
- entspricht EN 60884-1, CEE7

SOCKET SET SCHUKO DOUBLE VERTICAL IP44 2x 2P+E 16A 250V~

- screw contacts 1.5-2.5mm²
- 2x 2P+E schuko+cover vertical
- 16A 250V~, type CF11
- in accordance with EN 60884-1, CEE7





- CF12PW
- CF12GY

SET STECKDOSE SCHUKO+SCHALTER WECHSEL HORIZONTAL IP44 16A + 10AX 250V~

- Schraubklemmen (Steckdose), Steckklemmen (Schalter) 1,5–2,5 mm²
- Steckdose mit Schutzkontakt mit Klappdeckel + Wechselschalter horizontal
- 16A + 10AX 250V~, Typ CF12
- entspricht EN 60884-1, CEE7, EN 60669-1

SOCKET SCH+SWITCH SET 2WAY HORIZONTAL IP44 16A + 10AX 250V~

- screw (socket), plug-in (switch) contacts 1.5-2.5mm²
- 2P+E schuko+cover + switch 2-way horizontal
- 16A + 10AX 250V~, type CF12
- in accordance with EN 60884-1, CEE7, EN 60669-1



**SET STECKDOSE SCHUKO+SCHALTER WECHSEL VERTIKAL IP44
16A + 10AX 250V~**



- CF13PW
- CF13GY

- Schraubklemmen (Steckdose), Steckklemmen (Schalter) 1,5–2,5 mm²
- Steckdose mit Schutzkontakt mit Klappdeckel + Wechselschalter vertikal
- 16A + 10AX 250V~, Typ CF13
- entspricht EN 60884-1, CEE7, EN 60669-1

**SOCKET SCH+SWITCH 2WAY SET
VERTICAL IP44 16A + 10AX 250V~**

- screw (socket), plug-in (switch) contacts 1.5-2.5mm²
- 2P+E schuko+cover + switch 2-way vertical
- 16A + 10AX 250V~, type CF13
- in accordance with EN 60884-1, CEE7, EN 60669-1



SET STECKDOSE SCHUKO DOPPELT HORIZONTAL IP44 2x 2P+E 16A 250V~BV



- CF14PW
- CF14GY

- BV – Steckklemmen 1,5–2,5 mm²
- 2x Steckdose mit Schutzkontakt mit Klappdeckel horizontal
- 16A 250V~, Typ CF14
- entspricht EN 60884-1, CEE7

**SOCKET SET SCHUKO DOUBLE
HORIZONTAL IP44 2x 2P+E 16A 250V~ BV**

- BV plug-in contacts 1.5-2.5mm²
- 2x 2P+E schuko+cover horizontal
- 16A 250V~, type CF14
- in accordance with EN 60884-1, CEE7



SET STECKDOSE SCHUKO DOPPELT VERTIKAL IP44 2x 2P+E 16A 250V~ BV



- CF15PW
- CF15GY

- BV – Steckklemmen 1,5–2,5 mm²
- 2x Steckdose mit Schutzkontakt mit Klappdeckel vertikal
- 16A 250V~, Typ CF15
- entspricht EN 60884-1, CEE7

**SOCKET SET SCHUKO DOUBLE VERTICAL
IP44 2x 2P+E 16A 250V~ BV**

- BV plug-in contacts 1.5-2.5mm²
- 2x 2P+E schuko+cover vertical
- 16A 250V~, type CF15
- in accordance with EN 60884-1, CEE7



**SET STECKDOSE SCHUKO+SCHALTER WECHSEL HORIZONTAL IP44
16A + 10AX 250V~ BV**



- CF16PW
- CF16GY

- BV – Steckklemmen 1,5–2,5 mm²
- Steckdose mit Schutzkontakt mit Klappdeckel + Wechselschalter horizontal
- 16A + 10AX 250V~, Typ CF16
- entspricht EN 60884-1, CEE7, EN 60669-1

**SOCKET+SWITCH SET SCH+2WAY
HORIZONTAL IP44 16A + 10AX 250V~ BV**

- BV plug-in contacts 1.5-2.5mm²
- 2P+E schuko+cover + switch 2-way horizontal
- 16A + 10AX 250V~, type CF16
- in accordance with EN 60884-1, CEE7, EN 60669-1



**SET STECKDOSE SCHUKO+SCHALTER WECHSEL VERTIKAL IP44
16A + 10AX 250V~ BV**



- CF17PW
- CF17GY

- BV – Steckklemmen 1,5–2,5 mm²
- Steckdose mit Schutzkontakt mit Klappdeckel + Wechselschalter vertikal
- 16A + 10AX 250V~, Typ CF17
- entspricht EN 60884-1, CEE7, EN 60669-1

**SOCKET SCH+SWITCH 2WAY SET
VERTICAL IP44 16A + 10AX 250V~ BV**

- BV plug-in contacts 1.5-2.5mm²
- 2P+E schuko+cover + switch 2-way vertical
- 16A + 10AX 250V~, type CF17
- in accordance with EN 60884-1, CEE7, EN 60669-1



Z U B E H Ö R A F
A C C E S S O R I E S

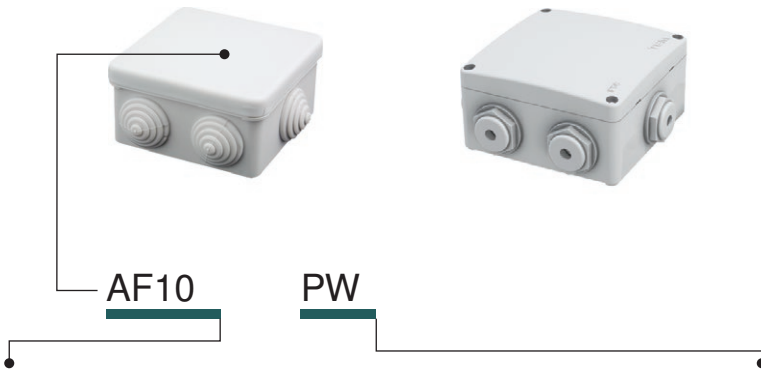

Typ type	Bezeichnung description	Technische Daten technical data	Farbe colour
AF10	ABZWEIGKASTEN DISTRIBUTION BOX	IP44 RN01	<input type="checkbox"/> PW weiß-matt white-mat
AF20	ABZWEIGKASTEN DISTRIBUTION BOX	IP55 NDO1	<input type="checkbox"/> GY grau-matt grey-mat

ABZWEIGKASTEN IP44 RN01



- AF10PW
- AF10GY

- Aufputzabzweigkasten IP44
- 16A 400V~
- entspricht IEC/EN 60670-1, IEC/EN 60670-22
DISTRIBUTION BOX IP44 RN01
- surface mounting distribution box IP44
- 16A 400V~
- in accordance with IEC/EN 60670-1, IEC/EN 60670-22

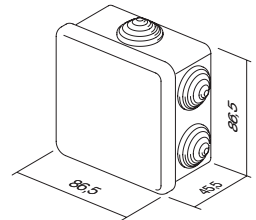

ABZWEIGKASTEN IP55 NDO1



- AF20PW
- AF20GY

- Aufputzabzweigkasten IP55
- inkl. Einführungen
- entspricht IEC/EN 60670-1, IEC/EN 60670-22
DISTRIBUTION BOX IP55 NDO1
- surface mounting connection box IP55
- glands included
- in accordance with IEC/EN 60670-1, IEC/EN 60670-22

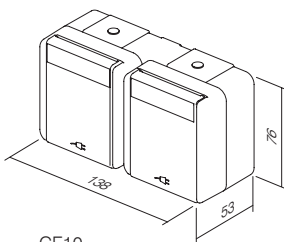
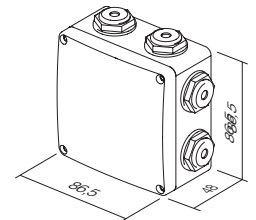

CF10
CF14

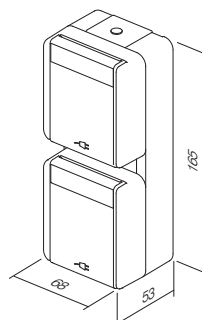

CF11
CF15

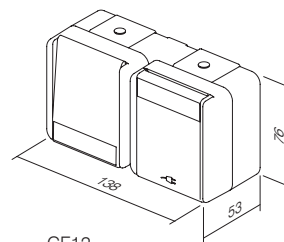

CF12
CF16

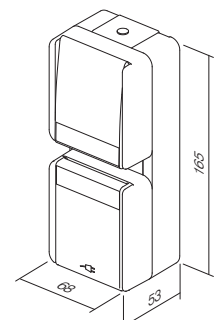

CF13
CF17

Typ	Bezeichnung	Seite	Typ	Bezeichnung	Seite
SCHALTER SM			KOMMUNIKATION KM		
SM10	SCHALTER 1-POLIG 16AX 250V- 1M	38	KM10--	TV-EINZELDOSE 0dB 1M	52
SM11	TASTER 1-POLIG 16A 250V- 1M	38	KM20--	TV-EINZELDOSE 0dB 2M	52
SM12	SCHALTER 1-POLIG 20A 250V- 1M	38	KM11--	TV-ENDDOSE 1dB 1M	52
SM20	SCHALTER 2-POLIG 16AX 250V- 1M	38	KM12--	TV-DURCHGANGSDOSE 10dB 1M	52
SM40	SCHALTER JALOUSIE 1-0-2 16AX 250V- 1M	39	KM15--	SAT-EINZELDOSE 0dB 1M	53
SM41	TASTER JALOUSIE 1-0-2 16A 250V- 1M	39	KM24--	SAT-EINZELDOSE 0dB 2M	53
SM60	SCHALTER WECHSEL 16AX 250V- 1M	39	KM16--	SAT-ENDDOSE 1dB 1M	53
SM61	TASTER WECHSEL 16A 250V- 1M	39	KM19--	R-EINZELDOSE 0dB 1M	53
SM70	SCHALTER KREUZ 16AX 250V- 1M	39	KM29--	R-EINZELDOSE 0dB 2M	53
SM10	SCHALTER 1-POLIG 16AX 250V- 1M	40	KM25--	SAT-TV-ENDDOSE 1dB 2M	53
SM10--IN	SCHALTER 1-POLIG 16AX 250V- 1M IN	40	KM22--	STECKDOSE AUDIO 2xRCA 1M	54
SM11--	TASTER 1-POLIG 16A 250V- 1M	40	KM23--	STECKDOSE AUDIO-LAUTSPRECHER 1M	54
SM11--IN01	TASTER 1-POLIG 16A 250V- 1M IN 01	40	KM26--	STECKDOSE AUDIO-LAUTSPRECHER 2M	54
SM11--IN02	TASTER 1-POLIG 16A 250V- 1M IN 02	41	KM30--	STECKDOSE TEL LT RJ11 6/4 1M	55
SM20--NT03	SCHALTER 2-POLIG 16AX 250V- 1M NT 03	41	KM31--	STECKDOSE TEL BT SEC 6/6 1M	55
SM20--IN	SCHALTER 2-POLIG 16AX 250V- 1M IN	41	KM36--	STECKDOSE TEL KS RJ11 6/4 1M	55
SM40--NT10	SCHALTER JALOUSIE 1-0-2 16AX 250V- 1M NT 10	41	KM37--	STECKDOSE CAT5e KS RJ45 8/8 1M	55
SM41--NT10	TASTER JALOUSIE 1-0-2 16A 250V- 1M NT 10	41	KM35--	ADAPTER KS 1M	55
SM60--	SCHALTER WECHSEL 16AX 250V- 1M	41	KM38--	ADAPTER KS MIT STAUBSCHUTZ 1M	55
SM61--	TASTER WECHSEL 16A 250V- 1M	42	KM39--	STECKDOSE CAT6 RJ45 SCH KS 8/8 1M	56
SM62--CD	TASTER WECHSEL MIT SCHNUR 16A 250V- 1M CD	42	KM50--	ADAPTER KS UNIVERSAL 1M	56
SM70--	SCHALTER KREUZ 16AX 250V- 1M	42	KM40--	ADAPTER PD 1M	56
WIPPE TM			KM43--	ADAPTER PD MIT STAUBSCHUTZ 1M	56
TM11--	WIPPE 1M	43	KM46--	ADAPTER R&M 1M	56
TM11--IN	WIPPE 1M IN	43	KM52--	ADAPTER R&M CAT6A 1M	56
TM12--	WIPPE 2M	43	KM47--	ADAPTER R&M MIT STAUBSCHUTZ 1M	57
TM12--IN	WIPPE 2M IN	43	KM53--	ADAPTER R&M CAT6A MIT STAUBSCHUTZ 1M	57
TM13--IL	WIPPE 2M MIT NAMENSSCHILD	44	KM45	ADAPTER LK 1M	58
TM15--	WIPPE 1M 2-POLIG	44	KA26	ADAPTER NEXSANS/SCHRACK 2M	58
TM21--	BLENDE 1M	44	KM48--	ADAPTER AT&T SYSTIMAX MIT STAUBSCHUTZ 1M	58
TM22--	BLENDE 2M	44	KM51--	STECKDOSE USB TYP A 1M	58
TM31--	KABELEINFÜHRUNG 1M	44	KOMMUNIKATIONSZUBEHÖR KA		
BELEUCHTUNG IA			KA10	KONNEKTOR KS CAT3 RJ11 6/4	59
IA10--	GLÜHLAMPE 230V- 0,34W	46	KA11	KONNEKTOR KS CAT5e RJ45 8/8	59
IA20--	LED-LAMPE 230V AC/DC 0,4W	6	KA12	KONNEKTOR KS CAT5eS RJ45 8/8	59
IA21--	LED-LAMPE 24V AC/DC 0,2W	46	KA15	KONNEKTOR KS CAT6 SCHRACK RJ45 8/8	59
IA22--	LED-LAMPE 12V AC/DC 0,1W	46	KA16	KONNEKTOR KS CAT6S SCHRACK RJ45 8/8	59
IA50	RC-SCHALTUNG 250V-	6	KA17	KONNEKTOR KS CAT6a SCHRACK RJ45 8/8	59
STECKDOSEN VM			KA18	KONNEKTOR SLIM KS CAT6S SCHRACK RJ45 8/8	60
VM10--	STECKDOSE SCHUKO+KS 2P+E 16A 250V- 2M	48	KA27	KONNEKTOR KS HDMI	60
VM11--	STECKDOSE SCHUKO+KS+KLAPPDECKEL 2P+E 16A 250V- 2M	48	KA28	KABEL KS HDMI	60
VM20--	STECKDOSE EURO+KS 2P 10A 250V- 1M	49	ELEKTRONIK EM		
VM40--	STECKDOSE FRANZÖSISCH+KS 2P+E 16A 250V- 2M	49	EM12--	DIMMER DREH-WECHSEL RL 300W 1M	61
VM41--	STECKDOSE FRANZÖSISCH+KS+KLAPPDECKEL 2P+E 16A 250V- 2M	49	EM13--	DIMMER DREH-WECHSEL LED 60W 1M	61
VM30--	STECKDOSE ITALIENISCH P17/11+KS 2P+E 16A 250V- 1M	49	EM14--	DIMMER DREH-WECHSEL LED 180W	62
VM31--	STECKDOSE SCHUKO/ITALIENISCH P17/11+KS 2P+E 16A 250V- 2M	49	EM15--	DIMMER DREH-AUS R 250W 1M	62
VM32--	STECKDOSE SCHUKO/ITALIENISCH P30+KS 2P+E 16A 250V- 2M	50	EM16--	1-10 V DIMMER DREH-WECHSEL	62
VM33--	STECKDOSE ITALIENISCH P11+KS 2P+E 10A 250V- 1M	50	EM23	EINBAUDIMMER R (250 W), (RC,RL 200VA)	63
VM21--	STECKDOSE EURO/AMERIKANISCH+KS 2P 16A 250V- 1M	50	EM18	DIMMER EINBAU LED 250W	63
VM52--	STECKDOSE BRITISCH BS 1363+KS 2P+E 13A 250V- 2M	50	EM19	DIMMER EINBAU DC LED 96W	63
VM55--	STECKDOSE MULTISTANDARD+KS 2P+E 13A 250V- 2M	50	EM25--	SCHALTER/DIMMER UNIVERSAL RLC 0-300W 2M	65
VM80	ÜBERSpannungSSchutz MPE MINI 275V/50Hz	50	EM26--	KONTROLLTASTER 2M	67
			EM27	STÖRUNGSFLITER	67
			EM25PPOL20	SET SCHALTER/DIMMER UNIVERSAL RLC 0-300W 2M PP OL20	67
			EM31--	IR-SCHALTER 5A 230V- 1M	68
			EM32--	IR-SCHALTER 5A 230V- 2M	68
			EM37--	ELEKTRONISCHES THERMOSTAT 6A 230V- 2M	70
			EM38--	HEIZUNGSTHERMOSTAT 5(2)A 230V- 2M	71
			EM39--	HEIZUNGS-/KÜHLUNGSTHERMOSTAT 3(1,5)A 230V- 2M	71
			NM39	MONTAGETRÄGER MIT SCHRAUBEN FÜR THERMOSTATE FANTINI COSMI 3M	72
			EM40--	ENERGIESPAR-KARTENSCHALTER 3A 250V- 3M	72
			EM47	KARTE ISO	72
			EM44--	ENERGIESPAR-KARTENSCHALTER RF HF 13,56MHz 3M	73
			EM49	RELAISEINHEIT FÜR KARTENSCHALTER 2x16A 250V-	73
			EM45	KABELEINFÜHRUNG SPL-1	73
			EM60--	RASIERSTECKDOSE 230V-/120V- 3M	74
			EM67--	LADEGERÄT USB 5V 2,4A 1M	74
			EM68--	LADEGERÄT USB 5V 3,0A	75
			EM55	LED-NOTLEUCHE 250V- 0,9W, NiCd 3h 7M	75
			EM57	LED-NOTLEUCHE 230V-50Hz, 0,5W, NiMH 2h 2M	75
			EM50--	LED-LAMPE EINFARBIG 250V- 0,8W 2M	76
			EM51--	LED-LAMPE ZWEIFARBIG 250V- 2x0,4W 2M	76
			EM52--	LED-LAMPE 3D ZWEIFARBIG 250V- 2x0,4W 2M	76
			EM71--	FINGERABDRUCKLESER BIOPASS 2M	77
			EM80	SCHALTER BERÜHRUNGSLOS 10A 240V-	78
			EM81	KONTROLLSCHALTER BERÜHRUNGSLOS	78
			EM91--	SUMMER 8VA 12V- 1M	79
			EM93--	KLINGEL 8VA 12V- 1M	79
			EM94--	KLINGEL 230V- 6mA rms 1M	79
			EM95--	LAUTSTÄRKENREGLER FÜR 100 V AUDIOLINIE 35W 2M	80
			EM96--	NIEDEROHMIGER LAUTSTÄRKENREGLER 4-8 Ω 35W 2M	80

Typ	Bezeichnung	Seite	Typ	Bezeichnung	Seite
SETS CM			D O S E N		
CM10--	SET STECKDOSEN 2x SCHUKO 2P+E 16A 250V~ 4M	81	RUNDDOSEN		
CM11--	SET STECKDOSEN 3x SCHUKO 2P+E 16A 250V~ 7M	81	DE10	RUNDDOSE ZIEGELWAND SM60-01	110
CM15	SET VERDRAHTUNGSBRÜCKEN FARBIG 3x1,5mm ² 1M	82	DE11	RUNDDOSE ZIEGELWAND TIEF SM60-06	110
CM16	SET VERDRAHTUNGSBRÜCKEN FARBIG 3x2,5mm ² 2M	82	DE30	ABSTANDSTUTZEN SM60-03	110
CM17	SCHRAUBEN-SET 3,5x20	82	DE31	ABSTANDSTUTZEN SM60-04	110
CM18	SCHRAUBEN-SET 3,5x35	82	DE12	RUNDDOSE ZIEGELWAND MD65-46	111
CM19	SCHRAUBEN-SET 3,5x50	82	DE13	RUNDDOSE ZIEGELWAND TIEF MD65-60	111
CM22--	SCHALTER-SET IP44 2M	82	DE14	VERLÄNGERUNG FÜR RUNDDOSE ZIEGELWAND MD65-46	111
CM23--	STECKDOSE-SET IP44 2M	82	DE32	ABSTANDSTUTZEN MD65-71	111
CM25--OL	BADEZIMMER-SET 3x20A 250V- 4M OL	82	DE33	ABSTANDSTUTZEN MD65-91	111
CM25--OS	BADEZIMMER-SET 3x20A 250V- 4M OS	82	DE20	FEDERDECKEL 60	111
NM41	MONTAGETRÄGER FÜR BADEZIMMER-SET 4M	83	DE21	FEDERDECKEL 65	111
OL41--	RAHMEN LINE FÜR BADEZIMMER-SET	83	DE22	ABDECKUNG DEKORATIV SM60	111
OS41--	RAHMEN SOFT FÜR BADEZIMMER-SET	83	HE10	RUNDDOSE HOHLWAND SM68x40	114
ANTIBAKTERIENPROGRAMM AW			HE11	RUNDDOSE HOHLWAND SM68x55	114
TM11AW--	WIPPE 1M	85	BE10	RUNDDOSE BETONWAND 60-49	114
TM11AWIN	WIPPE 1M IN	85	BE11	RUNDDOSE BETONWAND TIEF 60-77	114
TM12AW--	WIPPE 2M	85	BE20	GEGENLAGER FÜR RUNDDOSE BETONWAND	114
TM12AWIN	WIPPE 2M IN	85	BE21	ROHREINFÜHRUNG 16 FÜR RUNDDOSE BETONWAND	114
TM21AW--	BLLENDE 1M	85	RECHTECKDOSEN		
TM22AW--	BLLENDE 2M	85	DM30	RECHTECKDOSE ZIEGELWAND PM3	118
VM10AW--	STECKDOSE SCHUKO+KS 2P+E 16A 250V- 2M	86	DM31	RECHTECKDOSE ZIEGELWAND PM3-65	118
VM11AW--	STECKDOSE SCHUKO+KS+KLAPPDECKEL 2P+E 16A 250V- 2M	86	DM40	RECHTECKDOSE ZIEGELWAND PM4	118
VM20AW--	STECKDOSE EURO+KS 2P 10A 250V- 1M	86	DM41	RECHTECKDOSE ZIEGELWAND PM4-65	118
KM11AW--	TV-ENDDOSE 1dB 1M	86	DM70	RECHTECKDOSE ZIEGELWAND PM7	119
KM35AW--	ADAPTER KS 1M	86	DM71	RECHTECKDOSE ZIEGELWAND PM7-65	119
OS20AW--	RAHMEN SOFT 2M	87	DM72	RECHTECKDOSE ZIEGELWAND PM72-65	119
OS24AW--	RAHMEN SOFT 2x2M	87	DM80	ABSTANDHALTER FÜR RECHTECKDOSE PM	119
OS26AW--	RAHMEN SOFT 3x2M	87	DM33	FEDERDECKEL PM3	120
OS30AW--	RAHMEN SOFT 3M	87	DM34	ABDECKUNG DEKORATIV PM3	120
OS40AW--	RAHMEN SOFT 4M	87	DM43	FEDERDECKEL PM4	120
OS70AW--	RAHMEN SOFT 7M	87	DM44	ABDECKUNG DEKORATIV PM4	120
RAHMEN PURE OP			DM73	FEDERDECKEL PM7	120
OP20--	RAHMEN PURE 2M	90	DM74	ABDECKUNG DEKORATIV PM7	120
OP24--	RAHMEN PURE 2x2M	90	DM75	ABDECKUNG DEKORATIV PM72	121
OP26--	RAHMEN PURE 3x2M	90	HM30	RECHTECKDOSE HOHLWAND VM3	122
OP28	RAHMEN PURE 4x2M	90	HM40	RECHTECKDOSE HOHLWAND VM4	122
OP30--	RAHMEN PURE 3M	91	HM70	RECHTECKDOSE HOHLWAND VM7	122
OP40--	RAHMEN PURE 4M	91	HM72	RECHTECKDOSE HOHLWAND VM72	122
OP70--	RAHMEN PURE 7M	91	BM30	RECHTECKDOSE BETONWAND BM3	123
OP13--	RAHMEN PURE 1/3M	91	BM40	RECHTECKDOSE BETONWAND BM4	123
OP23--	RAHMEN PURE 2/3M	91	BM70	RECHTECKDOSE BETONWAND BM7	123
RAHMEN LINE OL			BM80	BEFESTIGUNGSELEMENT FÜR DOSEN BM	123
OL20--	RAHMEN LINE 2M	94	BM82	DISTANZPROFIL FÜR DOSEN	123
OL24--	RAHMEN LINE 2x2M	94	ABZWEIGDOSEN		
OL26--	RAHMEN LINE 3x2M	94	DW10	ABZWEIGDOSE RUND ZIEGELWAND DSM78	126
OL28--	RAHMEN LINE 4x2M	94	HW10	ABZWEIGDOSE RUND HOHLWAND SM78x45	126
OL29--	RAHMEN LINE 5x2M	94	DE23	ABDECKUNG DEKORATIV SM78	126
OL30--	RAHMEN LINE 3M	95	DE24	FEDERDECKEL 78	126
OL40--	RAHMEN LINE 4M	95	HW20	ABZWEIGKASTEN ZIEGELWAND SM105x105	126
OL70--	RAHMEN LINE 7M	95	VERDRAHTUNGSZUBEHÖR		
OL10--	RAHMEN LINE 1/2M	95	UW10--	DOSENKLEMMLEISTEN GESCHLOSSEN PC 2x2,5 mm ² 10P	128
OL13--	RAHMEN LINE 1/3M	95	UW11--	DOSENKLEMMLEISTEN GESCHLOSSEN PC 2x4 mm ² 10P	128
OL23--	RAHMEN LINE 2/3M	95	UW12--	DOSENKLEMMLEISTEN GESCHLOSSEN PC 2x6 mm ² 10P	128
RAHMEN SOFT OS			UW15--	DOSENKLEMMLEISTEN PA 2x2,5 mm ² 12P	128
OS20--	RAHMEN SOFT 2M	98	UW16--	DOSENKLEMMLEISTEN PA 2x4 mm ² 12P	128
OS24--	RAHMEN SOFT 2x2M	98	UW17--	DOSENKLEMMLEISTEN PA 2x6 mm ² 12P	128
OS26--	RAHMEN SOFT 3x2M	98	UW29--	LÜSTER-KLEMMLEISTEN PP 1.0-4.0 mm ² 12P	128
OS28--	RAHMEN SOFT 4x2M	98	UW30--	LÜSTER-KLEMMLEISTEN PP 1.5-6.0 mm ² 12P	128
OS30--	RAHMEN SOFT 3M	99	UW31--	LÜSTER-KLEMMLEISTEN PP 2.5-10 mm ² 12P	128
OS40--	RAHMEN SOFT 4M	99	UW32--	LÜSTER-KLEMMLEISTEN PP 4-16 mm ² 12P	128
OS70--	RAHMEN SOFT 7M	99	UW25--	LÜSTER-KLEMMLEISTEN PA 1.0-4.0 mm ² 12P	129
OS72--	RAHMEN SOFT 2x7M	99	UW26--	LÜSTER-KLEMMLEISTEN PA 1.5-6.0 mm ² 12P	129
OS10--	RAHMEN SOFT 1/2M	99	UW27--	LÜSTER-KLEMMLEISTEN PA 1.5-6.0 mm ² 12P	129
OS13--	RAHMEN SOFT 1/3M	99	UW28--	LÜSTER-KLEMMLEISTEN PA 1.5-6.0 mm ² 12P	129
OS23--	RAHMEN SOFT 2/3M	99	UW40--	STECKKLEMMEN PA 1,5 mm ² 3P	129
MONTAGETRÄGER NM			UW41--	STECKKLEMMEN PA 1,5 mm ² 5P	129
NM20	MONTAGETRÄGER MIT KRALLEN 2M	104	UW42--	STECKKLEMMEN PA 1,5 mm ² 8P	129
NM21	MONTAGETRÄGER OHNE SCHRAUBEN 2M	104	UW45--	STECKKLEMMEN PA 2,5 mm ² 3P	129
NM24	MONTAGETRÄGER METALL MIT KRALLEN 2M	104	UW46--	STECKKLEMMEN PA 2,5 mm ² 4P	129
NM25	MONTAGETRÄGER METALL OHNE SCHRAUBEN 2M	104	UW47--	STECKKLEMMEN PA 2,5 mm ² 5P	129
NM30	MONTAGETRÄGER MIT SCHRAUBEN 3M	105	UW50--	STECKKLEMMEN PA 2,5 mm ² 2/1P	129
NM40	MONTAGETRÄGER MIT SCHRAUBEN 4M	105			
NM70	MONTAGETRÄGER MIT SCHRAUBEN 7M	105			
NM72	MONTAGETRÄGER MIT SCHRAUBEN 2x7M	105			
NM10	MONTAGETRÄGER MIT KRALLEN 1/2M	106			
NM11	MONTAGETRÄGER OHNE SCHRAUBEN 1/2M	106			
NM23	MONTAGETRÄGER MIT KRALLEN 2/3M	106			
NM32	MONTAGETRÄGER MIT SCHRAUBEN 2/3M	106			

Vertrieb

LOGIQ

Typ	Bezeichnung	Seite	Typ	Bezeichnung	Seite
AUFPUTZGEHÄUSE CUBO IP20 AC			SCHALTER SQ		
AC11--	AUFPUTZGEHÄUSE NO CUBO MIT BODEN IP20 1M	132	SQ10--XO	SCHALTER 1-POLIG 10AX 250V~	158
AC21--	AUFPUTZGEHÄUSE NO CUBO MIT BODEN IP20 2M	132	SQ10--INXO	SCHALTER 1-POLIG 10AX 250V~ __ IN	158
AC41--	AUFPUTZGEHÄUSE NO CUBO MIT BODEN IP20 4M	132	SQ11--XO	TASTER 1-POLIG 10A 250V~	158
AC61--	AUFPUTZGEHÄUSE NO CUBO MIT BODEN IP20 6M	132	SQ11--IN01XO	TASTER 1-POLIG 10A 250V~ __ IN 01	158
AUFPUTZGEHÄUSE CUBO IP55 AQ			SQ11--IN02XO	TASTER 1-POLIG 10A 250V~ __ IN 02	159
AQ20--	AUFPUTZGEHÄUSE NO CUBO IP55 2M	133	SQ22--IN03XO	SCHALTER 2-POLIG 16AX 250V~ __ IN 03	159
AQ22--	AUFPUTZGEHÄUSE NO CUBO IP55 2x2M	133	SQ50--XO	SCHALTER SERIEN 10AX 250V~	159
AQ30--	AUFPUTZGEHÄUSE NO CUBO IP55 3M	133	SQ51--XO	TASTER SERIEN 10A 250V~	159
AQ21--	UNTERPUTZGEHÄUSE PO CUBO IP55 2M	134	SQ52--NT09XO	SCHALTER JALOUSIE 10AX 250V~ __ NT 09	159
AQ31--	UNTERPUTZGEHÄUSE PO CUBO IP55 3M	134	SQ53--NT09XO	TASTER JALOUSIE 10A 250V~ __NT 09	159
BRÜSTUNGSKANÄLE ALU MA			SQ60--XO	WECHSELSCHALTER 10AX 250V~	159
RT10	ADAPTER MA 92	135	SQ63--XO	DOPPELWECHSELSCHALTER 10AX 250V~	160
RT12--	RAHMEN MA 92 2/3M	135	SQ70--XO	KREUZSCHALTER 10AX 250V~	160
RT14--	RAHMEN MA 92 4M	135	BELEUCHTUNG IA		
RT17--	RAHMEN MA 92 7M	135	IA10--	GLÜHLAMPE 230V~ 0,34W	161
RT20--	KANALUNTERTEIL MA 130x65	136	IA20--	LED-LAMPE 230V~ AC/DC 0,4W	161
RT21--	KANALUNTERTEIL MA 165x65	136	IA21--	LED-LAMPE 24V AC/DC 0,2W	161
RT25--	FRONTABDECKUNG MA 92	136	IA22--	LED-LAMPE 12V AC/DC 0,1W	161
RT30	TRENNWAND MA 43	136	STECKDOSEN VQ		
RT31	TRENNWAND MA 43 AL	136	VQ10--XO	STECKDOSE SCHUKO 2P+E 16A 250V~ __ XO	164
RT32	TRENNWAND MA 43 AL DOPPELT	136	VQ11--XO	STECKDOSE SCHUKO+KLAPPDECKEL 2P+E 16A 250V~ __ XO	164
RT35--	ENDSTÜCK MA 130x65	137	VQ12--XO	STECKDOSE SCHUKO 2P+E 16A 250V~ BV __ XO	164
RT36--	ENDSTÜCK MA 165x65	137	VQ13--XO	STECKDOSE SCHUKO+KLAPPDECKEL 2P+E 16A 250V~ BV __ XO	164
RT38	VERBINDUNGSSTÜCK MA 65	137	VQ16--	STECKDOSE SCHUKO DOPPELT 2P+E 16A 250V~	164
RT40--	UNIVERSALECK MA 130x65	137	KOMMUNIKATION KQ		
RT41--	UNIVERSALECK MA 165x65	137	KQ10--XO	STECKDOSE TV-EINZELDOSE 0dB	165
RT42	ERDUNGSKLEMME MA 2x A6.3	137	KQ11--XO	STECKDOSE TV-R-ENDDOSE 1dB	165
RT43--	FLACHWINKEL MA 130x65	138	KQ12--XO	STECKDOSE TV-R-DURCHGANGSDOSE 10dB	165
RT44--	FLACHWINKEL MA 165x65	138	KQ16--XO	STECKDOSE SAT-TV-R-ENDDOSE 3dB	165
RT45--	T-STÜCK MA 130x65	138	KQ22--XO	STECKDOSE AUDIO 2xRCA	166
RT46--	T-STÜCK MA 165x65	138	KQ23--XO	STECKDOSE AUDIO FÜR LAUTSPRECHER	166
RT50--	BEFESTIGUNGSPLATTE EINFACH MA 130x65	139	KQ36--XO	STECKDOSE TEL KS RJ11 6/4	166
RT51--	BEFESTIGUNGSPLATTE DOPPELT MA 130x65	139	KQ37--XO	STECKDOSE CAT5e KS RJ45 8/8	166
RT52--	SERVICESAULE MA 130x65x500	139	KQ38--XO	STECKDOSE TEL KS DOPPELT 2x RJ11 6/4	166
RT53--	SERVICESAULE DOPPELTI MA 130x65x500	139	KQ39--XO	STECKDOSE CAT5e KS DOPPELT 2x RJ45 8/8	166
BODENDOSEN MT			KQ35--XO	STECKDOSE TEL LT RJ11 6/4	166
RB50	UNTERSATZ FÜR BODENDOSEN 4M	141	KQ40--XO	STECKDOSE CAT6s KS RJ45 8/8 SLIM	167
RB60	EINSATZ FÜR BODENDOSEN 4M	141	KQ41--XO	STECKDOSE CAT6s KS DOPPELT 2x RJ45 8/8 SLIM	167
RB65S1	DECKEL FÜR BODENDOSEN 4M	141	ELEKTRONIK EQ		
RB51	UNTERSATZ FÜR BODENDOSEN 7M	141	EQ15--XO	WECHSELDIMMER RL 400W	168
RB61	EINSATZ FÜR BODENDOSEN 7M	141	EQ16--XO	WECHSELDIMMER RLC 400W	168
RB66S1	DECKEL FÜR BODENDOSEN 7M	141	EQ19--XO	WECHSELDIMMER LED 100W	168
RB52	UNTERSATZ FÜR BODENDOSEN 2X7M	142	EQ32--XO	IR-SCHALTER 5A 230V~	170
RB62	EINSATZ FÜR BODENDOSEN 2X7M	142	EQ35--XO	HEIZUNGSTHERMOSTAT 10A 230V~	170
RB67S2	DECKEL FÜR BODENDOSEN 2X7M	142	EQ36--XO	HEIZUNGS-/KÜHLUNGSTHERMOSTAT 5A 230V~	170
RB53	UNTERSATZ FÜR BODENDOSEN 4X7M	142	EQ37--XO	THERMOSTAT BODENHEIZUNG 16A 230V~	171
RB62	EINSATZ FÜR BODENDOSEN 2X7M	142	EQ68--	LADEGERÄT USB 5V 3,0A	171
RB68S2	DECKEL FÜR BODENDOSEN 4X7M	142	ZUBEHÖR PQ		
RB55S1	BODENDOSE FÜR DOPPELBODEN MIT DECKEL 4M	143	PQ10--XO	BLENDE	172
RB60	EINSATZ FÜR BODENDOSEN 4M	143	PQ30--	DECKEL TAE/TDO	172
RB56S1	BODENDOSE FÜR DOPPELBODEN MIT DECKEL 7M	144	RAHMEN OQ		
RB61	EINSATZ FÜR BODENDOSEN 7M	144	OQ10--	RAHMEN LOGIQ 1	173
RB57S2	BODENDOSE FÜR DOPPELBODEN MIT DECKEL 2X7M	144	OQ20--	RAHMEN LOGIQ 2	173
RB62	EINSATZ FÜR BODENDOSEN 2X7M	144	OQ30--	RAHMEN LOGIQ 3	174
RB58S2	BODENDOSE FÜR DOPPELBODEN MIT DECKEL 4X7M	144	OQ40--	RAHMEN LOGIQ 4	174
RB62	EINSATZ FÜR BODENDOSEN 2X7M	144	OQ50--	RAHMEN LOGIQ 5	174
RB10	ADAPTER FÜR DIN-LEISTE 35 mm 1M	145			
RB11	ADAPTER FÜR DIN-LEISTE 35 mm 2M	145			

ökonomik

Typ	Bezeichnung	Seite	Typ	Bezeichnung	Seite
SCHALTER SE			DECKEL PA		
SE10	SCHALTER 1-POLIG 10AX 250V-	186	PE10--	DECKEL TV-R 2P/3P	202
SE11	TASTER 1-POLIG 10A 250V-	186	PE20--	DECKEL KS EINFACH	202
SE22	SCHALTER 2-POLIG 16AX 250V-	186	PE21--	DECKEL KS/PD DOPPELT	202
SE50	SCHALTER SERIEN 10AX 250V-	186	PE30--	DECKEL TAE/TDO	202
SE51	TASTER SERIEN 10A 250V-	187	ELEKTRONIK EE		
SE52	SCHALTER JALOUSIE 10AX 250V-	187	EE15	DIMMER DREH-WECHSEL RL 400W	203
SE53	TASTER JALOUSIE 10A 250V-	187	EE16	DIMMER DREH-WECHSEL RLC 400W	203
SE60	SCHALTER WECHSEL 10AX 250V-	187	EE19	DIMMER DREH-WECHSEL LED 100W	204
SE63	SCHALTER DOPPEL AUS/WECHSEL 10AX 250V-	187	EE32	IR SCHALTER 5A 230V-	204
SE70	SCHALTER KREUZ 10AX 250V-	187	EE67	LADEGERÄT USB 5V 2,4A	204
SE10	SCHALTER 1-POLIG 10AX 250V-	188	EE15--	DIMMER DREH-WECHSEL RL 400W	205
SE10--IN	SCHALTER 1-POLIG 10AX 250V- IN	88	EE16--	DIMMER DREH-WECHSEL RLC 400W	205
SE11	TASTER 1-POLIG 10A 250V-	188	EE19--	DIMMER DREH-WECHSEL LED 100W	205
SE11--TI50	TASTER 1-POLIGO 10A 250V- TI 50	188	EE32--	IR SCHALTER 5A 250V-	205
SE11--TI51	TASTER 1-POLIGO 10A 250V- TI 51	188	EE67--	LADEGERÄT USB 5V 2,4A	206
SE11--IL	TASTER 1-POLIG 10A 250V- IL	188	DECKEL ELEKTRONIK PE		
SE22--IN03	SCHALTER 2-POLIG 10AX 250V- IN 03	188	PE41--	DECKEL FÜR DIMMER Ø6	208
SE50	SCHALTER SERIEN 10AX 250V-	189	PE32--	DECKEL IR-BEWEGUNGSMELDER	208
SE51	TASTER SERIEN 10A 250V-	189	PE67--	DECKEL LADEGERÄT USB	208
SE52--NT09	SCHALTER JALOUSIE 10AX 250V- NT 09	189	ZUBEHÖR AE		
SE53--NT09	TASTER JALOUSIE 10A 250V- NT 09	189	AE10--	BLLENDE	209
SE60	SCHALTER WECHSEL 10AX 250V-	189	AE20--	HERDANSCHLUßDOSE 3P+N+E 5x4mm ²	209
SE63	SCHALTER DOPPEL AUS/WECHSEL 10AX 250V-	189	AE30--	AUFPUTZGEHÄUSE 1	209
SE70	SCHALTER KREUZ 10AX 250V-	189	AE31--	AUFPUTZGEHÄUSE DOPPELSTECKDOSE	209
WIPPEN TE			AE50--	TAPETENSCHUTZ	210
TE10--	WIPPE NORMAL	190	AE51--	KINDERSCHUTZ KS	210
TE10--IN	WIPPE NORMAL IN	190	RAHMEN OE		
TE13--IL	WIPPE MIT NAMENSCHILD	190	OE10--	RAHMEN EKONOMIK 1	211
TE10--	WIPPE SERIEN	190	OE20--	RAHMEN EKONOMIK 2 HORIZONTAL	211
BELEUCHTUNG IA			OE21--	RAHMEN EKONOMIK 2 VERTIKAL	211
IA10--	GLÜHLAMPE 230V- 0,34W	191	OE30--	RAHMEN EKONOMIK 3 HORIZONTAL	211
IA20--	LED-LAMPE 230V AC/DC 0,4W	191	OE31--	RAHMEN EKONOMIK 3 VERTIKAL	212
IA21--	LED-LAMPE 24V AC/DC 0,2W	191	OE40--	RAHMEN EKONOMIK 4 HORIZONTAL	212
IA22--	LED-LAMPE 12V AC/DC 0,1W	191	OE41--	RAHMEN EKONOMIK 4 VERTIKAL	212
STECKDOSEN VE			OE50--	RAHMEN EKONOMIK 5 HORIZONTAL	212
VE10--XO	STECKDOSE SCHUKO 2P+E 16A 250V- XO	194	OE90--	DEKORATIV RAHMEN COLOR	213
VE11--XO	STECKDOSE SCHUKO+DECKEL 2P+E 16A 250V- XO	194	fontana		
VE12--XO	STECKDOSE SCHUKO 2P+E 16A 250V- BV XO	194	Typ	Bezeichnung	Seite
VE13--XO	STECKDOSE SCHUKO+KLAPPDECKEL 2P+E 16A 250V- BV XO	194	SCHALTER SF		
VE10--	STECKDOSE SCHUKO 2P+E 16A 250V-	194	SF10--	SCHALTER 1-POLIG IP44 10AX 250V-	216
VE11--	STECKDOSE SCHUKO+KLAPPDECKEL 2P+E 16A 250V-	194	SF10--TI	SCHALTER 1-POLIG IP44 10AX 250V- TI	216
VE12--	STECKDOSE SCHUKO 2P+E 16A 250V- BV	194	SF11--TI	TASTER 1-POLIG IP44 10A 250V- TI	216
VE13--	STECKDOSE SCHUKO+KLAPPDECKEL 2P+E 16A 250V- BV	194	SF20--	SCHALTER 2-POLIG IP44 10AX 250V-	216
VE40--XO	STECKDOSE FRANZÖSISCH 2P+E 16A 250V- XO	195	SF50--	SCHALTER SERIEN IP44 10AX 250V-	217
VE41--XO	STECKDOSE FRANZÖSISCH+KLAPPDECKEL 2P+E 16A 250V- XO	195	SF51--	TASTER SERIEN IP44 10A 250V-	217
VE42--XO	STECKDOSE FRANZÖSISCH 2P+E 16A 250V- BV XO	195	SF60--	SCHALTER WECHSEL IP44 10AX 250V-	217
VE43--XO	STECKDOSE FRANZÖSISCH+KLAPPDECKEL 2P+E 16A 250V- BV XO	195	SF60--TI	SCHALTER WECHSEL IP44 10AX 250V- TI	217
VE40--	STECKDOSE FRANZÖSISCH 2P+E 16A 250V-	195	SF63--	SCHALTER DOPPELT AUS/WECHSEL IP44 10AX 250V-	217
VE41--	STECKDOSE FRANZÖSISCH+KLAPPDECKEL 2P+E 16A 250V-	195	SF70--	SCHALTER KREUZ IP44 10AX 250V-	217
VE42--	STECKDOSE FRANZÖSISCH 2P+E 16A 250V- BV	195	STECKDOSEN VF		
VE43--	STECKDOSE FRANZÖSISCH+KS+KLAPPDECKEL 2P+E 16A 250V- BV	195	VF10--	STECKDOSE SCHUKO+KLAPPDECKEL IP44 2P+E 16A 250V-	218
VE16--	STECKDOSE SCHUKO DOPPELT 2P+E 16A 250V-	196	VF12--	STECKDOSE SCHUKO+KLAPPDECKEL IP44 2P+E 16A 250V- BV	218
VE46--	STECKDOSE FRANZÖSISCH DOPPELT 2P+E 16A 250V-	196	SETS CF		
VE30--	STECKDOSE 2P 16A 250V-	196	CF10--	SET STECKDOSE SCHUKO DOPPELT HORIZONTAL IP44 2x2P+E 16A 250V-	219
KOMMUNIKATION KE			CF11--	SET STECKDOSE SCHUKO DOPPELT VERTIKAL IP44 2x2P+E 16A 250V-	219
KE11	STECKDOSE TV-R-ENDDOSE 1dB	197	CF12--	SET STECKDOSE SCHUKO+SCHALTER WECHSEL HORIZONTAL IP44 16A + 10AX 250V-	219
KE12	STECKDOSE TV-R-DURCHGANGSDOSE 10dB	197	CF13--	SET STECKDOSE SCHUKO+SCHALTER WECHSEL VERTIKAL IP44 16A + 10AX 250V-	220
KE16	STECKDOSE SAT-TV-R-ENDDOSE 3dB	197	CF14--	SET STECKDOSE SCHUKO DOPPELT HORIZONTAL IP44 2x2P+E 16A 250V- BV	220
KE36	STECKDOSE TEL KS RJ11 6/4	197	CF15--	SET STECKDOSE SCHUKO DOPPELT VERTIKAL IP44 2P+E 16A 250V- BV	220
KE37	STECKDOSE CAT5e KS RJ45 8/8	198	CF16--	SET STECKDOSE SCHUKO+SCHALTER WECHSEL HORIZONTAL IP44 16A + 10AX 250V- BV	220
KE40	STECKDOSE CAT6s KS RJ45 8/8 SLIM	198	CF17--	SET STECKDOSE SCHUKO+SCHALTER WECHSEL VERTIKAL IP44 16A + 10AX 250V- BV	220
KE38	STECKDOSE TEL KS DOPPELT 2x RJ11 6/4	198	ZUBEHÖR AF		
KE39	STECKDOSE CAT5e KS DOPPELT 2x RJ45 8/8	198	AF10--	ABZWEIGKASTEN IP44 RN01	221
KE41	STECKDOSE CAT6s KS DOPPELT 2x RJ45 8/8 SLIM	198	AF20--	ABZWEIGKASTEN IP55 ND01	221
KE45	ADAPTER KS EINFACH	198			
KE46	ADAPTER KS DOPPELT	199			
KE47	ADAPTER PD DOPPELT	199			
KE10--	STECKDOSE TV-EINZELDOSE 0dB	200			
KE11	STECKDOSE TV-R-ENDDOSE 1dB	200			
KE12	STECKDOSE TV-R-DURCHGANGSDOSE 10dB	200			
KE16	STECKDOSE SAT-TV-R-ENDDOSE 3dB	200			
KE22--	STECKDOSE AUDIO 2xRCA	200			
KE23--	STECKDOSE AUDIO FÜR LAUTSPRECHER	200			
KE36	STECKDOSE TEL KS RJ11 6/4	200			
KE37	STECKDOSE CAT5e KS RJ45 8/8	201			
KE40--	STECKDOSE CAT6s KS RJ45 8/8 SLIM	201			
KE38	STECKDOSE TEL KS DOPPELT 2x RJ11 6/4	201			
KE39	STECKDOSE CAT5e KS DOPPELT 2x RJ45 8/8	201			
KE41--	STECKDOSE CAT6s KS DOPPELT 2x RJ45 8/8 SLIM	201			
KE35--	STECKDOSE TEL LT RJ11 6/4 1M	201			



TEM

On | Off and everything in between

100% ELEKTRIČEN

www.tem.si



TEM

On|Off and everything in between



[www](http://www.tem.si)



TEM

TEM ČATEŽ d.o.o.
Čatež 13, 8212 VELIKA LOKA
SLOVENIJA
tem@tem.si
www.tem.si

T +386(0)7 348 99 00

TEM

DE

www.tem.si

