

TEM

On | Off and everything in between



2022

MODUL



MODUL
LINE



MODUL
SOFT



MODUL
PURE

38

LOGIQ



146

ekonomik



176

fontana



214



TEM

On | Off and everything in between



Mi smo vodeći proizvođač sklopki i utičnica u regiji. Već pola stoljeća svojim korisnicima nudimo pozitivno iskustvo, jednostavnu instalaciju i upotrebu proizvoda te široku paletu boja i materijala koji će zadovoljiti i najzahtjevnije klijente.

We are the leading manufacturer of switches and sockets in the region. For half a century, we have been providing our users a positive and easy experience, simple installation and use of products, a wide range of colours and materials, which convince even the most demanding.

TEM

Dobro došli u MODUL obitelj

Welcome to the MODUL family

Dodajte svojem ambijentu osobnu notu i pokažite svoj stil
sklopkama i utičnicama iz MODUL obitelji.

*Give your ambience a personal touch and show off your style with
switches and sockets from MODUL family.*

otkrijte nove dimenzije

discovering new insights



MODUL

LINE



MODUL

SOFT



MODUL

PURE

1

2

MODUL
LINE



MODUL
SOFT



MODUL
PURE

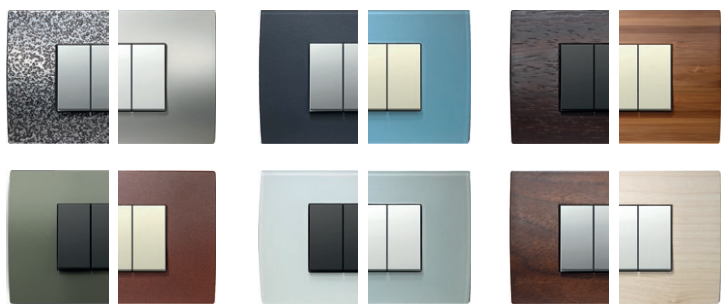

metal

staklo

drvo

3

4

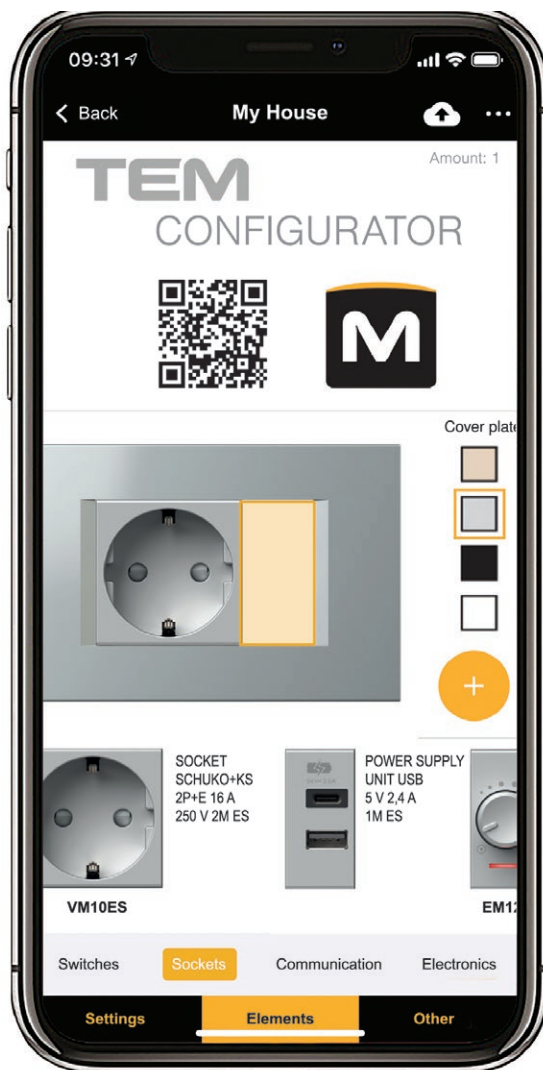

MODUL

LINE

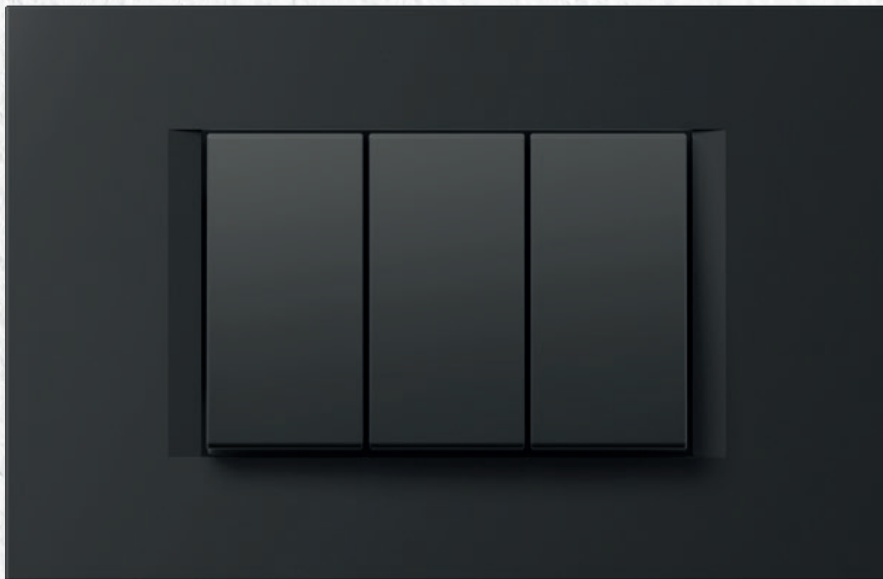

Ravne, glatke linije stvaraju bezvremenski dizajn.

Straight, smooth lines create a timeless design.





MODUL

LINE

PW

IW

ES

AT

SB

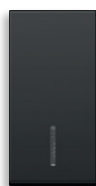

bijela sjajna

bež sjajna

srebrna mat

antracit

crna mat

polar white

ivory white

elox silver

anthracite

*soft touch
black*

Odaberite svoju boju
Select your colour

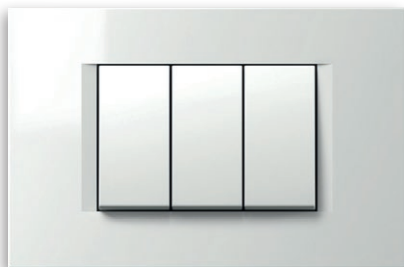

PW bijela sjajna
polar white

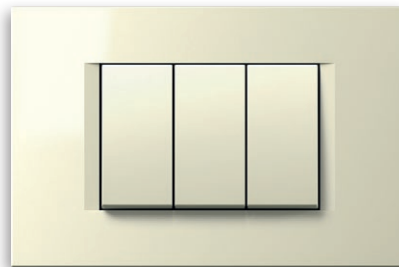

IW bež sjajna
ivory white



SW kamen bijeli
stone white

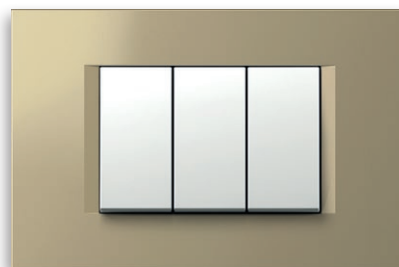

SG zlatna mat
sand gold



ES srebrna mat
elox silver



TI titan
titanium



IB plava mat
impulse blue

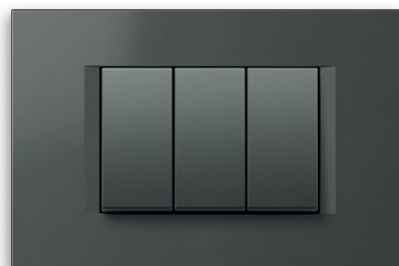

AT antracit
anthracite



NB crna sjajna
night black

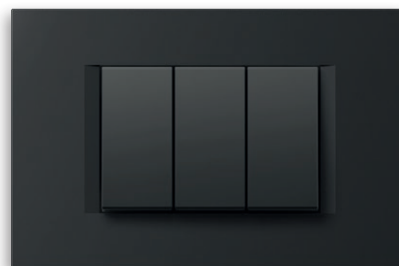

SB crna mat
soft touch black

MODUL

SOFT

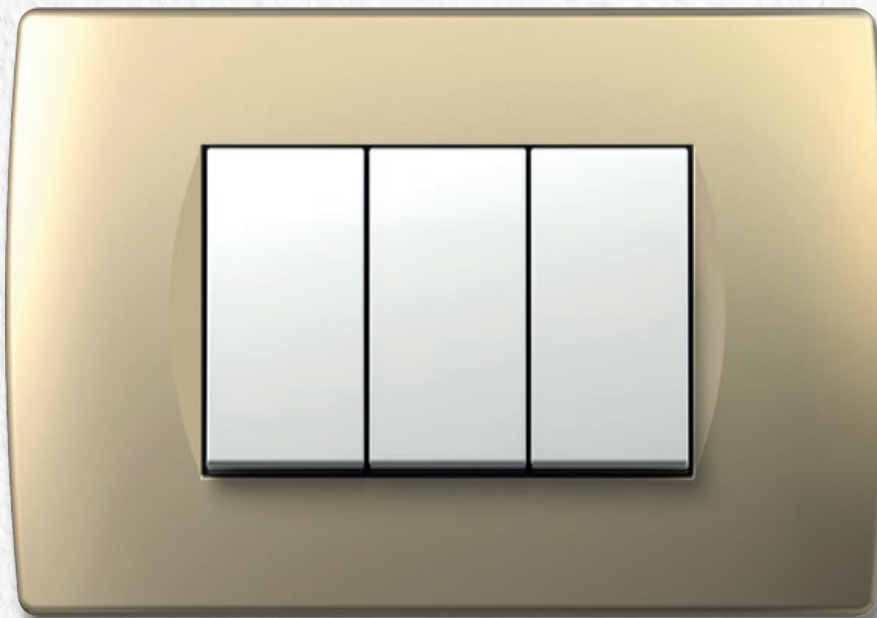

Okrugli oblici i meki prijelazi unose mekoću u Vaš dom.

Rounded shapes and soft transitions bring softness into your home.





MODUL

SOFT

PW



bijela sjajna

polar white

IW



bež sjajna

ivory white

ES



srebrna mat

elox silver

AT



antracit

anthracite

SB



crna mat

*soft touch
black*

Odaberite svoju boju
Select your colour

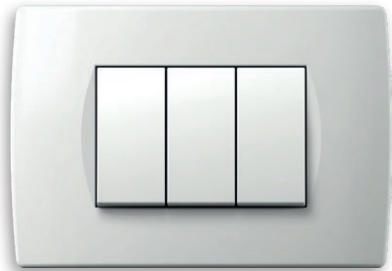

PW bijela sjajna
polar white

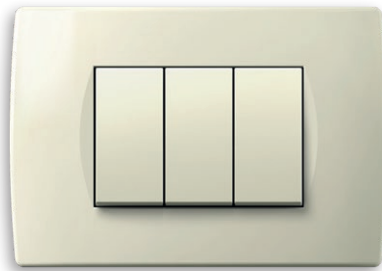

IW bež sjajna
ivory white



ES srebrna mat
elox silver

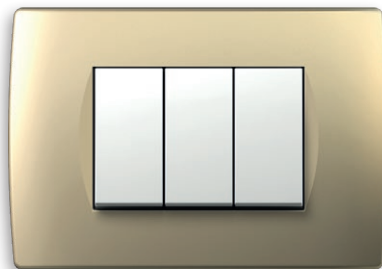

SG zlatna mat
sand gold



WW titan
walnut

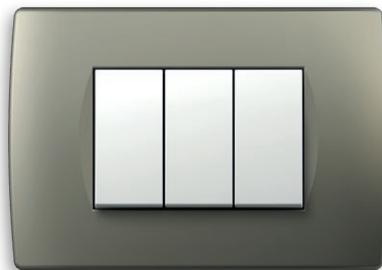

TI titan
titanium



WE wenge
wenge



AT antracit
anthracite



NB crna sjajna
night black



SB crna mat
soft touch black

MODUL

PURE

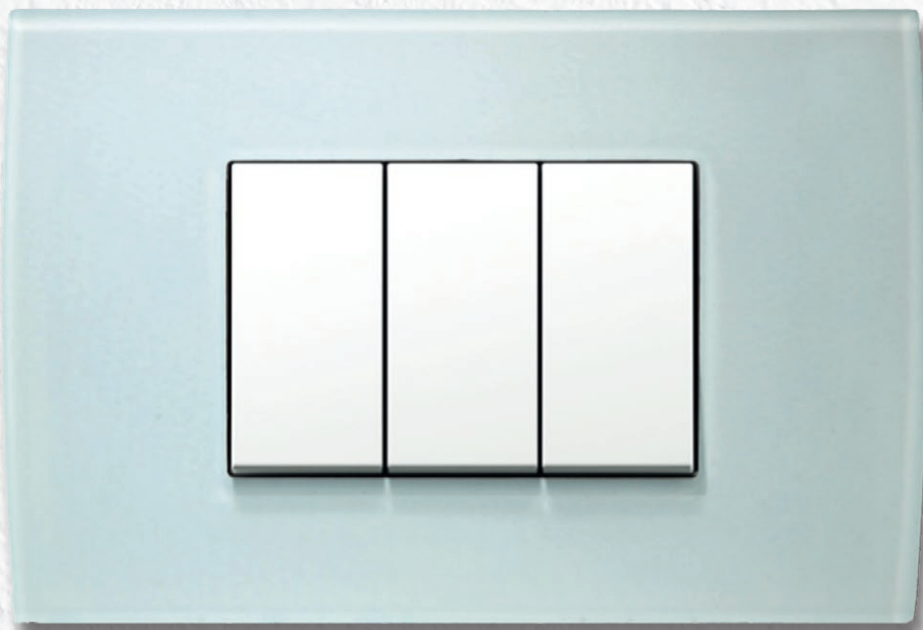

Detalji nadopunjuju cjelokupni ambijent. Neka priroda obogati Vaš prostor drvenim, stakleni i metalnim okvirima.

The details represent the completeness of the entire ambience. Let the nature enrich your space with decorative cover plates made of wood, glass and metal.





MODUL

PURE

PW



bijela sjajna

polar white

IW



bež sjajna

ivory white

ES



srebrna mat

elox silver

AT



antracit

anthracite

SB



crna mat

*soft touch
black*

staklo
glass



GW ledeno bijela
ice white

metal
metal



MH kovani čelik
hammered steel

drvo
wood

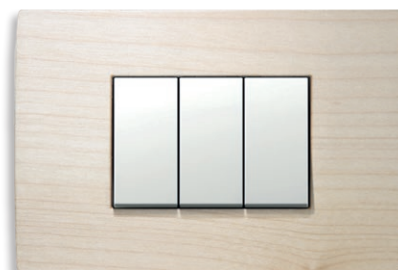

WM javor
maple

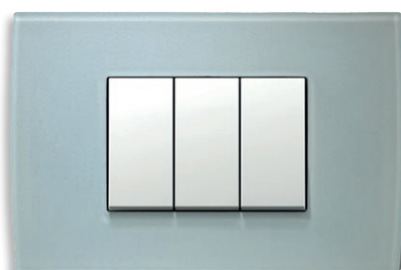

GG ledeno zelena
ice green

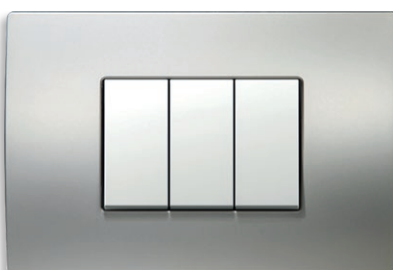

MS satenski srebrna
satın silver



WB bambus
bamboo

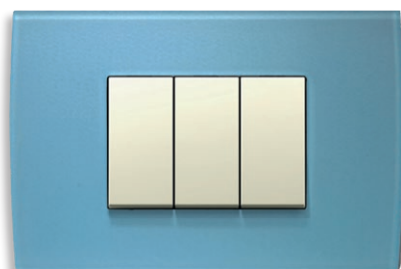

GB ledeno plava
ice blue



MN satenski poniklani
satın nickel



WW orah
walnut

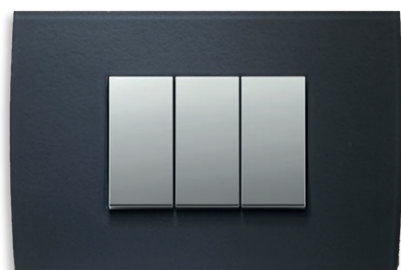

GY ledeno siva
ice grey



ME lijevano željezo
etched iron

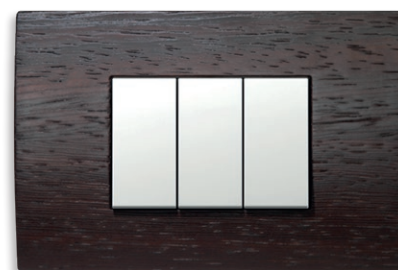

WE wenge
wenge

MODUL

PURE



STAKLO – lagano i sofisticirano.
Neka svježina uđe u Vaš dom.

*GLASS - light and sophisticated.
Let freshness breeze through your home.*





staklo
glass

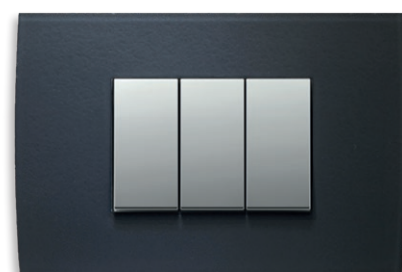
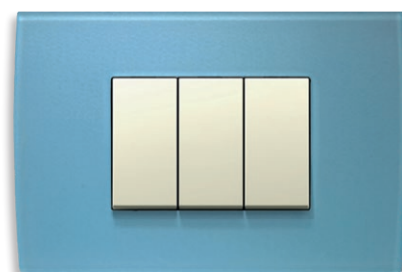
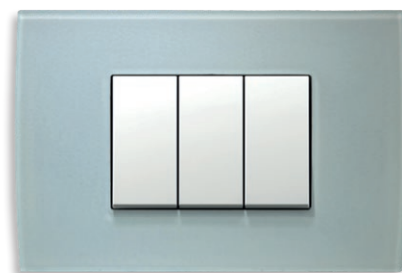

MODUL

PURE



METAL – hladno, ali elegantno.
Prigrbite ovaj iskonski materijal koji
na suptilan način privlači pozornost.

*METAL - cold, yet noble.
Embrace this pristine material and
effortlessly catch attention.*





metal
metal

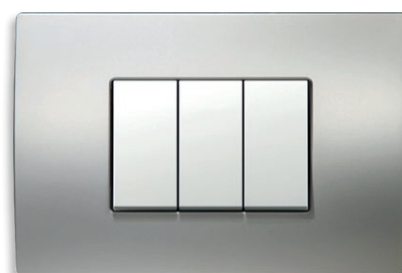

MODUL

PURE



DRVO – raznoliko, ali jedinstveno.
Pustite toplinu prirode u dom.

*WOOD - versatile, yet unique.
Give way to nature's warmth.*





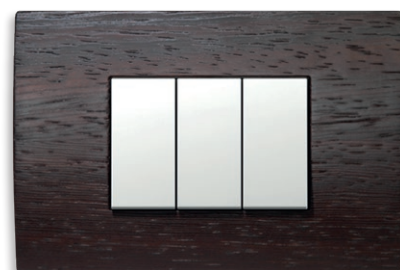

drvo
wood

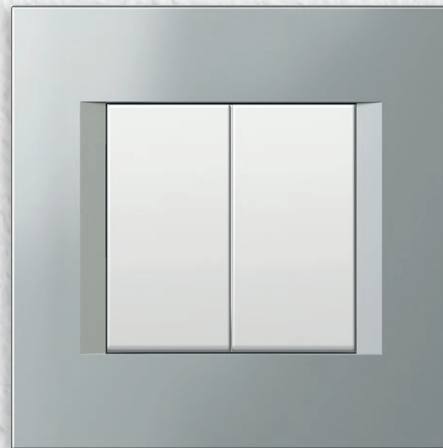





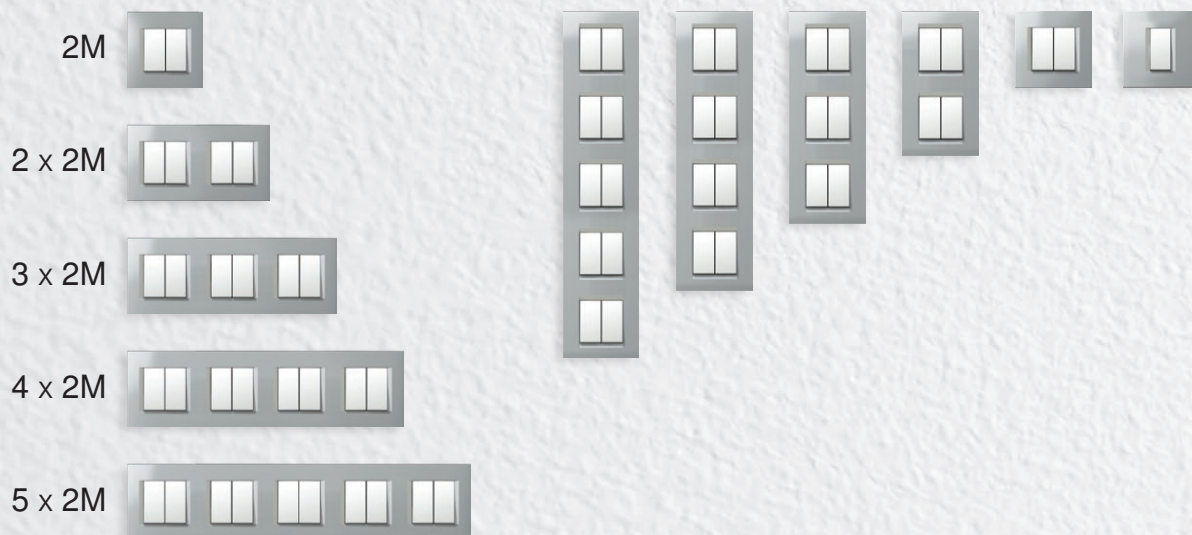
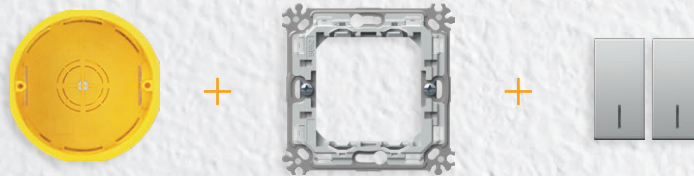

MODUL

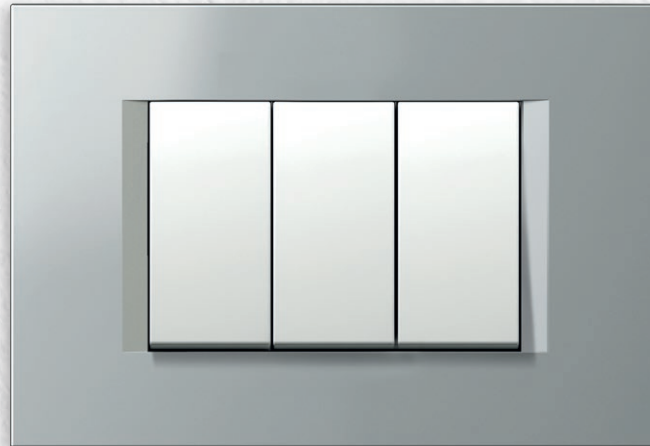
-  LINE
-  SOFT
-  PURE





MODUL

-  LINE
-  SOFT
-  PURE



2 x 7M

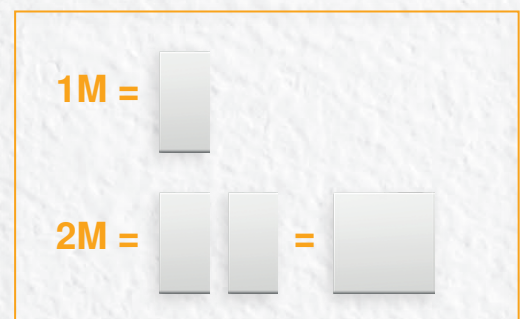

Funkcijski elementi jednostavno se ugrađuju u nosač.
Rješenje „klik-in, klik-out” koje smo smislili za vas smanjit će vrijeme ugradnje. Kontakti spojeva lako su dostupni s prednje strane.

The function elements are easily fitted inside the mounting frame.

The “klik-in, klik-out” solution we have developed for you will reduce installation time. The connection contacts are easily accessible from the front.

klik-in, klik-out

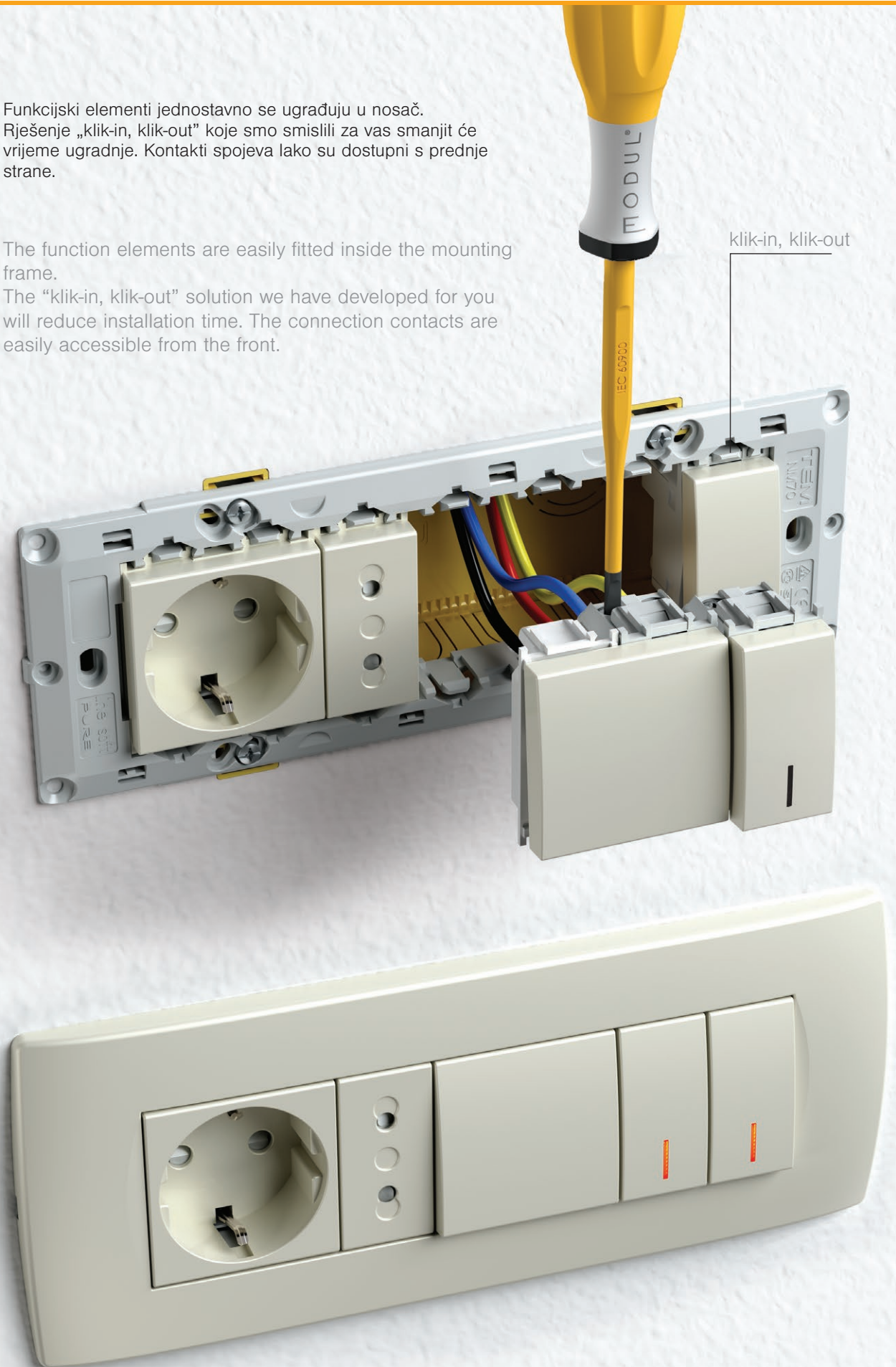

Modul je prikladan za sve vrste zidova te se može upotrebljavati u konvencionalnim šupljim zidovima ili betonskim konstrukcijama. Jednostavno se ugrađuje i omogućuje Vam kombiniranje pravokutnih ili okruglih kutija na odgovarajućoj udaljenosti. Materijali koji se koriste usklađeni su s visokim standardima.

The Modul is suitable for all wall types and can be used in conventional, hollow wall or concrete constructions. It is easy to install and enables you to combine rectangular or round boxes at the proper distances. The materials used are compliant with high standards.



opeka / brick



šuplji zid / hollow wall



beton / concrete

Modul pruža mnogobrojne mogućnosti, čak i s okruglim kutijama. Možete ih kombinirati horizontalno ili vertikalno, zasebno ili u grupama. Metalni ugradbeni okvir daje izvrsnu stabilnost, čak i uz grubu upotrebu, te je prikladan za sve okvire.

The Modul enables a many possibilities even with round boxes. You can combine them horizontally or vertically, individually or in groups. The metal mounting frame ensures excellent stability even with rough use and is suitable for any decorative cover plates.

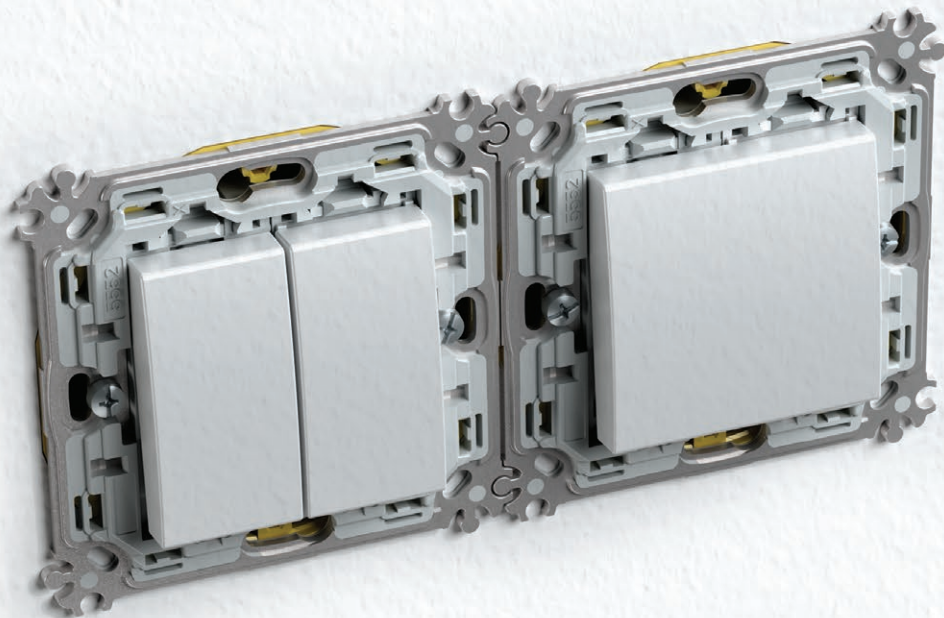



□ PW bijela sjajna
polar white



■ SB crna mat
soft touch black



■ AT antracit
anthracite



□ ES srebrna mat
elox silver



□ IW bež sjajna
ivory white



SIMBOLI SYMBOLS

01	02	03	04	05	06	07	08	09	10	11	12	20	21	22	23
24	25	26	27	28	29	30	31	32	33	34	35	36	37	38	39
					OFF	ON					AC				
40	41	42	43	44	45	46	47	48							

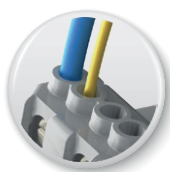
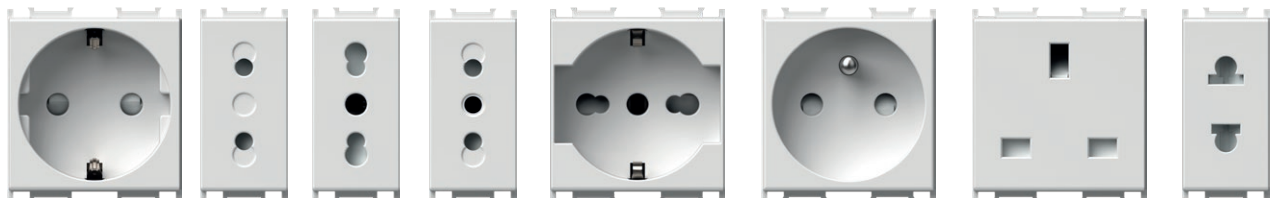

Pouzdana spajanje pri upotrebi žica različitih debljina.

Reliable connection even when different size of wires are used.



Sve su utičnice opremljene sigurnosnim sklopovima koji osiguravaju zaštitu od kontakta s naponom.

All the sockets are equipped with a safety shutters assuring the protection to live contacts.

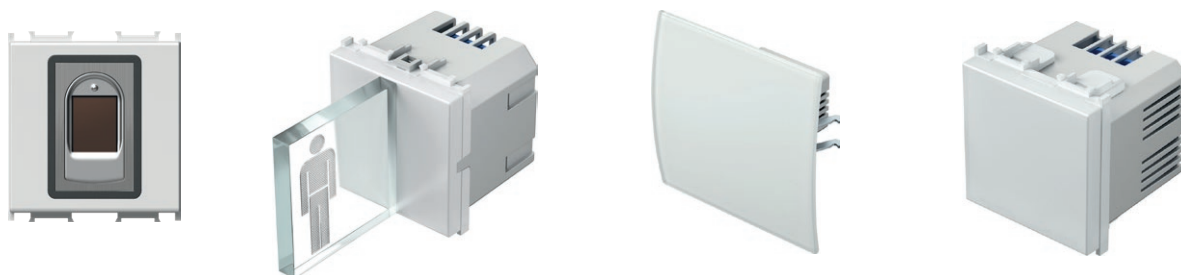
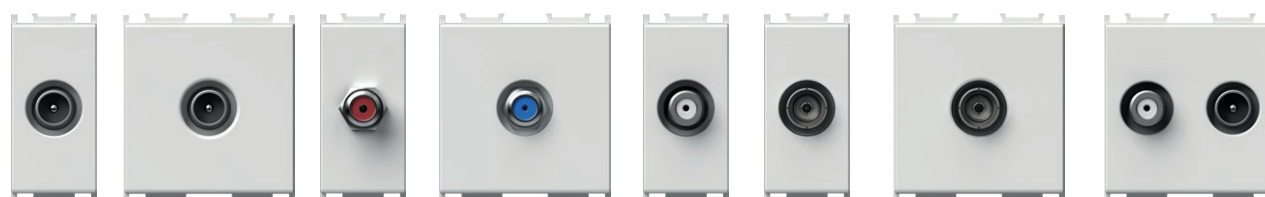
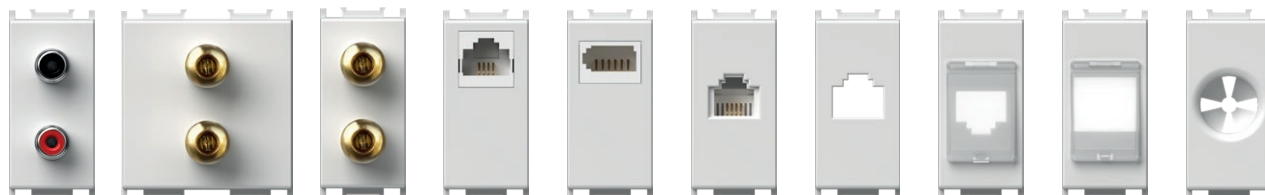

Dugotrajnost sklopki te uskladenost s međunarodnim standardima.

Long-life of switches and adequacy to the international standards.



Sklopka je vrlo pouzdana zahvaljujući srebrnim zakovicama kontakata.

The switch is highly reliable via its silver rivets contacts.





BIOPASS – prekidač na otisak prsta

BIOPASS - fingerprint switch

Otključavanje bez ključeva.

Keyless unlocking.

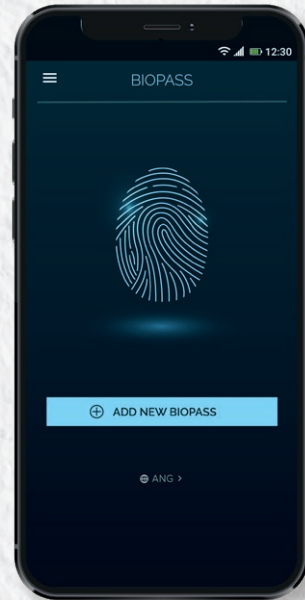

MULTIMEDIJA

MULTIMEDIA

Multimedijski centar koji omogućuje spajanje više komponenta na jednome mjestu.

Multimedia center that allows you to connect a multiple number of components in one place.



TOUCH – univerzalni zatamnivač

TOUCH - universal dimmer

Uključivanje i regulacija osvjjetljenja različitih žarulja

Switching and dimming of different lamps

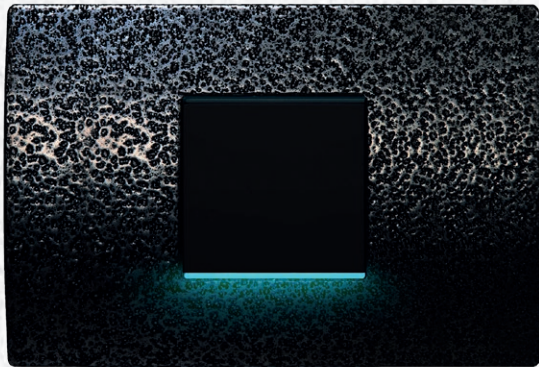

KREIRAJTE VLASTITE PROIZVODE

CREATE YOUR OWN

Kada se naručuje veća količina, okviri i funkcijski elementi mogu se izraditi u boji prema Vašem izboru.

When ordering large quantities, cover plates and function elements can be made in the colour of your choice.



STVORITE JEDINSTVENI PROIZVOD

MAKE IT UNIQUE

Odaberite boju osvjjetljenja koja odgovara ambijentu Vašeg prostora.

Choose a illumination colour and add desired graphic to suit the ambience of your room.



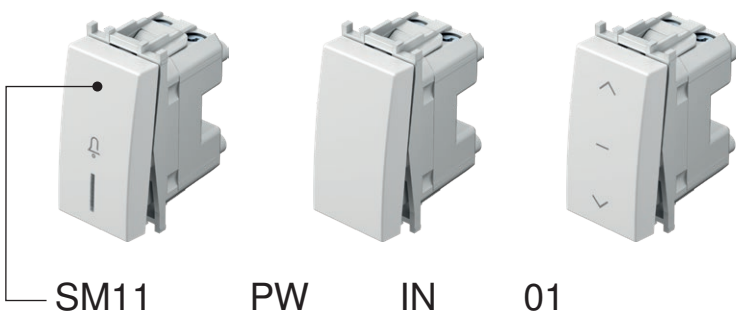

SM11

PW

IN

01

tip type	naziv description	tehnički podaci technical data	veličina size	boja colour	opcijski podaci 1 optional data 1	opcijski podaci 2 optional data 2
SM10	SKLOPKA JEDNOPOLNA SWITCH 1WAY	16AX 250V~	1M	<input type="checkbox"/> PW bijela sjajna polar white	<input type="checkbox"/> NT neutralna neutral	01
SM11	TIPKALO JEDNOPOLNO PUSH BUTTON 1WAY	16A 250V~	1M	<input checked="" type="checkbox"/> SB crna mat soft touch black	<input type="checkbox"/> IN indikator indicator	02
SM12	SKLOPKA JEDNOPOLNA SWITCH 1WAY	20A 250V~	1M	<input checked="" type="checkbox"/> AT antracit anthracite		03
⋮	⋮	⋮	⋮	<input type="checkbox"/> ES srebrna mat elox silver		
⋮	⋮	⋮	⋮	<input type="checkbox"/> IW bež sjajna ivory white		

SKLOPKA JEDNOPOLNA 16AX 250V~ 1M



SM10

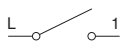

- sklopka bez tipke
 - 16AX 250V~, tip SM10
 - sukladno normi EN 60669-1
 - vijčano pričvršćivanje vodiča presjeka 1,5-2,5 mm²
- SWITCH 1WAY 16AX 250V~ 1M**
- switch without button
 - 16AX 250V~, type SM10
 - in accordance with EN 60669-1
 - screw contacts 1.5-2.5mm²

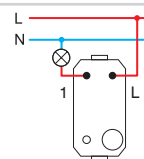

TIPKALO JEDNOPOLNO 16A 250V~ 1M



SM11



- tipkalo bez tipke
 - 16A 250V~, tip SM11
 - sukladno normi EN 60669-1
 - vijčano pričvršćivanje vodiča presjeka 1,5-2,5 mm²
- PUSH BUTTON 1WAY 16A 250V~ 1M**
- push button without button
 - 16A 250V~, type SM11
 - in accordance with EN 60669-1
 - screw contacts 1.5-2.5mm²

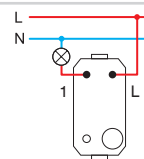

SKLOPKA JEDNOPOLNA 20A 250V~ 1M



SM12

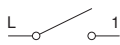

- sklopka bez tipke
 - 20A 250V~, tip SM12
 - sukladno normi EN 60669-1
 - vijčano pričvršćivanje vodiča presjeka 1,5-2,5 mm²
- SWITCH 1WAY 20A 250V~ 1M**
- switch without button
 - 20A 250V~, type SM12
 - in accordance with EN 60669-1
 - screw contacts 1.5-2.5mm²

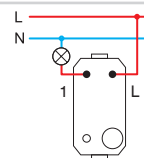

SKLOPKA DVOPOLNA 16AX 250V~ 1M



SM20

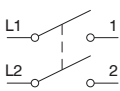

- sklopka bez tipke
 - 16AX 250V~, tip SM20
 - sukladno normi EN 60669-1
 - vijčano pričvršćivanje vodiča presjeka 1,5-2,5 mm²
 - samo u kombinaciji s tipkom TM15
- SWITCH 2POLE 16AX 250V~ 1M**
- switch without button
 - 16AX 250V~, type SM20
 - in accordance with EN 60669-1
 - screw contacts 1.5-2.5mm²
 - only in combination with button TM15

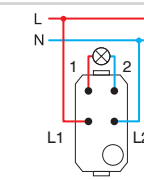

S W I T C H E S S M



SM40

SKLOPKA ŽALUZIJSKA 1-0-2 16AX 250V~ 1M

- sklopka bez tipke
- 16AX 250V~, tip SM40
- sukladno normi EN 60669-1
- vijčano pričvršćivanje vodiča presjeka 1,5-2,5 mm²



SWITCH SHUTTERS 1-0-2 16AX 250V~ 1M

- switch without button
- 16AX 250V~, type SM40
- in accordance with EN 60669-1
- screw contacts 1.5-2.5mm²

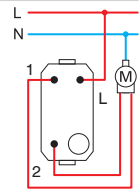

SM41

TIPKALO ŽALUZIJSKO 1-0-2 16A 250V~ 1M

- tipkalo bez tipke
- 16A 250V~, tip SM41
- sukladno normi EN 60669-1
- vijčano pričvršćivanje vodiča presjeka 1,5-2,5 mm²

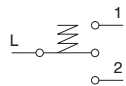

PUSH BUTTON SHUTTERS 1-0-2 16A 250V~ 1M

- push button without button
- 16A 250V~, type SM41
- in accordance with EN 60669-1
- screw contacts 1.5-2.5mm²

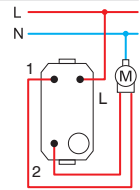

SM60

SKLOPKA IZMJENIČNA 16AX 250V~ 1M

- sklopka bez tipke
- 16AX 250V~, tip SM60
- sukladno normi EN 60669-1
- vijčano pričvršćivanje vodiča presjeka 1,5-2,5 mm²

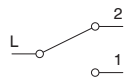

SWITCH 2WAY 16AX 250V~ 1M

- switch without button
- 16AX 250V~, type SM60
- in accordance with EN 60669-1
- screw contacts 1.5-2.5mm²

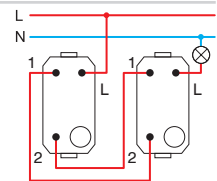

SM61

TIPKALO IZMJENIČNO 16A 250V~ 1M

- tipkalo bez tipke
- 16A 250V~, tip SM61
- sukladno normi EN 60669-1
- vijčano pričvršćivanje vodiča presjeka 1,5-2,5 mm²

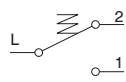

PUSH BUTTON 2WAY 16A 250V~ 1M

- push button without button
- 16A 250V~, type SM61
- in accordance with EN 60669-1
- screw contacts 1.5-2.5mm²

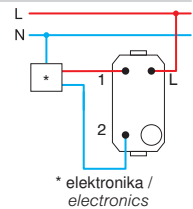

SM70

SKLOPKA KRIŽNA 16AX 250V~ 1M

- sklopka bez tipke
- 16AX 250V~, tip SM70
- sukladno normi EN 60669-1
- vijčano pričvršćivanje vodiča presjeka 1,5-2,5 mm²



SWITCH INTERMEDIATE 16AX 250V~ 1M

- switch without button
- 16AX 250V~, type SM70
- in accordance with EN 60669-1
- screw contacts 1.5-2.5mm²

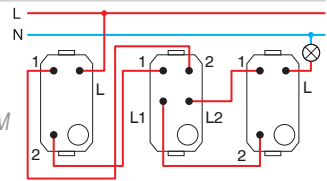

1M = 22,5 x 45
2M = 45 x 45

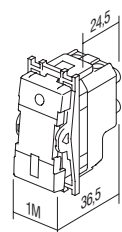
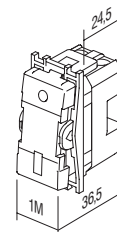



□ PW bijela sjajna
polar white



■ SB crna mat
soft touch black



■ AT antracit
anthracite



□ ES srebrna mat
elox silver



□ IW bež sjajna
ivory white

SKLOPKA JEDNOPOLNA 16AX 250V~ 1M



- SM10PW
- SM10SB
- SM10AT
- SM10ES
- SM10IW

- 16AX 250V~, tip SM10
- sukladno normi EN 60669-1
- vijčano pričvršćivanje vodiča presjeka 1,5-2,5 mm²
- zamjenjiva tipka

SWITCH 1WAY 16AX 250V~ 1M

- 16AX 250V~, type SM10
- in accordance with EN 60669-1
- screw contacts 1.5-2.5 mm²
- replaceable button



SKLOPKA JEDNOPOLNA 16AX 250V~ 1M __ IN

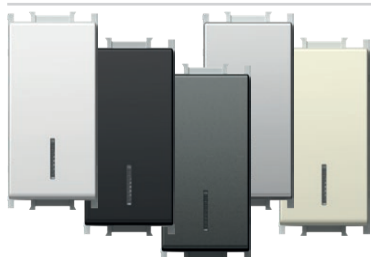

- SM10PWIN
- SM10SBIN
- SM10ATIN
- SM10ESIN
- SM10IWIN

- IN indikator
- 16AX 250V~, tip SM10
- sukladno normi EN 60669-1
- vijčano pričvršćivanje vodiča presjeka 1,5-2,5 mm²
- tinjalica nije ugrađena
- zamjenjiva tipka

SWITCH 1WAY 16AX 250V~ 1M __ IN

- IN indicator
- 16AX 250V~, type SM10
- in accordance with EN 60669-1
- screw contacts 1.5-2.5 mm²
- lamp is not included
- replaceable button



TIPKALO JEDNOPOLNO 16A 250V~ 1M



- SM11PW
- SM11SB
- SM11AT
- SM11ES
- SM11IW

- 16A 250V~, tip SM11
- sukladno normi EN 60669-1
- vijčano pričvršćivanje vodiča presjeka 1,5-2,5 mm²
- zamjenjiva tipka

PUSH BUTTON 1WAY 16A 250V~ 1M

- 16A 250V~, type SM11
- in accordance with EN 60669-1
- screw contacts 1.5-2.5 mm²
- replaceable button



TIPKALO JEDNOPOLNO 16A 250V~ 1M __ IN 01



- SM11PWIN01
- SM11SBIN01
- SM11ATIN01
- SM11ESIN01
- SM11IWIN01

- indikatorsko zvono IN 01
- 16A 250V~, tip SM11
- sukladno normi EN 60669-1
- vijčano pričvršćivanje vodiča presjeka 1,5-2,5 mm²
- tinjalica nije ugrađena
- zamjenjiva tipka

PUSH BUTTON 1WAY 16A 250V~ 1M __ IN 01

- IN 01 indicator bell
- 16A 250V~, type SM11
- in accordance with EN 60669-1
- screw contacts 1.5-2.5 mm²
- lamp is not included
- replaceable button



S W I T C H E S S M

TIPKALO JEDNOPOLNO 16A 250V~ 1M __ IN 02



- SM11PWIN02 - svjetlosna indikacija IN 02
- SM11SBIN02 - 16A 250V~, tip SM11
- SM11ATIN02 - sukladno normi EN 60669-1
- SM11ESIN02 - vijčano pričvršćivanje vodiča presjeka 1,5-2,5 mm²
- SM11WIN02 - tinjalica nije ugrađena
- SM11IWIN02 - zamjenjiva tipka

PUSH BUTTON 1WAY 16A 250V~ 1M __ IN 02

- IN 02 indicator light
- 16A 250V~, type SM11
- in accordance with EN 60669-1
- screw contacts 1.5-2.5 mm²
- lamp is not included
- replaceable button



SKLOPKA DVOPOLNA 16AX 250V~ 1M __ NT 03



- SM20PWNT03 - NT 03 neutralna 0-1
- SM20SBNT03 - 16AX 250V~, tip SM20
- SM20ATNT03 - sukladno normi EN 60669-1
- SM20ESNT03 - vijčano pričvršćivanje vodiča presjeka 1,5-2,5 mm²
- SM20WNT03 - zamjenjiva tipka

SWITCH 2POLE 16AX 250V~ 1M __ NT 03

- NT 03 neutral 0-1
- 16AX 250V~, type SM20
- in accordance with EN 60669-1
- screw contacts 1.5-2.5 mm²
- replaceable button



SKLOPKA DVOPOLNA 16AX 250V~ 1M __ IN



- SM20PWIN - IN indikator
- SM20SBIN - 16AX 250V~, tip SM20
- SM20ATIN - sukladno normi EN 60669-1
- SM20ESIN - vijčano pričvršćivanje vodiča presjeka 1,5-2,5 mm²
- SM20IWIN - tinjalica nije ugrađena
- SM20IWIN - zamjenjiva tipka

SWITCH 2POLE 16AX 250V~ 1M __ IN

- IN indicator
- 16AX 250V~, type SM20
- in accordance with EN 60669-1
- screw contacts 1.5-2.5 mm²
- lamp is not included
- replaceable button



SKLOPKA ŽALUZIJSKA 1-0-2 16AX 250V~ 1M __ NT 10

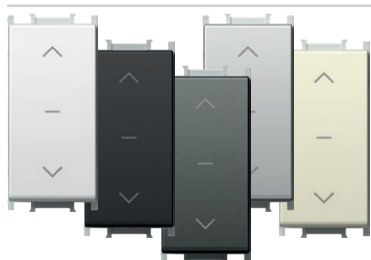

- SM40PWNT10 - NT 10 neutralna 1-0-2
- SM40SBNT10 - 16AX 250V~, tip SM40
- SM40ATNT10 - sukladno normi EN 60669-1
- SM40ESNT10 - vijčano pričvršćivanje vodiča presjeka 1,5-2,5 mm²
- SM40WNT10 - zamjenjiva tipka

SWITCH SHUTTERS 1-0-2 16AX 250V~ 1M __ NT 10

- NT 10 neutral 1-0-2
- 16AX 250V~, type SM40
- in accordance with EN 60669-1
- screw contacts 1.5-2.5mm²
- replaceable button



TIPKALO ŽALUZIJSKO 1-0-2 16A 250V~ 1M __ NT 10

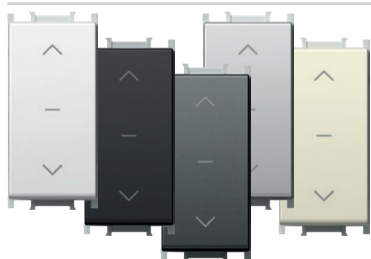

- SM41PWNT10 - NT 10 neutralna 1-0-2
- SM41SBNT10 - 16A 250V~, tip SM41
- SM41ATNT10 - sukladno normi EN 60669-1
- SM41ESNT10 - vijčano pričvršćivanje vodiča presjeka 1,5-2,5 mm²
- SM41IWIN02 - zamjenjiva tipka

PUSH BUTTON SHUTTERS 1-0-2 16A 250V~ 1M __ NT 10

- NT 10 neutral 1-0-2
- 16A 250V~, type SM41
- in accordance with EN 60669-1
- screw contacts 1.5-2.5mm²
- replaceable button



SKLOPKA IZMJENIČNA 16AX 250V~ 1M

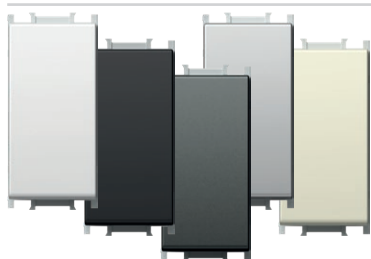

- SM60PW - 16AX 250V~, tip SM60
- SM60SB - sukladno normi EN 60669-1
- SM60AT - vijčano pričvršćivanje vodiča presjeka 1,5-2,5 mm²
- SM60ES - zamjenjiva tipka
- SM60IW

SWITCH 2WAY 16AX 250V~ 1M

- 16AX 250V~, type SM60
- in accordance with EN 60669-1
- screw contacts 1.5-2.5 mm²
- replaceable button



TIPKALO IZMJENIČNO 16A 250V~ 1M



- SM61PW
- SM61SB
- SM61AT
- SM61ES
- SM61IW

- 16A 250V~, tip SM61
- sukladno normi EN 60669-1
- vijčano pričvršćivanje vodiča presjeka 1,5-2,5 mm²
- zamjenjiva tipka

PUSH BUTTON 2WAY 16A 250V~ 1M

- 16A 250V~, type SM61
- in accordance with EN 60669-1
- screw contacts 1.5-2.5 mm²
- replaceable button



TIPKALO IZMJENIČNO S UZICOM 16A 250V~ 1M __ CD



- SM62PWCD
- SM62SBCD
- SM62ATCD
- SM62ESCD
- SM62IWCD

- CD indikator + uzica
- duljina uzice 1,5 m
- 16A 250V~, tip SM62
- sukladno normi EN 60669-1
- vijčano pričvršćivanje vodiča presjeka 1,5-2,5 mm²

PUSH BUTTON 2WAY WITH CORD 16A 250V~ 1M __ CD

- CD indikator+cord
- cord lenght 1.5m
- 16A 250V~, type SM62
- in accordance with EN 60669-1
- screw contacts 1.5-2.5 mm²



SKLOPKA KRIŽNA 16AX 250V~ 1M



- SM70PW
- SM70SB
- SM70AT
- SM70ES
- SM70IW

- 16AX 250V~, tip SM70
- sukladno normi EN 60669-1
- vijčano pričvršćivanje vodiča presjeka 1,5-2,5 mm²
- zamjenjiva tipka

SWITCH INTERMEDIATE 16AX 250V~ 1M

- 16AX 250V~, type SM70
- in accordance with EN 60669-1
- screw contacts 1.5-2.5 mm²
- replaceable button



1M = 22,5 x 45
2M = 45 x 45

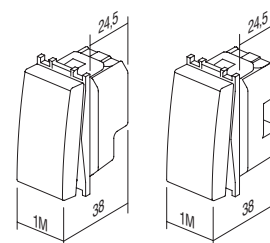

B U T T O N S T M

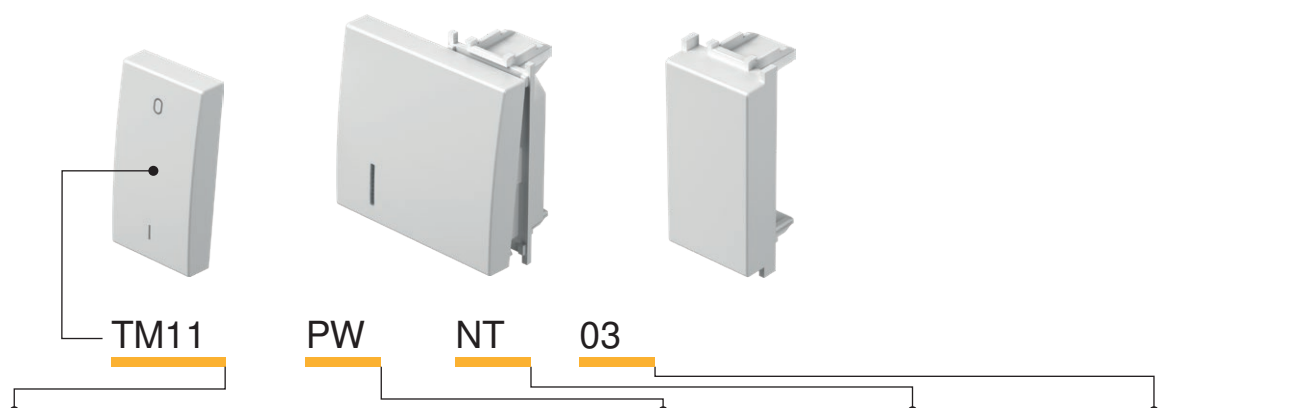

tip type	naziv description	veličina size	boja colour	opcijski podaci 1 optional data 1	opcijski podaci 2 optional data 2
TM11	TIPKA BUTTON	1M	<input type="checkbox"/> PW bijela sjajna polar white <input type="checkbox"/> SB crna mat soft touch black <input type="checkbox"/> AT antracit anthracite <input type="checkbox"/> ES srebrna mat elox silver <input type="checkbox"/> IW bež sjajna ivory white	<input type="checkbox"/> NT neutralna neutral <input type="checkbox"/> IN indikator indicator	01 02 03
TM12	TIPKA BUTTON	2M			
TM21	SLIJEPI ELEMENT BLANK	1M			
.	.	.			
.	.	.			

TIPKA 1M



- TM11PW
- TM11SB
- TM11AT
- TM11ES
- TM11IW

- zamjenjiva tipka 1M
- sukladno normi EN 60669-1

BUTTON 1M

- replaceable button 1M
- in accordance with EN 60669-1



TIPKA 1M INDIKATOR



- TM11PWIN
- TM11SBIN
- TM11ATIN
- TM11ESIN
- TM11IWIN

- zamjenjiva tipka 1M
- sukladno normi EN 60669-1

BUTTON 1M INDICATOR

- replaceable button 1M
- in accordance with EN 60669-1



TIPKA 2M

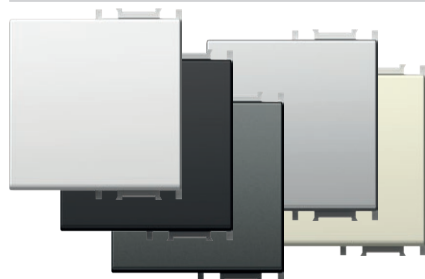

- TM12PW
- TM12SB
- TM12AT
- TM12ES
- TM12IW

- zamjenjiva tipka 2M s nosačem tipke
- za nadogradnju sklopke ili tipke
s veličine 1M na veličinu 2M.
- sukladno normi EN 60669-1

BUTTON 2M

- replaceable button 2M with button carrier
- to upgrade switch or push button
from size 1M to size 2M
- in accordance with EN 60669-1



TIPKA 2M INDIKATOR

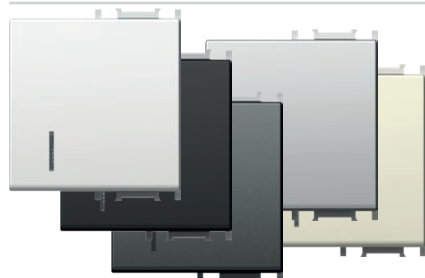

- TM12PWIN
- TM12SBIN
- TM12ATIN
- TM12ESIN
- TM12IWIN

- zamjenjiva tipka 2M s nosačem tipke
- za nadogradnju sklopke ili tipke
s veličine 1M na veličinu 2M.
- sukladno normi EN 60669-1

BUTTON 2M INDICATOR

- replaceable button 2M with button carrier
- to upgrade switch or push button
from size 1M to size 2M
- in accordance with EN 60669-1



TIPKA 2M S NATPISNOM PLOČICOM

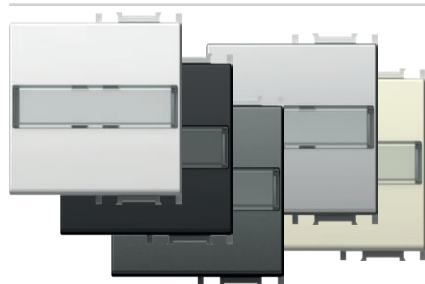

- TM13PWIL
- TM13SBIL
- TM13ATIL
- TM13ESIL
- TM13IWIL

- zamjenjiva tipka 2M s nosačem tipke
 - upotrebljava se pri nadogradnji sklopke ili tipkala od veličine 1M na veličinu 2M
 - sukladno normi EN 60669-1

BUTTON 2M WITH INSCRIPTION PLATE
 - replaceable button 2M with button carrier
 - to upgrade switch or push button from size 1M to size 2M
 - in accordance with EN 60669-1



TIPKA 1M DVOPOLNA

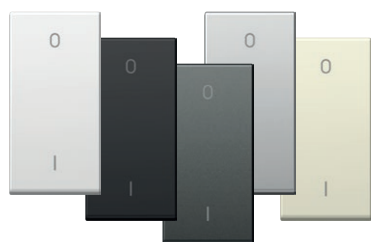

- TM15PW
- TM15SB
- TM15AT
- TM15ES
- TM15IW

- zamjenjiva tipka 1M
 - samo u kombinaciji s mehanizmom SM20
 - sukladno normi EN 60669-1

BUTTON 1M 2POLE
 - replaceable button 1M
 - only in combination with mechanism SM20
 - in accordance with EN 60669-1



SLIJEPI ELEMENT 1M

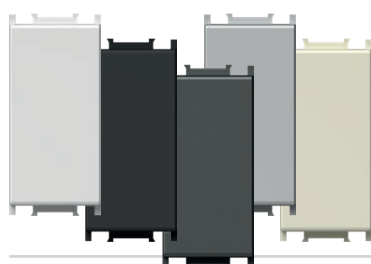

- TM21PW
- TM21SB
- TM21AT
- TM21ES
- TM21IW

- slijepi element za popunjavanje praznog mjesta
 - sukladno normi EN 60669-1

BLANK 1M
 - blank modul to fill up empty spaces
 - in accordance with EN 60669-1



SLIJEPI ELEMENT 2M

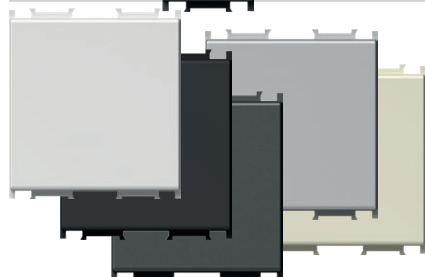

- TM22PW
- TM22SB
- TM22AT
- TM22ES
- TM22IW

- slijepi element za popunjavanje praznog mjesta
 - sukladno normi EN 60669-1

BLANK 2M
 - blank modul to fill up empty spaces
 - in accordance with EN 60669-1



UVODNICA 1M

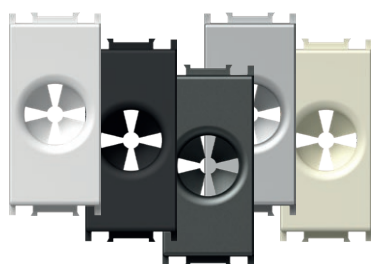

- TM31PW
- TM31SB
- TM31AT
- TM31ES
- TM31IW

- uvodnica za kabel
 - sukladno normi EN-60669-1

CABLE OUTLET 1M
 - outlet for cable
 - in accordance with EN-60669-1



1M = 22,5 x 45
 2M = 45 x 45

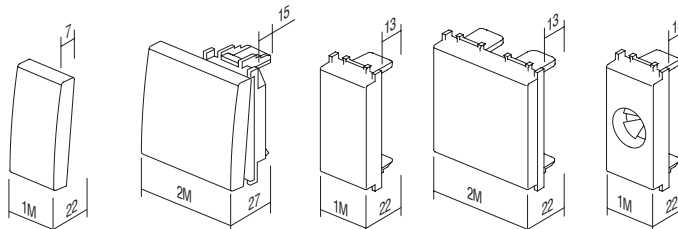

TM11
 TM15

TM12
 TM13

TM21

TM22

TM31

B U T T O N S T M

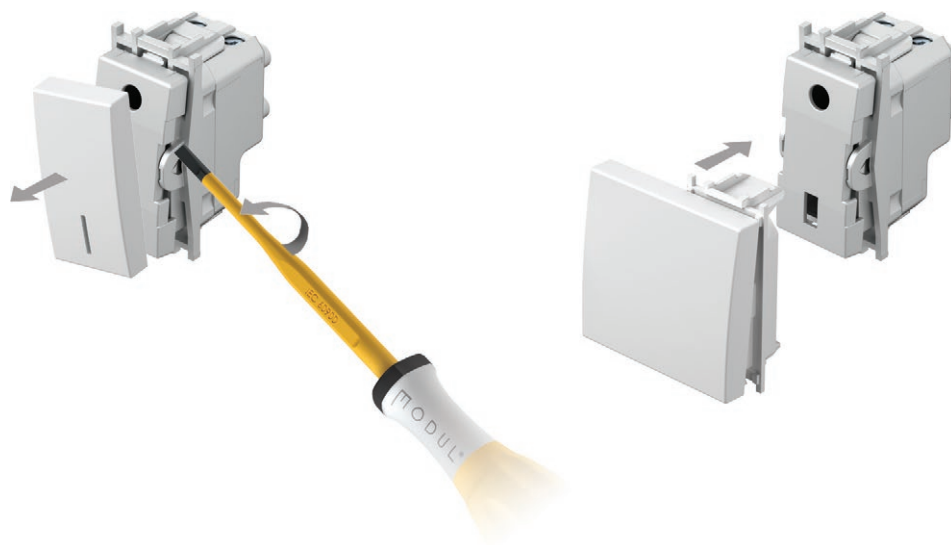

LASERSKO GRAVIRANJE NA TIPKAMA

- lasersko graviranje proizvodnje grafike na označenome mjestu
- standardni simboli dostupni sa skladišta, ostali na zahtjev

LASER PRINT ON BUTTONS

- laser print of any graphics on marked locations
- standard symbols from stock, other on request

1M

A
B
C

2M

A	D	G
B	E	H
C	F	I

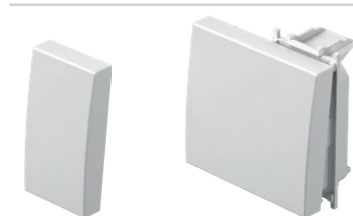

SIMBOLI

SYMBOLS

01	02	03	04	05	06	07	08	09	10	11	12	20	21	22	23
24	25	26	27	28	29	30	31	32	33	34	35	36	37	38	39
					OFF	ON					AC				
40	41	42	43	44	45	46	47	48							

STANDARDNI SIMBOLI

STANDARD SYMBOLS

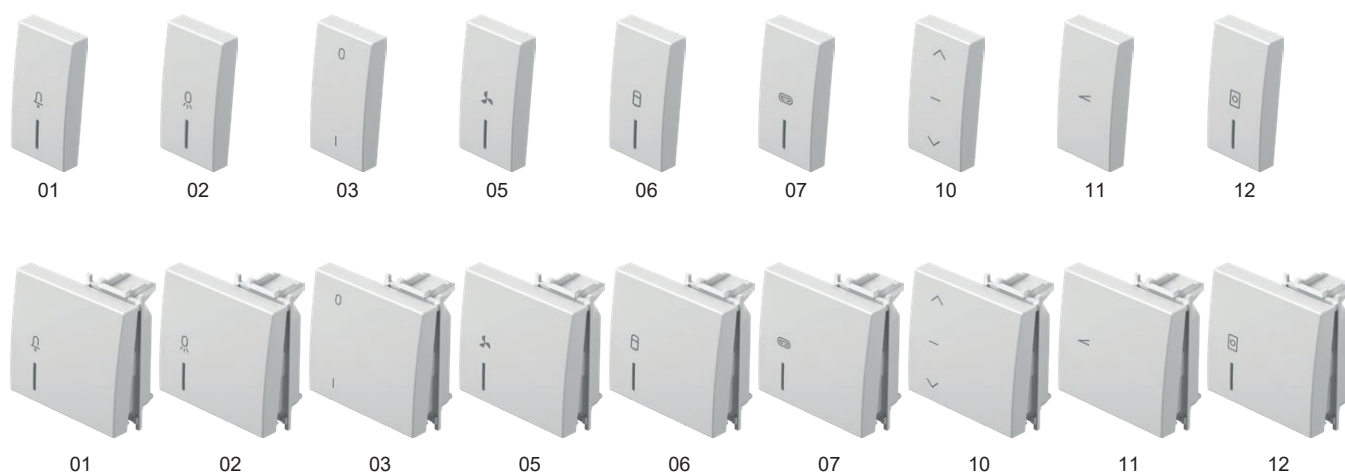

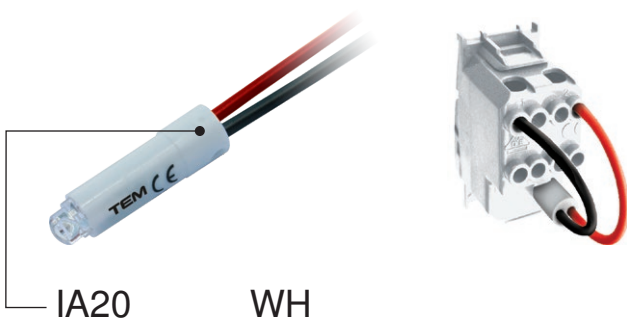

tip type	naziv description	tehnički podaci technical data	boja colour
IA10	NEONSKA TINJALICA NEON LAMP	230V~ 0,34W	<input type="checkbox"/> WH <i>bijela</i> <i>white</i>
IA20	LED TINJALICA LED LAMP	230V~ AC/DC 0,40W	<input checked="" type="checkbox"/> BL <i>plava</i> <i>blue</i>
IA21	LED TINJALICA LED LAMP	24V AC/DC 0,20W	<input checked="" type="checkbox"/> RD <i>crvena</i> <i>red</i>
·	·	·	<input checked="" type="checkbox"/> GR <i>zelena</i> <i>green</i>
·	·	·	<input checked="" type="checkbox"/> OR <i>narančasta</i> <i>orange</i>

NEONSKA TINJALICA 230V~ 0,34W

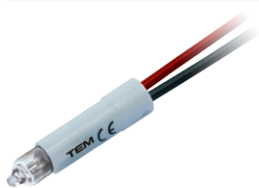

IA10OR

- za indicaciju, osvjtljenje ili stalno osvjtljenje sklopke
- u kombinaciji s tipkom s indikatorom

NEON LAMP 230V~ 0,34W

- for indication, illumination or constant illumination of switch
- in combination with button with indicator

LED TINJALICA 230V AC/DC 0,40W



- IA20WH
- IA20GR
- IA20RD
- IA20BL

- za indicaciju, osvjtljenje ili stalno osvjtljenje sklopke
- u kombinaciji s tipkom s indikatorom

LED LAMP 230V AC/DC 0,40W

- for indication, illumination or constant illumination of switch
- in combination with button with indicator

LED TINJALICA 24V AC/DC 0,20W



- IA21WH
- IA21RD

- za indicaciju, osvjtljenje ili stalno osvjtljenje sklopke
- u kombinaciji s tipkom s indikatorom

LED LAMP 24V AC/DC 0,20W

- for indication, illumination or constant illumination of switch
- in combination with button with indicator

LED TINJALICA 12V AC/DC 0,10W



- IA22WH
- IA22RD

- za indicaciju, osvjtljenje ili stalno osvjtljenje sklopke
- u kombinaciji s tipkom s indikatorom

LED LAMP 12V AC/DC 0,10W

- for indication, illumination or constant illumination of switch
- in combination with button with indicator

RC SKLOP 250V~

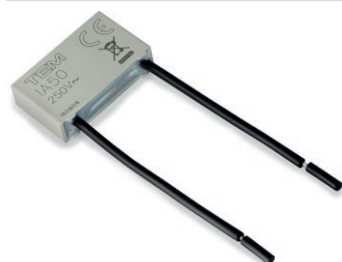

IA50

- RC sklop za uklanjanje smetnji pri radu LED svjetiljki
- moguće je usporedno povezati više RC sklopova sa svjetiljkama
- 0,1 µF, 100 Ω, 250V~

RC CIRCUIT 250V~

- RC circuit to eliminate disturbances in the operation of LED lamps
- parallel connections of more RC circuits with lamps are possible
- 0,1 µF, 100 Ω, 250V~

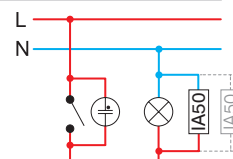

Indikacija /
Indication

* Rasvjetna tijela /
Illumination

Stalno osvjetljenje /
Constant illumination

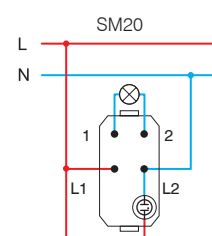
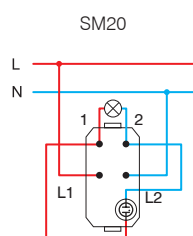
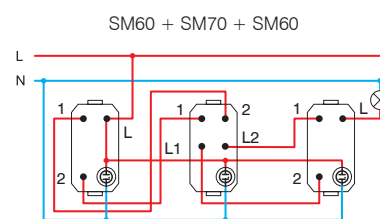
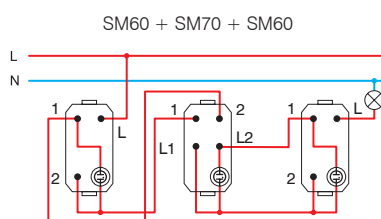
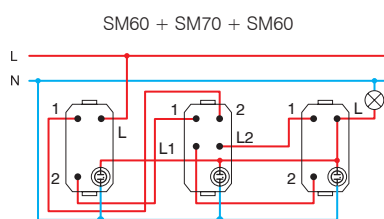
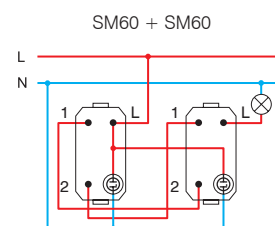
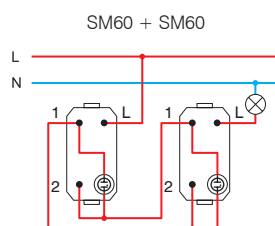
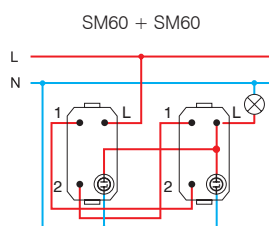
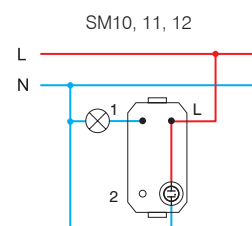
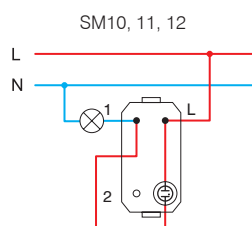
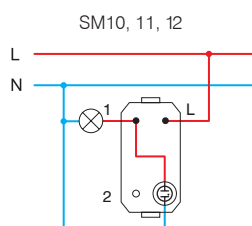

* spajanje nije prikladno za štedljive (CFL, LED) tinjalice /
the connections are not suitable for energy-saving bulbs (CFL, LED)

1M = 22,5 x 45
2M = 45 x 45

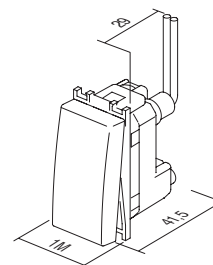

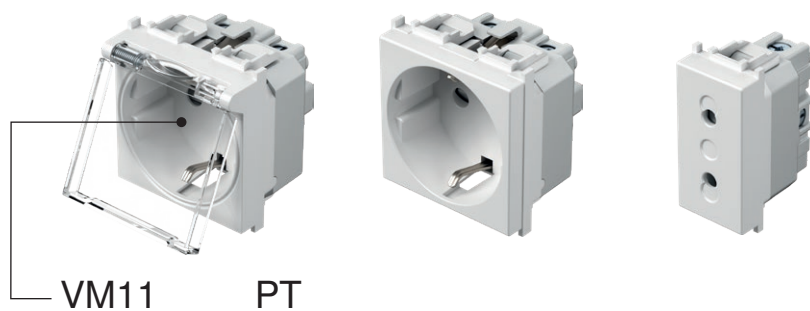

VM11

PT

tip type	naziv description	tehnički podaci technical data	veličina size	boja colour																		
VM10	UTIČNICA ŠUKO+KS SOCKET SCHUKO+KS	2P+E 16A 250V~	2M	<table border="0"> <tr> <td><input type="checkbox"/> PW bijela sjajna polar white</td> <td><input checked="" type="checkbox"/> PT bijela+prozirna white+transparent</td> <td><input type="checkbox"/> PP bijela+bijela white+white</td> </tr> </table>	<input type="checkbox"/> PW bijela sjajna polar white	<input checked="" type="checkbox"/> PT bijela+prozirna white+transparent	<input type="checkbox"/> PP bijela+bijela white+white															
<input type="checkbox"/> PW bijela sjajna polar white	<input checked="" type="checkbox"/> PT bijela+prozirna white+transparent	<input type="checkbox"/> PP bijela+bijela white+white																				
VM11	UTIČNICA ŠUKO+KS+POKLOPAC SOCKET SCHUKO+KS+COVER	2P+E 16A 250V~	2M	<table border="0"> <tr> <td><input checked="" type="checkbox"/> SB crna mat soft touch black</td> <td><input checked="" type="checkbox"/> BT crna+prozirna soft touch black+transparent</td> <td><input checked="" type="checkbox"/> BB crna+crna soft touch black+black</td> </tr> </table>	<input checked="" type="checkbox"/> SB crna mat soft touch black	<input checked="" type="checkbox"/> BT crna+prozirna soft touch black+transparent	<input checked="" type="checkbox"/> BB crna+crna soft touch black+black															
<input checked="" type="checkbox"/> SB crna mat soft touch black	<input checked="" type="checkbox"/> BT crna+prozirna soft touch black+transparent	<input checked="" type="checkbox"/> BB crna+crna soft touch black+black																				
VM20	UTIČNICA EURO+KS SOCKET EURO+KS	2P 10A 250V~	1M	<table border="0"> <tr> <td><input checked="" type="checkbox"/> AT antracit anthracite</td> <td><input checked="" type="checkbox"/> AT antracit+prozirna anthracite+transparent</td> <td><input checked="" type="checkbox"/> AA antracit+antracit anthracite+anthracite</td> </tr> <tr> <td><input type="checkbox"/> ES srebrna mat elox silver</td> <td><input checked="" type="checkbox"/> ST srebrna+prozirna silver+transparent</td> <td><input type="checkbox"/> SS srebrna+srebrna silver+silver</td> </tr> <tr> <td><input type="checkbox"/> IW bež sjajna ivory white</td> <td><input checked="" type="checkbox"/> IT bež+prozirna ivory+transparent</td> <td><input type="checkbox"/> II bež+bež ivory+ivory</td> </tr> <tr> <td><input checked="" type="checkbox"/> RD crvena red</td> <td><input checked="" type="checkbox"/> RT crvena+prozirna red+transparent</td> <td><input checked="" type="checkbox"/> RR crvena+crvena red+red</td> </tr> <tr> <td><input checked="" type="checkbox"/> GR zelena green</td> <td><input checked="" type="checkbox"/> GT zelena+prozirna green+transparent</td> <td><input checked="" type="checkbox"/> GG zelena+zelena green+green</td> </tr> <tr> <td><input checked="" type="checkbox"/> OR narančasta orange</td> <td><input checked="" type="checkbox"/> OT narančasta+prozirna orange+transparent</td> <td><input checked="" type="checkbox"/> OO narančasta+narančasta orange+orange</td> </tr> </table>	<input checked="" type="checkbox"/> AT antracit anthracite	<input checked="" type="checkbox"/> AT antracit+prozirna anthracite+transparent	<input checked="" type="checkbox"/> AA antracit+antracit anthracite+anthracite	<input type="checkbox"/> ES srebrna mat elox silver	<input checked="" type="checkbox"/> ST srebrna+prozirna silver+transparent	<input type="checkbox"/> SS srebrna+srebrna silver+silver	<input type="checkbox"/> IW bež sjajna ivory white	<input checked="" type="checkbox"/> IT bež+prozirna ivory+transparent	<input type="checkbox"/> II bež+bež ivory+ivory	<input checked="" type="checkbox"/> RD crvena red	<input checked="" type="checkbox"/> RT crvena+prozirna red+transparent	<input checked="" type="checkbox"/> RR crvena+crvena red+red	<input checked="" type="checkbox"/> GR zelena green	<input checked="" type="checkbox"/> GT zelena+prozirna green+transparent	<input checked="" type="checkbox"/> GG zelena+zelena green+green	<input checked="" type="checkbox"/> OR narančasta orange	<input checked="" type="checkbox"/> OT narančasta+prozirna orange+transparent	<input checked="" type="checkbox"/> OO narančasta+narančasta orange+orange
<input checked="" type="checkbox"/> AT antracit anthracite	<input checked="" type="checkbox"/> AT antracit+prozirna anthracite+transparent	<input checked="" type="checkbox"/> AA antracit+antracit anthracite+anthracite																				
<input type="checkbox"/> ES srebrna mat elox silver	<input checked="" type="checkbox"/> ST srebrna+prozirna silver+transparent	<input type="checkbox"/> SS srebrna+srebrna silver+silver																				
<input type="checkbox"/> IW bež sjajna ivory white	<input checked="" type="checkbox"/> IT bež+prozirna ivory+transparent	<input type="checkbox"/> II bež+bež ivory+ivory																				
<input checked="" type="checkbox"/> RD crvena red	<input checked="" type="checkbox"/> RT crvena+prozirna red+transparent	<input checked="" type="checkbox"/> RR crvena+crvena red+red																				
<input checked="" type="checkbox"/> GR zelena green	<input checked="" type="checkbox"/> GT zelena+prozirna green+transparent	<input checked="" type="checkbox"/> GG zelena+zelena green+green																				
<input checked="" type="checkbox"/> OR narančasta orange	<input checked="" type="checkbox"/> OT narančasta+prozirna orange+transparent	<input checked="" type="checkbox"/> OO narančasta+narančasta orange+orange																				



UTIČNICA ŠUKO+KS 2P+E 16A 250V~ 2M

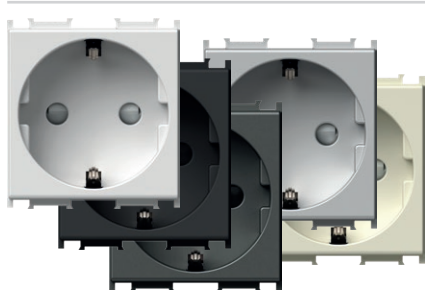

- VM10PW
- VM10SB
- VM10AT
- VM10ES
- VM10IW

- 2P+E šuko
- 16A 250V~, tip VM10
- sukladno normama IEC 60884-1, CEE7
- vijčano pričvršćivanje vodiča presjeka 1,5-2,5 mm²
- utičnica s integriranom zaštitom



SOCKET SCHUKO+KS 2P+E 16A 250V~ 2M

- 2P+E schuko
- 16A 250V~, type VM10
- in accordance with IEC 60884-1, CEE7
- screw contacts 1.5-2.5 mm²
- shuttered live contacts

UTIČNICA ŠUKO+KS 2P+E 16A 250V~ 2M

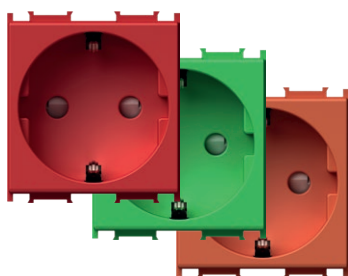

- VM10RD
- VM10GR
- VM10OR

- 2P+E šuko
- 16A 250V~, tip VM10
- sukladno normama IEC 60884-1, CEE7
- vijčano pričvršćivanje vodiča presjeka 1,5-2,5 mm²
- utičnica s integriranom zaštitom



SOCKET SCHUKO+KS 2P+E 16A 250V~ 2M

- 2P+E schuko
- 16A 250V~, type VM10
- in accordance with IEC 60884-1, CEE7
- screw contacts 1.5-2.5 mm²
- shuttered live contacts

UTIČNICA ŠUKO+KS +POKLOPAC 2P+E 16A 250V~ 2M

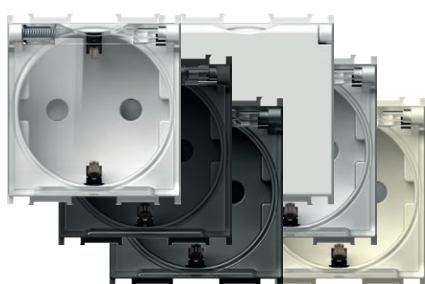

- VM11PT
- VM11BT
- VM11AT
- VM11ST
- VM11IT
- VM11PP

- 2P+E šuko + poklopac
- 16A 250V~, tip VM11
- sukladno normama IEC 60884-1, CEE7
- vijčano pričvršćivanje vodiča presjeka 1,5-2,5 mm²
- utičnica s integriranom zaštitom

SOCKET SCHUKO+KS+COVER

- 2P+E 16A 250V~ 2M
- 2P+E schuko+cover
- 16A 250V~, type VM11
- in accordance with IEC 60884-1, CEE7
- screw contacts 1.5-2.5 mm²
- shuttered live contacts



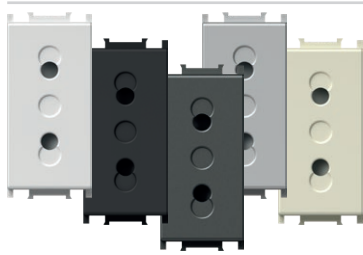

- VM20PW
- VM20SB
- VM20AT
- VM20ES
- VM20IW

UTIČNICA EURO+KS 2P 10A 250V~ 1M

- 2P Euro
- 10A 250V~, tip VM20
- sukladno normama IEC 60884-1, CEE7
- vijčano pričvršćivanje vodiča presjeka 1,5-2,5 mm²
- utičnica s integriranom zaštitom



SOCKET EURO+KS 2P 10A 250V~ 1M

- 2P Euro
- 10A 250V~, type VM20
- in accordance with IEC 60884-1, CEE7
- screw contacts 1.5-2.5 mm²
- shuttered live contacts

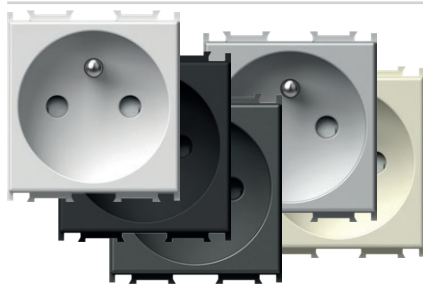

- VM40PW
- VM40SB
- VM40AT
- VM40ES
- VM40IW

UTIČNICA FRANCUSKA+KS 2P+E 16A 250V~ 2M

- 2P+E francuska
- 16A 250V~, tip VM40
- sukladno normama IEC 60884-1, NF C 61-314 CEE7
- vijčano pričvršćivanje vodiča presjeka 1,5-2,5 mm²
- utičnica s integriranom zaštitom



SOCKET FRENCH+KS 2P+E 16A 250V~ 2M

- 2P+E French
- 16A 250V~, type VM40
- in accordance with IEC 60884-1, NF C 61-314, CEE7
- screw contacts 1.5-2.5 mm²
- shuttered live contacts

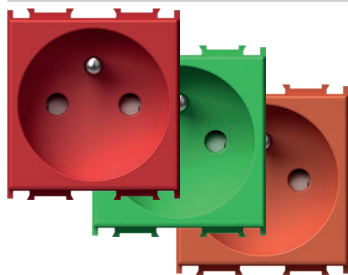

- VM40RD
- VM40GR
- VM40OR

UTIČNICA FRANCUSKA+KS 2P+E 16A 250V~ 2M

- 2P+E francuska
- 16A 250V~, tip VM40
- sukladno normama IEC 60884-1, NF C 61-314 CEE7
- vijčano pričvršćivanje vodiča presjeka 1,5-2,5 mm²
- utičnica s integriranom zaštitom



SOCKET FRENCH+KS 2P+E 16A 250V~ 2M

- 2P+E French
- 16A 250V~, type VM40
- in accordance with IEC 60884-1, NF C 61-314, CEE7
- screw contacts 1.5-2.5 mm²
- shuttered live contacts



- VM41PT
- VM41BT
- VM41AT
- VM41PP
- VM41ST
- VM41IT

UTIČNICA FRANCUSKA+KS+POKLOPAC 2P+E 16A 250V~ 2M

- 2P+E francuska+poklopac
- 16A 250V~, tip VM41
- sukladno normama IEC 60884-1, NF C 61-314 CEE7
- vijčano pričvršćivanje vodiča presjeka 1,5-2,5 mm²
- utičnica s integriranom zaštitom



SOCKET FRENCH+KS+COVER

- 2P+E 16A 250V~ 2M
- 2P+E French+cover
- 16A 250V~, type VM41
- in accordance with IEC 60884-1, NF C 61-314, CEE7
- screw contacts 1.5-2.5 mm²
- shuttered live contacts

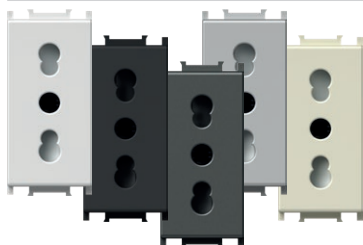

- VM30PW
- VM30SB
- VM30AT
- VM30ES
- VM30IW

UTIČNICA TALIJANSKA P17/11+KS 2P+E 16A 250V~ 1M

- 2P+E talijanska P17/11
- 16A 250V~, tip VM30
- sukladno normama IEC 60884-1, CEI 23-50
- vijčano pričvršćivanje vodiča presjeka 1,5-2,5 mm²
- utičnica s integriranom zaštitom



SOCKET ITALIAN P17/11+KS 2P+E 16A 250V~ 1M

- 2P+E Italian P17/11
- 16A 250V~, type VM30
- in accordance with IEC 60884-1, CEI 23-50
- screw contacts 1.5-2.5 mm²
- shuttered live contacts

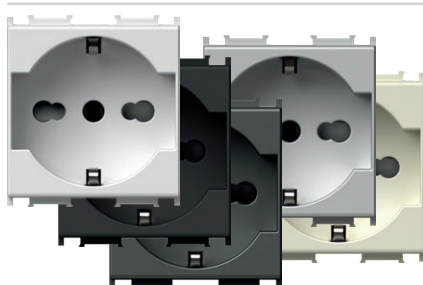

- VM31PW
- VM31SB
- VM31AT
- VM31ES
- VM31IW

UTIČNICA ŠUKO TALIJANSKA P17/11+KS 2P+E 16A 250V~ 2M

- 2P+E šuko/talijanska P17/11
- 16A 250V~, tip VM31
- sukladno normama IEC 60884-1, CEI 23-50
- vijčano pričvršćivanje vodiča presjeka 1,5-2,5 mm²
- utičnica s integriranom zaštitom

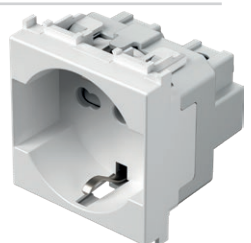

SOCKET SCHUKO/ITA P17/11+KS

- 2P+E 16A 250V~ 2M
- 2P+E schuko/Italian P17/11
- 16A 250V~, type VM31
- in accordance with IEC 60884-1, CEI 23-50
- screw contacts 1.5-2.5 mm²
- shuttered live contacts

UTIČNICA ŠUKO TALIJANSKA P30+KS 2P+E 16A 250V~ 2M

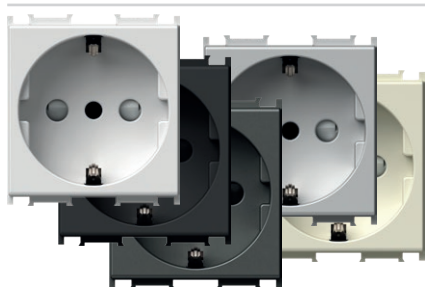

- VM32PW
- VM32SB
- VM32AT
- VM32ES
- VM32IW

- 2P+E šuko/talijanska P30
- 16A 250V~, tip VM32
- sukladno normama IEC 60884-1, CEI 23-50
- vijčano pričvršćivanje vodiča presjeka 1,5-2,5 mm²
- utičnica s integriranim zaštitom



SOCKET SCHUKO/ITA P30+KS
2P+E 16A 250V~ 2M

- 2P+E schuko/Italian P30
- 16A 250V~, type VM32
- in accordance with IEC 60884-1, CEI 23-50
- screw contacts 1.5-2.5 mm²
- shuttered live contacts

UTIČNICA TALIJANSKA P11+KS 2P+E 10A 250V~ 1M

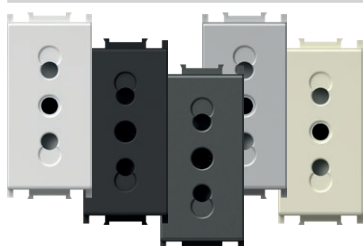

- VM33PW
- VM33SB
- VM33AT
- VM33ES
- VM33IW

- 2P+E talijanska P11
- 10A 250V~, tip VM33
- sukladno normama IEC 60884-1, CEI 23-50
- vijčano pričvršćivanje vodiča presjeka 1,5-2,5 mm²
- utičnica s integriranom zaštitom



SOCKET ITALIAN P11+KS 2P+E 10A 250V~ 1M

- 2P+E Italian P11
- 10A 250V~, type VM33
- in accordance with IEC 60884-1, CEI 23-50
- screw contacts 1.5-2.5 mm²
- shuttered live contacts

UTIČNICA EURO/AMERIČKA+KS 2P 16A 250V~ 1M

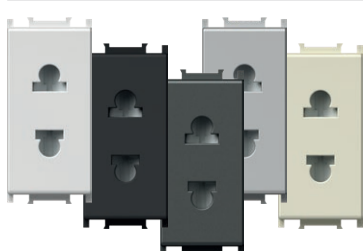

- VM21PW
- VM21SB
- VM21AT
- VM21ES
- VM21IW

- 2P euro/američka
- 16A 250V~, tip VM21
- vijčano pričvršćivanje vodiča presjeka 1,5-2,5 mm²
- utičnica s integriranim zaštitom
- samo za zemlje koje nisu članice EU-a



SOCKET EURO/AMERICAN+KS 2P 16A 250V~ 1M

- 2P Euro/American
- 16A 250V~, type VM21
- screw contacts 1.5-2.5 mm²
- shuttered live contacts
- only for countries not members of EU

UTIČNICA BRITANSKA BS 1363-2+KS 2P+E 13A 250V~ 2M

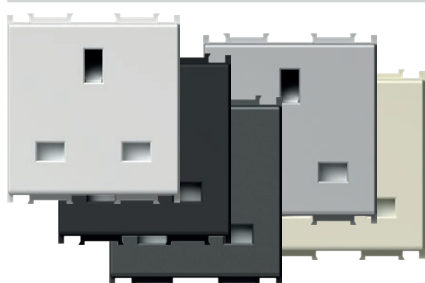

- VM52PW
- VM52SB
- VM52AT
- VM52ES
- VM52IW

- 2P+E britanska BS 1363-2
- 13A 250V~, tip VM52
- sukladno normi BS 1363-2
- vijčano pričvršćivanje vodiča presjeka 1,5-4 mm²
- utičnica s integriranom zaštitom



SOCKET BRITISH BS 1363-2+KS 2P+E 13A 250V~ 2M

- 2P+E British BS 1363-2
- 13A 250V~, type VM52
- in accordance with BS 1363-2
- screw contacts 1.5-4 mm²
- shuttered live contacts

UTIČNICA MULTISTANDARDNA+KS 2P+E 13A 250V~ 2M

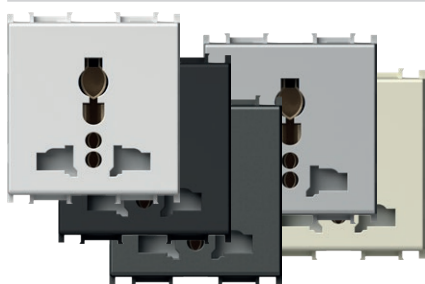

- VM55PW
- VM55SB
- VM55AT
- VM55ES
- VM55IW

- bezvijčano pričvršćivanje vodiča 1,5 – 2,5 mm²
- ugrađena zaštita od dodira kontakta

SOCKET MULTI-STANDARD+KS 2P+E 13A 250V~ 2M

- plug-in contacts 1.5-2.5 mm²
- built-in contact protection



PRENAPONSKA ZAŠTITA MPE MINI 275V/50Hz



VM80

- paralelni spoj s prvom utičnicom u nizu
- razred zaštite III
- U_c = 275Vac, U_{oc}/I_{sc} = 6kV/3kA, U_p < 800V
- sukladno normi IEC 61643-1
- vodiči presjeka 1,5 mm², IP20
- zvučni signal u slučaju proboja





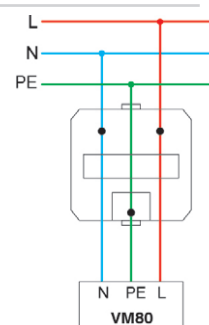









SURGE PROTECTOR MPE MINI 275V/50Hz

- parallel connection with the first socket in the row
- protection class III
- U_c = 275Vac, U_{oc}/I_{sc} = 6kV/3kA, U_p < 800V
- in accordance with IEC 61643-1
- wires 1.5mm², IP20
- sound signal at breakdown







S O C K E T S V M

POVEZIVANJE UTIČNICA I UTIKAČA
SOCKETS AND PLUGS MATCHING

UTIČNICA / SOCKET									
VRSTA UTIKAČA / PLUG STYLE	VM10 VM11	VM20	VM30	VM33	VM31	VM32	VM40 VM41	VM21	VM55
Njemački / German 	•				•	•			•
Francuski / French 	•				•	•	•		•
Talijanski / Italian S11 			•	•	•	•			•
Talijanski / Italian S17 			•		•				•
euro 	•	•	•		•	•	•	•	•

POVEZIVANJE UTIČNICA I UTIKAČA
SOCKETS AND PLUGS MATCHING

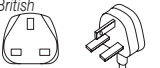
UTIČNICA / SOCKET			
VRSTA UTIKAČA / PLUG STYLE	VM21	VM52	VM55
Američki / American 	•		•
Britanski / British BS 1363-2 		•	•

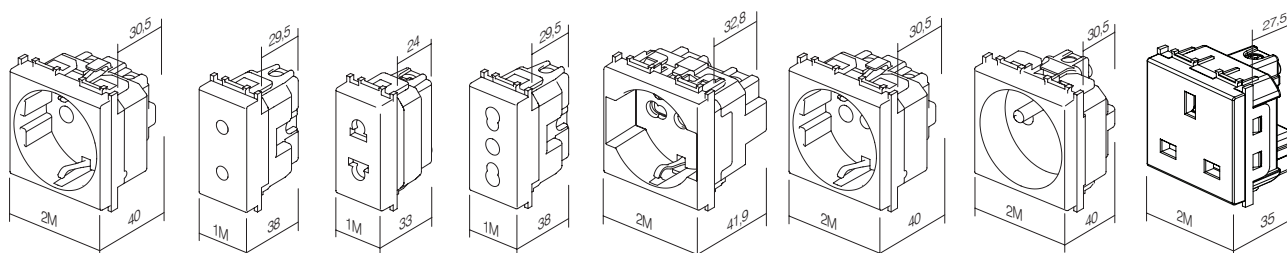
VM10
VM11

VM20

VM21

VM30
VM33

VM31

VM32

VM40
VM41

VM52

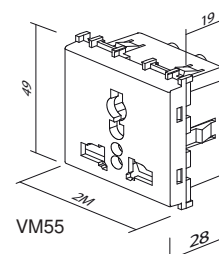
1M = 22,5 x 45
2M = 45 x 45

VM55



KM10

PW

tip type	naziv description	tehnički podaci technical data	veličina size	boja colour
KM10	UTIČNICA TV OSNOVNA SOCKET TV BASIC	0dB	1M	<input type="checkbox"/> PW bijela sjajna polar white
KM11	UTIČNICA TV ZAVRŠNA SOCKET TV END-LINE	1dB	1M	<input checked="" type="checkbox"/> SB crna mat soft touch black
KM12	UTIČNICA TV PROLAZNA SOCKET TV TROUGHPASS	10dB	1M	<input checked="" type="checkbox"/> AT antracit anthracite
⋮	⋮	⋮	⋮	<input type="checkbox"/> ES srebrna mat elox silver
⋮	⋮	⋮	⋮	<input type="checkbox"/> IW bež sjajna ivory white

UTIČNICA TV OSNOVNA 0dB 1M

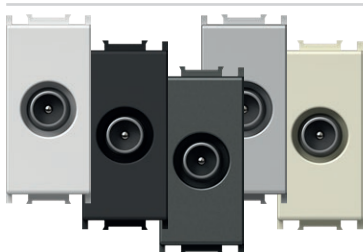

- KM10PW
- KM10SB
- KM10AT
- KM10ES
- KM10IW

- TV osnovna
 - prigušenje 0dB
 - stražnji konektor – F standard
- SOCKET TV BASIC 0dB 1M*
- TV basic
 - reduction 0dB
 - back connector – F standard



UTIČNICA TV OSNOVNA 0dB 2M

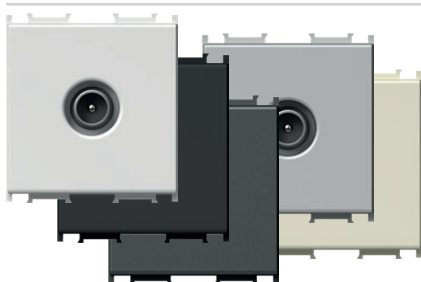

- KM20PW
- KM20SB
- KM20AT
- KM20ES
- KM20IW

- TV osnovna
 - prigušenje 0dB
 - stražnji konektor – F standard
- SOCKET TV BASIC 0dB 2M*
- TV basic
 - reduction 0dB
 - back connector – F standard



UTIČNICA TV ZAVRŠNA 1dB 1M



- KM11PW
- KM11SB
- KM11AT
- KM11ES
- KM11IW

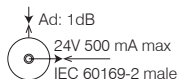

- TV završna
 - propušta frekvenciju u rasponu 5÷2400 MHz
 - prigušenje < 1 dB
 - sukladno normi EN 50083-1
 - vijčano pričvršćivanje vodiča
- SOCKET TV END-LINE 1dB 1M*
- TV end-line
 - frequency range 5÷2400 MHz
 - reduction < 1 dB
 - in accordance with EN 50083-1
 - screw contacts



UTIČNICA TV PROLAZNA 10dB 1M



- KM12PW
- KM12SB
- KM12AT
- KM12ES
- KM12IW

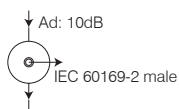

- TV prolazna
 - propušta frekvenciju u rasponu 5÷2400 MHz
 - prigušenje < 10 dB
 - sukladno normi EN 50083-1
 - vijčano pričvršćivanje vodiča
- SOCKET TV TROUGHPASS 10dB 1M*
- TV troughpass
 - frequency range 5÷2400 MHz
 - reduction < 10 dB
 - in accordance with EN 50083-1
 - screw contacts



UTIČNICA SAT OSNOVNA 0dB 1M



- KM15PW
- KM15SB
- KM15AT
- KM15ES
- KM15IW

- SAT osnovna
 - prigušenje 0dB
 - stražnji konektor – F standard
- SOCKET SAT BASIC 0dB 1M*
- SAT basic
 - reduction 0dB
 - back connector – F standard



UTIČNICA SAT OSNOVNA 0dB 2M

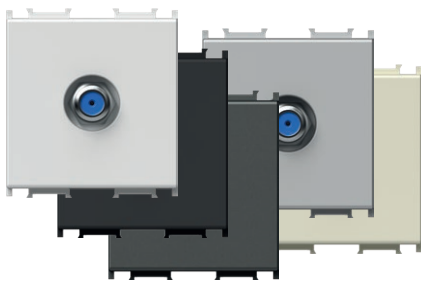

- KM24PW
- KM24SB
- KM24AT
- KM24ES
- KM24IW

- SAT osnovna
 - prigušenje 0dB
 - stražnji konektor – F standard
- SOCKET SAT BASIC 0dB 2M*
- SAT basic
 - reduction 0dB
 - back connector – F standard



UTIČNICA SAT ZAVRŠNA 1dB 1M



- KM16PW
- KM16SB
- KM16AT
- KM16ES
- KM16IW

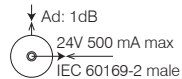

- SAT završna
 - propušta frekvenciju u rasponu 5÷2400 MHz
 - prigušenje < 1dB
 - sukladno normi EN 50083-1
 - vijčano pričvršćivanje vodiča
- SOCKET SAT END-LINE 1dB 1M*
- SAT end-line
 - frequency range 5÷2400 MHz
 - reduction < 1dB
 - in accordance with EN 50083-1
 - screw contacts



UTIČNICA R OSNOVNA 0dB 1M



- KM19PW
- KM19SB
- KM19AT
- KM19ES
- KM19IW

- R OSNOVNA
 - prigušenje 0dB
 - stražnji konektor – F standard
- SOCKET R BASIC 0dB 1M*
- R basic
 - reduction 0dB
 - back connector – F standard



UTIČNICA R OSNOVNA 0dB 2M

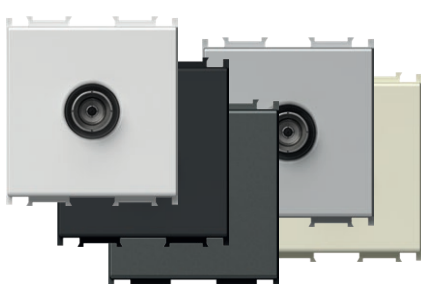

- KM29PW
- KM29SB
- KM29AT
- KM29ES
- KM29IW

- R osnovna
 - prigušenje 0dB
 - stražnji konektor – F standard
- SOCKET R BASIC 0dB 2M*
- R basic
 - reduction 0dB
 - back connector – F standard



UTIČNICA SAT-TV ZAVRŠNA 1dB 2M

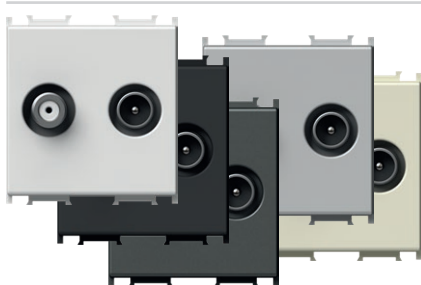

- KM25PW
- KM25SB
- KM25AT
- KM25ES
- KM25IW

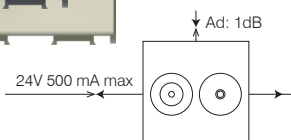

- SAT-TV završna
 - propušta frekvenciju u rasponu 5÷2400 MHz
 - prigušenje < 1dB
 - sukladno normi EN 50083-1
 - vijčano pričvršćivanje vodiča
- SOCKET SAT-TV END-LINE 1dB 2M*
- SAT-TV end-line
 - frequency range 5÷2400 MHz
 - reduction < 1dB
 - in accordance with EN 50083-1
 - screw contacts



PRIMJERI OSNOVNOG SPOJA
BASIC CONNECTION SAMPLES

pojedinačni spoj
stand alone connection



KM10
KM20
KM11
KM15
KM24
KM16
KM19
KM29
KM25

zvjezdasti spoj
star connection

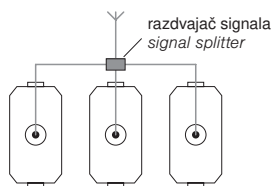

KM10
KM20
KM11
KM15
KM24
KM16
KM19
KM29
KM25

prolazni spoj
throughpass connection

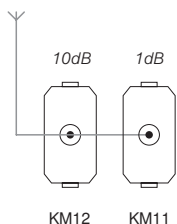

UTIČNICA AUDIO 2xRCA 1M



- KM22PW
- KM22SB
- KM22AT
- KM22ES
- KM22IW

- audio 2x RCA
- lemljenje spojeva kabela na stražnjoj strani

SOCKET AUDIO 2xRCA 1M

- audio 2x RCA
- soldering connection of cable at the back side



UTIČNICA AUDIO ZVUČNICI 1M



- KM23PW
- KM23SB
- KM23AT
- KM23ES
- KM23IW

- audio 2x Ø4 mm
- pričvršćivanje vodiča za zvučnike umetanjem ili banana utikačem Ø4 mm
- lemljenje spojeva kabela na stražnjoj strani

SOCKET AUDIO LOUDSPEAKERS 1M

- audio 2x Ø4mm
- to accommodate speaker wire, banana plug Ø4mm or spades
- soldering connection of cable at the back side



UTIČNICA AUDIO ZVUČNICI 2M



- KM26PW
- KM26SB
- KM26AT
- KM26ES
- KM26IW

- audio 2x Ø4 mm
- pričvršćivanje vodiča za zvučnike umetanjem ili banana utikačeva Ø4 mm
- lemljenje spojeva kabela na stražnjoj strani

SOCKET AUDIO LOUDSPEAKERS 2M

- audio 2x Ø4mm
- to accommodate speaker wire, banana plug Ø4mm or spades
- soldering connection of cable at the back side



1M = 22,5 x 45
2M = 45 x 45

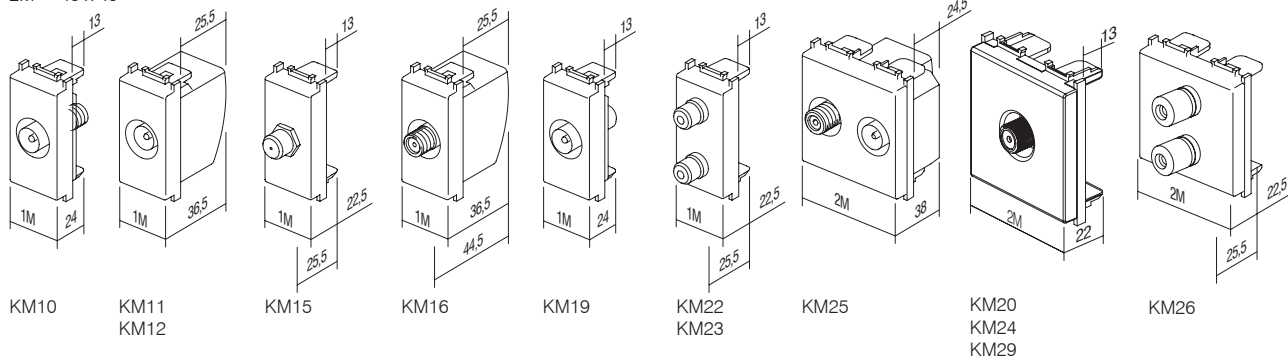

UTIČNICA TEL LT RJ11 6/4 1M



- KM30PW
- KM30SB
- KM30AT
- KM30ES
- KM30IW

- TEL LT vijak
- RJ11 6/4
- sukladno normi IEC 60603-7
- vijčano pričvršćivanje

SOCKET TEL LT RJ11 6/4 1M

- TEL LT screw
- RJ11 6/4
- in accordance with IEC 60603-7
- screw contacts



UTIČNICA TEL BT SEC 6/6 1M

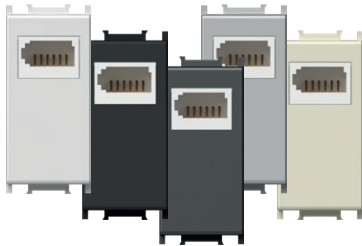

- KM31PW
- KM31SB
- KM31AT
- KM31ES
- KM31IW

- TEL BT britanski standard
- SEC sekundarna 6/6
- sukladno normi BS 6312
- vijčano pričvršćivanje

SOCKET TEL BT SEC 6/6 1M

- TEL BT British standard
- SEC secondary 6/6
- in accordance with BS 6312
- screw contacts



UTIČNICA TEL KS RJ11 6/4 1M

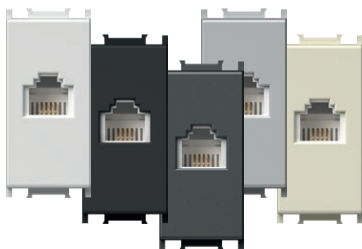

- KM36PW
- KM36SB
- KM36AT
- KM36ES
- KM36IW

- KS keystone standard pričvršćivanja
- RJ11 6/4
- sukladno normi IEC 60603-7

SOCKET TEL KS RJ11 6/4 1M

- KS keystone fixing standard
- RJ11 6/4
- in accordance with IEC 60603-7

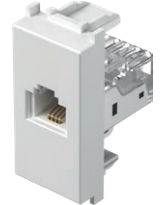

UTIČNICA CAT5e KS RJ45 8/8 1M

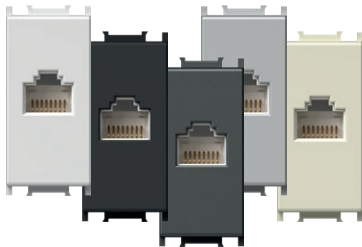

- KM37PW
- KM37SB
- KM37AT
- KM37ES
- KM37IW

- KS keystone standard pričvršćivanja
- CAT5e, RJ45 8/8
- sukladno normi IEC 60603-7

SOCKET CAT5e KS RJ45 8/8 1M

- KS keystone fixing standard
- CAT5e, RJ45 8/8
- in accordance with IEC 60603-7

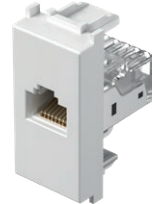

ADAPTER KS 1M

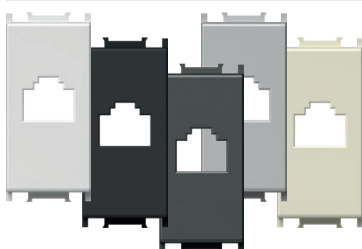

- KM35PW
- KM35SB
- KM35AT
- KM35ES
- KM35IW

- KS keystone standard pričvršćivanja
- AMP, Avaya, Brandrex, FMT, Mfico, Tyco, ...
- nije ugrađen komunikacijski modul

ADAPTER KS 1M

- KS keystone fixing standard
- AMP, Avaya, Brandrex, FMT, Mfico, Tyco, ...
- communication module not included



ADAPTER KS SA ZAŠTITOM OD PRAŠINE 1M

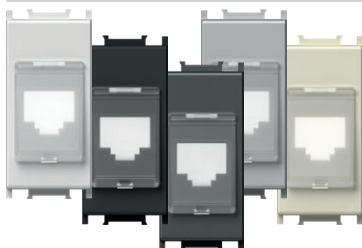

- KM38PW
- KM38SB
- KM38AT
- KM38ES
- KM38IW

- KS keystone standard pričvršćivanja sa zaštitom od prašine
- AMP, Avaya, Brandrex, FMT, Mfico, Tyco, ...
- nije ugrađen komunikacijski modul

ADAPTER KS WITH DUST PROTECTION 1M

- KS keystone fixing standard with dust protection
- AMP, Avaya, Brandrex, FMT, Mfico, Tyco, ...
- communication module not included



UTIČNICA CAT6 SCH KS RJ45 8/8 1M

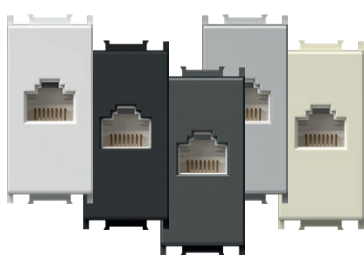

- KM39PW
- KM39SB
- KM39AT
- KM39ES
- KM39IW

- KS keystone standard pričvršćivanja
- CAT6 UTP toolless, RJ45 8/8
- odgovara ISO/IEC 11801

SOCKET CAT6 SCH KS RJ45 8/8 1M

- KS keystone fixing standard
- CAT6 UTP toolless, RJ45 8/8
- in accordance with ISO/IEC 11801



ADAPTER KS UNIVERZALNI 1M

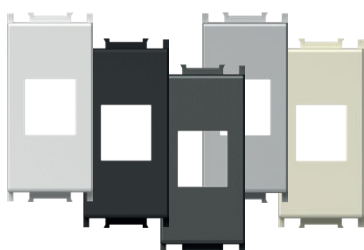

- KM50PW
- KM50SB
- KM50AT
- KM50ES
- KM50IW

- KS keystone standard pričvršćivanja
- prikladan za HDMI, USB
- nije ugrađen komunikacijski modul

ADAPTER KS UNIVERSAL 1M

- KS keystone fixing standard
- suitable for HDMI, USB
- communication module not included



ADAPTER PD 1M

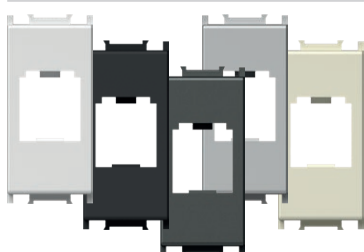

- KM40PW
- KM40SB
- KM40AT
- KM40ES
- KM40IW

- PD Panduit Mini-COM standard pričvršćivanja
- nije ugrađen komunikacijski modul

ADAPTER PD 1M

- PD Panduit Mini-COM fixing standard
- communication module not included



ADAPTER PD SA ZAŠTITOM OD PRAŠINE 1M



- KM43PW
- KM43SB
- KM43AT
- KM43ES
- KM43IW

- PD Panduit Mini-COM standard pričvršćivanja sa zaštitom od prašine
- nije ugrađen komunikacijski modul

ADAPTER PD WITH DUST PROTECTION 1M

- PD Panduit Mini-COM fixing standard with dust protection
- communication module not included



ADAPTER R&M 1M

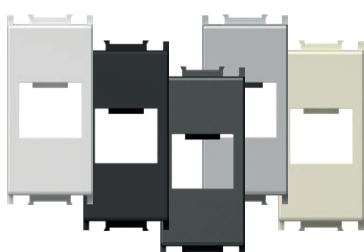

- KM46PW
- KM46SB
- KM46AT
- KM46ES
- KM46IW

- R&M standard pričvršćivanja
- nije ugrađen komunikacijski modul

ADAPTER R&M 1M

- R&M fixing standard
- communication module not included



ADAPTER R&M CAT6A 1M

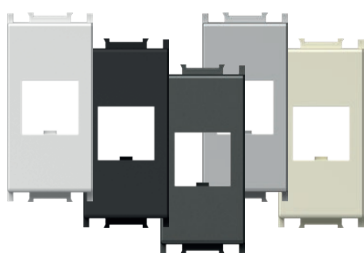

- KM52PW
- KM52SB
- KM52AT
- KM52ES
- KM52IW

- R&M montaža za CAT6A
- nije ugrađen komunikacijski modul

ADAPTER R&M CAT6A 1M

- R&M fixing for CAT6A
- communication module not included





- KM47PW
- KM47SB
- KM47AT
- KM47ES
- KM47IW

ADAPTER R&M SA ZAŠTITOM OD PRAŠINE 1M

- R&M standard pričvršćivanja sa zaštitom protiv prašine
- nije ugrađen komunikacijski modul

ADAPTER R&M WITH DUST PROTECTION 1M

- R&M fixing standard with dust protection
- communication module not included



- KM53PW
- KM53SB
- KM53AT
- KM53ES
- KM53IW

ADAPTER R&M CAT6A SA ZAŠTITOM OD PRAŠINE 1M

- R&M montaža za CAT6A s poklopcem za zaštitu od prašine
- nije ugrađen komunikacijski modul

ADAPTER R&M CAT6A WITH DUST PROTECTION 1M

- R&M fixing for CAT6A with dust protection
- communication module not included



ADAPTER LK 1M

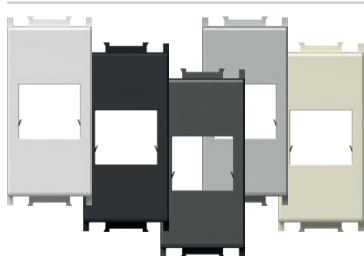

- KM45PW
- KM45SB
- KM45AT
- KM45ES
- KM45IW

- LK LeoniKerpen eLine / BKS NewLine standard pričvršćivanja
- nije uključen komunikacijski modul

ADAPTER LK 1M

- LK LeoniKerpen eLine / BKS NewLine fixing standard
- communication module not included



ADAPTER NEXANS/SCHRACK 2M

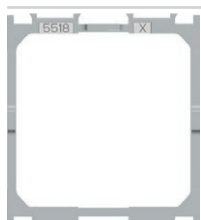

KA26

- pričvršćivanje adaptera za Nexans LANmark i module Schrack 45x45mm
- prikladno za tip Nexan N423.540N
- prikladno za tip Schrack HSEMD02W2F
- nije ugrađen komunikacijski modul

ADAPTER NEXANS/SCHRACK 2M

- fixing adapter for Nexans LANmark and Schrack module 45x45mm
- suitable for Nexans type N423.540N
- suitable for Schrack type HSEMD02W2F
- communication module not included

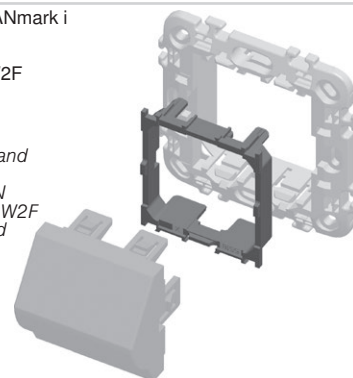

ADAPTER AT&T SYSTIMAX SA ZAŠTITOM OD PRAŠINE 1M



- KM48PW
- KM48SB
- KM48AT
- KM48ES
- KM48IW

- AT&T Systimax standard pričvršćivanja sa zaštitom od prašine
- nije ugrađen komunikacijski modul

ADAPTER AT&T SYSTIMAX WITH DUST PROTECTION 1M

- AT&T Systimax fixing standard with dust protection
- communication module not included



UTIČNICA USB TIP A 1M



- KM51PW
- KM51SB
- KM51AT
- KM51ES
- KM51IW

- USB 2.0 utičnica tip A
- vijčano pričvršćivanje, raster 5 mm, 1,5 mm², 1x2P + 1x3P
- spajanje:
 - PIN 1 – VCC (+5V, crvena žica)
 - PIN 2 – Data - (bijela žica)
 - PIN 3 – Data + (zelena žica)
 - PIN 4 – GND - uzemljenje (crna žica)
 - S – zaštita
- sukladno direktivi 2011/95/EU (RoHS2)

SOCKET USB TYPE A 1M

- USB 2.0 socket type A
- screw contacts, raster 5 mm, 1,5 mm², 1x2P + 1x3P
- wiring:
 - PIN 1 – VCC (+5V, red wire)
 - PIN 2 – Data - (white wire)
 - PIN 3 – Data + (green wire)
 - PIN 4 – GND - ground (black wire)
 - S – shield
- in accordance with directive 2011/95/EU (RoHS2)



1M = 22,5 x 45
2M = 45 x 45

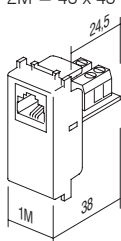

KM30

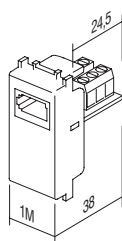

KM31

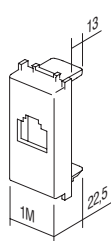

KM35
KM38
KM48

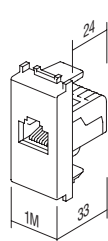

KM36
KM37
KM39

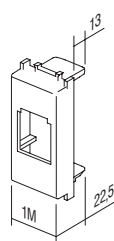

KM40
KM43

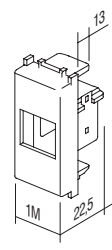

KM45

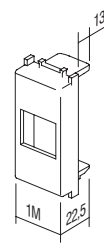

KM46
KM47
KM50
KM52
KM53

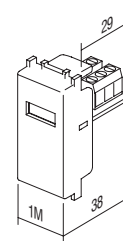

KM51

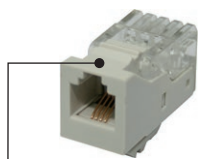

KA10

tip type	naziv description	tehnički podaci technical data
KA10	KONEKTOR KS CAT3 CONNECTOR KS CAT3	RJ11 6/4
KA11	KONEKTOR KS CAT5e CONNECTOR KS CAT5e	RJ45 8/8
KA12	KONEKTOR KS CAT5eS CONNECTOR KS CAT5eS	RJ45 8/8
⋮	⋮	⋮



KA10	KONEKTOR KS CAT3 RJ11 6/4 - KS keystone standard pričvrščivanja - CAT3, RJ11 6/4 - skladno normi IEC 60603-7 <i>CONNECTOR KS CAT3 RJ11 6/4</i> - KS keystone fixing standard - CAT3, RJ11 6/4 - in accordance with IEC 60603-7
------	--



KA11	KONEKTOR KS CAT5e RJ45 8/8 - KS keystone standard pričvrščivanja - CAT5e, RJ45 8/8 - skladno normi IEC 60603-7 <i>CONNECTOR KS CAT5e RJ45 8/8</i> - KS keystone fixing standard - CAT5e, RJ45 8/8 - in accordance with IEC 60603-7
------	--



KA12	KONEKTOR KS CAT5eS RJ45 8/8 - KS keystone standard pričvrščivanja - CAT5eS, RJ45 8/8 - skladno normi IEC 60603-7 <i>CONNECTOR KS CAT5eS RJ45 8/8</i> - KS keystone fixing standard - CAT5eS, RJ45 8/8 - in accordance with IEC 60603-7
------	--



KA15	KONEKTOR KS CAT6 SCH RJ45 8/8 - KS keystone standard pričvrščivanja - CAT6 UTP bezalatna montaža, RJ45 8/8 - skladno normi ISO/IEC 11801 <i>CONNECTOR KS CAT6 SCH RJ45 8/8</i> - KS keystone fixing standard - CAT6 UTP toolless, RJ45 8/8 - in accordance with ISO/IEC 11801
------	---



KA16	KONEKTOR KS CAT6S SCH RJ45 8/8 - KS keystone standard pričvrščivanja - CAT6S STP bezalatna montaža, RJ45 8/8 - skladno normi ISO/IEC 11801 <i>CONNECTOR KS CAT6S SCH RJ45 8/8</i> - KS keystone fixing standard - CAT6S STP toolless, RJ45 8/8 - in accordance with ISO/IEC 11801
------	---



KA17	KONEKTOR KS CAT6a SCH RJ45 8/8 - KS keystone standard pričvrščivanja - CAT6a STP bezalatna montaža, RJ45 8/8 - skladno normi ISO/IEC 11801 <i>CONNECTOR KS CAT6a SCH RJ45 8/8</i> - KS keystone fixing standard - CAT6a STP toolless, RJ45 8/8 - in accordance with ISO/IEC 11801
------	---



KA18

KONEKTOR TANKI KS CAT6S SCH RJ45 8/8

- KS keystone standard pričvršćivanja
- tanki dizajn
- CAT6S STP bezalatna montaža, RJ45 8/8
- sukladno normi ISO/IEC 11801
- prikladno i s KE46 dvostrukim adapterom

CONNECTOR SLIM KS CAT6S SCH RJ45 8/8

- KS keystone fixing standard
- slim style
- CAT6S STP toolless, RJ45 8/8
- in accordance with ISO/IEC 11801
- suitable also for KE46 double adapter



KA27

KONEKTOR KS HDMI

- KS keystone standard pričvršćivanja
- samo u kombinaciji s adapterom KM50
- HDMI/HDMI

CONNECTOR KS HDMI

- KS keystone fixing standard
- only in combination with adapter KM50
- HDMI/HDMI



KA28

KABEL KS HDMI

- KS keystone standard pričvršćivanja
- samo u kombinaciji s adapterom KM50
- HDMI/HDMI

CABLE KS HDMI

- KS keystone fixing standard
- only in combination with adapter KM50
- HDMI/HDMI



EM31



PW



tip type	naziv description	tehnički podaci technical data	veličina size	boja colour
EM12	REGULATOR OSVJETLJENJA ROTACIJSKI IZMJENIČNI DIMMER ROTATIVE 2WAY	RL 300W	1M	<input type="checkbox"/> PW bijela sjajna polar white <input type="checkbox"/> SB crna mat soft touch black <input type="checkbox"/> AT antracit anthracite <input type="checkbox"/> ES srebrna mat elox silver <input type="checkbox"/> IW bež sjajna ivory white
EM23	UGRADBENI ZATAMNJIVAČ DIMMER INBOX	R (250 W), (RC,RL 200VA)	/	<input type="checkbox"/> BL plava blue <input type="checkbox"/> RD crvena red <input type="checkbox"/> GR zelena green <input type="checkbox"/> OR narančasta orange <input type="checkbox"/> RG crveno-zelena red/green
.
.

REGULATOR OSVJETLJENJA ROTACIJSKI IZMJENIČNI RL 300W 1M



- EM12PW
- EM12SB
- EM12AT
- EM12ES
- EM12IW

- rotacijski s izmjeničnom sklopkom
- opterećenje RL, 40 W – 300 W
- napajanje 230 V~ 50 Hz
- moguća je kombinacija s izmjeničnom sklopkom
- zajedničko montiranje više uređaja u jednu dozu dopušteno je isključivo pod uvjetom da njihovo ukupno maksimalno opterećenje ne premašuje maksimalnu snagu jedne sklopke za zatamnjivanje
- dopušteno je korištenje samo jedne sklopke za zatamnjivanje po strujnom krugu
- osigurač nije montiran – morate upotrijebiti vanjski osigurač
- sukladno normi EN 60669-1
- vijčano pričvršćivanje vodiča presjeka 1,5 – 2,5 mm²
- integrirana LED rasvjeta označava razinu zatamnjivanja

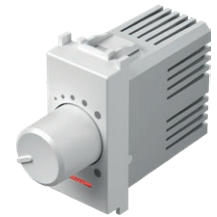

DIMMER ROTATIVE/2WAY RL 300W 1M

- rotation control with 2-way switch
- load RL, 40W - 300W
- supply voltage 230V~ 50Hz
- 2-way switch combination is possible
- installing several devices together in one box is only permitted if their total maximum load does not exceed the maximum power of a single dimmer
- one circuit allows the use of only one dimmer
- no built-in fuse – external fuse must be used
- in accordance with EN 60669-1
- screw contacts - 1.5-2.5mm²
- integrated LED indication of dimming level

REGULATOR OSVJETLJENJA ROTACIJSKI IZMJENIČNI LED 60W 1M



- EM13PW
- EM13SB
- EM13AT
- EM13ES
- EM13IW

- rotacijski s izmjeničnom sklopkom
- opterećenje:
LED, 0 – 60 W (maks. 6 LED tinjalica s regulacijom osvjetljenja)
GLS, 0 – 60 W
- napajanje 230 V~ 50 Hz
- moguća je kombinacija s izmjeničnom sklopkom
- zajedničko montiranje više uređaja u jednu dozu dopušteno je isključivo pod uvjetom da njihovo ukupno maksimalno opterećenje ne premašuje maksimalnu snagu jedne sklopke za zatamnjivanje
- dopušteno je korištenje samo jedne sklopke za zatamnjivanje po strujnom krugu
- osigurač nije montiran – morate upotrijebiti vanjski osigurač
- sukladno normi IEC60669-2-1
- vijčano pričvršćivanje vodiča presjeka 1,5 – 2,5 mm²

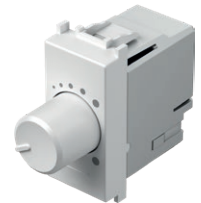

DIMMER ROTATIVE/2WAY LED 60W 1M

- rotation control with 2-way switch
- loads: LED, 0 – 60W (max. 6 dimmable LED lamps)
GLS, 0 – 60W
- supply voltage 230V~ 50Hz
- 2-way switch combination is possible
- installing several devices together in one box is only permitted if their total maximum load does not exceed the maximum power of a single dimmer
- one circuit allows the use of only one dimmer
- no built-in fuse – external fuse must be used
- in accordance with IEC60669-2-1
- screw contacts - 1.5-2.5mm²

REGULATOR OSVJETLJENJA ROTACIJSKI IZMJENIČNI LED 180W 1M



- EM14PW
- EM14SB
- EM14AT
- EM14ES
- EM14IW

- rotacijski s izmjeničnom sklopkom
- opterećenje:
 - LED, 0 – 180 W (maks. 20 LED tinjalica s regulacijom osvjetljenja)
 - GLS, 0 – 180 W
- napajanje 230 V~ 50 Hz
- moguća je kombinacija s izmjeničnom sklopkom
- zajedničko montiranje više uređaja u jednu dozu dopušteno je isključivo pod uvjetom da njihovo ukupno maksimalno opterećenje ne premašuje maksimalnu snagu jedne sklopke za zatamnjivanje
- dopušteno je korištenje samo jedne sklopke za zatamnjivanje po strujnom krugu
- osigurač nije montiran – morate upotrijebiti vanjski osigurač
- sukladno normi IEC60669-2-1
- vijčano pričvršćivanje vodiča presjeka 1,5 – 2,5 mm²

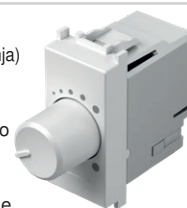

DIMMER ROTATIVE/2WAY LED 180W 1M

- rotation control with 2-way switch
- loads:
 - LED, 0 – 180W (max. 20 dimmable LED lamps)
 - GLS, 0 – 180W
- supply voltage 230V~ 50Hz
- 2-way switch combination is possible
- installing several devices together in one box is only permitted if their total maximum load does not exceed the maximum power of a single dimmer
- one circuit allows the use of only one dimmer
- no built-in fuse – external fuse must be used
- in accordance with IEC60669-2-1
- screw contacts - 1.5-2.5mm²

REGULATOR OSVJETLJENJA ROTACIJSKI R 250W 1M



- EM15PW
- EM15SB
- EM15AT
- EM15ES
- EM15IW

- rotacijski bez sklopke
- opterećenje R, 40W – 250W
- mrežni napon 230V~ 50Hz
- nije moguća kombinacija s izmjeničnom sklopkom
- povezivanje više regulatora osvjetljenja nije dopušteno
- sukladno normi EN 60669-1
- vijčano pričvršćivanje vodiča presjeka 1,5-2,5mm²
- LED indikacija



DIMMER ROTATIVE R 250W 1M

- rotation control without switch
- load R, 40W - 250W
- supply voltage 230V~ 50Hz
- 2-way switch combination is not possible
- more dimmers combination is not allowed
- in accordance with EN 60669-1
- screw contacts 1.5-2.5mm²
- LED indication

1 – 10 V ZATAMNJIVAČ ROTACIJSKI IZMJENIČNI



- EM16PW
- EM16SB
- EM16AT
- EM16ES
- EM16IW

- nominalni radni napon: 10VDC
- minimalni radni napon: 0,7 VDC
- područje zatamnjivanja:
 - 0,7 % – 100 % (ovisno o napajaju i opterećenju)
- minimalna odvodna struja: 0,1 mA
- maksimalna odvodna struja: 120 mA
- maksimalna potrošnja: 0,35 W
- prenaponska zaštita:
 - 15,8 VDC do 250 mA (nezamjenjiva)
- najveća impulsna struja: 3ADC
- vrsta opterećenja: 0 – 10 V, 1 – 10 V i PWM
- vrsta sklopke: mehanička:
 - uključivanje/isključivanje na pritisak
- nulni vodič: nije potreban
- nominalni radni napon: 100 – 240 VAC, 50 – 60 Hz
- maksimalna trenutačna struja: 10 A
- maksimalna radna struja: 8 A
- maksimalno opterećenje (pri 230 VAC): 1800 VA (1800 x pf = maks. W)
- izolacijski otpor > 100 MΩ pri 250 VAC
- prenaponska zaštita i zaštita od kratkog spoja: 10 A, 350 VAC (nezamjenjiva)
- rotacijski kut: 270° ± 5°
- temperatura rada: -5 °C do 40 °C
- temperatura skladištenja: -30 °C do 80 °C
- maksimalna temperatura kućišta: 65 °C
- maksimalna vlažnost: 90 % (bez kondenzacije)
- EMC i imunost: CISPR 15(2008), IEC 61547
- LVD: IEC 60669-1:2017, IEC 60669-2-1:2015



1-10 V DIMMER ROTARY TOGGLE

- nominal operating voltage: 10 VDC
- minimum operating voltage: 0.7 VDC
- dimming range: 0.7% – 100% (depending on power supply and loads)
- minimum sink current: 0.1 mA
- maximum sink current: 120 mA
- maximum consumption: 0.35 W
- surge protection: 15.8 VDC up to 250 mA (not replaceable)
- maximum pulse current: 3 ADC
- load types: 0-10 V, 1-10 V and PWM
- switch type: mechanical: push on/off
- zero cable: not required
- nominal operating voltage: 100-240 VAC, 50-60 Hz
- maximum instantaneous current: 10 A
- maximum operating current: 8 A
- maximum load (at 230 VAC): 1800 VA (1800 x pf = max. W)
- isolation resistance: > 100 MΩ at 250 VAC
- surge protection and Short-circuit protection: 10 A, 350 VAC (not replaceable)
- rotation angle: 270° ± 5°
- operating temperature: -5 to 40°C
- storing temperature: -30 to 80°C
- maximum housing temperature: 65°C
- maximum humidity: 90% (no condensation)
- EMC & immunity: CISPR 15(2008), IEC 61547
- LVD: IEC 60669-1:2017, IEC 60669-2-1:2015



EM23

UGRADBENI ZATAMNJIVAČ R (250 W), (RC,RL 200VA)

- ugradbeni, za povezivanje s tipkalom
- opterećenje RLC 15-250W ili 15-200 VA
- napajanje 230 V~ 50Hz
- moguće povezivanje više tipkala
- nije dopušteno povezivanje više zatamnivača
- ugrađena memorijska funkcija
- funkcija mekog uključivanja/isključivanja
- »leading edge«
- kompatibilan s EN60669, EN60950, EN 61000, ETSI EN 300 220-1, ETSI EN 300 220-2
- vijčana montaža vodiča do presjeka 2,5 mm²

DIMMER INBOX R (250 W), (RC, RL 200 VA)

- inbox, controlled by external push button
- load RLC 15-250W or 15-200 VA
- supply voltage 230V~ 50Hz
- several push-buttons combinations are possible
- more dimmers combination is not allowed
- light intensity memory
- soft start/stop function
- »leading edge«
- in accordance with EN60669, EN60950, EN 61000, ETSI EN 300 220-1, ETSI EN 300 220-2
- screw contacts to wires 2,5 mm²



EM18

UGRADBENI ZATAMNJIVAČ LED 250 W

- ugradbeni, za povezivanje s tipkalom
- leading ili trailing edge
- napajanje 230 V~ 50 Hz
- moguće povezivanje više tipkala
- funkcija memoriranja zadnje postavke, osim u slučaju nestanka struje
- funkcija mekog uključivanja/isključivanja
- postavljanje minimalnog osvjetljenja
- montaža samo jednog uređaja u jednu dozu
- samo za unutrašnju uporabu
- uskladen s normama EN 60669-1 i EN 60669-2-1

DIMMER INBOX LED 250W

- inbox, controlled by external push button
- for leading or trailing edge
- supply voltage 230V~ 50Hz
- several push-buttons combinations is possible
- memory function of the last setting, except in the case of a power failure
- soft start / stop function
- minimum intensity control
- only one dimmer per wall box
- only for indoor usage
- in accordance with EN 60669-1 and EN 60669-2-1



EM19

UGRADBENI ZATAMNJIVAČ DC LED 96 W

- ugradbeni, za povezivanje s tipkalom
- povezanost sa svim jedinicama napajanja LED rasvjete sa stalnim naponom i nekim jedinicama napajanja LED rasvjete sa stalnim tokom, 9 – 48 V DC, max 96 W
- nije namijenjeno uporabi s induktivnim opterećenjem
- moguće povezivanje više tipkala i zatamnivača
- funkcija memoriranja zadnje postavke, osim u slučaju nestanka struje
- funkcija mekog uključivanja/isključivanja
- montaža samo jednog uređaja u jednu dozu
- samo za unutrašnju uporabu

DIMMER INBOX DC LED 96W

- inbox, controlled by external push button
- for use with constant voltage LED drivers and some constant current LED drivers, 9-48V DC, max 96W (also for LED strips)
- not for use with inductive loads
- several push-buttons combinations and several dimmers is possible
- memory function of the last setting, except in the case of a power failure
- soft start / stop function
- only one dimmer per wall box
- only for indoor usage

EM15 (40÷250W)

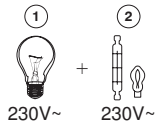

EM12 (40÷300W)

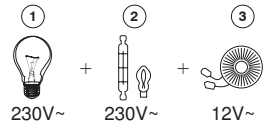

EM13 (0÷60W), EM14 (0÷180W),
EM23 (15÷250W, 15÷200VA),
EM18 (2÷250VA (3=10÷250VA), 2÷250W)

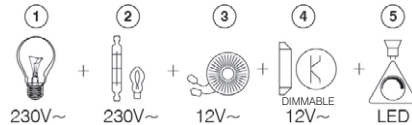

- 1 - žarulja sa žarnom niti / incandescent lamp
- 2 - halogena žarulja / halogen lamp
- 3 - klasični transformator / classical transformer
- 4 - elektronički transformator s regulacijom osvijetljenja / dimmable electronic transformer
- 5 - LED tinjalica s regulacijom osvijetljenja / dimmable LED lamp

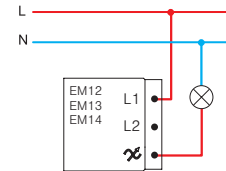
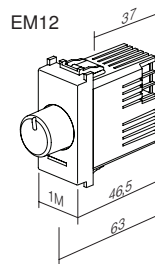
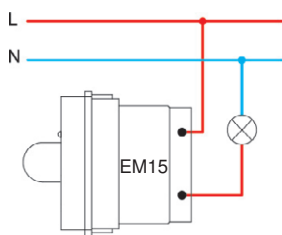
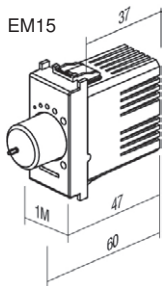

EM23

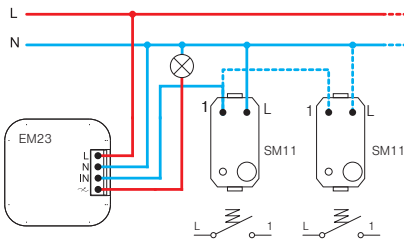
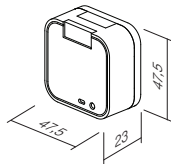

EM13, EM14

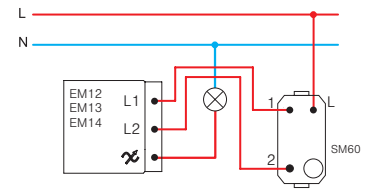
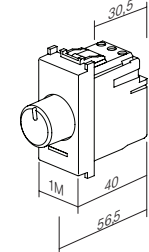

EM18

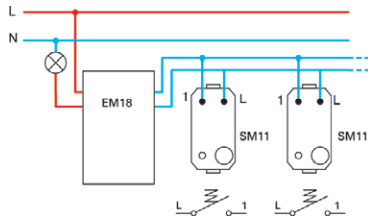
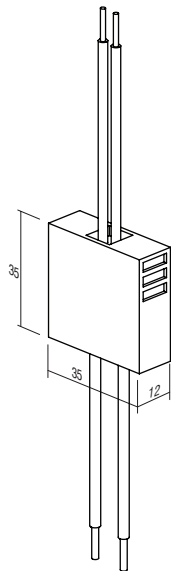

EM19

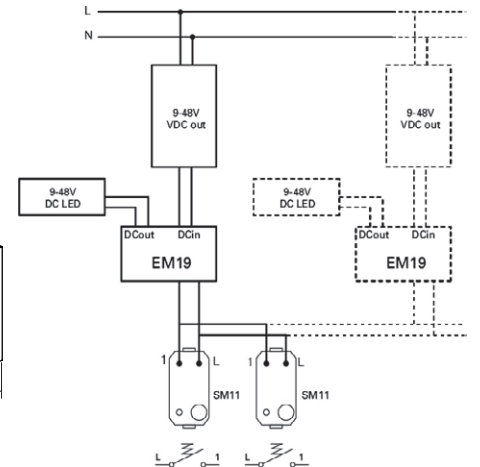
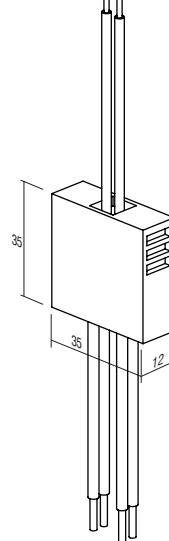

POZOR!

Ako se više regulatora osvijetljenja priključi u jednu kutiju, za svaki se dodatni regulator smanjuje maksimalna ukupna snaga za 10%.

ATTENTION!

If more dimmers are connected in one box reduce maximum common power for 10% for each dimmer.

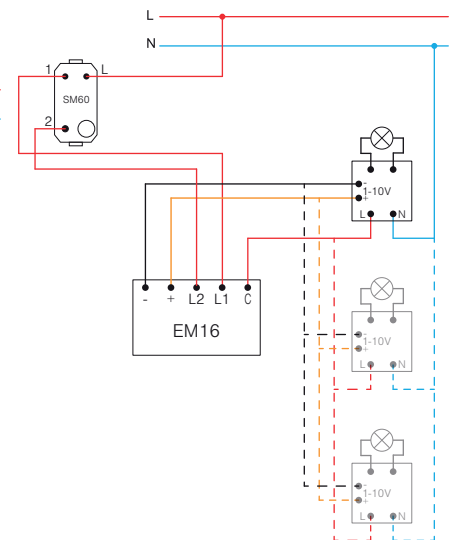
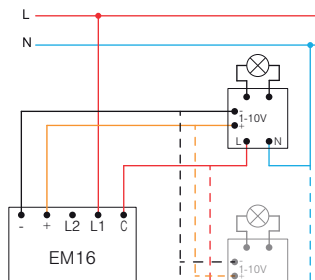
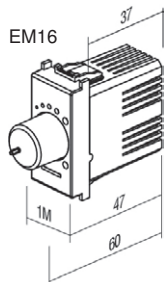
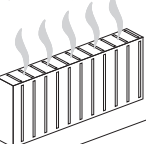

SKLOPKA / REGULATOR OSVJETLJENJA UNIVERZALNI RLC 0-300W 2M

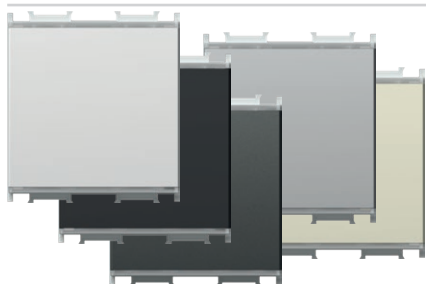

- EM25PW
- EM25SB
- EM25AT
- EM25ES
- EM25IW

- univerzalni elektronički regulator osvjetljenja za uključivanje i isključivanje i regulaciju osvjetljenja svih zatamnjenih žarulja (klasična, halogena, LED, CFL, ...) i nekih vrsta nezatamnjenih
- automatska detekcija tipa tinjalice i prilagodba režima rada
- smanjenje potrošnje energije
- funkcija usporenog starta produljuje vijek trajanja tinjalice
- kontrola preko ugrađene mikrosklopke
- ugrađena funkcija memorije – pri gašenju memorira stupanj svjetlosti
- može se priključiti do pet (5) dodatnih kontrolnih jedinica EM26
- nije moguće kombiniranje s izmjeničnom sklopkom
- ugrađena zaštita od kratkog spoja, pregrijavanja i preopterećenja
- mrežni napon 230V ~ 50Hz
- elegantno LED osvjetljenje, prilagodljiva boja i stupanj osvjetljenja
- moguća zamjena klasične sklopke u dvožičnom spoju⁽¹⁾
- potpuna funkcionalnost postiže se u trožičnom spoju⁽²⁾
- sukladno normama EN 60669-1 i EN 60669-2-1
- vijčano pričvršćivanje vodiča presjeka 1,5 mm² (maks. moment zatezanja 0,4 Nm)



TOUCH EM25 je mikroprocesorski upravljani zatamnivač svjetla. Služi kao sklopka te zatamnivač za zatamnjive i neke vrste nezatamnjenih žarulja. Ugrađeni mikroprocesor automatski prepoznaje vrstu žarulje i prilagođava način rada. Pamti razinu zatamnjenja nakon isključivanja, zahvaljujući ugrađenoj memorijskoj funkciji. Funkcija polaganog paljenja produžava vijek trajanja žarulje. U tipku integrirana elegantna LED rasvjeta omogućava razne boje i razine intenziteta. Moguće je spojiti do 5 dodatnih upravljačkih sklopki EM26 („slave“).

TOUCH EM25 is microprocessor controlled electronic light dimmer. It serves as switch and dimmer for dimmable and some of non-dimmable lamps. Integrated microprocessor automatically identifies the type of lamp and adjusts the operating mode. It remembers the level of dimming after switching off due to integrated memory function. Soft-start function extends the lamp service life. In button integrated elegant LED illumination enables many different colours and intensity levels. Optionally one can connect up to 5 additional control tasters EM26 (»slave«).

SWITCH / DIMMER UNIVERSAL RLC 0-300W 2M

- universal electronic dimmer for ON/OFF switching and dimming of all dimmable lamps (classical, halogen, LED, CFL, ...) and some non-dimmable lamps
- automatic detection of lamp type and adjustment of operating mode
- reduction of energy consumption
- soft start function extends life of lamps
- controlled by build-in micro switches
- memory function included – memorizes brightness on turn-off
- up to five (5) additional control units EM26 can be connected
- connection with 2-way switch is not possible
- build-in short-circuit, overheating and overload protection
- supply voltage 230V ~ 50Hz
- elegant LED illumination, adjustable colour and brightness
- replacement of classical switch is possible at two-wire connection⁽¹⁾
- full functionality is achieved at three-wire connection⁽²⁾
- in accordance with EN 60669-1 and EN 60669-2-1
- screw contacts 1.5mm² (max. tightening torque 0.4Nm)

⁽¹⁾ dvožični spoj
two-wire connection

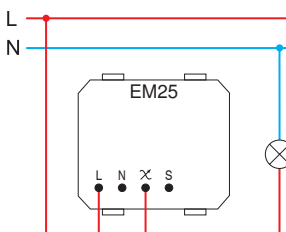

⁽²⁾ trožični spoj
three-wire connection

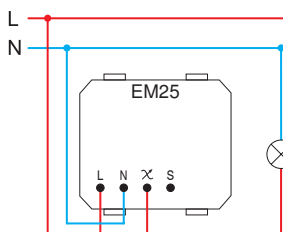

- dvožičano spajanje omogućava zatamnjenje zatamnjenih žarulja
- two-wire connection allows dimming of dimmable lamps

- trožičano spajanje omogućava zatamnjenje zatamnjenih žarulja te nekih nezatamnjenih LED i CFL lampi
- three-wire connection allows dimming of dimmable lamps and some of non-dimmable LED and CFL lamps

	1	2	5	6	7
Min.	40 W	40 W	40 VA	40 VA	40 VA
Max.	300 W	300 W	300 VA	100 VA	100 VA
	(F)	(F)	(F)		

- 1 - žarulja sa žarnom niti / incandescent lamp
- 2 - halogena žarulja / halogen lamp
- 4 - elektronički transformator s regulatorom osvjetljenja / dimmable electronic transformer
- 5 - klasični transformator / classical transformer

	1	2	4	6	7	8	9
Min.	0 W	0 W	0 VA	0 VA	0 VA	0 VA	0 VA
Max.	300 W	300 W	120 VA	120 VA	120 VA	120 VA	120 VA
	(F)	(F)	(F)			(F)	(F)

- 6 - štedna CFL tinjalica s regulacijom osvjetljenja / dimmable energy saving CFL lamp
- 7 - LED tinjalica s regulacijom osvjetljenja / dimmable LED lamp
- 8 - štedna CFL tinjalica bez regulacije osvjetljenja / non-dimmable energy saving CFL lamp
- 9 - LED tinjalica bez regulacije osvjetljenja / non-dimmable LED lamp

napomene / remarks

- (F) filter EM27
- preporučujemo korištenje EM27 filtra / it is recommended to use filter EM27
- sve spojene žarulje moraju biti jednake / all controlled lamps must be the same
- tablica opterećenja vrijedi za žarulje s faktorom PF>0,5 / table of loads is valid for lamps with power factor PF>0.5

paljenje / gašenje te zatamnivanje žarulje /
on / off switching and dimming of lamp

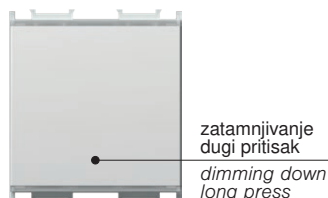
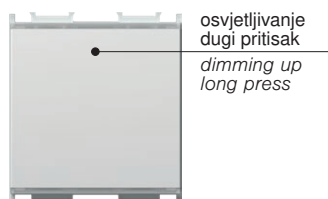
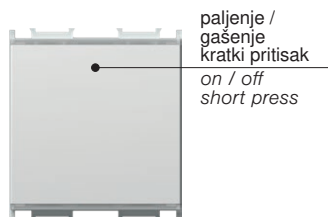

odabir boje i podešavanje intenziteta LED osvjetljenja /
LED colour selection and intensity level adjustment

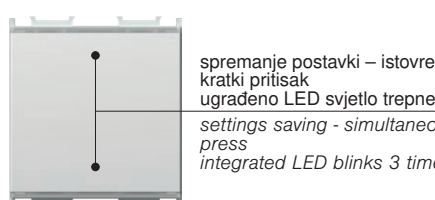
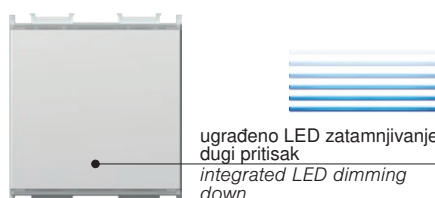
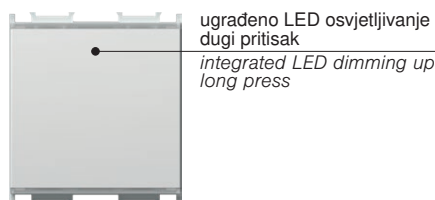
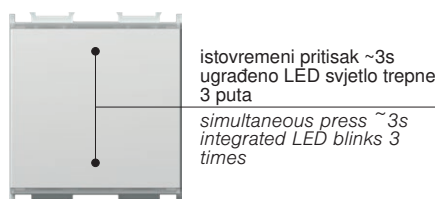

*funkcija "RESET" /
"RESET" function

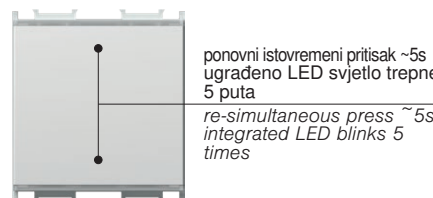
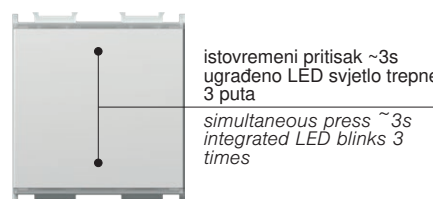
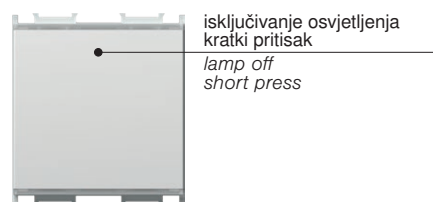

- * - preporučuje se za ugradnju zatamnivača i pri zamjeni žarulje
- obavezno kod korištenja nezatamnjivih žarulja
- funkcija "RESET" nije dostupna kod korištenja dvožičanog spajanja
- moguće samo za EM25
- it is recommended at dimmer installation and lamp replacement
- mandatory when using non-dimmable lamps
- "RESET" function is not possible when using two-wire connection
- only possible on EM25

upozorenja za ugradnju /
installation precautions

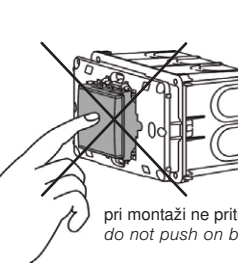
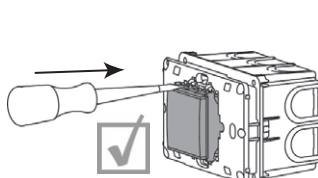
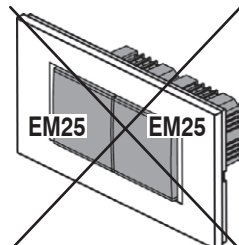
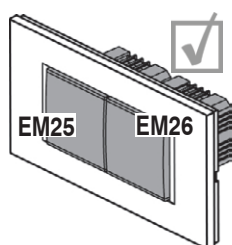

pri montaži ne pritišćite tipku /
do not push on button during mounting

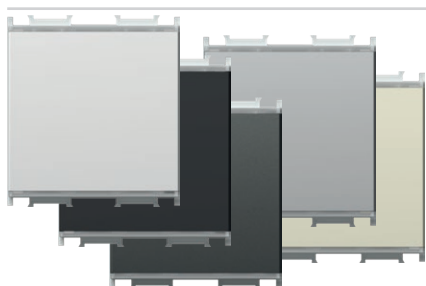

- EM26PW
- EM26SB
- EM26AT
- EM26ES
- EM26IW

UPRAVLJAČKA JEDINICA - TIPKALO 2M

- priključena na univerzalni regulator osvjjetljenja dopušta upravljanje tinjalicama s istom funkcionalnošću kao EM25
- mrežni napon 230V~ 50Hz
- sukladno normama EN 60669-1 i EN 60669-2-1
- vijčano pričvršćivanje vodiča presjeka 1,5 mm² (maks. moment zatezanja 0,4 Nm)

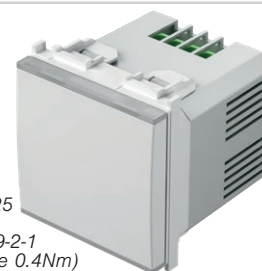

PUSH-BUTTON CONTROL UNIT 2M

- connected to universal dimmer EM25 allows controlling of lamps with same functionality as EM25
- supply voltage 230V~ 50Hz
- in accordance with EN 60669-1 and EN 60669-2-1
- screw contacts 1.5mm² (max. tightening torque 0.4Nm)

⁽¹⁾ dvožični spoj
two-wire connection

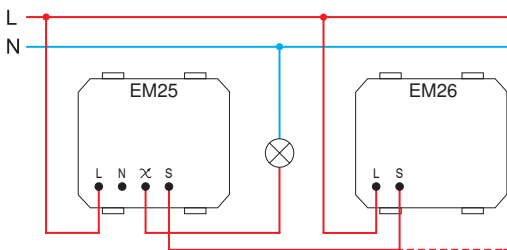

- dvožičano spajanje omogućava zatamnivanje zatamnjivih žarulja
- kod dvožičnog spajanja korištenje svake dodatne upravljačke jedinice povećava minimalno opterećenje za 25W

- two-wire connection allows dimming of dimmable lamps
- in a two-wire connection each additional control unit increases the minimum load by 25W

⁽²⁾ trožični spoj
three-wire connection

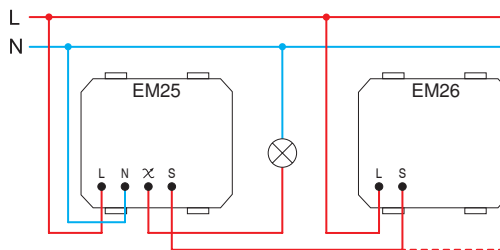

- trožičano spajanje omogućava zatamnivanje zatamnjivih žarulja te nekih nezatamnjivih LED i CFL lampi

- three-wire connection allows dimming of dimmable lamps and some of non-dimmable LED and CFL lamps

FREKVENCIJSKI FILTAR

EM27

- filter frekvencijskih smetnji za EM25
- prikaz je simboličan

FREQUENCY FILTER

- frequency filter for EM25
- image is symbolic

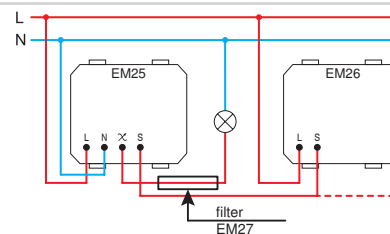

SET SKLOPKA / REGULATOR OSVJETLJENJA UNIVERZALNI RLC 0-300W 2M PP OL20

EM25PPOL20

- set uključuje regulator osvjjetljenja EM25, ugradbeni nosač 2M i okvir LINE 2M PW
- za tehničke detalje pogledajte EM25

SET SWITCH / DIMMER UNIVERSAL RLC 0-300W 2M PP OL20

- set includes dimmer EM25, mounting frame 2M and cover plate LINE 2M PW
- for technical details see EM25

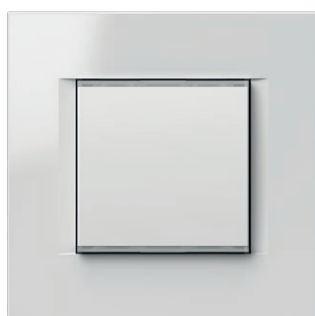

2M = 45 x 45

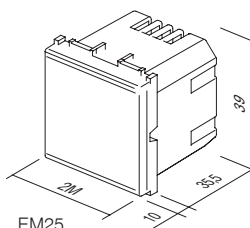

EM25
EM26

IR SKLOPKA 5A 230V~ 1M



- EM31PW
- EM31SB
- EM31AT
- EM31ES
- EM31IW

- IR infracrvena sklopka
- napajanje: 230V~ ± 10% 50Hz
- relej: 5A / 250V~ (zero crossing)
- zaštitna razina: IP40
- presjek žica na kontaktnom terminalu: 0,75 - 2,5 mm²
- kut prepoznavanja: do 110° pri 20 °C
- raspon prepoznavanja: približno 8m pri 20 °C
- prilagodljivost trajanja: od približno 5 s do 12 min
- prilagodljivost osvetljenja: od približno 5 do 200 LUX
- temperatura radnog okruženja: od 0 °C do +40 °C
- nije prikladan za ugradnju u kutije duboke 45 mm te podžbukne kutije CUBO IP20
- samo za unutrašnju uporabu



IR SWITCH 5A 230V~ 1M

- IR infrared switch
- supply voltage: 230V~ ±10 % 50Hz
- relay: 5A / 250V~ (zero crossing)
- protection rating: IP40
- cross-section of wires at the contact terminal: 0.75 - 2.5 mm²
- detection angle: up to 110° at 20°C
- detection area: approx. 8 m at 20°C
- adjustability of duration: from approx. 5 s to 12 min
- adjustability of brightness: from approx. 5 to 200 LUX
- operating temperature: from 0°C to +40°C
- not suitable for installation in 45 mm deep boxes and surface mount box CUBO IP20
- only for indoor usage

IR SKLOPKA 5A 230V~ 2M

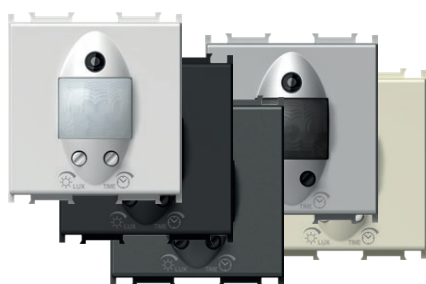

- EM32PW
- EM32SB
- EM32AT
- EM32ES
- EM32IW

- IR infracrvena sklopka
- napajanje: 230V~ ± 10% 50Hz
- relej: 5A / 250V~ (zero crossing)
- zaštitna razina: IP40
- presjek žica na kontaktnom terminalu: 0,75 - 2,5 mm²
- kut prepoznavanja: do 110° pri 20 °C
- raspon prepoznavanja: približno 8m pri 20 °C
- prilagodljivost trajanja: od približno 5 s do 12 min
- prilagodljivost osvetljenja: od približno 5 do 200 LUX
- temperatura radnog okruženja: od 0 °C do +40 °C
- nije prikladan za ugradnju u kutije duboke 45mm te podžbukne kutije CUBO IP20
- samo za unutrašnju uporabu



IR SWITCH 5A 230V~ 2M

- IR infrared switch
- supply voltage: 230V~ ±10 % 50Hz
- relay: 5A / 250V~ (zero crossing)
- protection rating: IP40
- cross-section of wires at the contact terminal: 0.75 - 2.5 mm²
- detection angle: up to 110° at 20°C
- detection area: approx. 8 m at 20°C
- adjustability of duration: from approx. 5 s to 12 min
- adjustability of brightness: from approx. 5 to 200 LUX
- operating temperature: from 0°C to +40°C
- not suitable for installation in 45 mm deep boxes and surface mount box CUBO IP20
- only for indoor usage

moгуćnost raspoznavanja
detection range

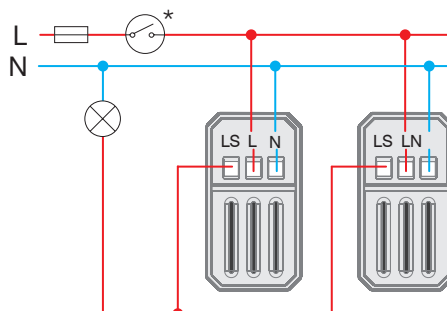
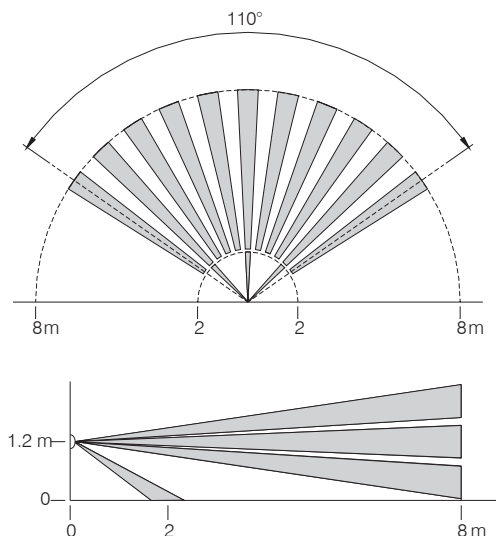

E L E C T R O N I C S E M

podešavanje vremena i osjetljivosti /
time and twilight adjustment

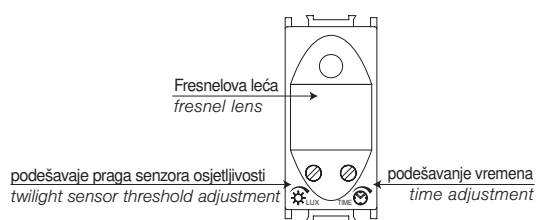

5 LUX	200 LUX	
	~5 s	~12 min

	1	2	3	4	5	6	7	8
Min.	1 W	1 W		1 VA	1 W	1 W	1 VA	1 VA
Max.	800 W	800 W	5A	6x20 VA	6x36 W	4x36 W (20μF)	6x23 VA	6x20 VA

1 - žarulja sa žarnom niti /
incandescent lamp

2 - halogena žarulja /
halogen lamp

3 - otporan grijaći element /
resistive heating element

4 - elektronički transformator /
electronic transformer

5 - fluorescentna cijev (izvedba 1) /
fluorescent tube (version 1)

6 - fluorescentna cijev (izvedba 2) /
fluorescent tube (version 2)

7 - štedna CFL žarulja /
energy saving CFL lamp

8 - LED žarulja /
LED lamp

upozorenja /
attention

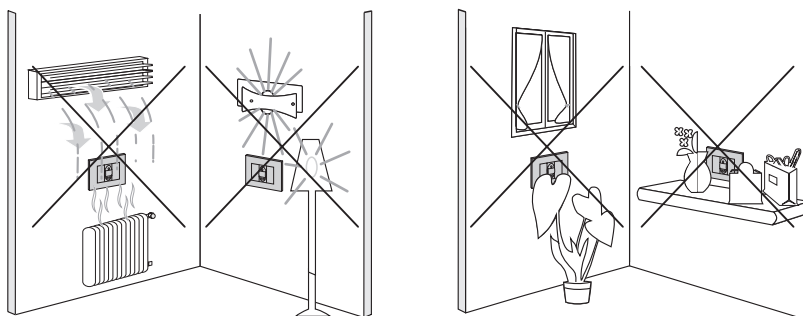

1M = 22,5 x 45

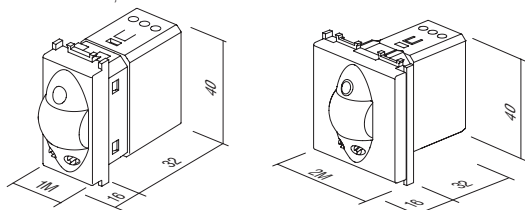

TERMOSTAT OSNOVNI 6A 230V~ 2M



- EM37PW
- EM37SB
- EM37AT
- EM37ES
- EM37IW

- elektronički termostat, osnovni
- način rada: grijanje / hlađenje / isključeno
- napajanje: 230 VAC, 50 Hz
- izlaz: 6(2) A, 230 VAC, relejna sklopka
- raspon regulacije: +10 °C do +30 °C
- histereza: ±0.5 °C, ED = 20min
- zaštita protiv smrzavanja (način grijanja): +6 °C
- zaštita protiv pregrijavanja (način hlađenja): +32 °C
- funkcija ECO za snižavanje temperature za 3 °C za 6 sati u načinu grijanja te povećanja temperature za 3 °C za 6 sati u načinu hlađenja
- prilagođena ECO funkcija, svaki dan automatski u isto vrijeme snižava temperaturu za 3 °C unutar 6 sati u načinu grijanja te povećava temperaturu za 3 °C unutar 6 sati u načinu hlađenja
- mogućnost uključivanja ECO funkcije vanjskim okidačem putem odvojenog unosa, LED indikator načina rada
- nije prikladan za električno podno grijanje
- vijčano pričvršćivanje vodiča presjeka maks. 2.5 mm²
- sukladno s LV Direktivom, EMC Direktivom, standardima EN60730-1 te EN60730-2-9
- za pravilno korištenje preporučujemo instaliranje u zasebnu kutiju, odvojenu od uređaja koji stvaraju toplinu
- temperatura korištenja: 5 ÷ 35 °C
- temperatura skladištenja: -20 ÷ 50 °C



Termostat je namijenjen reguliranju temperature u prostoru. Termostat omogućava dva načina rada – grijanje ili hlađenje. Ugrađene su i sigurnosne funkcije protiv smrzavanja (način grijanja) te protiv pregrijavanja (način hlađenja). Način rada se označava preko LED osvjjetljenja. Postavke termostata unose se pomoću okretnog mehanizma za postavljanje temperature te s drugim kapacitivnim dodirnim tipkama.

The thermostat is intended for regulating temperature in a room. A thermostat enables two modes of operation – heating or cooling. It has safety functions installed for protection against freezing (heating mode) and protection against overheating (cooling mode). The operation is indicated via LED lights. Thermostat setup is performed with the help of a rotary button for setting the temperature and with other capacitive touch buttons.

THERMOSTAT BASIC 6A 230 V ~ 2M

- electronic thermostat, basic
- operation mode: heating/cooling/turn off
- power supply: 230 VAC, 50 Hz
- output: 6(2) A, 230 VAC, relay switch
- regulation range: +10 °C to +30 °C
- hysteresis: ±0.5 °C, ED = 20min
- anti-freeze protection (heating mode): +6 °C
- overheating protection (cooling mode): +32 °C
- ECO function for lowering the temperature by 3 °C for 6 hours in the heating mode and raising temperature by 3 °C for 6 hours in the cooling mode
- adaptive ECO function, automatically every day at the same time lowers the temperature by 3 °C for 6 hours in the heating mode and raises temperature by 3 °C for 6 hours in the cooling mode
- option to turn on the ECO operating mode by external trigger via a separate input
- LED indication of operation
- not suitable for electrical floor heating
- screw contacts max. 2.5 mm²
- in accordance with the LV Directive, the EMC Directive, standards EN60730-1 and EN60730-2-9
- for correct operation, we recommend installing in an independent single box, separate from devices that generate heat
- operating temperature: 5 ÷ 35 °C
- storage temperature: -20 ÷ 50 °C

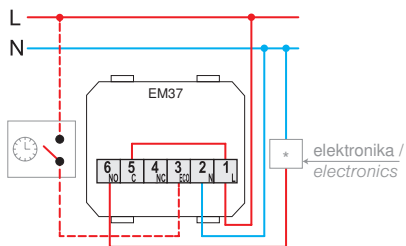

cirkulacijska crpka, plamenik (direktno spajanje) /
termoelektrični pogon /
circulation pump, burner (direct connection) /
thermoelectric drive

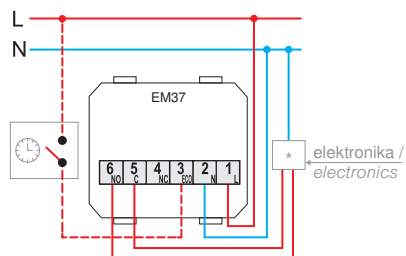

bojler, toplinska crpka, plamenik (upravljajući unos T1/T2) /
boiler, heat pump, burner (control input T1/T2)

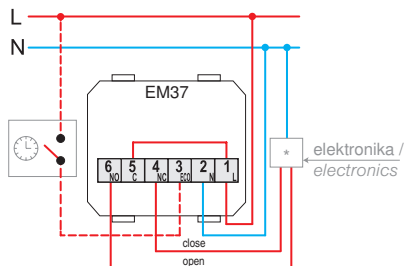

motorni pogon (ograničena uporaba s podnim grijanjem) /
motor drive (limited use with underfloor heating)

postavljanje načina rada i temperature /
function and temperature adjustment

tipka za izbor načina rada i LED indikator stanja:
crvena: grijanje
plava: hlađenje
ne svijetli: isključeno

function selection button and LED status indicator:
red: heating
blue: air conditioning
no light: switched off

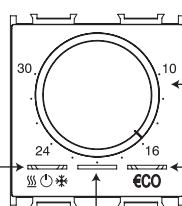

postavljanje temperature /
temperature setting

tipka za izbor "ECO" načina i LED indikator "ECO" načina
zeleno: ECO ušteda energije UKLJUČENA
narančasta: aktiviran prilagođeni ECO način
ne svijetli: dnevni način

"ECO" function selection button and LED "ECO" status indicator
green: ECO energy saving ON
orange: adaptive ECO mode activated
no light: day mode

LED indikator stanja izlaznog releja
bijela: relej uključen
ne svijetli: relej isključen

LED output relay state indicator
white: relay ON
no light: relay OFF

upozorenja /
attention

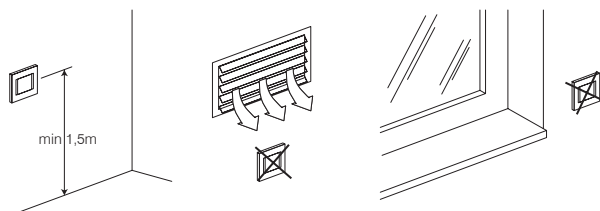

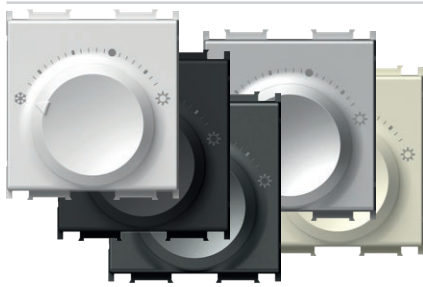

- EM38PW
- EM38SB
- EM38AT
- EM38ES
- EM38IW

TERMOSTAT GRIJANJE 5(2) A 230 V~ 2M

- Način rada: grijanje
- Napajanje: 230 VAC, 50 Hz
- Naponski puls: 4 kV
- Potrošnja energije: < 0,5 W
- Izlaz: 2 A (maks. 5 A); 230 VAC, 50 Hz
- Izlazni priključak: NO (maks. 10 aktuatora)
- Raspon regulacije: +5 °C do +30 °C
- Zaštita protiv smrzavanja: +5 °C
- Histereza: 0,5 K
- Zaštita: IP30
- Vrsta senzora: Bimetal
- Vrsta električnog priključka: Opružni kontakti
- Vrsta vodiča: 0,75 - 1,5mm² (meka žica); 1,0 - 2,5 mm² (tvrda žica)
- U skladu s direktivom DIN EN 60730



HEATING THERMOSTAT 5(2)A 230V~ 2M

- operation mode: heating
- power supply: 230 VAC, 50 Hz
- voltage pulse: 4 kV
- energy consumption: < 0.5 W
- output: 2 A (max. 5 A); 230 VAC, 50 Hz
- switching output: NO (max. 10 actuators)
- regulation range: +5°C to +30°C
- frost protection: +5°C
- hysteresis: 0.5 K
- protection: IP30
- sensor type: Bimetal
- type of electrical connection: Spring-loaded contacts
- type of conductors: 0.75 – 1.5 mm² (flexible-stranded core); 1.0 – 2.5 mm² (solid core)
- in compliance with Directive DIN EN 60730

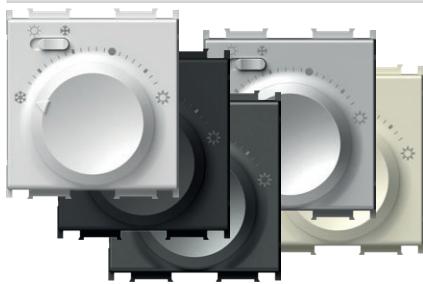

- EM39PW
- EM39SB
- EM39AT
- EM39ES
- EM39IW

TERMOSTAT GRIJANJE/HLADENJE 3(1,5) A 230 V~ 2M

- Način rada: grijanje / hlađenje
- Napajanje: 230 VAC, 50 Hz
- Naponski puls: 4 kV
- Potrošnja energije: < 0,5 W
- Izlaz: 1.5 A (maks. 3 A); 230 VAC, 50 Hz
- Izlazni priključak: preklopna sklopka (maks. 5 aktuatora)
- Raspon regulacije: +5 °C do +30 °C
- Zaštita protiv smrzavanja: +5 °C
- Histereza: 0,5 K
- Zaštita: IP30
- Vrsta senzora: Bimetal
- Vrsta električnog priključka: Opružni kontakti
- Vrsta vodiča: 0,75 - 1,5mm² (meka žica); 1,0 - 2,5 mm² (tvrda žica)
- U skladu s direktivom DIN EN 60730



HEATING/COOLING THERMOSTAT 3(1.5)A 230V~ 2M

- operation mode: cooling/heating
- power supply: 230 VAC, 50 Hz
- voltage pulse: 4 kV
- energy consumption: < 0.5 W
- output: 1 A (max. 3 A); 230 VAC, 50 Hz
- switching output: mode selector switch (max. 5 actuators)
- regulation range: +5°C to +30°C
- frost protection: +5°C
- hysteresis: 0.5 K
- protection: IP30
- sensor type: Bimetal
- type of electrical connection: Spring-loaded contacts
- type of conductors: 0.75 - 1.5mm² (flexible-stranded core); 1.0 - 2.5 mm² (solid core)
- in compliance with the Directive DIN EN 60730

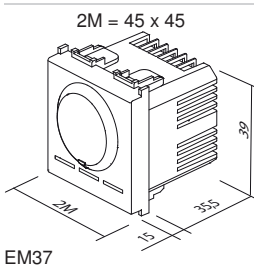

EM37

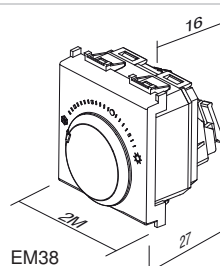

EM38

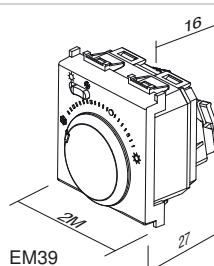

EM39

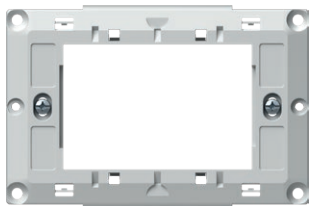

NM39

NOSAČ S VIJCIMA ZA TERMOSTATE FANTINI COSMI 3M

- nosač s vijcima za termostate Fantini Cosmi 3M
- prikladan za korištenje s dnevnim termostatima Fantini Cosmi modela CH121 i CH123
- prikladan za korištenje s tjednim termostatima Fantini Cosmi modela CH141A i CH143A
- ugrađnja u pravokutne kutije 3M
- prikladan za kombiniranje s okvirima PURE, Line, Soft

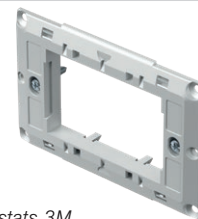

MOUNTING FRAME WITH SCREWS FOR FANTINI COSMI THERMOSTATS 3M

- mounting frame with screws for Fantini Cosmi thermostats 3M
- suitable for use with Fantini Cosmi daily thermostats models CH121 and CH123
- suitable for use with Fantini Cosmi weekly thermostats models CH141A and CH143A
- for mounting in rectangular boxes 3M
- suitable for assembling with cover plates PURE, Line, Soft



- EM40PW
- EM40SB
- EM40AT
- EM40ES
- EM40IW

ŠTEDNA KARTIČNA SKLOPKA 3A 250V~ 3M

- osnovna kartična sklopka, za bilo koju ISO karticu
- mrežni napon 230V~ 50Hz
- izlaz: 3A 250V~ za sklopnik*
- zadržka isklopa 15-20s
- sukladno normi EN 61000-6-1
- kartica nije priložena
- nije za kontrolu pristupa



ENERGY SAVER CARD SWITCH 3A 250V~ 3M

- card switch basic, any ISO card
- supply voltage 230V~ 50Hz
- output 3A 250V~ for switching contactor *
- switch off delay 15-20s
- in accordance with EN 61000-6-1
- card is not included
- not for access control

3M = 67,5 x 45

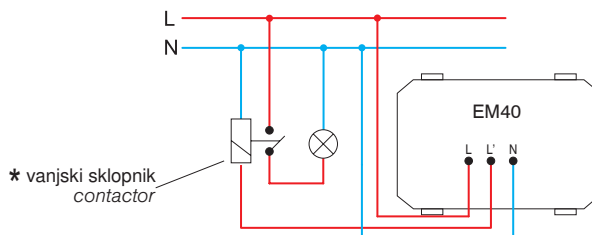
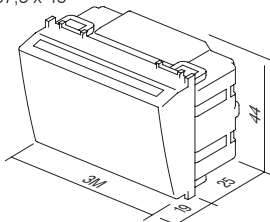

* vanjski sklopnik
contactor



EM47

KARTICA ISO

- ISO kartica
- za uporabu s kartičnom sklopkom EM40
- veličina: 85x54 mm

CARD ISO

- ISO card
- for combination with card switch EM40
- size: 85x54 mm



EM44BK

ŠTEDNA KARTIČNA SKLOPKA RF HF 13,56MHz 3M

- kartična sklopka elektronska za RFID ISO karticu
- napajanje iz relejne jedinice EM49 putem kablovskih konektora RJ12
- izlaz treba biti spojen na relejni izlaz EM49
- 15-20s zadržka isklopa „glavnog napajanja“ s povlačenjem kartice
- 1 min zadržka isklopa „HVAC“ s povlačenjem kartice prilikom otvaranja balkonskih vrata ili prozora
- sukladno normi EN 61000-6-1
- kartica nije priložena
- nije za kontrolu pristupa

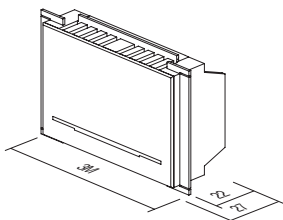
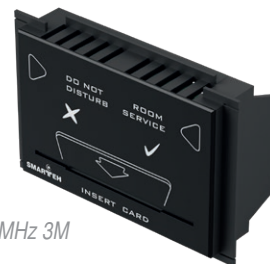

ENERGY SAVER CARD SWITCH RF HF 13,56MHz 3M

- electronic card switch for RFID ISO card
- supply from relay unit EM49 through cable connectors RJ12
- output to be connected to relay output unit EM49
- 15-20s "main power" switch off delay with card withdrawal
- 1 min "HVAC" switch off delay with card withdrawal when balcony doors or windows opened
- in accordance with EN 61000-6-1
- card is not included
- not for access control

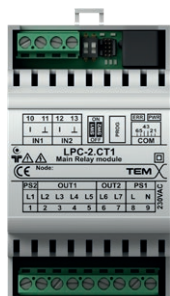

EM49

ŠTEDNA KONTROLNA JEDINICA 2x16A 250V~

- relejna jedinica za kartične sklopke EM44
- mrežni napon 230V~ 50Hz
- sukladno normi EN 61000-6-1
- montaža na DIN tračnicu 35 mm, 4MU
- ulaz i izlaz ovisno o primjeni: jednokrevetna ili dvokrevetna soba

ENERGY SAVER CONTROL UNIT 2x16A 250V~

- relay unit for card switches EM44
- supply voltage 230V~ 50Hz
- in accordance with EN 61000-6-1
- mounting on DIN rail 35mm, 3MU
- input and output depending on implementation: single or double room

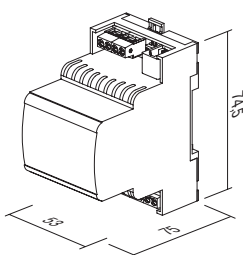

EM45

RAZDVAJAČ SPL-1

- koristi se za spajanje dva periferna modula EM44 s relejnom jedinicom EM49
- komunikacijski konektor RJ12
- veličina: 37 x 30 x 27 mm

SPLITTER SPL-1

- used to connect two peripheral modules EM44 to relay unit EM49
- communication connector RJ12
- size: 37 x 30 x 27 mm

dijagram spajanja za primjenu u jednokrevetnoj sobi / wiring diagram for single room implementation

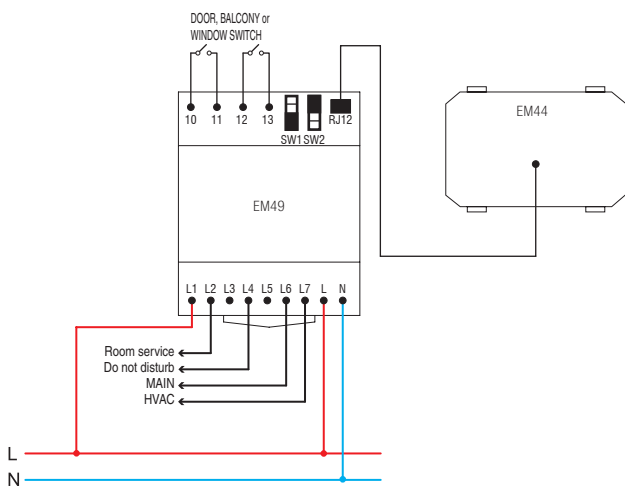

dijagram spajanja za primjenu u dvokrevetnoj sobi / wiring diagram for double room implementation

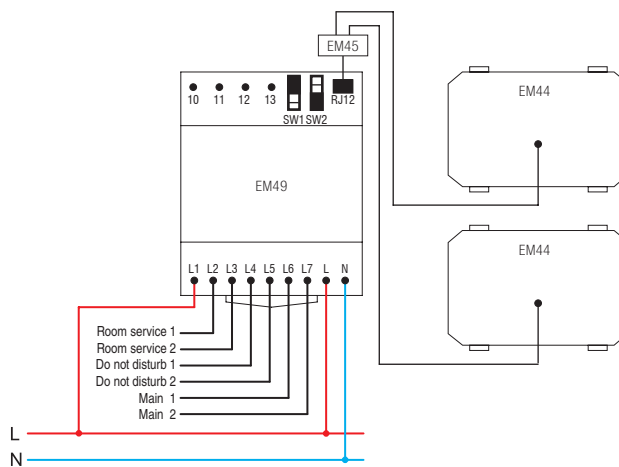

priključni kabel RJ12 između EM44 i EM49 / connection cable RJ12 between EM44 and EM49

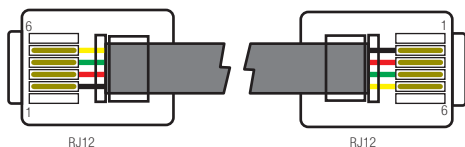

UTIČNICA ZA BRIJAČI APARAT 230V~/120V~ 3M



- EM60PW
- EM60SB
- EM60AT
- EM60ES
- EM60IW

- utičnica za brijači aparat s izolacijskim transformatorom 20VA
- napajanje: 230V~ 50-60Hz
- izlaz: 230V~ za 2P 2,5A euro utikac ili 120V~ za 2P 15A američki utikac
- razred II
- sukladno normi EN 61558-2-5



SOCKET SHAVER 230V~/120V~ 3M

- shaver supply unit with isolating transformer 20VA
- supply: 230V~ 50-60Hz
- output: 230V~ for 2P 2.5A Europlug or 120V~ for 2P 15A American plug
- Class II
- in accordance with EN 61558-2-5

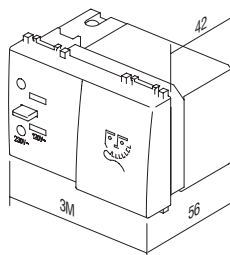

3M = 67,5 x 45

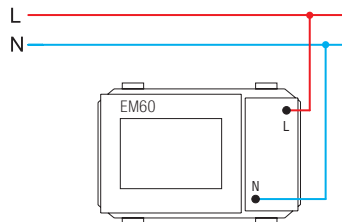

JEDINICA NAPAJANJA 5V 2,4A 1M



- EM67PW
- EM67SB
- EM67AT
- EM67ES
- EM67IW

- Za punjenje elektroničkih uređaja putem standardnog USB priključka (sukladno i s Apple uređajima)
- napajanje: 100 – 230 V~ 50/60 Hz
- potrošnja: 300 mA pri 100 V~/150 mA pri 230 V~
- potrošnja pri mirovanju: 30 mW pri 230 V~
- nazivni izlazni napon: 5 VDC (±5 %) SELV
- njihanje (ripple) izlaznog napona: 150 mV
- nazivna izlazna snaga: 2,4A (±10 %)
- učinkovitost: maks. 77 %
- radna temperatura: 0 °C/+ 45 °C (unutarnja uporaba)
- IP zaštitni razred: IP20, samo za unutarnju uporabu
- gurnosni razred uređaja II
- prenaponska kategorija (EN 62109): Klasa III
- vijčano pričvršćivanje vodica presjeka maks. 2,5 mm²
- uređaj s razmakom kontakta od najmanje 3 mm
- sukladno standardu EN 60950-1 te LVD i EMC direktivama

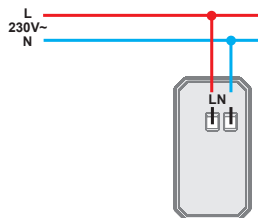
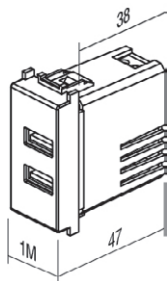

USB POWER SUPPLY UNIT 5V 2.4A 1M

- for charging of electronic devices via a standard USB port (also compatible with Apple devices)
- power supply: 100-230V~ 50/60Hz
- power consumption: 300mA at 100V~/150mA at 230V~
- standby power consumption: 30mW at 230V~
- nominal output voltage: 5 VCD (± 5%) SELV
- output ripple voltage: 150mV
- nominal output current: 2,4A (±10%)
- efficiency: maximum of 77%
- operating temperature: 0°C/+45°C (indoor use)
- IP protection class: IP20, indoor use only
- class device II
- overvoltage category (EN 62109): Class III
- screw contacts: max. 2.5 mm²
- device with a contact gap of at least 3mm
- in accordance with EN 60950-1 and LVD & EMC directives

USB PUNJAČ 5 V 3,0 A



- EM68PW
- EM68SB
- EM68AT
- EM68ES
- EM68IW

- za punjenje elektroničkih uređaja preko standardnog USB priključka (sukladno i s Apple uređajima)
- napajanje: 100 – 230 V~ 50/60 Hz
- potrošnja energije: 300 mA pri 100 V~ / 150 mA pri 230 V~
- potrošnja pri mirovanju: 30 mW pri 230 V~
- nazivni izlazni napon: 5 VCD ($\pm 5\%$) SELV
- nihanje (ripple) izlaznog napona: 150 mV
- nazivna izlazna snaga: 3,0 A ($\pm 10\%$)
- vrsta konektora: USB A / USB C
- učinkovitost: maks. 77%
- radna temperatura: 0 °C / +45 °C (unutrašnja uporaba)
- IP zaštitni razred: IP20, samo za unutrašnju uporabu
- sigurnosni razred uređaja II
- prenaponska kategorija (EN 62109): Klasa III
- vijčano pričvršćivanje vodiča presjeka maks. 2,5 mm²
- uređaj s razmakom kontakta od najmanje 3 mm
- sukladno standardu EN 60950-1 te LVD i EMC direktivama

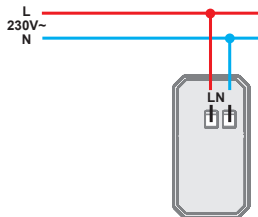
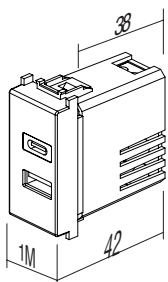

USB POWER SUPPLY UNIT 5V 3,0A

- for charging of electronic devices via a standard USB port (also compatible with Apple devices)
- power supply: 100-230V~ 50/60Hz
- power consumption: 300mA at 100V~/150mA at 230V~
- standby power consumption: 30mW at 230V~
- nominal output voltage: 5 VCD ($\pm 5\%$) SELV
- output ripple voltage: 150mV
- nominal output current: 3,0 A ($\pm 10\%$)
- connector type: USB A / USB C
- efficiency: maximum of 77%
- operating temperature: 0°C/+45°C (indoor use)
- IP protection class: IP20, indoor use only
- class device II
- overvoltage category (EN 62109): Class III
- screw contacts: max. 2.5 mm²
- device with a contact gap of at least 3mm
- in accordance with EN 60950-1 and LVD & EMC directives

LED SVJETILKA ZA SLUČAJ NUŽDE 250V~ 0.9W, NiCd 3h 7M



- EM55

- LED svjetiljka za slučaj nužde
- mrežni napon 250V~ 50Hz 3xLED 0,3W LED, 10000mcd, 6500K
- NiCd akumulator 400 mAh, zamjenjiv
- autonoman rad 3 h, punjenje 24 h
- razred II
- sukladno normama EN 60598-1, EN 60598-2-2



LED EMERGENCY LIGHT 250V~ 0.90W, NiCd 3h 7M

- emergency LED lamp
- supply voltage 250V~ 50Hz 3x LED 0,3W, 10000mcd, 6500K
- NiCd accumulator 400 mAh, replaceable
- autonomy 3h, charging 24h
- Class II
- in accordance with EN 60598-1, EN 60598-2-2, EN 60598-2-22

7M = 151,5 x 45

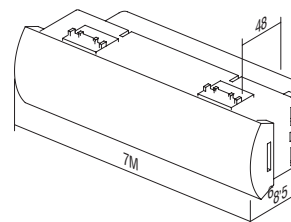
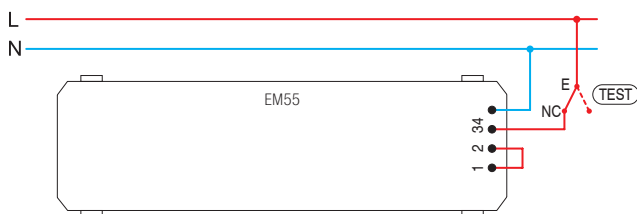

LED SVJETILKA ZA SLUČAJ NUŽDE 230V~ 50 Hz 0,5W, NiMH 2h 2M



- EM57

- LED svjetiljka za slučaj nužde
- može se upotrebljavati kao prijenosna ručna svjetiljka (mehanizam na izvlačenje)
- mrežni napon 230V~ 50Hz 1xLED 0,5W
- NiMH akumulator 140 mAh, zamjenjiv
- autonoman rad 2 h, punjenje 36 h
- razred II
- sukladno normama EN 60598-1, EN60598-2-2, EN62471, EN55015:2006, EN61547

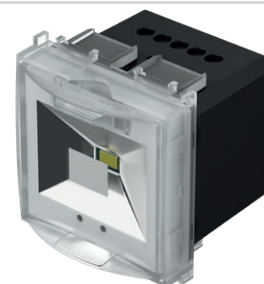

LED EMERGENCY LIGHT 230V~50Hz, 0.5W, NiMH 2h 2M

- emergency LED lamp
- option to use it as a hand lamp (pull-out mechanism)
- supply voltage 230V~ 50Hz, 1xLED 0.5W
- NiMH accumulator 140mAh, replaceable
- autonomy 2h, charging 36h
- class device II
- in accordance EN60598-1, EN60598-2-2, EN62471, EN55015:2006, EN61547

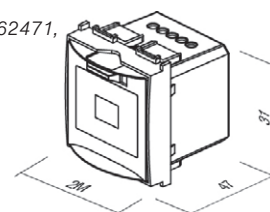
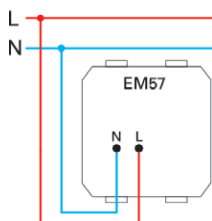

LED SVJETILJKA JEDNOBOJNA 250V~ 0,8W 2M

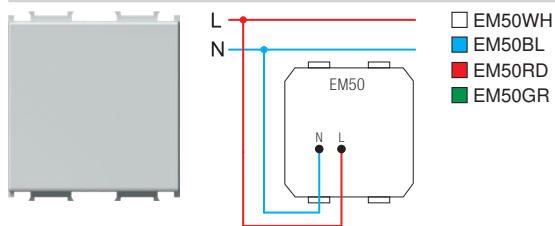

- LED svjetiljka za označavanje stepenica
- mrežni napon 230V~ 50Hz 0,8W, 6500K
- razred II
- sukladno normi EN 60598-1
- opcionalna uporaba za osvijetljavanje pravca ili signaliziranje s laserskom gravurom na difuzeru prema želji korisnika

LED LAMP MONOCOLOR 250V~ 0,8W 2M

- step marker LED lamp
- supply voltage 230V~ 50Hz 0,8W, 6500K
- Class II
- in accordance with EN 60598-1
- optional usage for directional or signal illumination with customized laser printing on diffuser



LED SVJETILJKA DVOBOJNA 250V~ 2x0,4W 2M

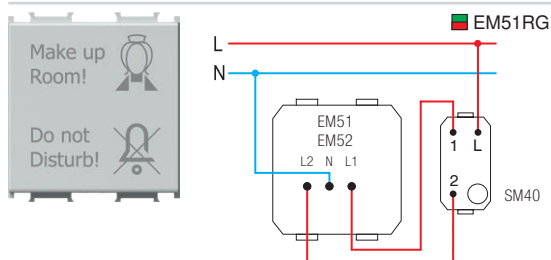

- LED svjetiljka s dvobojnom signalizacijom (crveno/zelenom)
- mrežni napon 230V~ 50Hz 2x0,4W, 6500K
- razred II
- sukladno normi EN 60598-1
- difuzer obuhvaća i grafiku prema prikazu
- moguć laserski otisak na difuzeru prema želji korisnika

LED LAMP DUAL COLOR 250V~ 2x0,4W 2M

- signaling dual color (red/green) LED lamp
- supply voltage 230V~ 50Hz 2x0,4W, 6500K
- Class II
- in accordance with EN 60598-1
- diffuser includes graphics as shown
- possible customized laser printing on diffuser



LED SVJETILJKA 3D DVOBOJNA 250V~ 2x0,4W 2M

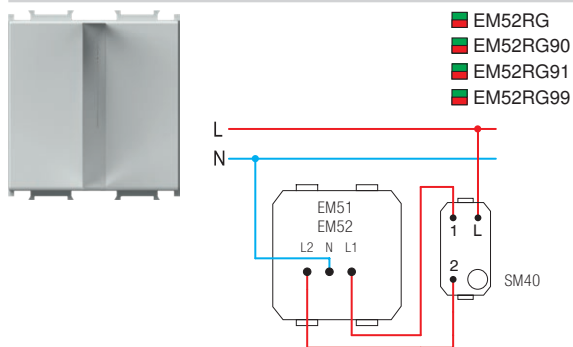

- LED dvobojna svjetiljka (crvena/zelena) s 3D simbolom, za označavanje
- mrežni napon 230V~ 50Hz 2x0,4W, 6500K
- razred II
- sukladno normi EN 60598-1
- mogućnost otiska prilagođenih grafika po želji
- 90 muških simbola, 91 ženski simbol, 99 simbola na zahtjev

LED LAMP 3D DUAL COLOR 250V~ 2x0,4W 2M

- signalling LED lamp, dual color (red/green) with 3D symbol
- supply voltage 230V~ 50Hz 2x0,4W, 6500K
- class II
- in accordance with EN 60598-1
- possible customized graphics on request
- 90 male symbol, 91 female symbol, 99 symbol on request

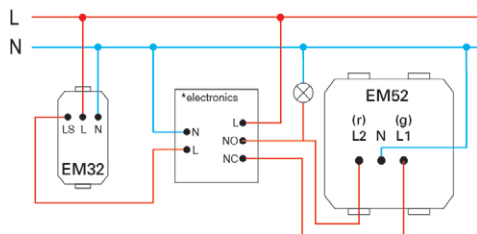
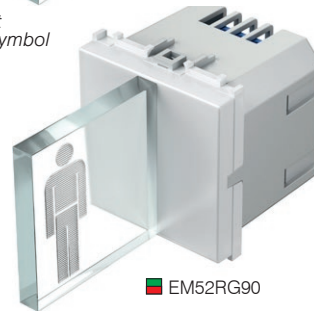
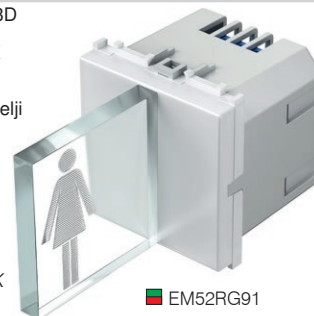

2M = 45 x 45

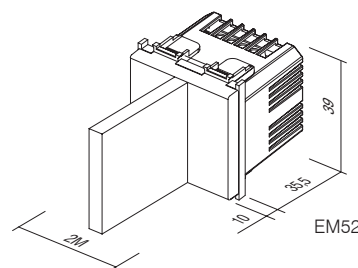
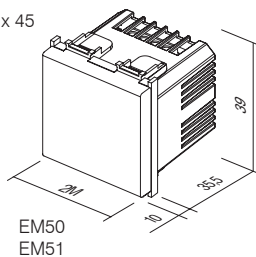

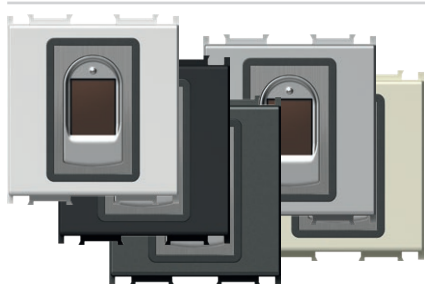

- EM71PW
- EM71SB
- EM71AT
- EM71ES
- EM71IW

PREKIDAČ NA OTISAK PRSTA BIOPASS 2M

- prekidač na otisak prsta u kompletu s unutarnjom relejnom jedinicom i uređajem za napajanje
- kapacitet: 500 otisaka prsta
- jednostavno upravljanje s pomoću mobilne aplikacije X-Manager
- napon napajanja: 8 – 30 V – DC ili AC (uređaj za napajanje uključen)
- kapacitivni senzor
- 2 izlazna releja
- maksimalni napon/struja na releju: 40 V/3 A
- vrijeme pokretanja releja: 1 – 10 s
- maksimalna snaga: 3,6 W
- 256-bitna enkripcija veze između prekidača i unutarnje relejne jedinice
- Set također uključuje nosač NM24 i dekorativni okvir OS20.

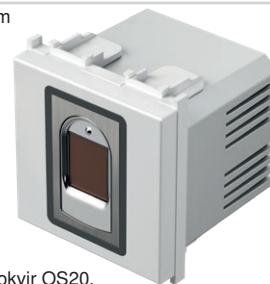

FINGERPRINT SWITCH BIOPASS 2M

- fingerprint switch with included internal relay unit and power supply
- capacity: 500 fingerprints
- easy management via X-Manager mobile app
- power supply voltage: 8-30V – DC or AC (power supply included)
- capacitive sensor
- 2 output relays
- maximum voltage/current on relay: 40V/3A
- relay triggering time: 1-10 sec
- maximum power: 3.6W
- 256-bit encrypted link between switch and internal relay unit
- Set also includes NM24 mounting frame and OS20 decorative cover plate.

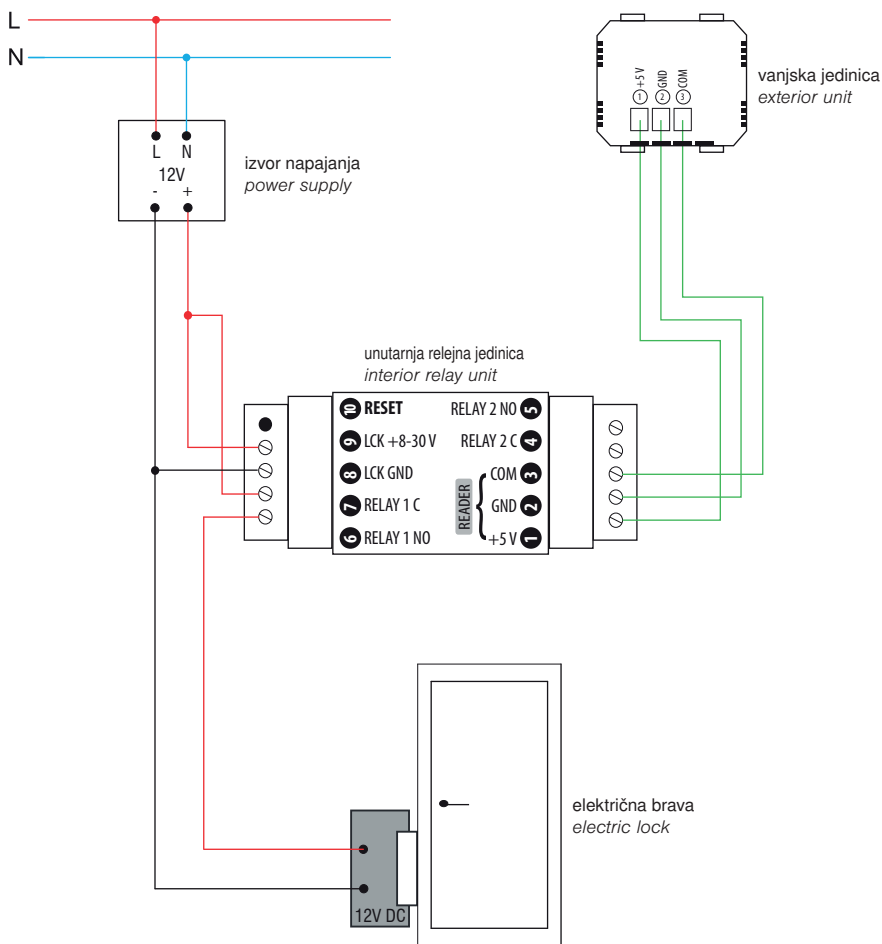

X-Manager app



support.tem.si



vanjska jedinica exterior unit

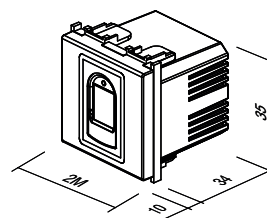

SKLOPKA, BESKONTAKTNA 10A 240V~



■ EM80GW

- beskontaktna sklopka za uključivanje i isključivanje („glavna“)
- napajanje: 240 V~ 50 Hz
- izlazni relej 10A / 250V~ (2400W pri 240V~)
- prilagodljivi raspon od 2 do 10 cm
- namijenjeno za ugradnju u standardnu okruglu kutiju Ø60 mm
- neutralan kabel (N) je potreban za spajanje
- nije moguće kombiniranje izmjeničnom sklopkom
- moguće je povezivanje s do 5 EM81 upravljačkih sklopki
- jednostavna ugradnja dekorativnih poklopaca uz pomoć magneta
- vijčano pričvršćivanje kabela do 2.5 mm² (maks. vijčani moment zatezanja 0.4 Nm)
- sukladno normama EN 60669-1 i EN 60669-2-1
- samo za unutrašnju uporabu



SWITCH, TOUCHLESS 10A 240V~

- touchless switch for turning on/off (“master”)
- power supply: 240 V~ 50 Hz
- output relay 10A / 250V~ (2400W at 240V~)
- adjustable range from 2 to 10 cm
- intended for installation into a standard round Ø60 mm box
- a neutral lead (N) is required for connection
- connection with toggle switches is not possible
- connection with up to 5 EM81 control switches is possible
- simple installation of decorative covers with the help of magnets
- screw fastening of leads up to 2.5 mm² (max. screw tightening torque is 0.4 Nm)
- in accordance with EN 60669-1 and EN 60669-2-1
- only for indoor use



■ EM81GW

SKLOPKA, BESKONTAKTNA, UPRAVLJAČKA JEDINICA

- upravljačka sklopka (“slave”)
- radi samo kad je spojena sa sklopkom EM80 („glavna“)
- prilagodljivi raspon od 2 do 10 cm
- jednostavna ugradnja dekorativnih poklopaca uz pomoć magneta
- vijčano pričvršćivanje kabela do 2.5 mm² (maks. vijčani moment zatezanja 0.4 Nm)
- sukladno normama EN 60669-1 i EN 60669-2-1
- samo za unutrašnju uporabu



SWITCH, TOUCHLESS, CONTROL UNIT

- control switch (“slave”)
- works only when connected with the EM80 switch (“master”)
- adjustable range from 2 to 10 cm
- simple installation of decorative covers with the help of magnets
- screw fastening of leads up to 2.5 mm² (max. screw tightening torque is 0.4 Nm)
- in accordance with EN 60669-1 and EN 60669-2-1
- only for indoor use

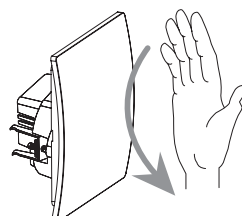
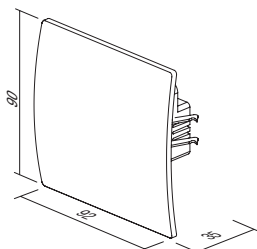
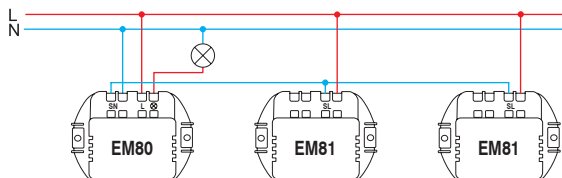
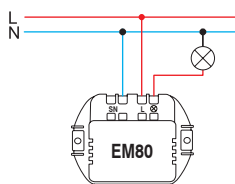

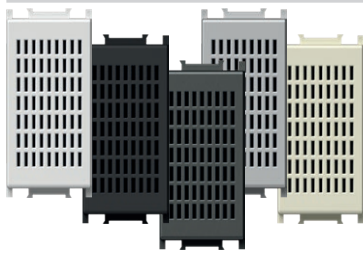

- EM91PW
- EM91SB
- EM91AT
- EM91ES
- EM91IW

ZVONO 8VA 12V~ 1M

- signalno zvono
- emisija zvuka traje vremenski jednako kao i postupak posluživanja
- mrežni napon 12V~ 50Hz 8VA

BUZZER 8VA 12V~1M

- signal buzzer
- the sound emission has the same lasting time as the control operation
- supply voltage 12V~ 50Hz 8VA

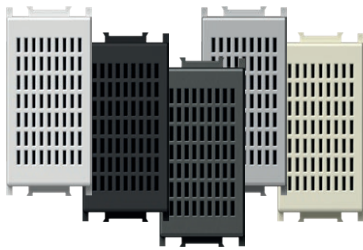

- EM93PW
- EM93SB
- EM93AT
- EM93ES
- EM93IW

ZVONO 8VA 12V~ 1M

- signalno zvono
- emisija zvuka traje vremenski jednako kao i postupak posluživanja
- mrežni napon 12V~ 50Hz 8VA

BELL 8VA 12V~1M

- signal bell
- the sound emission has the same lasting time as the control operation
- supply voltage 12V~ 50Hz 8VA

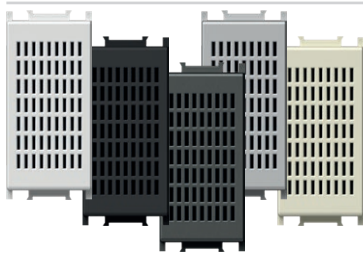

- EM94PW
- EM94SB
- EM94AT
- EM94ES
- EM94IW

ZVONO 230V~ 6mA rms 1M

- napajanje 230 V~ 50/60 Hz
- potrošnja kod melodije 1: 4,7 mA rms
- potrošnja kod melodije 2: 5,9 mA rms
- razina zvuka melodije 1: 90,5 dB
- razina zvuka melodije 2: 86 dB
- radna temperatura: 0 °C / 45 °C (unutarnja uporaba)
- temperatura skladištenja: -20 °C / 50 °C
- IP zaštitni razred: IP20 (samo za unutarnju uporabu)
- sigurnosni razred uređaja II
- prenaponska zaštita (EN 62109): klasa III
- vijčano pričvršćivanje vodiča maks. 2,5 mm²
- uređaj s razmakom kontakata min. 3 mm
- zvono mora biti zaštićeno odgovarajućim vanjskim osiguračem
- usklađeno s direktivama EMC i LVD

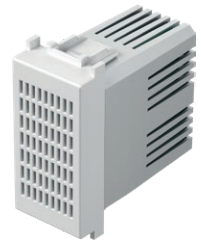

BELL 230V~ 6mA rms 1M

- power supply 230 V~ 50/60 Hz
- power consumption when playing melody 1: 4.7 mA rms
- power consumption when playing melody 2: 5.9 mA rms
- sound level of melody 1: 90.5 dB
- sound level of melody 2: 86 dB
- operating temperature 0°C/45°C (indoor use)
- storage temperature: -20°C / 50°C
- IP protection class: IP20 (indoor use only)
- class device II
- overvoltage category (EN62109): Class III
- screw contacts: max. 2.5 mm²
- device with a contact gap of at least 3 mm
- an easily accessible cut-off switch must be installed upstream from bell
- complies with EMC & LVD directives

EM91
EM93
EM94

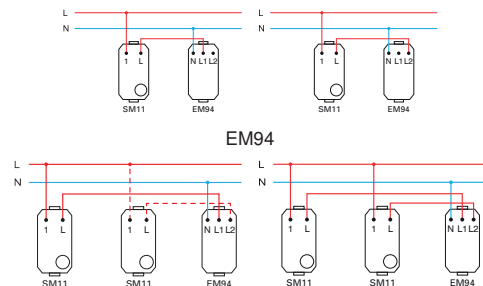
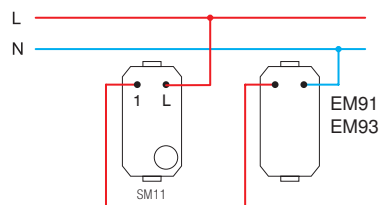
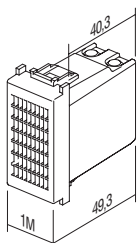

REGULATOR GLASNOĆE ZA 100V AUDIO LINIJU 35W 2M

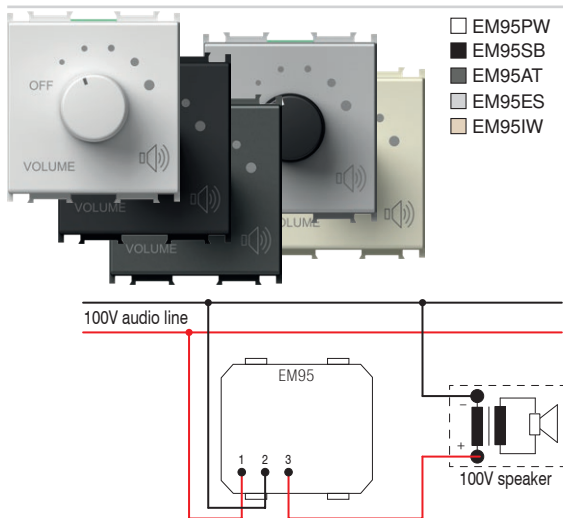

- regulator glasnoće (atenuator) za 100V audio sustave
- nazivna snaga 35W (maks.45W), 6 razina glasnoće
- prikladan za ugradnju u kutije najmanje 60 mm dubine
- nije prikladan za ugradnju u kutije dubine 45 mm te podžbuknu ugradnju u kutije CUBO IP20
- samo za unutrašnju uporabu



VOLUME CONTROL 100V AUDIO LINE 35W 2M

- volume control (attenuator) for 100V audio systems
- power rating 35W (max.45W), 6 steps volume control
- suitable for boxes min. 60 mm deep
- not suitable for installation in 45 mm deep boxes and surface mount boxes CUBO IP20
- for indoor use only

REGULATOR GLASNOĆE 4-8 Ω 35W 2M

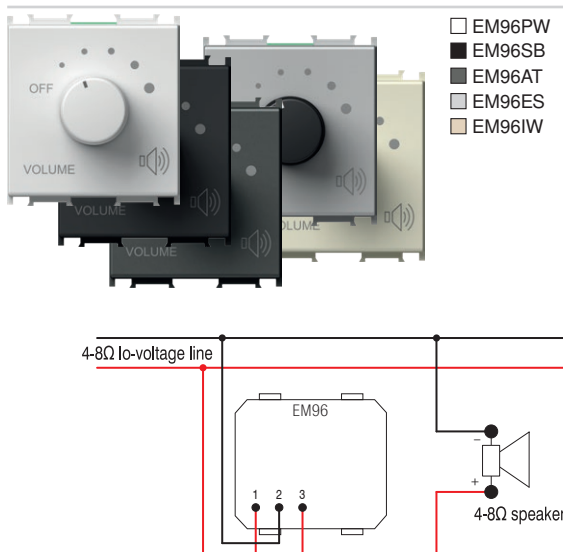

- regulator glasnoće za niskonaponske izlaze 4-8 Ω, 35W
- nazivna snaga 35W, 6 razina glasnoće
- prikladan za ugradnju u kutije najmanje 60 mm dubine
- nije prikladan za ugradnju u kutije dubine 45 mm te podžbuknu ugradnju u kutije CUBO IP20
- samo za unutrašnju uporabu



VOLUME CONTROL 4-8 Ω 35W 2M

- volume control (attenuator) for low voltage outputs 4-8 Ω, 35W
- power rating 35W, 6 steps volume control
- suitable for boxes min. 60 mm deep
- not suitable for installation in 45 mm deep boxes and surface mount boxes CUBO IP20
- for indoor use only

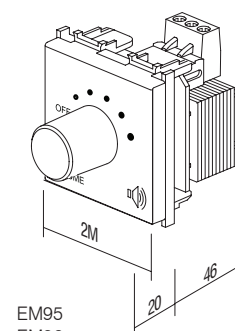

EM95
EM96



CM25

PW

OS

tip type	naziv description	tehnički podaci technical data	veličina size	boja colour	opcijski podaci 1 optional data 1
CM10	SET UTIČNICA 2X ŠUKO SOCKET SET 2x SCHUKO	2P+E 16A 250V~	4M	<input type="checkbox"/> PW bijela sjajna polar white	<input type="checkbox"/> OL okvir LINE cover plate LINE
CM11	SET UTIČNICA 3X ŠUKO SOCKET SET 3x SCHUKO	2P+E 16A 250V~	7M	<input checked="" type="checkbox"/> SB crna mat soft touch black	<input type="checkbox"/> OS okvir SOFT cover plate SOFT
CM15	SET SPOJNIH VODOVA LINK WIRE SET	3x1.5mm ²	1M	<input checked="" type="checkbox"/> AT antracit anthracite	
⋮	⋮	⋮	⋮	<input type="checkbox"/> ES srebrna mat elox silver	
⋮	⋮	⋮	⋮	<input type="checkbox"/> IW bež sjajna ivory white	

SET UTIČNICA 2x ŠUKO 2P+E 16A 250V~ 4M

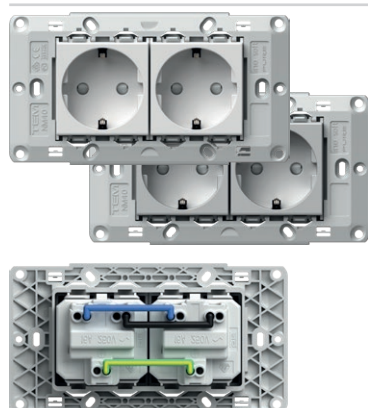

- CM10PW
 CM10ES

- set utičnica 2x šuko VM10 2P+E 16A 250V~
- utičnice povezane spojnim vodovima CM16
- s nosačem 4M bez vijaka
- za pričvršćivanje nosača vijci CM17, CM18 ili CM19
- vijčano pričvršćivanje vodiča presjeka 1,5-2,5 mm²
- sukladno normi IEC 60884-1, CEE7

SOCKETS SET 2x SCHUKO 2P+E 16A 250V~ 4M

- socket set 2x schuko VM10 2P+E 16A 250V~
- prewired with link wires CM16
- with mounting frame 4M without screws
- for mounting frame fixing use screws CM17, CM18 or CM19
- screw contacts 1.5-2.5 mm²
- in accordance with IEC-60884-1, CEE7

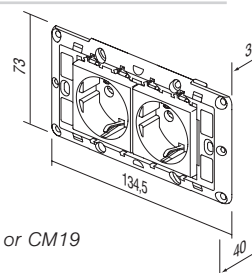

SET UTIČNICA 3x ŠUKO 2P+E 16A 250V~ 7M

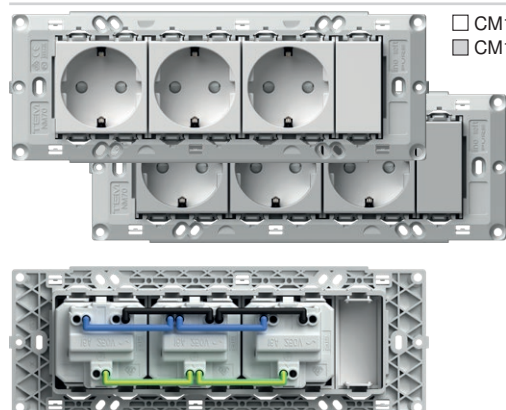

- CM11PW
 CM11ES

- set utičnica 3x šuko VM10 2P+E 16A 250V~
- utičnice povezane spojnim vodovima CM16
- s nosačem 7M bez vijaka
- za pričvršćivanje nosača vijci CM17, CM18 ili CM19
- vijčano pričvršćivanje vodiča presjeka 1,5-2,5 mm²
- sukladno normi IEC 60884-1, CEE7

SOCKETS SET 3x SCHUKO 2P+E
16A 250V~ 7M

- socket set 3x schuko VM10 2P+E 16A 250V~
- prewired with link wires CM16
- with mounting frame 7M without screws
- for mounting frame fixing use screws CM17, CM18 or CM19
- screw contacts 1.5-2.5 mm²
- in accordance with IEC-60884-1, CEE7

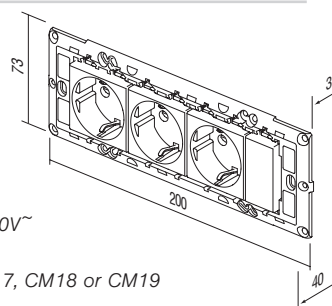

SET SPOJNIH VODOVA 3x1,5mm² 1M

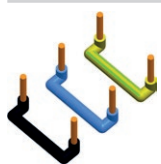

CM15

- set spojnih vodova za povezivanje dvaju elemenata veličine 1M
- sadrži 10 crnih, 10 plavih i 10 žuto-zelenih spojnih vodova

LINK WIRE SET 3x1.5mm² 1M

- link wire set to connect two elements size 1M
- includes 10 black, 10 blue and 10 yellow/green wires

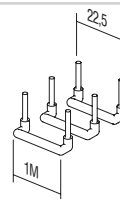

SET SPOJNIH VODOVA 3x2,5mm² 1M

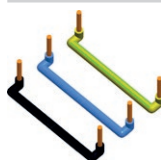

CM16

- set spojnih vodova za povezivanje dvaju elemenata veličine 2M
- sadrži 10 crnih, 10 plavih i 10 žuto-zelenih spojnih vodova

LINK WIRE SET 3x2.5mm² 2M

- link wire set to connect two elements size 2M
- includes 10 black, 10 blue and 10 yellow/green wires

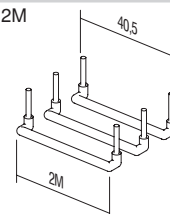

SET VIJAKA 3,5



CM17

CM18

CM19

- set vijaka za pričvršćivanje nosača NM30, NM32, NM40, NM41, NM70
- CM17 - l=20 mm, 100 kom.
- CM18 - l=35 mm, 50 kom.
- CM19 - l=50 mm, 50 kom.

SCREW SET 3,5

- screw set for fixing mounting frames NM30, NM32, NM40, NM41, NM70
- CM17 - l=20mm, 100pcs
- CM18 - l=35mm, 50pcs
- CM19 - l=50mm, 50pcs

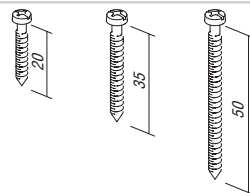

SET ZA SKLOPKE IP44 2M



- CM22PW
- CM22SB
- CM22AT
- CM22ES
- CM22IW

- za ugradnju u vlažne prostore
- IP44 zaštita za sve Modul sklopke
- sklopke i tipke nisu sastavni dio seta
- okvir SOFT 2M s natpisnom pločicom
- sukladno normi IEC 60669-1

SET SWITCHES IP44 2M

- for usage in humid areas
- IP44 protection provides for all Modul switches
- switches and buttons are not part of the set
- SOFT 2M cover plate with inscription plate
- in accordance with IEC 60669-1



SET ZA UTIČNICU IP44 2M



- CM23PW
- CM23SB
- CM23AT
- CM23ES
- CM23IW

- za ugradnju u vlažne prostore
- pruža IP44 zaštitu u kombinaciji s pokrivenom utičnicom (VM11, VM41)
- utičnice nisu sastavni dio seta
- okvir SOFT 2M s natpisnom pločicom
- sukladno normi IEC 60884-1

SET SOCKETS IP44 2M

- for usage in humid areas
- IP44 protection can be achieved only in combination with covered socket (VM11, VM41)
- sockets are not part of the set
- SOFT 2M cover plate with inscription plate
- in accordance with IEC 60884-1



KUPAONSKI SET 3x20A 250V~ 4M

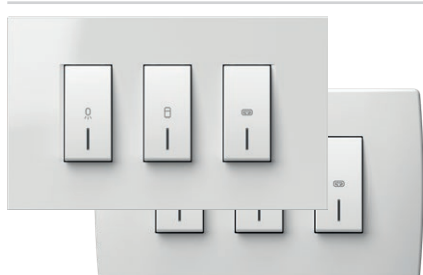

- CM25PWOL
- CM25IWOL
- CM25PWOS
- CM25IWOS

- set sklopki 3xSM12 20A 250V~ s nosačem i okvirom
- vijčano pričvršćivanje vodiča presjeka 1,5-2.5mm²
- sukladno normi EN 60669-1
- univerzalno rješenje za pričvršćivanje na već ugrađene kutije s razmakom pričvršćivanja od 108 do 135 mm ili na kutije veličine 4M
- visina okvira 90 mm

SWITCH SET FOR BATHROOM 3x20A 250V~ 4M

- switch set 3xSM12 20A 250V~ with mounting frame and cover plate
- screw contacts 1.5-2.5mm²
- in accordance with EN 60669-1
- universal solution for renovation on boxes with fixing dimensions 108-135mm or boxes 4M size
- cover plate height 90mm

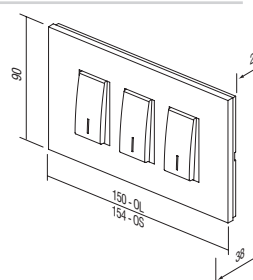

NOSAČI ZA KUPAONSKI SET 4M



NM41

- univerzalni nosač za kupaonski set s vijcima
- univerzalno rješenje za pričvršćivanje na pravokutne kutije s razmakom pričvršćivanja od 108 do 135 mm ili na kutije veličine 4M
- sukladno normi EN 60669-1

MOUNTING FRAME BATHROOM SET 4M

- universal mounting frame for bathroom set with screws
- universal solution for mounting on rectangular boxes with fixing dimensions 108-135mm or boxes 4M size
- in accordance with EN 60669-1

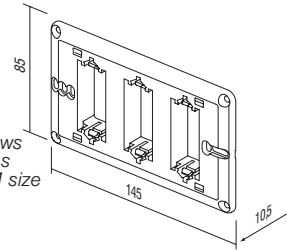

OKVIRI LINE ZA KUPAONSKI SET



	OL41PW		OL41NB
	OL41NB		OL41IW
	OL41IW		OL41ES
	OL41ES		OL41SG
	OL41SG		OL41IB
	OL41IB		OL41AT
	OL41AT		OL41TI
	OL41TI		OL41SB
	OL41SB		

- dekorativni okvir LINE za kupaonski set
- visina 90 mm
- sukladno normi EN 60669-1

COVER PLATE LINE BATHROOM SET

- decorative cover plate bathroom set LINE
- height 90mm
- in accordance with EN 60669-1

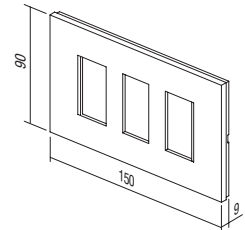

OKVIRI SOFT ZA KUPAONSKI SET



	OS41PW		OS41SB
	OS41NB		OS41WE
	OS41IW		OS41AT
	OS41ES		OS41TI
	OS41SG		

- dekorativni okvir SOFT za kupaonski set
- visina 90 mm
- sukladno normi EN 60669-1

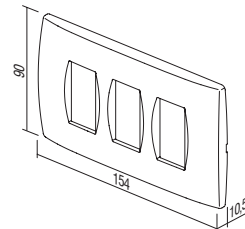

COVER PLATE SOFT BATHROOM SET

- decorative cover plate bathroom set SOFT
- height 90mm
- in accordance with EN 60669-1



ANTIBAKTERIJSKI PROGRAM MODUL



tip type	naziv description	veličina size	boja colour	opcijski podaci 1 optional data 1
TM11	TIPKA BUTTON	1M	<input type="checkbox"/> AW antibakterijska bijela antibacterial white	 NT neutralna neutral
TM21	SLIJEPI ELEMENT BLANK	1M		
VM10	UTIČNICA SOCKET	2M		 IN indikator indicator
.	.	.		
.	.	.		

ANTIBAKTERIJSKI PROGRAM MODUL

- brojne osobe svakodnevno dotiču sklopke i utičnice koje su stoga mjesta razvoja i širenja bakterija
- zahvaljujući prirodnim antibakterijskim svojstvima, srebro se tri tisuće godina koristi kao sigurno dezinfekcijsko sredstvo, jer je potpuno prirodan i neškodljiv materijal te ne zagađuje okoliš
- posebni antibakterijski ioni srebra pružaju dugotrajnu, pouzdanu i učinkovitu zaštitu od razvoja i širenja bakterija, mikroba i gljivica
- antibakterijska zaštita osigurava kvalitetnu higijenu, čistoću i zdravlje ljudima
- savršeno prikladan za korištenje u okruženjima koja zahtijevaju stroge higijenske uvjete (bolnice, zdravstveni centri, farmaceutska postrojenja, domovi za starije i nemoćne, domovi umirovljenika, laboratoriji, restorani, hoteli, zračne luke, autobuse i željezničke postaje, poslovni i trgovački prostori, javne institucije...)
- neovisni laboratoriji obavili su testiranja sukladno najvišim japanskim standardima JIS Z 2801
- niski troškovi osiguravanja ljudskog zdravlja
- dizajn i funkcionalnost antibakterijskog programa MODUL omogućava jednostavno čišćenje i održavanje
- antibakterijske tipke, okviri i utičnice kombinirani su sa standardnim ugradbenim okvirima i sklopkama
- proizvodi su označeni sa stražnje strane kao AB (antibakterijska bijela)

ANTIBACTERIAL PROGRAM MODUL

- switches and sockets are daily touched by many people, so this is a common place for development and spread of bacteria
- thanks to its natural antibacterial characteristics silver has been used for three millennia as a safe and effective disinfectant, since it is completely natural, healthy and environmentally friendly
- special antibacterial silver ions additive provides long-term, reliable and effective protection against the development and spread of bacteria, microbes and fungi
- antibacterial protection ensures hygiene, cleanliness and health for people
- perfectly suitable for use in environments with strict hygiene conditions (hospitals, health centers, pharmaceutical facilities, homes for elderly, nursing homes, laboratories, restaurants, hotels, airports, bus and railway stations, business and shopping areas, public institutions ...)
- independent laboratory testings have been carried out in accordance with highest Japanese standards JIS Z 2801
- low cost for providing human health
- design and functionality of antibacterial program MODUL allow easy cleaning and maintenance
- antibacterial buttons, cover plates and sockets are combined with classic mounting frames and switches
- products are labelled on the back with AW (antibacterial white)

ANTIBACTERIAL PROGRAM MODUL

	□ TM11AW	TIPKA 1M - zamjenjiva tipka 1M - sukladno normi EN 60669-1 - antibakterijska zaštita usklađena s JIS Z 2801	
	□ TM11AWIN	TIPKA 1M INDIKATOR - zamjenjiva tipka 1M - sukladno normi EN 60669-1 - antibakterijska zaštita usklađena s JIS Z 2801	
	□ TM12AW	TIPKA 2M - zamjenjiva tipka 2M s nosačem tipke - upotrebljava se pri nadogradnji sklopke ili tipkala od veličine 1M na veličinu 2M - sukladno normi EN 60669-1 - antibakterijska zaštita usklađena s JIS Z 2801	
	□ TM12AWIN	TIPKA 2M INDIKATOR - zamjenjiva tipka 2M s nosačem tipke - upotrebljava se pri nadogradnji sklopke ili tipkala od veličine 1M na veličinu 2M - sukladno normi EN 60669-1 - antibakterijska zaštita usklađena s JIS Z 2801	
	□ TM21AW	SLIJEPI ELEMENT 1M - slijepi element za popunjavanje praznog mjesta - sukladno normi EN 60669-1 - antibakterijska zaštita usklađena s JIS Z 2801	
	□ TM22AW	SLIJEPI ELEMENT 2M - slijepi element za popunjavanje praznog mjesta - sukladno normi EN 60669-1 - antibakterijska zaštita usklađena s JIS Z 2801	



□ VM10AW

UTIČNICA ŠUKO+KS 2P+E 16A 250V~ 2M

- 2P+E šuko
- 16A 250V~, tip VM10
- sukladno normama IEC 60884-1, CEE7
- vijčano pričvršćivanje vodiča presjeka 1,5-2,5 mm²
- utičnica s integriranom zaštitom
- antibakterijska zaštita usklađena s JIS Z 2801

SOCKET SCHUKO+KS 2P+E 16A 250V~ 2M

- 2P+E schuko
- 16A 250V~, type VM10
- in accordance with IEC 60884-1, CEE7
- screw contacts 1.5-2.5 mm²
- shuttered live contacts
- antibacterial protection in accordance with JIS Z 2801



□ VM11AW

UTIČNICA ŠUKO+KS +POKLOPAC 2P+E 16A 250V~ 2M

- 2P+E šuko+poklopac
- 16A 250V~, tip VM11
- sukladno normama IEC 60884-1, CEE7
- vijčano pričvršćivanje vodiča presjeka 1,5-2,5 mm²
- utičnica s integriranom zaštitom
- antibakterijska zaštita usklađena s JIS Z 2801

SOCKET SCHUKO+KS+COVER

- 2P+E 16A 250V~ 2M
- 2P+E schuko+cover
- 16A 250V~, type VM11
- in accordance with IEC 60884-1, CEE7
- screw contacts 1.5-2.5 mm²
- shuttered live contacts
- antibacterial protection in accordance with JIS Z 2801



□ VM20AW

UTIČNICA EURO+KS 2P 10A 250V~ 1M

- 2P Euro
- 10A 250V~, tip VM20
- sukladno normama IEC 60884-1, CEE7
- vijčano pričvršćivanje vodiča presjeka 1,5-2,5 mm²
- utičnica s integriranom zaštitom
- antibakterijska zaštita usklađena s JIS Z 2801

SOCKET EURO+KS 2P 10A 250V~ 1M

- 2P Euro
- 10A 250V~, type VM20
- in accordance with IEC 60884-1, CEE7
- screw contacts 1.5-2.5 mm²
- shuttered live contacts
- antibacterial protection in accordance with JIS Z 2801



□ KM11AW

UTIČNICA TV ZAVRŠNA 1dB 1M

- TV završna
- propušta frekvenciju u rasponu 5÷2400 MHz
- prigušenje < 1 dB
- sukladno normi EN 50083-1
- vijčano pričvršćivanje
- antibakterijska zaštita usklađena s JIS Z 2801

SOCKET TV END-LINE 1dB 1M

- TV end-line
- frequency range 5÷2400 MHz
- reduction < 1 dB
- in accordance with EN 50083-1
- screw contacts
- antibacterial protection in accordance with JIS Z 2801

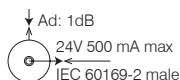

□ KM35AW

ADAPTER KS 1M

- KS keystone standard pričvršćivanja
- AMP, Avaya, Brandrex, FMT, Mfico, Tyco, ...
- nije ugraben komunikacijski modul
- antibakterijska zaštita usklađena s JIS Z 2801

ADAPTER KS 1M

- KS keystone fixing standard
- AMP, Avaya, Brandrex, FMT, Mfico, Tyco, ...
- communication module not included
- antibacterial protection in accordance with JIS Z 2801

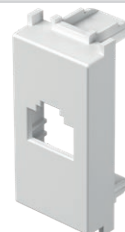

A N T I B A C T E R I A L P R O G R A M M O D U L



OS20AW

OKVIR SOFT 2M

- dekorativni okvir SOFT 2M
- skladno normi EN 60669-1
- antibakterijska zaščita uskladenjena s JIS Z 2801

COVER PLATE SOFT 2M

- decorative cover plate SOFT 2M
- in accordance with EN 60669-1
- antibacterial protection in accordance with JIS Z 2801



OS24AW

OKVIR SOFT 2x2M

- dekorativni okvir SOFT 2x2M
- vodoravna ili okomita ugradnja
- skladno normi EN 60669-1
- antibakterijska zaščita uskladenjena s JIS Z 2801

COVER PLATE SOFT 2x2M

- decorative cover plate SOFT 2x2M
- horizontal or vertical mounting
- in accordance with EN 60669-1
- antibacterial protection in accordance with JIS Z 2801



OS26AW

OKVIR SOFT 3x2M

- dekorativni okvir SOFT 3x2M
- vodoravna ili okomita ugradnja
- skladno normi EN 60669-1
- antibakterijska zaščita uskladenjena s JIS Z 2801

COVER PLATE SOFT 3x2M

- decorative cover plate SOFT 3x2M
- horizontal or vertical mounting
- in accordance with EN 60669-1
- antibacterial protection in accordance with JIS Z 2801



OS30AW

OKVIR SOFT 3M

- dekorativni okvir SOFT 3M
- antibakterijska zaščita uskladenjena s JIS Z 2801
- skladno normi EN 60669-1

COVER PLATE SOFT 3M

- decorative cover plate SOFT 3M
- in accordance with EN 60669-1
- antibacterial protection in accordance with JIS Z 2801



OS40AW

OKVIR SOFT 4M

- dekorativni okvir SOFT 4M
- skladno normi EN 60669-1
- antibakterijska zaščita uskladenjena s JIS Z 2801

COVER PLATE SOFT 4M

- decorative cover plate SOFT 4M
- in accordance with EN 60669-1
- antibacterial protection in accordance with JIS Z 2801

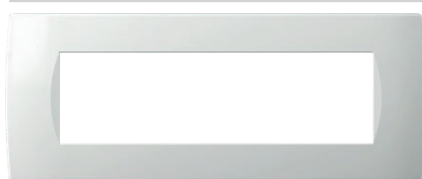

OS70AW

OKVIR SOFT 7M

- dekorativni okvir SOFT 7M
- skladno normi EN 60669-1
- antibakterijska zaščita uskladenjena s JIS Z 2801

COVER PLATE SOFT 7M

- decorative cover plate SOFT 7M
- in accordance with EN 60669-1
- antibacterial protection in accordance with JIS Z 2801

drvo
wood

WB bambus
bamboo



WW orah
walnut

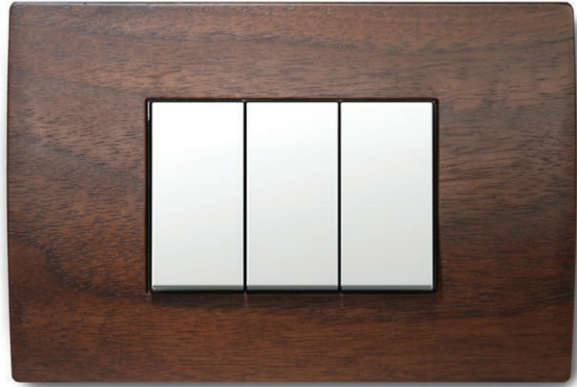

WM javor
maple



WE wenge
wenge

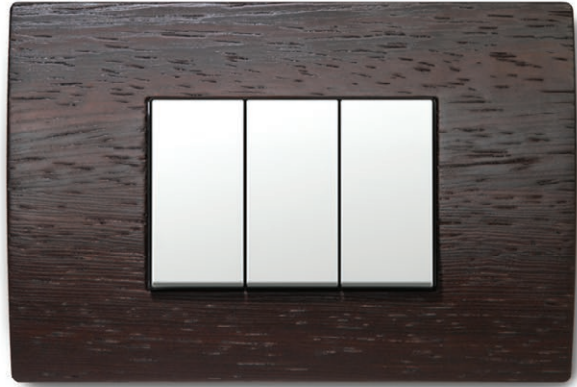

Priroda je jedinstvena i dragocjena, baš kao i naši okviri, među kojima ne postoje dva ista.
Reklamacije zbog različitosti izgleda i međusobne raznolikosti drvenih okvira ne uvažavamo.

Nature is unique and precious, as our decorative cover plates where no two are the same.
Complaints about wooden decorative cover plate's diverse appearance and differentiation cannot be considered.

MODUL

PURE

COVER PLATES PURE OP

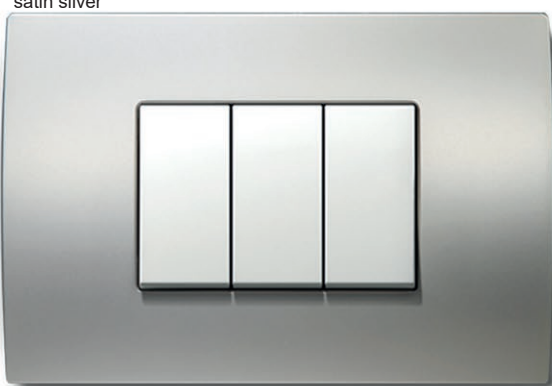
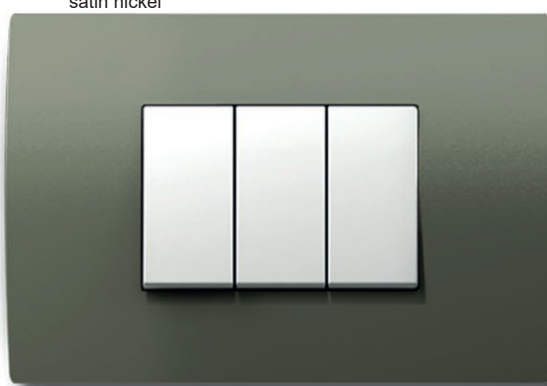
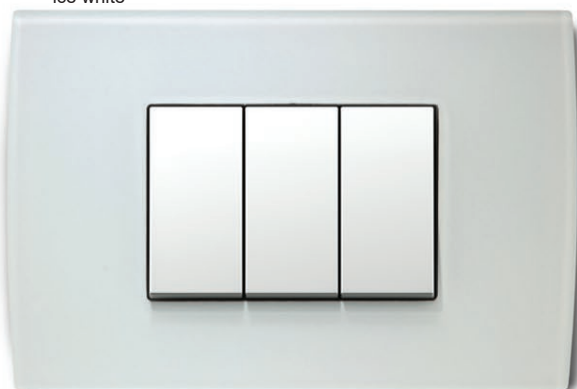
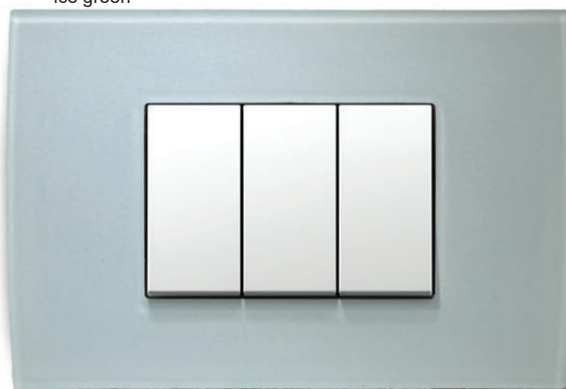
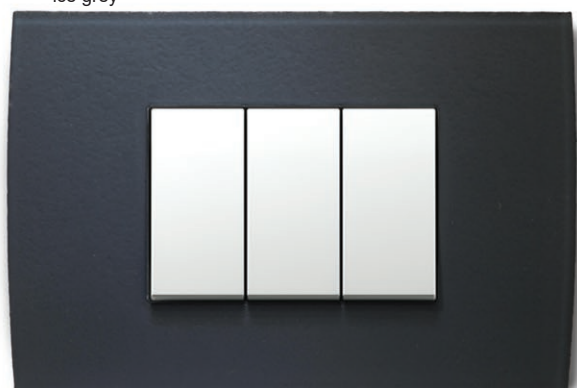
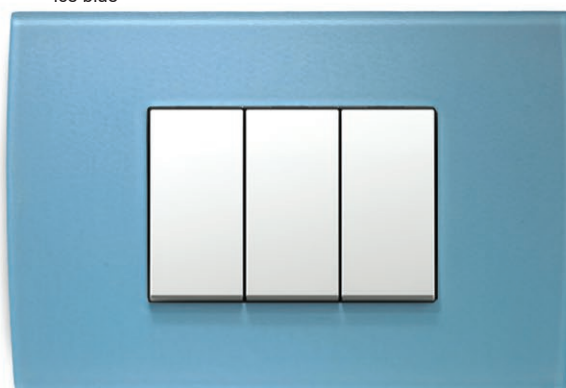
metal
metalMH kovani čelik
hammered steelME lijevano željezo
etched ironMS satenski srebrna
satin silverMN satenski poniklani
satin nickelstaklo
glassGW ledeno bijela
ice whiteGG ledeno zelena
ice greenGY ledeno siva
ice greyGB ledeno plava
ice blue

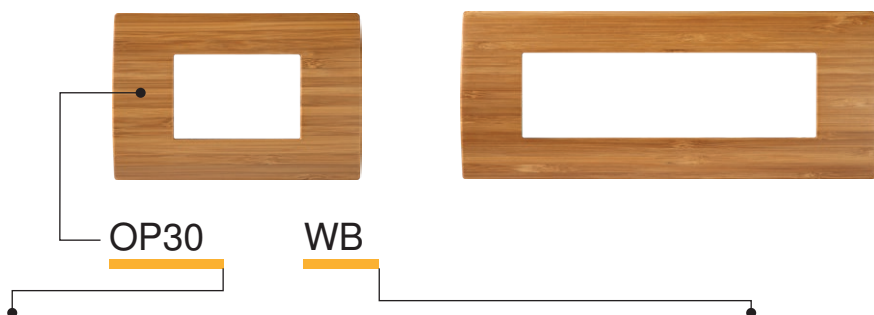

tip type	naziv description	veličina size	boja colour
OP13	OKVIR PURE COVER PLATE PURE	1/3M	MH kovani čelik hammered steel WB bambus bamboo
OP20	OKVIR PURE COVER PLATE PURE	2M	ME lijevano željezo etched iron WW orah walnut
OP23	OKVIR PURE COVER PLATE PURE	2/3M	MS satenski srebrna satin silver WM javor maple
.	.	.	MN satenski poniklani satin nickel WE wenge wenge
.	.	.	GW ledeno bijela ice white GG ledeno zelena ice green
.	.	.	GY ledeno siva ice grey GB ledeno plava ice blue

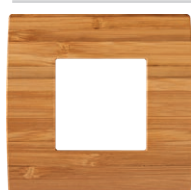

MH	OP20MH	WB	OP20WB
ME	OP20ME	WW	OP20WW
MS	OP20MS	WM	OP20WM
MN	OP20MN	WE	OP20WE
		GW	OP20GW
		GG	OP20GG
		GY	OP20GY
		GB	OP20GB

OKVIR PURE 2M

- dekorativni okvir PURE 2M
- sukladno normi EN 60669-1
- samo u kombinaciji s nosačem NM24 ili NM25

COVER PLATE PURE 2M

- decorative cover plate PURE 2M
- in accordance with EN 60669-1
- only in combination with mounting frame NM24 or NM25

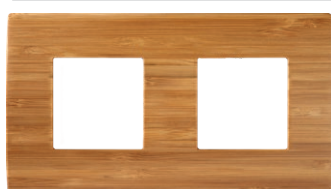

MH	OP24MH	WB	OP24WB
ME	OP24ME	WW	OP24WW
MS	OP24MS	WM	OP24WM
MN	OP24MN	WE	OP24WE
		GW	OP24GW
		GG	OP24GG
		GY	OP24GY
		GB	OP24GB

OKVIR PURE 2x2M

- dekorativni okvir PURE 2x2M
- vodoravna ili okomita ugradnja
- sukladno normi EN 60669-1
- samo u kombinaciji s nosačem NM24 ili NM25

COVER PLATE PURE 2x2M

- decorative cover plate PURE 2x2M
- horizontal or vertical mounting
- in accordance with EN 60669-1
- only in combination with mounting frames NM24 or NM25



MH	OP26MH	WB	OP26WB
ME	OP26ME	WW	OP26WW
MS	OP26MS	WM	OP26WM
MN	OP26MN	WE	OP26WE
		GW	OP26GW
		GG	OP26GG
		GY	OP26GY
		GB	OP26GB

OKVIR PURE 3x2M

- dekorativni okvir PURE 3x2M
- vodoravna ili okomita ugradnja
- sukladno normi EN 60669-1
- samo u kombinaciji s nosačem NM24 ili NM25

COVER PLATE PURE 3x2M

- decorative cover plate PURE 3x2M
- horizontal or vertical mounting
- in accordance with EN 60669-1
- only in combination with mounting frames NM24 or NM25



MH	OP28MH	WB	OP28WB
ME	OP28ME	WW	OP28WW
MS	OP28MS	WM	OP28WM
MN	OP28MN	WE	OP28WE
		GW	OP28GW
		GG	OP28GG
		GY	OP28GY
		GB	OP28GB

OKVIR PURE 4x2M

- dekorativni okvir PURE 4x2M
- vodoravna ili okomita ugradnja
- sukladno normi EN 60669-1
- samo u kombinaciji s nosačem NM24 ili NM25

COVER PLATE PURE 4x2M

- decorative cover plate PURE 4x2M
- horizontal or vertical mounting
- in accordance with EN 60669-1
- only in combination with mounting frames NM24 or NM25

COVER PLATES PURE OP

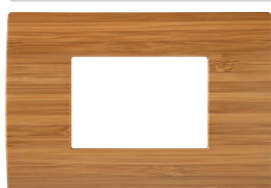

	OP30MH		OP30WB
	OP30ME		OP30WW
	OP30MS		OP30WM
	OP30MN		OP30WE
			OP30GW
			OP30GG
			OP30GY
			OP30GB

OKVIR PURE 3M

- dekorativni okvir PURE 3M
- skladno normi EN 60669-1

COVER PLATE PURE 3M

- decorative cover plate PURE 3M
- in accordance with EN 60669-1



	OP40MH		OP40WB
	OP40ME		OP40WW
	OP40MS		OP40WM
	OP40MN		OP40WE
			OP40GW
			OP40GG
			OP40GY
			OP40GB

OKVIR PURE 4M

- dekorativni okvir PURE 4M
- skladno normi EN 60669-1

COVER PLATE PURE 4M

- decorative cover plate PURE 4M
- in accordance with EN 60669-1



	OP70MH		OP70WB
	OP70ME		OP70WW
	OP70MS		OP70WM
	OP70MN		OP70WE
			OP70GW
			OP70GG
			OP70GY
			OP70GB

OKVIR PURE 7M

- dekorativni okvir PURE 7M
- skladno normi EN 60669-1

COVER PLATE PURE 7M

- decorative cover plate PURE 7M
- in accordance with EN 60669-1



	OP13MH		OP13WB
	OP13ME		OP13WW
	OP13MS		OP13WM
	OP13MN		OP13WE
			OP13GW
			OP13GG
			OP13GY
			OP13GB

OKVIR PURE 1/3M

- dekorativni okvir PURE 1/3M
- skladno normi EN 60669-1

COVER PLATE PURE 1/3M

- decorative cover plate PURE 1/3M
- in accordance with EN 60669-1



	OP23MH		OP23WB
	OP23ME		OP23WW
	OP23MS		OP23WM
	OP23MN		OP23WE
			OP23GW
			OP23GG
			OP23GY
			OP23GB

OKVIR PURE 2/3M

- dekorativni okvir PURE 2/3M
- skladno normi EN 60669-1

COVER PLATE PURE 2/3M

- decorative cover plate PURE 2/3M
- in accordance with EN 60669-1

osnovni
basic

PW bijela sjajna
polar white

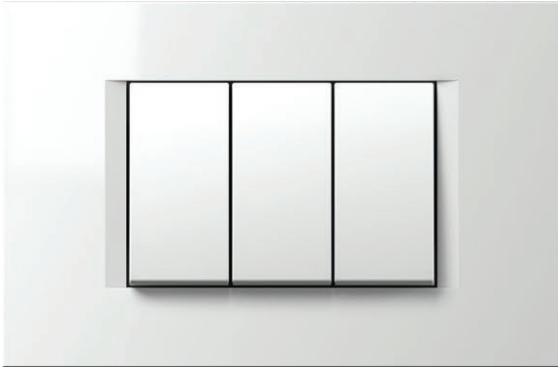

IW bež sjajna
ivory white

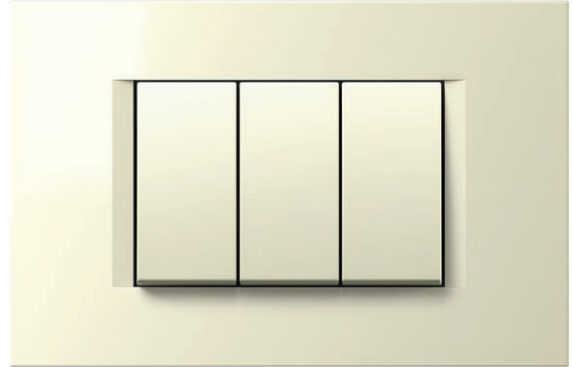

ES srebrna mat
elox silver



SB crna mat
soft touch black

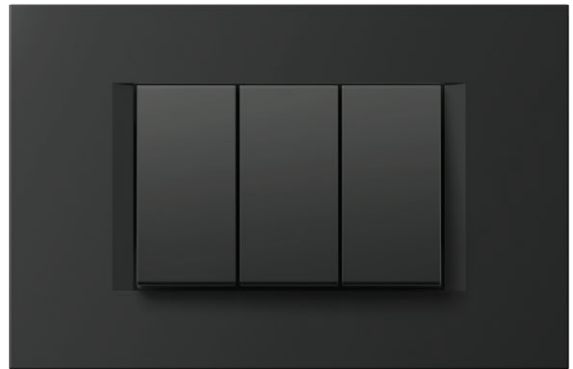

AT antracit
anthracite

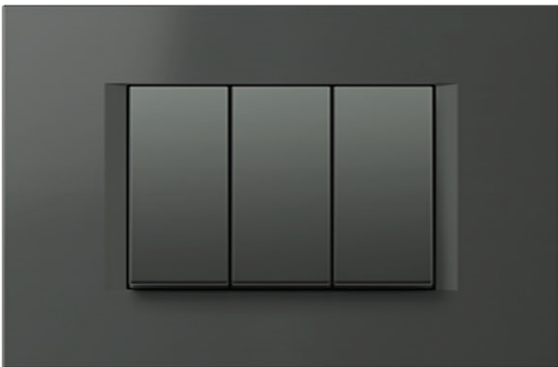

COVER PLATES LINE OL

dekor
decor

SG zlatna mat
sand gold

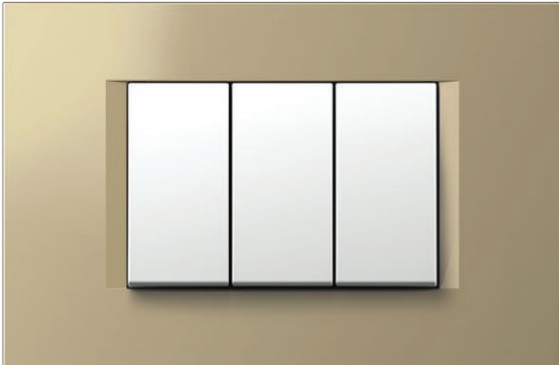

NB crna sjajna
night black

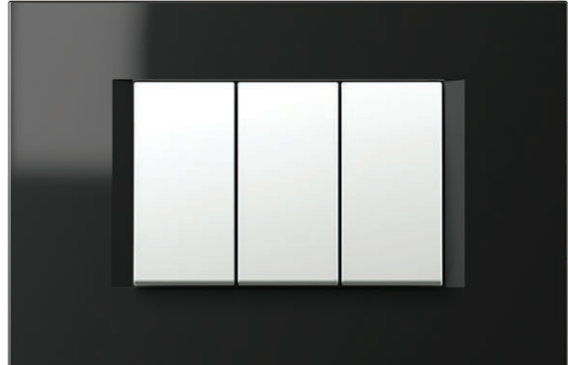

IB plava mat
impulse blue

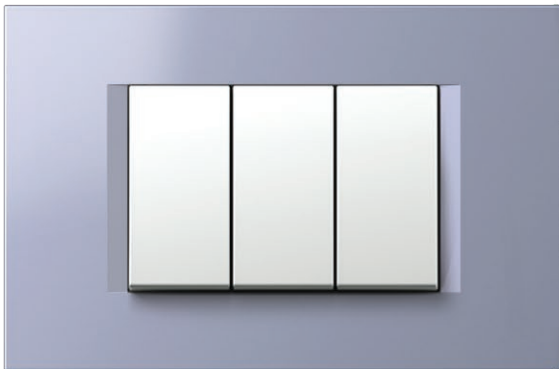

TI titan
titanium



SW kamen bijeli
stone white



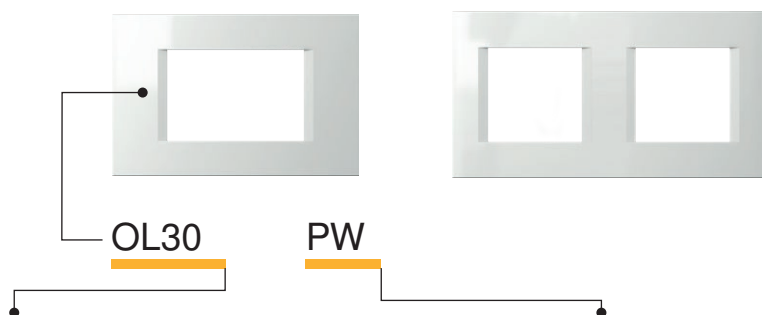

tip type	naziv description	veličina size	boja colour																		
OL10	OKVIR LINE COVER PLATE LINE	1/2M	<table border="0"> <tr> <td></td> <td>PW</td> <td>bijela sjajna polar white</td> <td></td> <td>SG</td> <td>zlatna mat sand gold</td> <td></td> <td>AT</td> <td>antracit anthracite</td> </tr> </table>		PW	bijela sjajna polar white		SG	zlatna mat sand gold		AT	antracit anthracite									
	PW	bijela sjajna polar white		SG	zlatna mat sand gold		AT	antracit anthracite													
OL13	OKVIR LINE COVER PLATE LINE	1/3M	<table border="0"> <tr> <td></td> <td>IW</td> <td>bež sjajna ivory white</td> <td></td> <td>NB</td> <td>crna sjajna night black</td> <td></td> <td>TI</td> <td>titan titanium</td> </tr> </table>		IW	bež sjajna ivory white		NB	crna sjajna night black		TI	titan titanium									
	IW	bež sjajna ivory white		NB	crna sjajna night black		TI	titan titanium													
OL20	OKVIR LINE COVER PLATE LINE	2M	<table border="0"> <tr> <td></td> <td>ES</td> <td>srebrna mat elox silver</td> <td></td> <td>IB</td> <td>plava mat impulse blue</td> <td></td> <td>SW</td> <td>kamen bijeli stone white</td> </tr> <tr> <td></td> <td>SB</td> <td>crna mat soft touch black</td> <td></td> <td></td> <td></td> <td></td> <td></td> <td></td> </tr> </table>		ES	srebrna mat elox silver		IB	plava mat impulse blue		SW	kamen bijeli stone white		SB	crna mat soft touch black						
	ES	srebrna mat elox silver		IB	plava mat impulse blue		SW	kamen bijeli stone white													
	SB	crna mat soft touch black																			



	OL20PW		OL20SG
	OL20IW		OL20NB
	OL20ES		OL20IB
	OL20SB		OL20AT
			OL20TI
			OL20SW

OKVIR LINE 2M

- dekorativni okvir LINE 2M
- sukladno normi EN 60669-1

COVER PLATE LINE 2M

- decorative cover plate LINE 2M
- in accordance with EN 60669-1

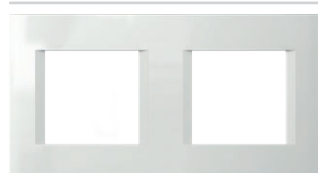

	OL24PW		OL24SG
	OL24IW		OL24NB
	OL24ES		OL24IB
	OL24SB		OL24AT
			OL24TI
			OL24SW

OKVIR LINE 2x2M

- dekorativni okvir LINE 2x2M
- vodoravna ili okomita ugradnja
- sukladno normi EN 60669-1

COVER PLATE LINE 2x2M

- decorative cover plate LINE 2x2M
- horizontal or vertical mounting
- in accordance with EN 60669-1

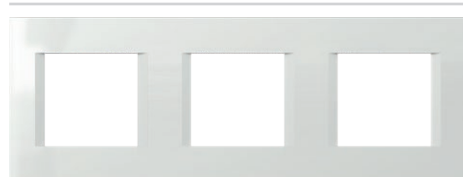

	OL26PW		OL26SG
	OL26IW		OL26NB
	OL26ES		OL26IB
	OL26SB		OL26AT
			OL26TI
			OL26SW

OKVIR LINE 3x2M

- dekorativni okvir LINE 3x2M
- vodoravna ili okomita ugradnja
- sukladno normi EN 60669-1

COVER PLATE LINE 3x2M

- decorative cover plate LINE 3x2M
- horizontal or vertical mounting
- in accordance with EN 60669-1



	OL28PW		OL28SG
	OL28IW		OL28NB
	OL28ES		OL28IB
	OL28SB		OL28AT
			OL28TI
			OL28SW

OKVIR LINE 4x2M

- dekorativni okvir LINE 4x2M
- vodoravna ili okomita ugradnja
- sukladno normi EN 60669-1

COVER PLATE LINE 4x2M

- decorative cover plate LINE 4x2M
- horizontal or vertical mounting
- in accordance with EN 60669-1



	OL29PW
	OL29IW
	OL29ES
	OL29SB
	OL29AT
	OL29TI

OKVIR LINE 5x2M











- dekorativni okvir LINE 5x2M
- vodoravna ili okomita ugradnja
- sukladno normi EN 60669-1

COVER PLATE LINE 5x2M

- decorative cover plate LINE 5x2M
- horizontal or vertical mounting
- in accordance with EN 60669-1

COVER PLATES LINE OL













 OL30PW	 OL30SG
 OL30IW	 OL30NB
 OL30ES	 OL30IB
 OL30SB	 OL30AT
	 OL30TI
	 OL30SW

OKVIR LINE 3M

- dekorativni okvir LINE 3M
- skladno normi EN 60669-1

COVER PLATE LINE 3M
- decorative cover plate LINE 3M
- in accordance with EN 60669-1











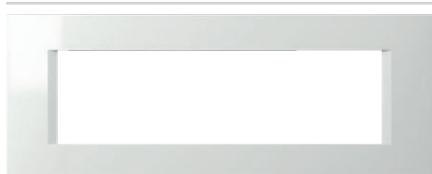

 OL40PW	 OL40SG
 OL40IW	 OL40NB
 OL40ES	 OL40IB
 OL40SB	 OL40AT
	 OL40TI
	 OL40SW

OKVIR LINE 4M

- dekorativni okvir LINE 4M
- skladno normi EN 60669-1

COVER PLATE LINE 4M
- decorative cover plate LINE 4M
- in accordance with EN 60669-1













 OL70PW	 OL70SG
 OL70IW	 OL70NB
 OL70ES	 OL70IB
 OL70SB	 OL70AT
	 OL70TI
	 OL70SW

OKVIR LINE 7M

- dekorativni okvir LINE 7M
- skladno normi EN 60669-1

COVER PLATE LINE 7M
- decorative cover plate LINE 7M
- in accordance with EN 60669-1











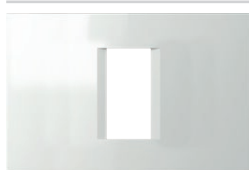

 OL10PW	 OL10SG
 OL10IW	 OL10NB
 OL10ES	 OL10IB
 OL10SB	 OL10AT
	 OL10TI
	 OL10SW

OKVIR LINE 1/2M

- dekorativni okvir LINE 1/2M
- skladno normi EN 60669-1

COVER PLATE LINE 1/2M
- decorative cover plate LINE 1/2M
- in accordance with EN 60669-1













 OL13PW	 OL13SG
 OL13IW	 OL13NB
 OL13ES	 OL13IB
 OL13SB	 OL13AT
	 OL13TI
	 OL13SW

OKVIR LINE 1/3M

- dekorativni okvir LINE 1/3M
- skladno normi EN 60669-1

COVER PLATE LINE 1/3M
- decorative cover plate LINE 1/3M
- in accordance with EN 60669-1



 OL23PW	 OL23SG
 OL23IW	 OL23NB
 OL23ES	 OL23IB
 OL23SB	 OL23AT
	 OL23TI
	 OL23SW

OKVIR LINE 2/3M

- dekorativni okvir LINE 2/3M
- skladno normi EN 60669-1

COVER PLATE LINE 2/3M
- decorative cover plate LINE 2/3M
- in accordance with EN 60669-1

osnovni
basic

PW bijela sjajna
polar white

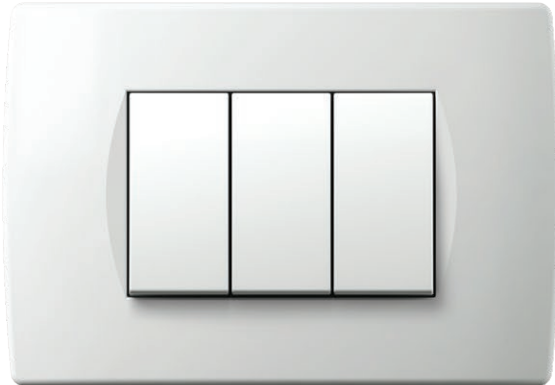

IW bež sjajna
ivory white

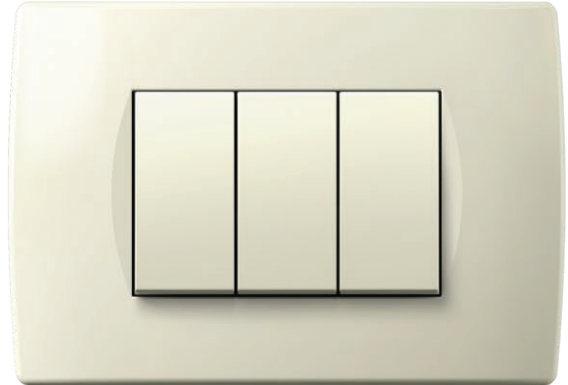

ES srebrna mat
elox silver

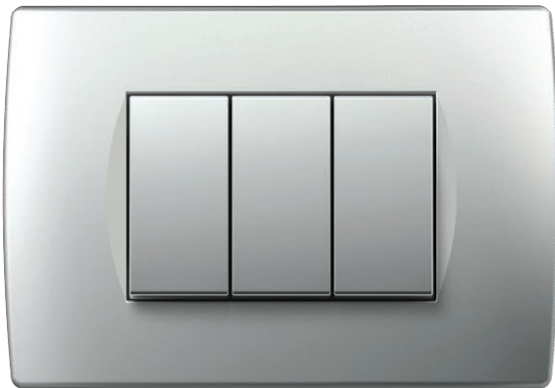

SB crna mat
soft touch black



AT antracit
anthracite

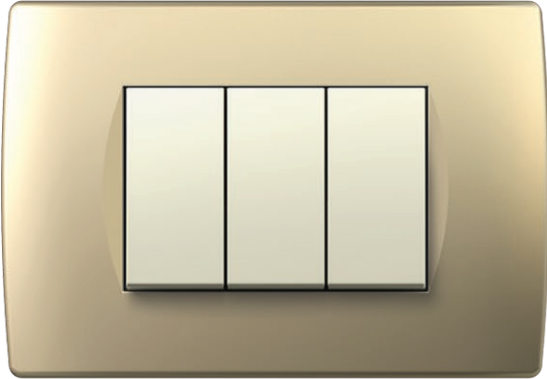
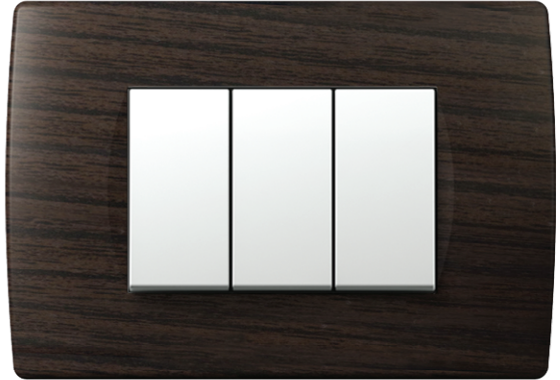

COVER PLATES SOFT OS

dekor
decorSG zlatna mat
sand goldNB crna sjajna
night blackTI titan
titaniumWE wenge
wengeWW orah
walnut



OS30

PW

tip type	naziv description	veličina size	boja colour												
OS10	OKVIR SOFT COVER PLATE SOFT	1/2M	<table border="0"> <tr> <td></td> <td>PW bijela sjajna polar white</td> <td></td> <td>SG zlatna mat sand gold</td> <td></td> <td>WW orah walnut</td> </tr> </table>		PW bijela sjajna polar white		SG zlatna mat sand gold		WW orah walnut						
	PW bijela sjajna polar white		SG zlatna mat sand gold		WW orah walnut										
OS13	OKVIR SOFT COVER PLATE SOFT	1/3M	<table border="0"> <tr> <td></td> <td>IW bež sjajna ivory white</td> <td></td> <td>NB crna sjajna night black</td> <td></td> <td>WE wenge wenge</td> </tr> </table>		IW bež sjajna ivory white		NB crna sjajna night black		WE wenge wenge						
	IW bež sjajna ivory white		NB crna sjajna night black		WE wenge wenge										
OS20	OKVIR SOFT COVER PLATE SOFT	2M	<table border="0"> <tr> <td></td> <td>ES srebrna mat elox silver</td> <td></td> <td>AT antracit anthracite</td> <td></td> <td></td> </tr> <tr> <td></td> <td>SB crna mat soft touch black</td> <td></td> <td>TI titan titanium</td> <td></td> <td></td> </tr> </table>		ES srebrna mat elox silver		AT antracit anthracite				SB crna mat soft touch black		TI titan titanium		
	ES srebrna mat elox silver		AT antracit anthracite												
	SB crna mat soft touch black		TI titan titanium												
.	.	.	.												
.	.	.	.												



	OS20PW		OS20SG
	OS20IW		OS20NB
	OS20ES		OS20AT
	OS20SB		OS20TI
			OS20WW
			OS20WE

OKVIR SOFT 2M

- dekorativni okvir SOFT 2M
- sukladno normi EN 60669-1

COVER PLATE SOFT 2M

- decorative cover plate SOFT 2M
- in accordance with EN 60669-1



	OS24PW		OS24SG
	OS24IW		OS24NB
	OS24ES		OS24AT
	OS24SB		OS24TI
			OS24WW
			OS24WE

OKVIR SOFT 2x2M

- dekorativni okvir SOFT 2x2M
- vodoravna ili okomita ugradnja
- sukladno normi EN 60669-1

COVER PLATE SOFT 2x2M

- decorative cover plate SOFT 2x2M
- horizontal or vertical mounting
- in accordance with EN 60669-1

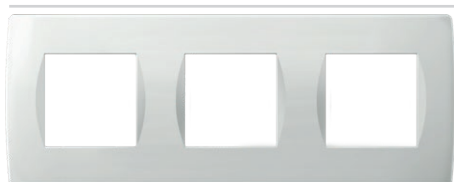

	OS26PW		OS26SG
	OS26IW		OS26NB
	OS26ES		OS26AT
	OS26SB		OS26TI
			OS26WW
			OS26WE

OKVIR SOFT 3x2M

- dekorativni okvir SOFT 3x2M
- vodoravna ili okomita ugradnja
- sukladno normi EN 60669-1

COVER PLATE SOFT 3x2M

- decorative cover plate SOFT 3x2M
- horizontal or vertical mounting
- in accordance with EN 60669-1



	OS28PW		OS28SG
	OS28IW		OS28NB
	OS28ES		OS28AT
	OS28SB		OS28TI
			OS28WW
			OS28WE

OKVIR SOFT 4x2M

- dekorativni okvir SOFT 4x2M
- vodoravna ili okomita ugradnja
- sukladno normi EN 60669-1

COVER PLATE SOFT 4x2M

- decorative cover plate SOFT 4x2M
- horizontal or vertical mounting
- in accordance with EN 60669-1

MODUL

SOFT

COVER PLATES SOFT OS



 OS30PW	 OS30SG
 OS30IW	 OS30NB
 OS30ES	 OS30AT
 OS30SB	 OS30TI
	 OS30WW
	 OS30WE









OKVIR SOFT 3M

- dekorativni okvir SOFT 3M
- sukladno normi EN 60669-1

COVER PLATE SOFT 3M

- decorative cover plate SOFT 3M
- in accordance with EN 60669-1



 OS40PW	 OS40SG
 OS40IW	 OS40NB
 OS40ES	 OS40AT
 OS40SB	 OS40TI
	 OS40WW
	 OS40WE

OKVIR SOFT 4M

- dekorativni okvir SOFT 4M
- sukladno normi EN 60669-1

COVER PLATE SOFT 4M

- decorative cover plate SOFT 4M
- in accordance with EN 60669-1



 OS70PW	 OS70SG
 OS70IW	 OS70NB
 OS70ES	 OS70AT
 OS70SB	 OS70TI
	 OS70WW
	 OS70WE

OKVIR SOFT 7M

- dekorativni okvir SOFT 7M
- sukladno normi EN 60669-1

COVER PLATE SOFT 7M

- decorative cover plate SOFT 7M
- in accordance with EN 60669-1



 OS72PW	 OS72AT
 OS72IW	 OS72TI
 OS72ES	
 OS72SB	

OKVIR SOFT 2x7M

- dekorativni okvir SOFT 2x7M s
natpisnom pločicom
- sukladno normi EN 60669-1

COVER PLATE SOFT 2x7M

- decorative cover plate SOFT 2x7M
with inscription plate
- in accordance with EN 60669-1



 OS10PW	 OS10SG
 OS10IW	 OS10NB
 OS10ES	 OS10AT
 OS10SB	 OS10TI
	 OS10WW
	 OS10WE

OKVIR SOFT 1/2M

- dekorativni okvir SOFT 1/2M
- sukladno normi EN 60669-1

COVER PLATE SOFT 1/2M

- decorative cover plate SOFT 1/2M
- in accordance with EN 60669-1

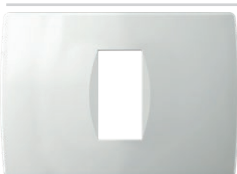

 OS13PW	 OS13SG
 OS13IW	 OS13NB
 OS13ES	 OS13AT
 OS13SB	 OS13TI
	 OS13WW
	 OS13WE

OKVIR SOFT 1/3M

- dekorativni okvir SOFT 1/3M
- sukladno normi EN 60669-1

COVER PLATE SOFT 1/3M

- decorative cover plate SOFT 1/3M
- in accordance with EN 60669-1

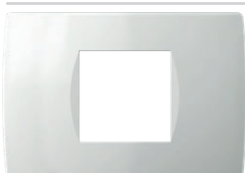

 OS23PW	 OS23SG
 OS23IW	 OS23NB
 OS23ES	 OS23AT
 OS23SB	 OS23TI
	 OS23WW
	 OS23WE

OKVIR SOFT 2/3M

- dekorativni okvir SOFT 2/3M
- sukladno normi EN 60669-1

COVER PLATE SOFT 2/3M

- decorative cover plate SOFT 2/3M
- in accordance with EN 60669-1

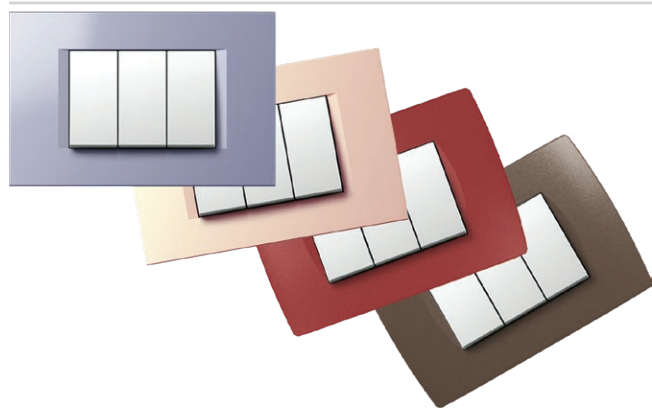











UKRAŠAVANJE OKVIRA

- kada se naručuje veća količina, okviri mogu se izraditi u boji prema Vašem izboru
- prikladno za okvire OL, OS

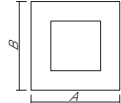
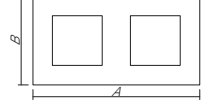
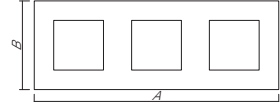
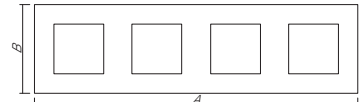
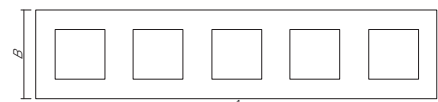
COVER PLATES DECORATIONS

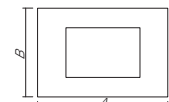
- when ordering large quantities, cover plates can be made in the colour of your choice
- suitable for cover plates OL, OS

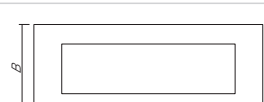
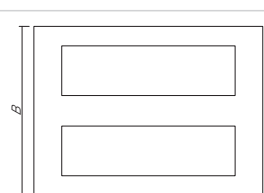
F R A M E S

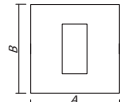
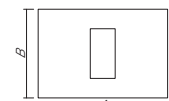
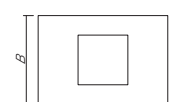
	 MODUL LINE A x B	 MODUL SOFT A x B	 MODUL PURE A x B
2M 	80 x 80 mm	84 x 84 mm	93 x 90 mm
2x2M 	151 x 80 mm	155 x 84 mm	164 x 90 mm
3x2M 	222 x 80 mm	226 x 84 mm	235 x 90 mm
4x2M 	293 x 80 mm	297 x 84 mm	304 x 90 mm
5x2M 	364,1 x 80 mm		
			
3M 	122 x 80 mm	122 x 84 mm	134 x 90 mm
4M 	149 x 80 mm	144 x 84 mm	157 x 90 mm
7M 	207 x 80 mm	212 x 84 mm	224 x 90 mm
2x7M 		212 x 158 mm	
			
1/2M 	80 x 80 mm	84 x 84 mm	
1/3M 	122 x 80 mm	122 x 84 mm	134 x 90 mm
2/3M 	122 x 80 mm	122 x 84 mm	134 x 90 mm

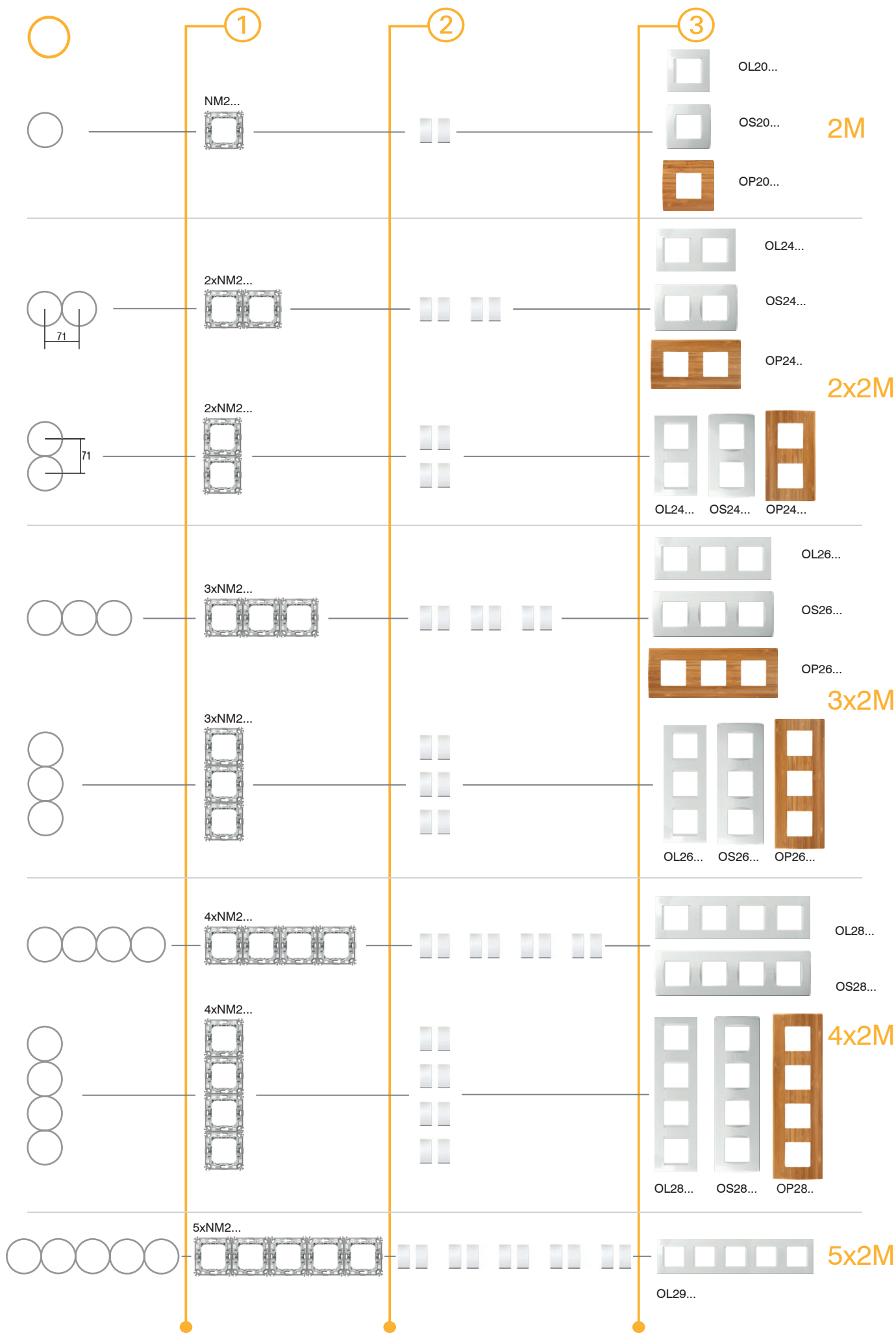

C O M B I N A T I O N S

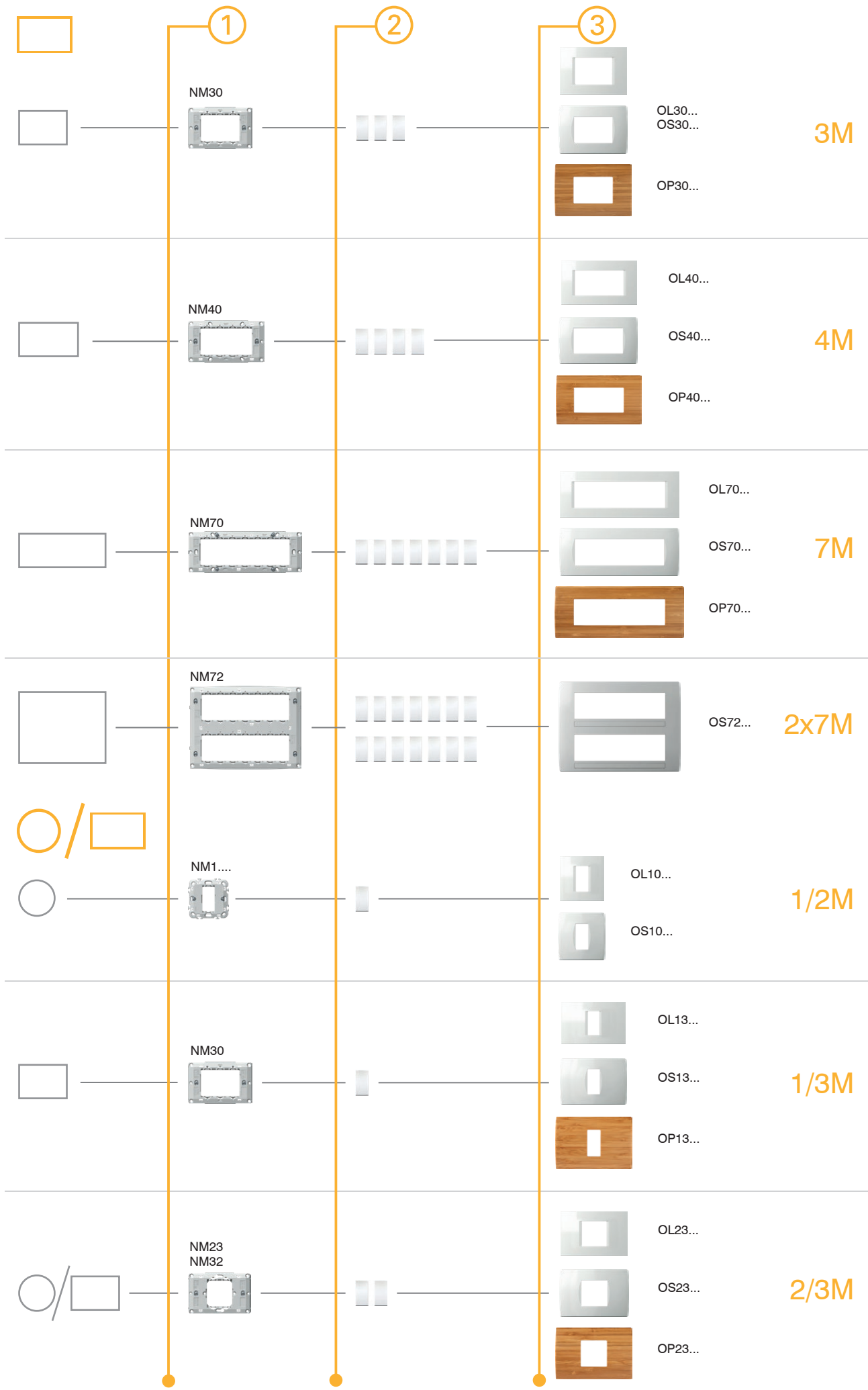

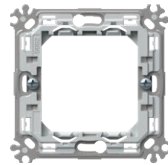
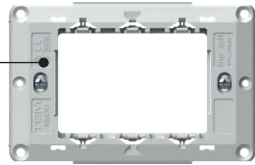

NM30

tip type	naziv description	veličina size
NM10	NOSAČ S NOŽICAMA MOUNTING FRAME WITH CLAWS	1/2M
NM11	NOSAČ BEZ VIJAKA MOUNTING FRAME WITHOUT SCREWS	1/2M
NM20	NOSAČ S NOŽICAMA MOUNTING FRAME WITH CLAWS	2M
...



NOSAČ S NOŽICAMA 2M

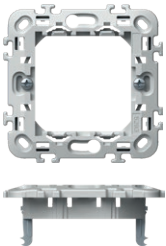

NM20

- nosač s nožicama 2M
- za ugradnju u kutije Ø60 (DE..) s nožicama
- moguće kombinacije vodoravne ili okomite ugradnje 2x2M, 3x2M i 4x2M
- prikladno za kombiniranje s okvirima LINE i SOFT
- sukladno normi EN 60669-1

MOUNTING FRAME WITH CLAWS 2M

- mounting frame 2M with claws
- for mounting on boxes Ø60 (DE..) with claws
- possible horizontal or vertical combinations 2x2M, 3x2M and 4x2M
- suitable for assembling with cover plates LINE and SOFT
- in accordance with EN 60669-1

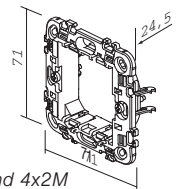

NOSAČ BEZ VIJAKA 2M

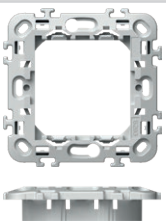

NM21

- nosač 2M bez vijaka i bez nožica
- za ugradnju u kutije Ø60 (HE..., BE..) s vijcima
- moguće kombinacije vodoravne ili okomite ugradnje 2x2M, 3x2M i 4x2M
- prikladno za kombiniranje s okvirima LINE i SOFT
- sukladno normi EN 60669-1

MOUNTING FRAME WITHOUT SCREWS 2M

- mounting frame 2M without screws and without claws
- for mounting on boxes Ø60 (HE..., BE..) with screws
- possible horizontal or vertical combinations 2x2M, 3x2M and 4x2M
- suitable for assembling with cover plates LINE and SOFT
- in accordance with EN 60669-1

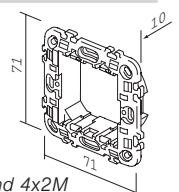

NOSAČ METALNI S NOŽICAMA 2M

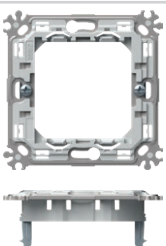

NM24

- metalni nosač 2M s nožicama - kruta inačica
- za ugradnju u kutije Ø60 (DE..) s nožicama
- moguće kombinacije vodoravne ili okomite ugradnje 2x2M, 3x2M i 4x2M
- prikladno za kombiniranje s okvirima PURE, LINE i SOFT
- sukladno normi EN 60669-1

MOUNTING FRAME METAL WITH CLAWS 2M

- metal mounting frame 2M with claws - stiff version
- for mounting on boxes Ø60 (DE..) with claws
- possible horizontal or vertical combinations 2x2M, 3x2M and 4x2M
- suitable for assembling with cover plates PURE, LINE and SOFT
- in accordance with EN 60669-1

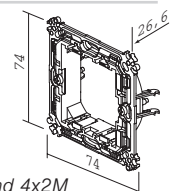

NOSAČ METALNI BEZ VIJAKA 2M

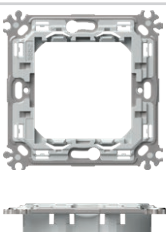

NM25

- metalni nosač 2M bez vijaka i bez nožica - kruta inačica
- za ugradnju u kutije Ø60 (HE..., BE...) s vijcima
- moguće kombinacije vodoravne ili okomite ugradnje 2x2M, 3x2M i 4x2M
- prikladno za kombiniranje s okvirima PURE, LINE i SOFT
- sukladno normi EN 60669-1

MOUNTING FRAME METAL WITHOUT SCREWS 2M

- metal mounting frame 2M without screws and without claws - stiff version
- for mounting in boxes Ø60 (HE..., BE...) with screws
- possible horizontal or vertical combinations 2x2M, 3x2M and 4x2M
- suitable for assembling with cover plates PURE, LINE and SOFT
- in accordance with EN 60669-1

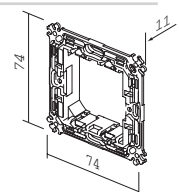

M O U N T I N G F R A M E S N M

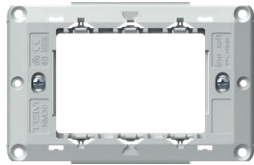

NM30

NOSAČ S VIJCIMA 3M

- nosač 3M s vijcima
 - za ugradnju u pravokutne kutije 3M
 - prikladno za kombiniranje s okvirima PURE, LINE i SOFT
 - sukladno normi EN 60669-1
- MOUNTING FRAME WITH SCREWS 3M*
- mounting frame 3M with screws
 - for mounting on rectangular boxes 3M
 - suitable for assembling with cover plates PURE, LINE and SOFT
 - in accordance with EN 60669-1

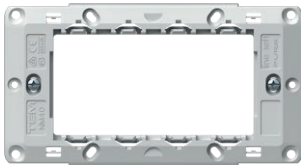
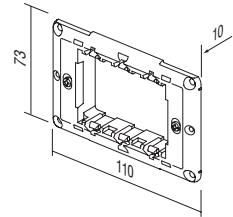

NM40

NOSAČ S VIJCIMA 4M

- nosač 4M s vijcima
 - za ugradnju u pravokutne kutije 4M
 - prikladno za kombiniranje s okvirima PURE, LINE i SOFT
 - sukladno normi EN 60669-1
- MOUNTING FRAME WITH SCREWS 4M*
- mounting frame 4M with screws
 - for mounting on rectangular boxes 4M
 - suitable for assembling with cover plates PURE, LINE and SOFT
 - in accordance with EN 60669-1

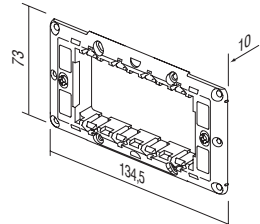

NM70

NOSAČ S VIJCIMA 7M

- nosač 7M s vijcima
 - za ugradnju u pravokutne kutije 7M
 - prikladno za kombiniranje s okvirima PURE, LINE i SOFT
 - sukladno normi EN 60669-1
- MOUNTING FRAME WITH SCREWS 7M*
- mounting frame 7M with screws
 - for mounting on rectangular boxes 7M
 - suitable for assembling with cover plates PURE, LINE and SOFT
 - in accordance with EN 60669-1

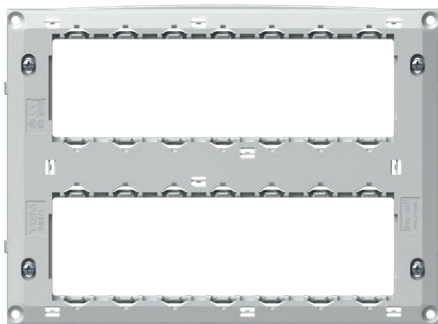
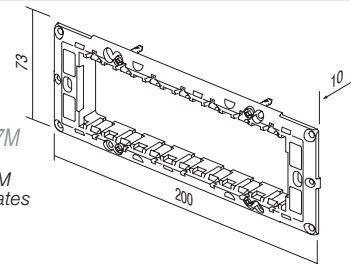

NM72

NOSAČ S VIJCIMA 2x7M

- nosač 2x7M s vijcima
 - za ugradnju u pravokutne kutije 2x7M
 - prikladan za sastavljanje s okvirom SOFT OS72
 - sukladno normi EN 60669-1
- MOUNTING FRAME WITH SCREWS 2x7M*
- mounting frame 2x7M with screws
 - for mounting on rectangular boxes 2x7M
 - suitable for assembling with cover plate SOFT OS72
 - in accordance with EN 60669-1

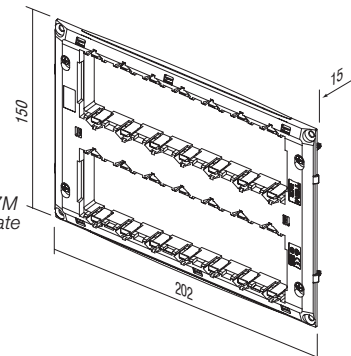

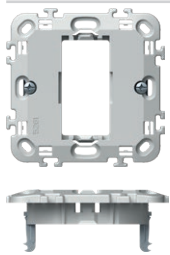

NOSAČ S NOŽICAMA 1/2M
NM10

- nosač 1/2M s nožicama
- za ugradnju u kutije Ø60 (DE..) s nožicama
- prikladno za kombiniranje s okvirima LINE i SOFT
- sukladno normi EN 60669-1

MOUNTING FRAME WITH CLAWS 1/2M
- mounting frame 1/2M with claws
- for mounting on boxes Ø60 (DE..) with claws
- suitable for assembling with cover plates LINE and SOFT
- in accordance with EN 60669-1

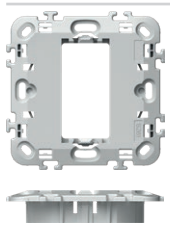
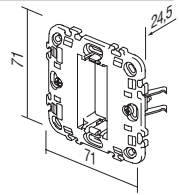

NOSAČ BEZ VIJAKA 1/2M
NM11

- nosač 1/2M bez vijaka i bez nožica
- za ugradnju u kutije Ø60 (HE.., BE..) s vijcima
- prikladno za kombiniranje s okvirima LINE i SOFT
- sukladno normi EN 60669-1

MOUNTING FRAME WITHOUT SCREWS 1/2M
- mounting frame 1/2M without screws and without claws
- for mounting on boxes Ø60 (HE.., BE..) with screws
- suitable for assembling with cover plates LINE and SOFT
- in accordance with EN 60669-1

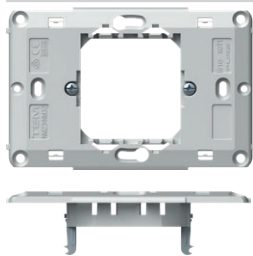
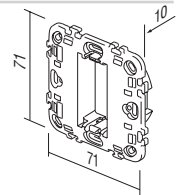

NOSAČ S NOŽICAMA 2/3M
NM23

- nosač 2/3M s nožicama
- za ugradnju u kutije Ø60 (DE..) s nožicama
- prikladno za kombiniranje s okvirima PURE, LINE i SOFT
- sukladno normi EN 60669-1

MOUNTING FRAME WITH CLAWS 2/3M
- mounting frame 2/3M with claws
- for mounting on boxes Ø60 (DE..) with claws
- suitable for assembling with cover plates PURE, LINE and SOFT
- in accordance with EN 60669-1

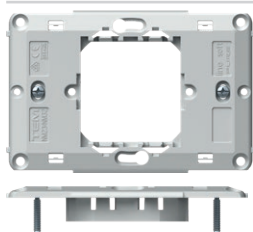
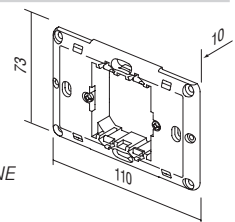

NOSAČ S VIJCIMA 2/3M
NM32

- nosač 2/3M s vijcima
- za ugradnju u pravokutne kutije 3M
- prikladno za kombiniranje s okvirima PURE, LINE i SOFT
- sukladno normi EN 60669-1

MOUNTING FRAME WITH SCREWS 2/3M
- mounting frame 2/3M with screws
- for mounting on rectangular boxes 3M
- suitable for assembling with cover plates PURE, LINE and SOFT
- in accordance with EN 60669-1

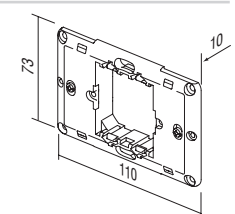



110



118



126



128





KUTIJE

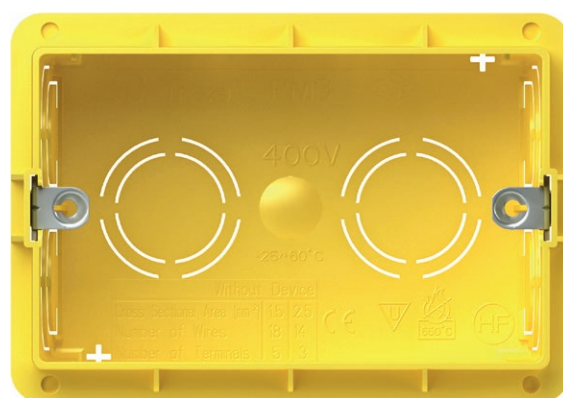

TEM



DE12



HE11



BE10

tip type	naziv description	veličina size
DE10	KUTIJA OKRUGLA ZA ZID OD OPEKE ROUND BOX BRICK	SM60-01
HE10	KUTIJA OKRUGLA ZA ŠUPLJE ZIDOVE ROUND BOX HOLLOW WALL	SM68X40
BE10	KUTIJA OKRUGLA ZA BETON ROUND BOX CONCRETE	
·	·	·
·	·	·

KUTIJA OKRUGLA ZA ZID OD OPEKE SM60-01



DE10

- Ø60, dubina 40mm
- 650°C, 500V ~
- sukladno normi IEC 60670-1
- bez halogena
- mogućnost pričvršćivanja nosača vijkom Ø 3 mm

ROUND BOX BRICK SM60-01

- Ø60, depth 40mm
- 650°C, 500V~
- in accordance with IEC 60670-1
- halogen free
- option of mounting the mounting frame with Ø 3 mm screws

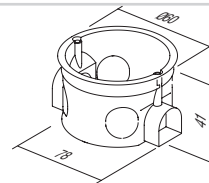

KUTIJA OKRUGLA ZA ZID OD OPEKE DUBOKA SM60-06



DE11

- Ø60, dubina 60mm
- 650°C, 500V ~
- sukladno normi IEC 60670-1
- bez halogena
- mogućnost pričvršćivanja nosača vijkom Ø 3 mm

ROUND BOX BRICK DEEP SM60-06

- Ø60, depth 60mm
- 650°C, 500V~
- in accordance with IEC 60670-1
- halogen free
- option of mounting the mounting frame with Ø 3 mm screws

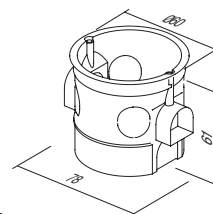

VEZNI ČLAN SM60-03



DE30

- za okomito povezivanje kutija SM60-06 ili SM60-01 na razmaku od 91 mm
- sukladno normi IEC 60670-1
- bez halogena

COMBI-CLIP SM60-03

- for vertical fitting of boxes SM60-06 or SM60-01 on distance 91 mm
- in accordance with IEC 60670-1
- halogen free

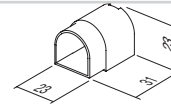

VEZNI ČLAN SM60-04

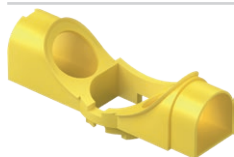

DE31







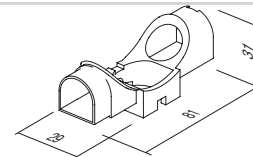



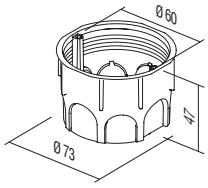

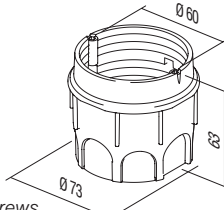
- za vodoravno povezivanje kutija SM60-06 ili SM60-01 na razmaku od 71 mm
- sukladno normi IEC 60670-1
- bez halogena

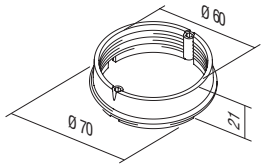
COMBI-CLIP SM60-04

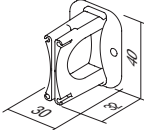
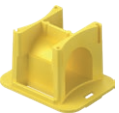
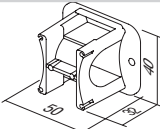
- for horizontal fitting of boxes SM60-06 or SM60-01 on distance 71mm
- in accordance with IEC 60670-1
- halogen free

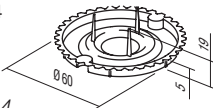

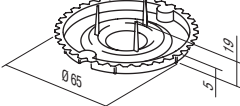
R O U N D B O X E S

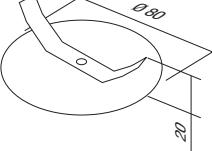
	DE12	KUTIJA OKRUGLA ZA ZID OD OPEKE MD65-46	<ul style="list-style-type: none"> - Ø65, dubina 46mm - 650 °C, 500V ~ - sukladno normi IEC 60670-1 - bez halogena - mogućnost pričvršćivanja nosača vijkom Ø 3 mm 	
	DE13	KUTIJA OKRUGLA ZA ZID OD OPEKE DUBOKA MD65-60	<ul style="list-style-type: none"> - Ø65/60, dubina 62mm - 650 °C, 500V ~ - sukladno normi IEC 60670-1 - bez halogena - mogućnost pričvršćivanja nosača vijkom Ø 3 mm 	
	DE14	PRODUŽETAK ZA MD65-46	<ul style="list-style-type: none"> - Ø65/60, dubina 17mm - 650 °C, 500V ~ - sukladno normi IEC 60670-1 - bez halogena 	
	DE32	VEZNI ČLAN MD65-71	<ul style="list-style-type: none"> - za povezivanje kutija MD65 na razmaku od 71mm - sukladno normi IEC 60670-1 - bez halogena 	
	DE33	VEZNI ČLAN MD65-91	<ul style="list-style-type: none"> - za povezivanje kutija MD65 na razmaku od 91mm - sukladno normi IEC 60670-1 - bez halogena 	
	DE20	POKLOPAC KUTIJE ZAŠTITNI 60	<ul style="list-style-type: none"> - zaštitni poklopac za kutiju Ø60 za DE10, DE11, DE13, DE14 - sukladno normi IEC 60670-1 - zaštita kutije tijekom žbukanja 	
	DE21	POKLOPAC KUTIJE ZAŠTITNI 65	<ul style="list-style-type: none"> - zaštitni poklopac za kutiju Ø65 za DE12 - sukladno normi IEC 60670-1 - zaštita kutije tijekom žbukanja 	
	DE22	POKLOPAC KUTIJE DEKORATIVNI SM60	<ul style="list-style-type: none"> - dekorativni poklopac za kutije Ø60 - sukladno normi IEC 60670-1 - bez halogena 	



upute za ugradnju /
assembly instructions

razmak između kutija /
distance between boxes: 71 mm

razmak između kutija /
distance between boxes: 91 mm

DE10,11

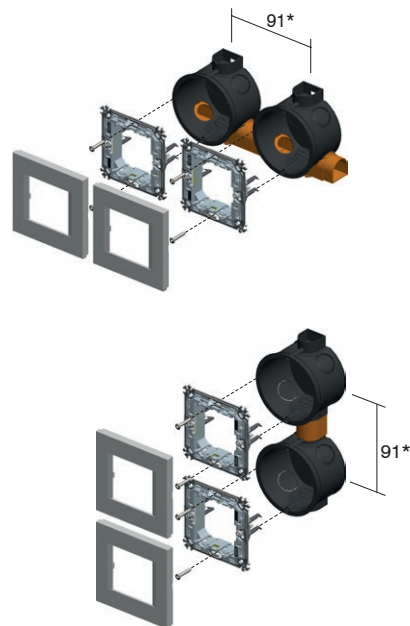
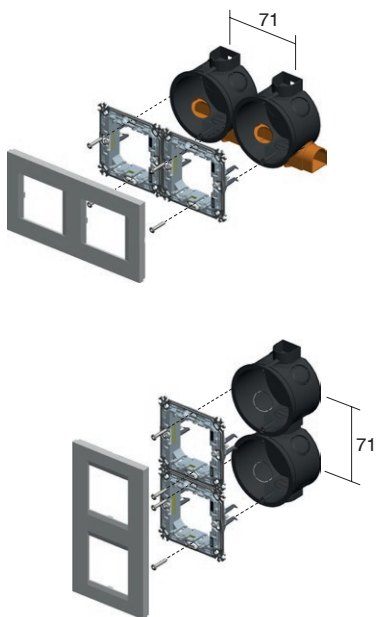
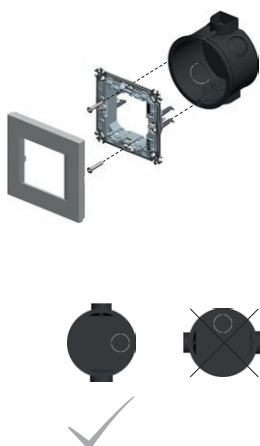

DE12,13

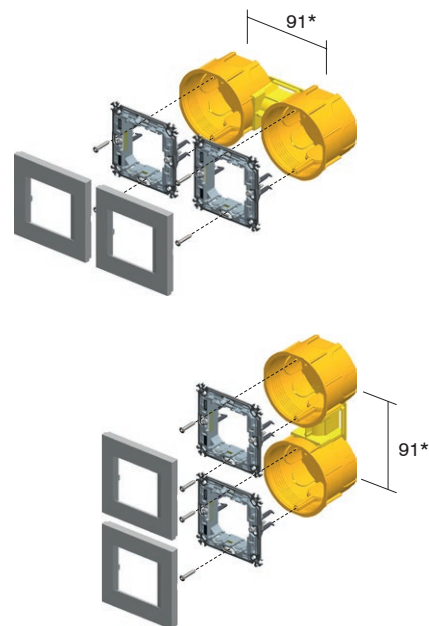
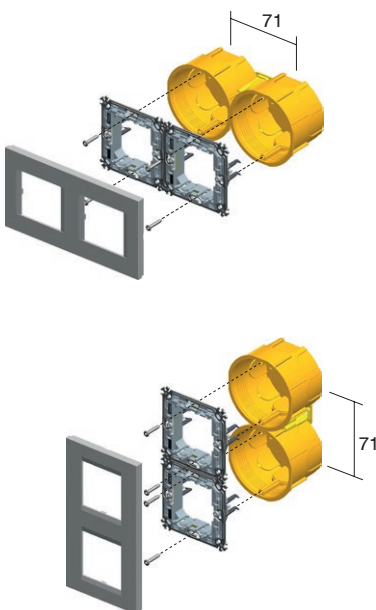
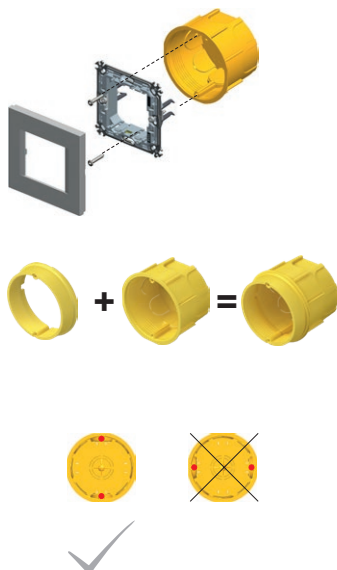

* za okvire PURE, min. razmak između kutija je 100 mm
* for PURE cover plates the minimum distance between boxes is 100mm

R O U N D B O X E S



DE10,11



DE12,13



NM20



NM24



DE10,11



DE12,13



NM10



DE10,11



DE12,13



NM23



71

2xDE10,11 + 2xDE31



2xDE12,13 + 1xDE32



2xNM20



2xNM24



2xDE10,11 2xDE12,13 + 1xDE32



2xNM20



2xNM24



3xDE10,11 + 3xDE31



3xDE12,13 + 2xDE32



3xNM20



3xNM24

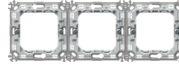

3xDE10,11 3xDE12,13 + 2xDE32



3xNM20



3xNM24



4xDE10,11 + 4xDE31



4xDE12,13 + 3xDE32



4xNM20



4xNM24



4xDE10,11 4xDE12,13 + 3xDE32

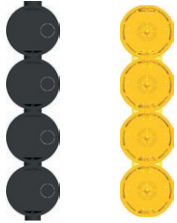

4xNM20



4xNM24



5xDE10,11



5xDE12,13 + 4xDE32



5xNM20



5xNM24



KUTIJA OKRUGLA ZA ŠUPLJE ZIDOVE SM68x40



HE10

- Ø60, dubina 40mm
- ugradni promjer Ø68
- 850°C, 400V~
- sukladno normi IEC 60670-1
- ugradnja s nožicama
- bez halogena
- pričvršćivanje nosača vijkom Ø 3 mm

ROUND BOX HOLLOW WALL SM68x40

- Ø60, depth 40mm
- cutting hole Ø68
- 850°C, 400V~
- in accordance with IEC 60670-1
- mounting with claws
- halogen free
- mounting the mounting frame with Ø 3 mm screws

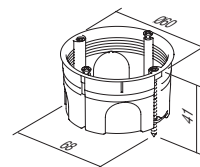

KUTIJA OKRUGLA ZA ŠUPLJE ZIDOVE SM68x55



HE11

- Ø60, dubina 55mm
- ugradni promjer Ø68
- 850°C, 400V~
- sukladno normi IEC 60670-1
- ugradnja s nožicama
- bez halogena
- pričvršćivanje nosača vijkom Ø 3 mm

ROUND BOX HOLLOW WALL SM68x55

- Ø60, depth 55mm
- cutting hole Ø68
- 850°C, 400V~
- in accordance with IEC 60670-1
- mounting with claws
- halogen free
- mounting the mounting frame with Ø 3 mm screws

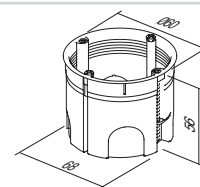

KUTIJA OKRUGLA ZA BETON



BE10

- Ø60 mm, dubina 49 mm
- 650°C, 500V~
- sukladno normi IEC 60670-1
- bez halogena
- pričvršćivanje nosača vijkom Ø 3 mm

ROUND BOX CONCRETE

- Ø60mm, depth 49mm
- 650°C, 500V~
- in accordance with IEC 60670-1
- halogen free
- mounting the mounting frame with Ø 3 mm screws

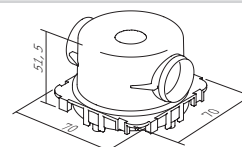

KUTIJA OKRUGLA ZA BETON DUBOKA



BE11

- Ø60 mm, dubina 58mm
- 650°C, 500V~
- sukladno normi IEC 60670-1
- bez halogena
- pričvršćivanje nosača vijkom Ø 3 mm

ROUND BOX CONCRETE DEEP

- Ø60mm, depth 58mm
- 650°C, 500V~
- in accordance with IEC 60670-1
- halogen free
- mounting the mounting frame with Ø 3 mm screws

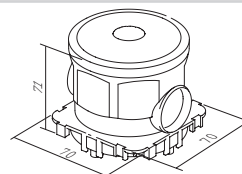

NOSAČ KUTIJE ZA BETON



BE20

- za učvršćivanje doze dilatacijskim profilom BM82 u suprotni zid
- sukladno normi IEC 60670-1
- bez halogena

COUNTER BOX SUPPORT CONCRETE

- to support concrete boxes with discance profile BM82 for extreme loads
- in accordance with IEC 60670-1
- halogen free

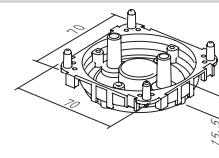

UVODNICA ZA KUTIJU ZA BETON 16



BE21

- za učvršćivanje instalacijske cijevi
- sukladno normi IEC 60670-1
- bez halogena

PIPE STOPPER CONCRETE BOX 16

- for firming installation pipe to box
- in accordance with IEC 60670-1
- halogen free

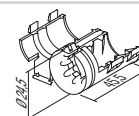

R O U N D B O X E S

šuplji zidovi / hollow walls



beton / concrete



upute za ugradnju /
assembly instructions

razmak između kutija /
distance between boxes: 71mm

razmak između kutija /
distance between boxes: 91mm

HE10,11

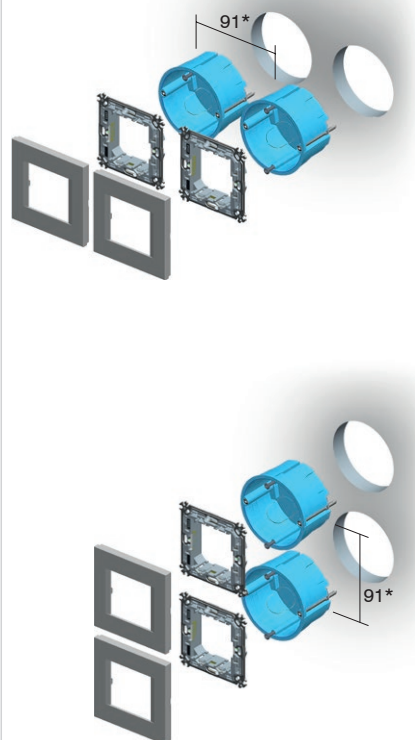
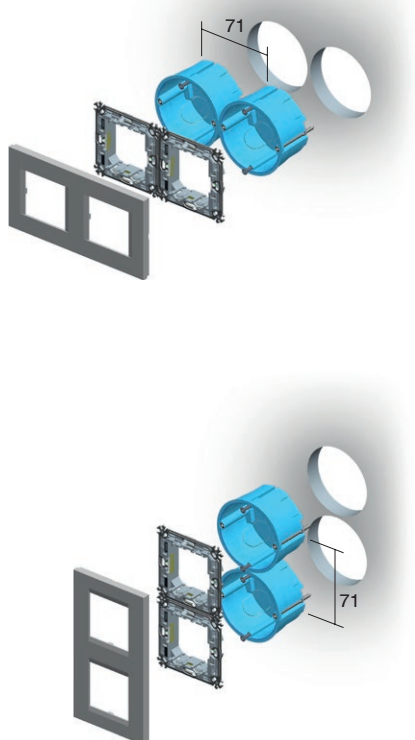
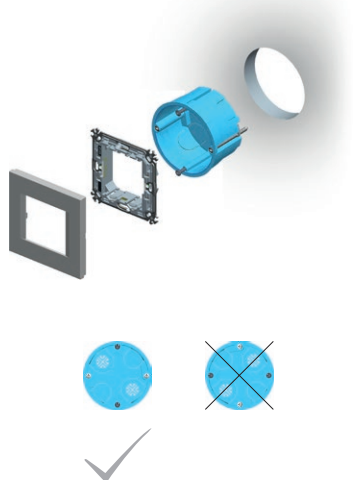

BE10

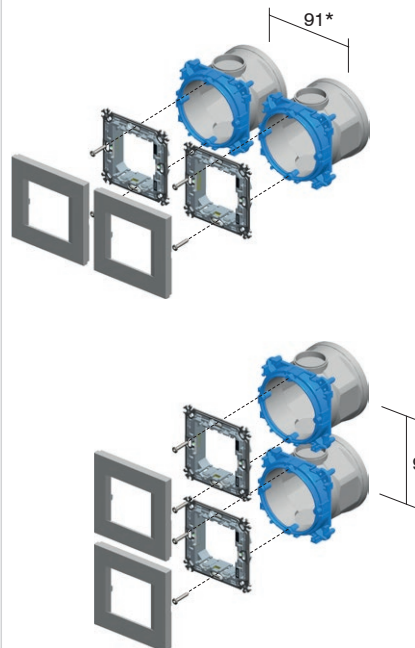
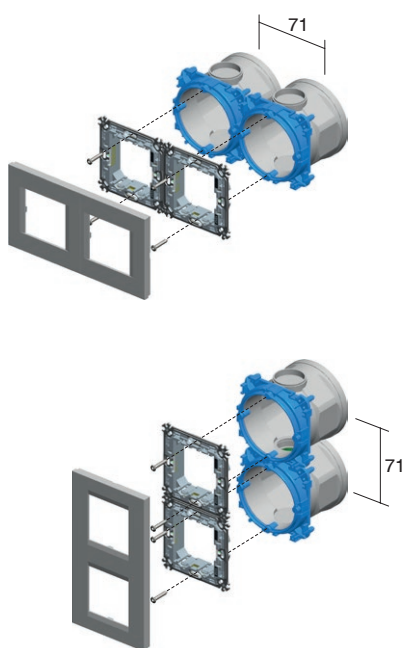
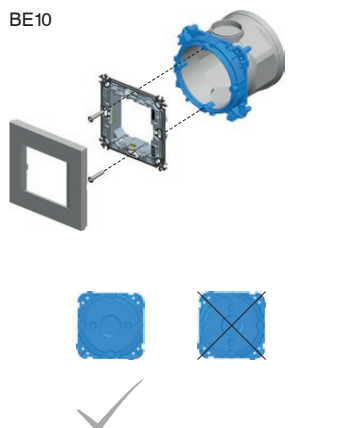

* za okvire PURE, min. razmak između kutija je 100 mm

* for PURE cover plates the minimum distance between boxes is 100mm

K U T I J E O K R U G L E

šuplji zidovi / hollow walls



beton / concrete



HE10,11



BE10,11



NM21



NM25



2M

HE10,11



BE10,11



NM11



1/2M

2xHE10,11



2xBE10,11



2xNM21



2xNM25



2x2M

HE10,11



BE10,11



NM32



2/3M

2xHE10,11



2xBE10,11



2xNM21



2xNM25



5xHE10,11



5xNM21



5xBE10,11



5xNM25



5x2M

3xHE10,11

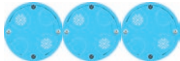

3xBE10,11



3xNM21



3xNM25

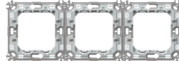

3x2M

3xHE10,11



3xBE10,11



3xNM21



3xNM25

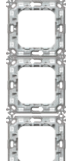

4xHE10,11



4xBE10,11



4xNM21



4xNM25



4x2M

4xHE10,11



4xBE10,11



4xNM21



4xNM25



R O U N D B O X E S

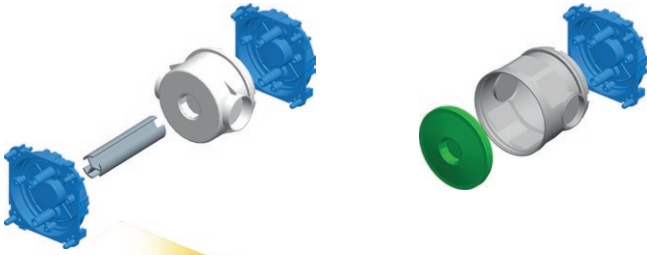

upute za ugradnju /
assembly instructions

1

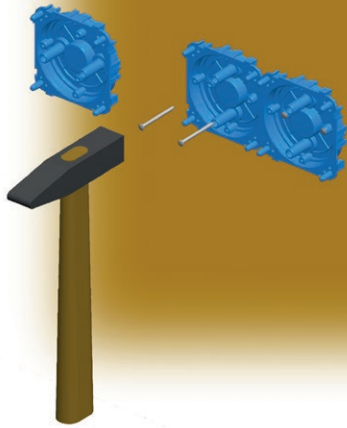

2

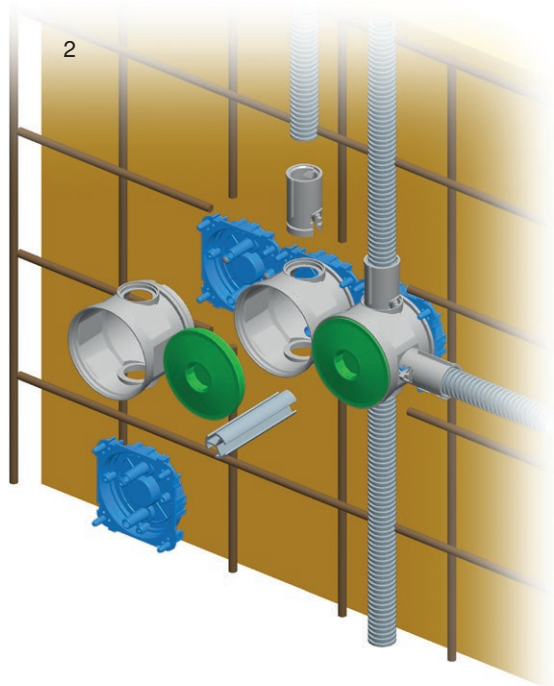

3

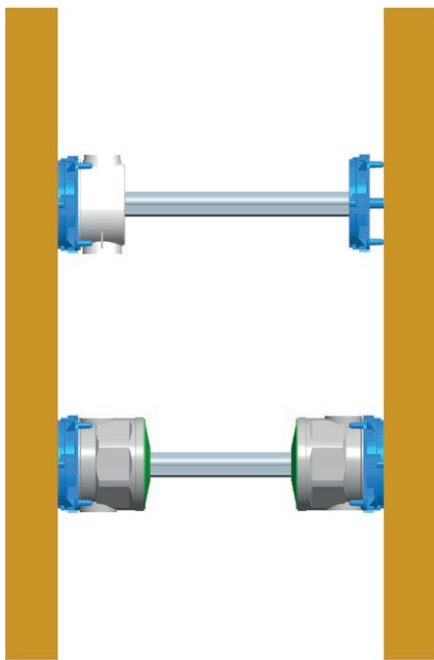

4

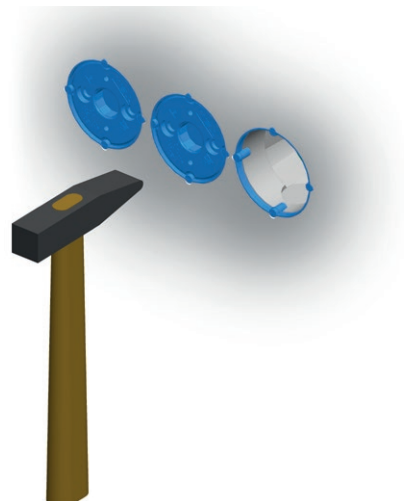

K U T I J E P R A V O K U T N E



DM30



HM30



BM30

tip type	naziv description	veličina size
DM30	KUTIJA PRAVOKUTNA ZA ZID OD OPEKE <i>RECTANGULAR BOX BRICK</i>	PM3
HM30	KUTIJA PRAVOKUTNA ZA ŠUPLJE ZIDOVE <i>RECTANGULAR BOX HOLLOW WALL</i>	VM3
BM30	KUTIJA PRAVOKUTNA ZA BETON <i>RECTANGULAR BOX CONCRETE</i>	BM3
·	·	·
·	·	·

KUTIJA PRAVOKUTNA ZA ZID OD OPEKE PM3



DM30

- veličina 3M, dubina 49 mm
- 650°C, 400V ~
- sukladno normi IEC 60670-1
- bez halogena

RECTANGULAR BOX BRICK PM3

- size 3M, depth 49mm
- 650°C, 400V~
- in accordance with IEC 60670-1
- halogen free

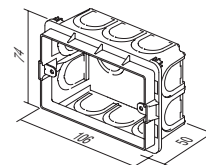

KUTIJA PRAVOKUTNA ZA ZID OD OPEKE PM3-65



DM31

- veličina 3M, dubina 65mm
- 650°C, 400V ~
- sukladno normi IEC 60670-1
- bez halogena

RECTANGULAR BOX BRICK PM3-65

- size 3M, depth 65mm
- 650°C, 400V~
- in accordance with IEC 60670-1
- halogen free

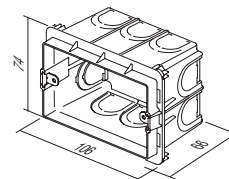

KUTIJA PRAVOKUTNA ZA ZID OD OPEKE PM4



DM40

- veličina 4M, dubina 49 mm
- 650°C, 400V ~
- sukladno normi IEC 60670-1
- bez halogena

RECTANGULAR BOX BRICK PM4

- size 4M, depth 49mm
- 650°C, 400V~
- in accordance with IEC 60670-1
- halogen free

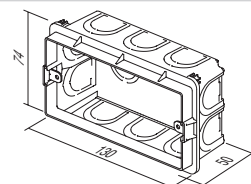

KUTIJA PRAVOKUTNA ZA ZID OD OPEKE PM4-65



DM41

- veličina 4M, dubina 65mm
- 650°C, 400V ~
- sukladno normi IEC 60670-1
- bez halogena

RECTANGULAR BOX BRICK PM4-65

- size 4M, depth 65mm
- 650°C, 400V~
- in accordance with IEC 60670-1
- halogen free

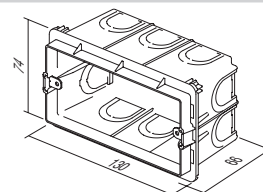

R E C T A N G U L A R B O X E S

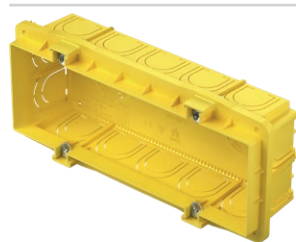

DM70

KUTIJA PRAVOKUTNA ZA ZID OD OPEKE PM7

- veličina 7M, dubina 49 mm
- 650°C, 400V ~
- sukladno normi IEC 60670-1
- bez halogena

RECTANGULAR BOX BRICK PM7

- size 7M, depth 49mm
- 650°C, 400V~
- in accordance with IEC 60670-1
- halogen free

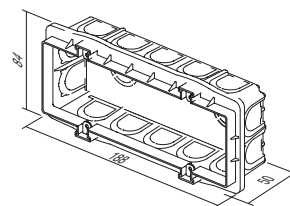

DM71

KUTIJA PRAVOKUTNA ZA ZID OD OPEKE PM7-65

- veličina 7M, dubina 65mm
- 650°C, 400V ~
- sukladno normi IEC 60670-1
- bez halogena

RECTANGULAR BOX BRICK PM7-65

- size 7M, depth 65mm
- 650°C, 400V~
- in accordance with IEC 60670-1
- halogen free

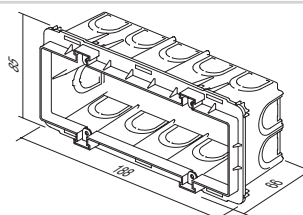

DM72

KUTIJA PRAVOKUTNA ZA ZID OD OPEKE PM72-65

- veličina 2x7M, dubina 64mm
- 650°C, 400V ~
- sukladno normi IEC 60670-1
- bez halogena

RECTANGULAR BOX BRICK PM72-65

- size 2x7M, depth 64mm
- 650°C, 400V~
- in accordance with IEC 60670-1
- halogen free

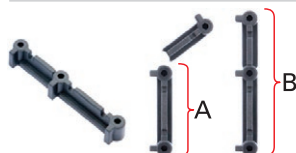
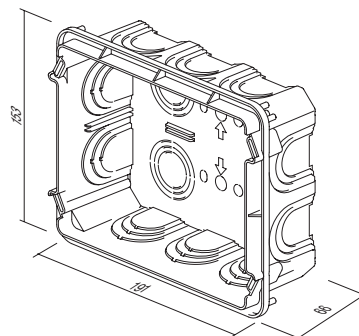

DM80

VEZNI ČLAN KUTIJE PM

- za okomito (A) i vodoravno (B) povezivanje kutija PM3, PM4 i PM7
- prikladan za dekorativne okvire Line i Soft (nije prikladan za PURE)

DISTANCE PIECE FOR BOX PM

- for vertical (A) and horizontal (B) fitting of boxes PM3, PM4 and PM7
- suitable for Line and Soft decorative cover plates (not for PURE)

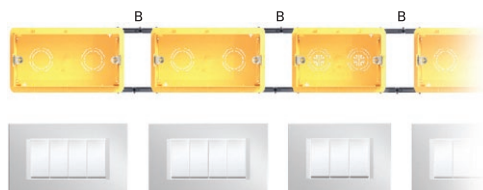
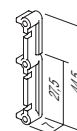

K U T I J E P R A V O K U T N E

POKLOPAC KUTIJE ZAŠTITNI PM3



DM33

- zaštitni poklopac za kutiju PM3
- sukladno normi IEC 60670-1
- bez halogena
- zaštita kutije tijekom žbukanja

BOX COVER PROTECTIVE PM3

- protective cover for box PM3
- in accordance with IEC 60670-1
- halogen free
- box protection during plastering

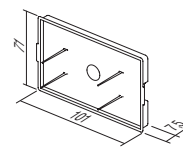

POKLOPAC KUTIJE DEKORATIVNI PM3



DM34

- dekorativni poklopac za kutije 3M
- vijci priloženi
- sukladno normi IEC 60670-1
- bez halogena

BOX COVER DECORATIVE PM3

- decorative cover for boxes 3M
- screws are included
- in accordance with IEC 60670-1
- halogen free

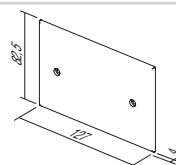

POKLOPAC KUTIJE ZAŠTITNI PM4



DM43

- zaštitni poklopac za kutiju PM4
- sukladno normi IEC 60670-1
- bez halogena
- zaštita kutije tijekom žbukanja

BOX COVER PROTECTIVE PM4

- protective cover for box PM4
- in accordance with IEC 60670-1
- halogen free
- box protection during plastering

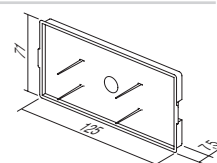

POKLOPAC KUTIJE DEKORATIVNI PM4



DM44

- dekorativni poklopac za kutije 4M
- vijci priloženi
- sukladno normi IEC 60670-1
- bez halogena

BOX COVER DECORATIVE PM4

- decorative cover for boxes 4M
- screws are included
- in accordance with IEC 60670-1
- halogen free

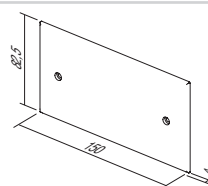

POKLOPAC KUTIJE ZAŠTITNI PM7

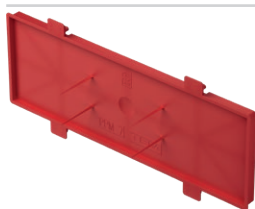

DM73

- zaštitni poklopac za kutiju PM7
- sukladno normi IEC 60670-1
- bez halogena
- zaštita kutije tijekom žbukanja

BOX COVER PROTECTIVE PM7

- protective cover for box PM7
- in accordance with IEC 60670-1
- halogen free
- box protection during plastering

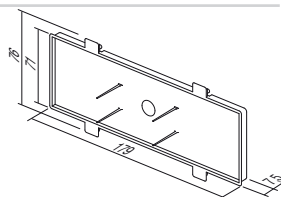

POKLOPAC KUTIJE DEKORATIVNI PM7



DM74

- dekorativni poklopac za kutije 7M
- vijci priloženi
- sukladno normi IEC 60670-1
- bez halogena

BOX COVER DECORATIVE PM7

- decorative cover for boxes 7M
- screws are included
- in accordance with IEC 60670-1
- halogen free

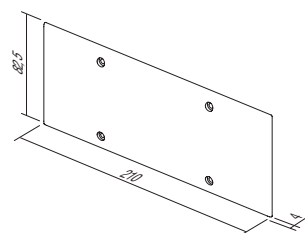

R E C T A N G U L A R B O X E S



DM75

POKLOPAC KUTIJE DEKORATIVNI PM72

- dekorativni poklopac za kutije 2x7M
- vijci priloženi
- sukladno normi IEC 60670-1

BOX COVER DECORATIVE PM72
- decorative cover for boxes 2x7M
- screws are included
- in accordance with IEC 60670-1

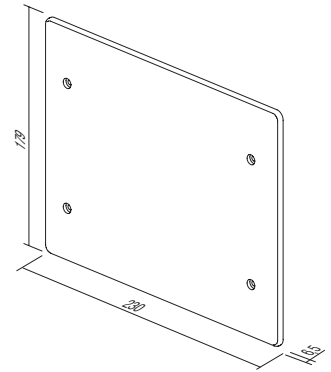

K U T I J E P R A V O K U T N E

KUTIJA PRAVOKUTNA ZA ŠUPLJE ZIDOVE VM3



HM30

- veličina 3M, dubina 49 mm
- ugradni promjer 2xØ68/45mm
- 850°C, 400V ~
- sukladno normi IEC 60670-1
- bez halogena

RECTANGULAR BOX HOLLOW WALL VM3

- size 3M, depth 49mm
- cutting hole 2xØ68/45mm
- 850°C, 400V ~
- in accordance with IEC 60670-1
- halogen free

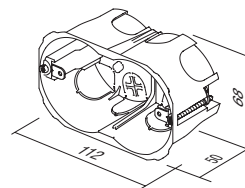

KUTIJA PRAVOKUTNA ZA ŠUPLJE ZIDOVE VM4



HM40

- veličina 4M, dubina 49 mm
- ugradni promjer 2xØ68/70mm
- 850°C, 400V ~
- sukladno normi IEC 60670-1
- bez halogena

RECTANGULAR BOX HOLLOW WALL VM4

- size 4M, depth 49mm
- cutting hole 2xØ68/70mm
- 850°C, 400V ~
- in accordance with IEC 60670-1
- halogen free

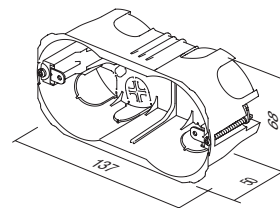

KUTIJA PRAVOKUTNA ZA ŠUPLJE ZIDOVE VM7



HM70

- veličina 7M, dubina 49 mm
- ugradni promjer 2xØ68/120mm
- 850°C, 400V ~
- sukladno normi IEC 60670-1
- bez halogena

RECTANGULAR BOX HOLLOW WALL VM7

- size 7M, depth 49mm
- cutting hole 2xØ68/120mm
- 850°C, 400V ~
- in accordance with IEC 60670-1
- halogen free

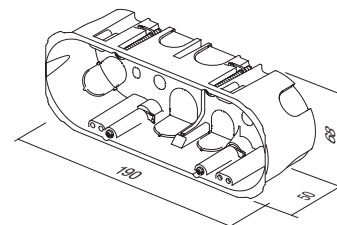

KUTIJA PRAVOKUTNA ZA ŠUPLJE ZIDOVE VM72



HM72







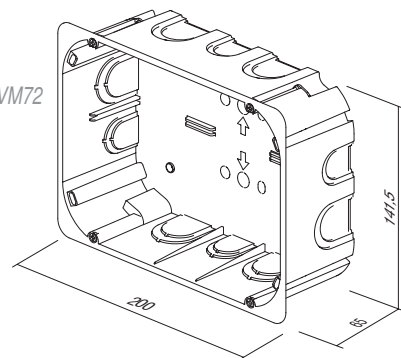

- veličina 2x7M, dubina 63mm
- 850°C, 400V ~
- sukladno normi IEC 60670-1
- bez halogena

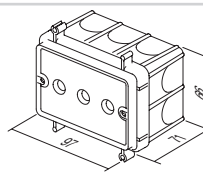
RECTANGULAR BOX HOLLOW WALL VM72

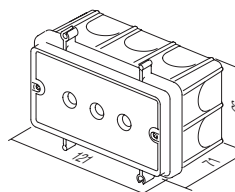
- size 2x7M, depth 63mm
- 850°C, 400V ~
- in accordance with IEC 60670-1
- halogen free

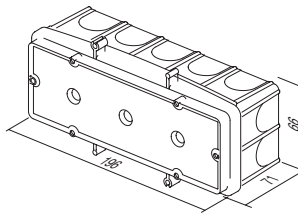

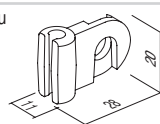
R E C T A N G U L A R B O X E S

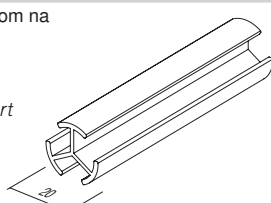
	BM30	PRAVOKUTNA KUTIJA ZA BETON BM3 - veličina 3M, dubina 60mm - 650°C, 400V ~ - sukladno normi IEC 60670-1 - bez halogena <i>RECTANGULAR BOX CONCRETE BM3</i> - size 3M, depth 60mm - 650°C, 400V ~ - in accordance with IEC 60670-1 - halogen free	
	BM40	PRAVOKUTNA KUTIJA ZA BETON BM4 - veličina 4M, dubina 60mm - 650°C, 400V ~ - sukladno normi IEC 60670-1 - bez halogena <i>RECTANGULAR BOX CONCRETE BM4</i> - size 4M, depth 60mm - 650°C, 400V ~ - in accordance with IEC 60670-1 - halogen free	
	BM70	PRAVOKUTNA KUTIJA ZA BETON BM7 - veličina 7M, dubina 60mm - 650°C, 400V ~ - sukladno normi IEC 60670-1 - bez halogena <i>RECTANGULAR BOX CONCRETE BM7</i> - size 7M, depth 60mm - 650°C, 400V ~ - in accordance with IEC 60670-1 - halogen free	
	BM80	PRIČVRSNI KOMBI-DRŽAČ BM - za brzo pričvršćivanje pravokutnih kutija BM na armiranu betonsku šipku - prikladno za šipku promjera do Ø8 mm <i>FIXING COMBI-CLIP BM</i> - for fast fixation of BM rectangular boxes on reinforcing bar - suitable for bar diameter up to Ø8mm	
	BM82	VEZNI PROFIL ZA KUTIJE BM - za podupiranje kutija BM s odgovarajućom kutijom na nasuprotnom zidu - duljina l = 1 m, promjer Ø20 mm <i>DISTANCE PROFIL FOR BOXES BM</i> - to support boxes BM with counter box support on opposite wall - length l=1m, diameter Ø20mm	

K U T I J E P R A V O K U T N E



cigla / brick



šuplji zidovi / hollow walls



beton / concrete



DM30



NM30



HM30



BM30



3M

DM40



NM40



HM40



BM40



4M

DM70



NM70



HM70



BM70



7M

DM72



NM72

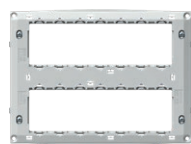

HM72



2x7M

DM30



NM32



HM30



BM30



2/3M

R E C T A N G U L A R B O X E S

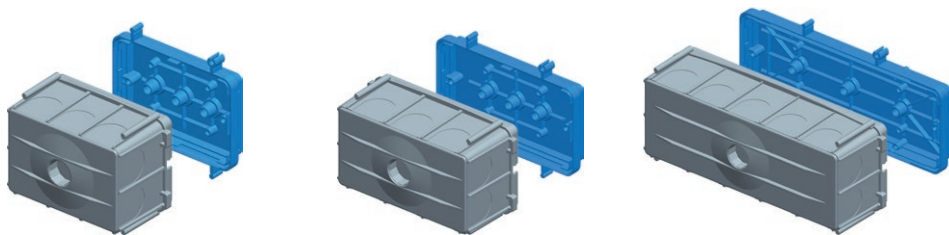

upute za ugradnju /
assembly instructions

1

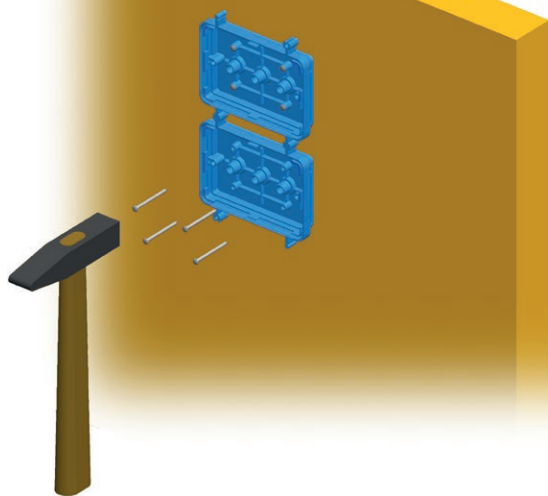

2

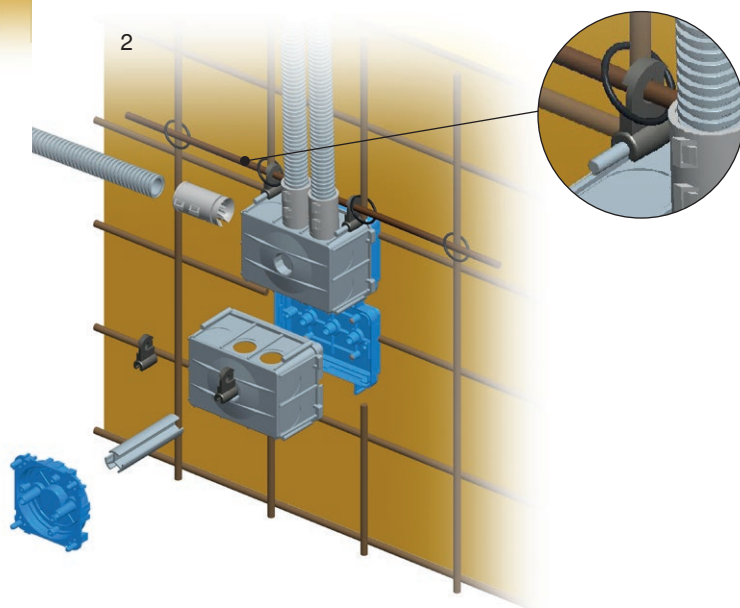

3

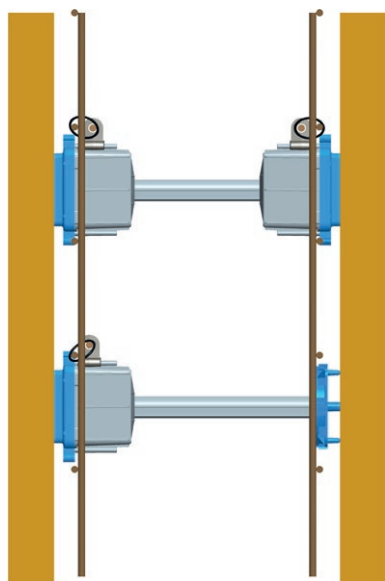

4

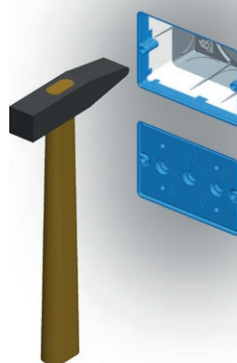

K U T I J E P R I K L J U Č N E

KUTIJA PRIKLJUČNA OKRUGLA ZA ZID OD OPEKE DSM78



DW10

- Ø78, dubina 40mm
- 650°C, 500V ~
- sukladno normama IEC 60670-1 i IEC 60670-22
- bez halogena

CONNECTION ROUND BOX BRICK DSM78

- Ø78, depth 40mm
- 650°C, 500V ~
- in accordance with IEC 60670-1 and IEC 60670-22
- halogen free

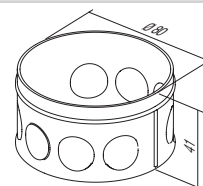

KUTIJA PRIKLJUČNA OKRUGLA ZA ŠUPLJE ZIDOVE SM78x45



HW10

- Ø78, dubina 45mm
- ugradni promjer Ø80
- 850°C, 400V ~
- sukladno normama IEC 60670-1 i IEC 60670-22
- ugradnja s nožicama
- bez halogena

CONNECTION ROUND BOX HOLLOW WALL SM78x45

- Ø78, depth 45mm
- cutting hole Ø80
- 850°C, 400V ~
- in accordance with IEC 60670-1 and IEC 60670-22
- mounting with claws
- halogen free

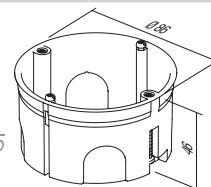

POKLOPAC KUTIJE DEKORATIVNI SM78



DE23

- dekorativni poklopac za kutije Ø78
- sukladno normama IEC 60670-1 i IEC 60670-22
- bez halogena

BOX COVER DECORATIVE SM78

- decorative cover for boxes Ø78
- in accordance with IEC 60670-1 and IEC 60670-22
- halogen free

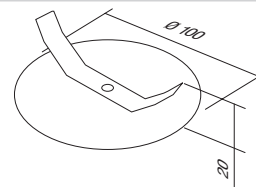

POKLOPAC KUTIJE ZAŠTITNI 78



DE24

- zaštitni poklopac za kutije Ø78
- sukladno normama IEC 60670-1 i IEC 60670-22
- bez halogena

BOX COVER PROTECTIVE 78

- protective cover for box Ø78
- in accordance with IEC 60670-1 and IEC 60670-22
- halogen free

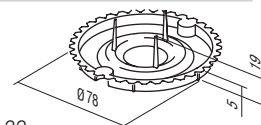

KUTIJA PRIKLJUČNA ČETVRTASTA ZA ZID OD OPEKE SM105x105



HW20

- veličina 105x105mm, dubina 50mm
- ugradnja u rupu prema priloženoj šabloni
- 850°C, 400V ~
- sukladno normama IEC 60670-1 i IEC 60670-22
- ugradnja s nožicama
- bez halogena

CONNECTION SQUARE BOX BRICK SM105x105

- size 105x105mm, depth 50mm
- cutting hole according to attached template
- 850°C, 400V ~
- in accordance with IEC 60670-1 and IEC 60670-22
- mounting with claws
- halogen free

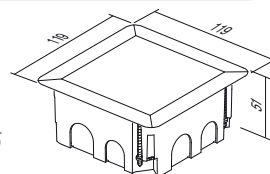

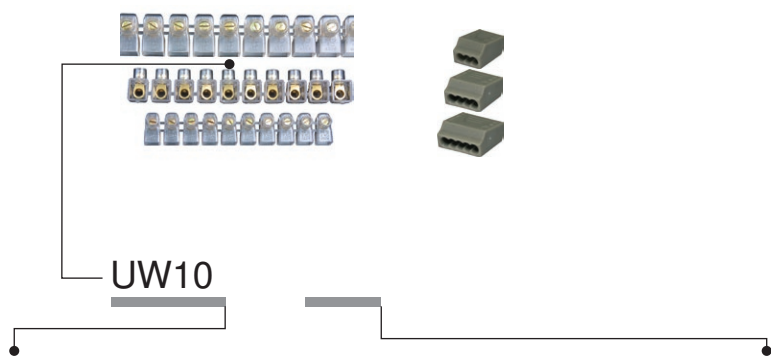

tip type	naziv description	tehnički podaci technical data	veličina size	boja colour
UW10	JEDNOREDNE STEZALJKE 1 ROW TERMINAL BLOCKS	2x2.5mm ²	10P	<input checked="" type="checkbox"/> TS transparentna transparent
UW11	JEDNOREDNE STEZALJKE 1 ROW TERMINAL BLOCKS	2x4mm ²	10P	<input checked="" type="checkbox"/> CO boja colour
UW12	JEDNOREDNE STEZALJKE 1 ROW TERMINAL BLOCKS	2x6mm ²	10P	<input type="checkbox"/> WH bijela white
·	·	·	·	<input type="checkbox"/> GY siva grey

JEDNOREDNE STEZALJKE ZATVORENE



- 450V~; 2x2.5mm² ÷ 2x6mm²
- termoplast PC, prozime
- broj polova: 10

1 ROW TERMINAL BLOCKS CLOSED

- 450V~; 2x2.5mm² ÷ 2x6mm²
- thermoplast PC, transparent
- number of poles: 10

UW10TS	(NS12)	2x2.5mm ²	10P
UW11TS	(NS12)	2x4mm ²	10P
UW12TS	(NS12)	2x6mm ²	10P

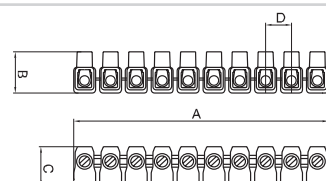

	A	B	C	D
2x2.5 □	110	17.5	17.5	11
2x4 □	128	21	19	12.5
2x6 □	146	21.5	22	15

JEDNOREDNE STEZALJKE

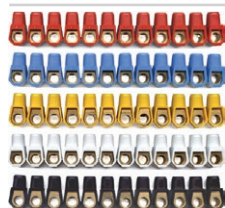

- 450V~; 2x2.5mm² ÷ 2x6mm²
- termoplast PA
- dostupne u raznim bojama
- broj polova: 12

1 ROW TERMINAL BLOCKS

- 450V~; 2x2.5mm² ÷ 2x6mm²
- thermoplast PA
- available in different colours
- number of poles: 12

UW15CO	(NS12)	2x2.5mm ²	12P
UW16CO	(NS12)	2x4mm ²	12P
UW17CO	(NS12)	2x6mm ²	12P

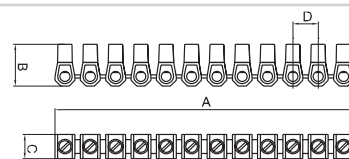

	A	B	C	D
2x2.5 □	110	16.4	9	10
2x4 □	118.8	19	10	10
2x6 □	129.8	21.3	11	11.8

DVOREDNE STEZALJKE PP

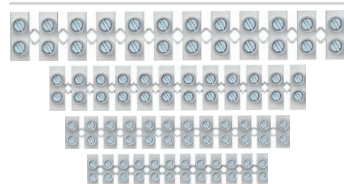

- 450 V~; 1 mm² ÷ 16 mm²
- termoplast polipropilen PP, bijele
- za upotrebu do 80 °C
- broj polova: 12

2 ROW TERMINAL BLOCKS PP

- 450V~; 1mm² ÷ 16mm²
- thermoplast polypropylene PP, white
- for temperatures up to 80°C
- number of poles: 12

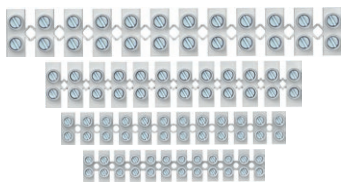

					A	B	C	D	E
UW29WHPP	1.0-4.0mm ²	24 A	450 V		94,9	13	16,6	8,1	6,4
UW30WHPP	1.5-6.0mm ²	32 A	450 V		116,5	14,9	18,9	10	7,3
UW31WHPP	2.5-10mm ²	41 A	450 V		133,8	17,3	23,4	11,5	10
UW32WHPP	4-16mm ²	76 A	450 V		174,5	20,7	25	15	11

**DVOREDNE STEZALJKE PA**

- 450 V~; 1 mm² ÷ 16 mm²
- termoplast poliamid PA, bijele
- za upotrebu do 110 °C
- broj polova: 12

2 ROW TERMINAL BLOCKS PA

- 450V~; 1mm² ÷ 16mm²
- thermoplast polyamide PA, white
- for temperatures up to 110°C
- number of poles: 12

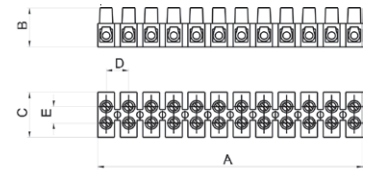

					A	B	C	D	E
UW25WHPA	1.0-4.0mm ²	24 A	450 V		93,6	13,4	16,2	8	6,4
UW26WHPA	1.5-6.0mm ²	32 A	450 V		117	15	18,6	10	7,3
UW27WHPA	2.5-10mm ²	41 A	450 V		132,8	17,3	22,2	11,5	10
UW28WHPA	4-16mm ²	76 A	450 V		173,9	20,8	25,2	15	11

BEZVIJČANE REDNE STEZALJKE

- 24A 450V~, termoplast PA, sive
- broj polova: 3÷8
- bezvičani kontakti 0,5 ÷ 1,5 mm², za tvrde žice
- sukladno normi EN 60998-1

PLUG-IN WIRE CONNECTORS

- 24A 450V~, thermoplast PA, grey
- number of poles: 3÷8
- plug-in contacts 0.5÷1.5mm², for rigide wires
- in accordance with EN 60998-1

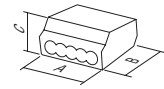

UW40GY	PC153	1.5mm ²	3P	3P	A 12	B 18	C 9
UW41GY	PC155	1.5mm ²	5P	5P	17	18	9
UW42GY	PC158	1.5mm ²	8P	8P	26	18	9

BEZVIJČANE REDNE STEZALJKE

- 24A 450V~, termoplast PA, sive
- broj polova: 3÷5
- bezvičani kontakti 1,5 ÷ 2,5 mm², za tvrde žice
- sukladno normi EN 60998-1

PLUG-IN WIRE CONNECTORS

- 24A 450V~, thermoplast PA, grey
- number of poles: 3÷5
- plug-in contacts 1.5÷2.5mm², for rigide wires
- in accordance with EN 60998-1

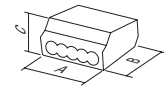

UW45GY	PC253	2.5mm ²	3P	3P	A 14	B 19	C 9
UW46GY	PC254	2.5mm ²	4P	4P	17	19	9
UW47GY	PC255	2.5mm ²	5P	5P	21	19	9

BEZVIJČANE REDNE STEZALJKE

- 24A 450V~, termoplast PA, sive
- broj polova: 2 (tvrda žica) + 1 (meka žica)
- bezvičani kontakti 1,5 ÷ 2,5mm²
- sukladno normi EN 60998-1

PLUG-IN WIRE CONNECTOR

- 24A 450V~, thermoplast PA, grey
- number of poles: 2 (rigide wire)+1 (soft wire)
- plug-in contacts 1.5÷2.5mm²
- in accordance with EN 60998-1

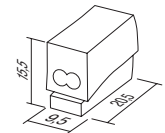

UW50WH	PC302	2.5mm ²	2/1P				
--------	-------	--------------------	------	--	--	--	--



MODUL
PURE

132

133

135

140

DISTRIBUCIJA



TEM

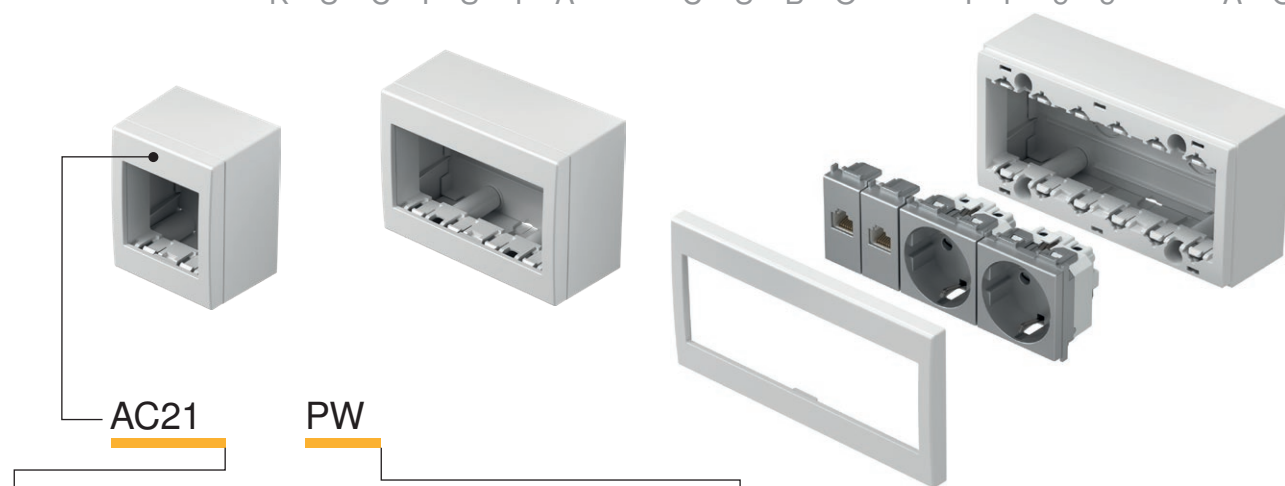

tip type	naziv description	tehnički podaci technical data	veličina size	boja colour
AC11	NADŽBUKNA KUTIJA SA STRAŽNJIM POKLOPCEM SURFACE MOUNT BOX WITH BACK SIDE COVER	IP20	1M	<input type="checkbox"/> PW bijela sjajna polar white <input type="checkbox"/> ES srebrna mat elox silver <input type="checkbox"/> IW bež sjajna ivory white
AC21	NADŽBUKNA KUTIJA SA STRAŽNJIM POKLOPCEM SURFACE MOUNT BOX WITH BACK SIDE COVER	IP20	2M	<input type="checkbox"/> PW bijela sjajna polar white <input type="checkbox"/> ES srebrna mat elox silver <input type="checkbox"/> IW bež sjajna ivory white
AC41	NADŽBUKNA KUTIJA SA STRAŽNJIM POKLOPCEM SURFACE MOUNT BOX WITH BACK SIDE COVER	IP20	4M	<input type="checkbox"/> PW bijela sjajna polar white <input type="checkbox"/> ES srebrna mat elox silver <input type="checkbox"/> IW bež sjajna ivory white

KUTIJA NO CUBO SA STRAŽNJIM POKLOPCEM IP20 1M



- AC11PW
- AC11ES
- AC11IW

- kutija IP20 1M
- za nadžbukno pričvršćivanje elemenata
- prikladno za SM sklopke
- sukladno normi EN 60669-1

BOX NO CUBO WITH BACK SIDE COVER IP20 1M

- box IP20 1M
- for surface mounting of elements
- suitable to SM switches
- in accordance with EN 60669-1



KUTIJA NO CUBO SA STRAŽNJIM POKLOPCEM IP20 2M



- AC21PW
- AC21ES
- AC21IW

- kutija IP20 2M
- za nadžbukno pričvršćivanje elemenata
- sukladno normama EN 60669-1, EN60884-1

BOX NO CUBO WITH BACK SIDE COVER IP20 2M

- box IP20 2M
- for surface mounting of elements
- in accordance with EN 60669-1, EN60884-1



KUTIJA NO CUBO SA STRAŽNJIM POKLOPCEM IP20 4M



- AC41PW
- AC41ES
- AC41IW

- kutija IP20 4M
- za nadžbukno pričvršćivanje elemenata
- sukladno normama EN 60669-1, EN60884-1

BOX NO CUBO WITH BACK SIDE COVER IP20 4M

- box IP20 4M
- for surface mounting of elements
- in accordance with EN 60669-1, EN60884-1



KUTIJA NO CUBO SA STRAŽNJIM POKLOPCEM IP20 6M



- AC61PW
- AC61ES
- AC61IW

- kutija IP20 6M
- za nadžbukno pričvršćivanje elemenata
- sukladno normama EN 60669-1, EN60884-1

BOX NO CUBO WITH BACK SIDE COVER IP20 6M

- box IP20 6M
- for surface mounting of elements
- in accordance with EN 60669-1, EN60884-1

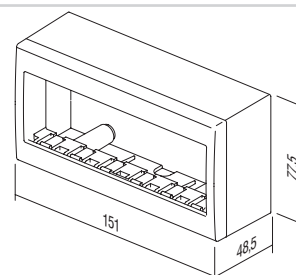
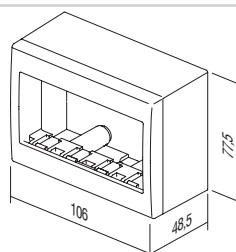
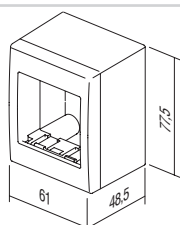
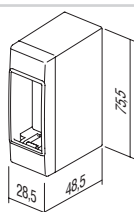

B O X E S C U B O I P 5 5 A Q



AQ30

PW

tip type	naziv description	tehnički podaci technical data	veličina size	boja colour
AQ20	VANJSKA NADŽBUKNA KUTIJA OUTDOOR SURFACE MOUNT BOX	IP55	2M	<input type="checkbox"/> PW bijela sjajna polar white
AQ22	VANJSKA NADŽBUKNA KUTIJA OUTDOOR SURFACE MOUNT BOX	IP55	2x2M	<input type="checkbox"/> GY siva grey
AQ30	VANJSKA NADŽBUKNA KUTIJA OUTDOOR SURFACE MOUNT BOX	IP55	3M	
AQ31	VANJSKA NADŽBUKNA KUTIJA OUTDOOR SURFACE MOUNT BOX	IP55	3M	

KUTIJA NO CUBO IP55 2M



- AQ20PW
 AQ20GY

- kutija IP55 2M
- za nadžbukno pričvršćivanje
- IP55 za ugradnju u vlažnom prostoru
- sukladno normama CEI 23-48, EN 60670

BOX NO CUBO IP55 2M

- box IP55 2M
- for surface mounting
- IP55 for usage in humid areas
- in accordance with CEI 23-48, EN 60670



KUTIJA NO CUBO IP55 2x2M



- AQ22PW
 AQ22GY

- kutija IP55 2x2M
- za nadžbukno pričvršćivanje
- IP55 za ugradnju u vlažnom prostoru
- sukladno normama CEI 23-48, EN 60670

BOX NO CUBO IP55 2x2M

- box IP55 2x2M
- for surface mounting
- IP55 for usage in humid areas
- in accordance with CEI 23-48, EN 60670



KUTIJA NO CUBO IP55 3M



- AQ30PW
 AQ30GY

- kutija IP55 3M
- za nadžbukno pričvršćivanje
- IP55 za ugradnju u vlažnom prostoru
- sukladno normama CEI 23-48, EN 60670

BOX NO CUBO IP55 3M

- box IP55 3M
- for surface mounting
- IP55 for usage in humid areas
- in accordance with CEI 23-48, EN 60670



KUTIJA PO CUBO IP55 2M



- AQ21PW
- AQ21AT

- kutija IP55 2M
- moguće kombinacije sa svim funkcijskim elementima Modul
- za podžbukno pričvršćivanje
- IP55 za ugradnju u vlažnom prostoru
- sukladno normama CEI 23-48, EN 60670



BOX PO CUBO IP55 2M

- box IP55 2M
- can be combined with all Modul functional elements
- for flush mounting
- IP55 for usage in humid areas
- in accordance with CEI 23-48, EN 60670

KUTIJA PO CUBO IP55 3M



- AQ31PW
- AQ31GY

- kutija IP55 3M
- za podžbukno pričvršćivanje
- IP55 za ugradnju u vlažnom prostoru
- sukladno normama CEI 23-48, EN 60670



BOX PO CUBO IP55 3M

- box IP55 3M
- for flush mounting
- IP55 for usage in humid areas
- in accordance with CEI 23-48, EN 60670

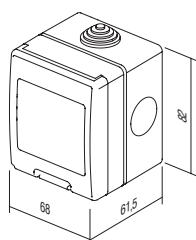

AQ20

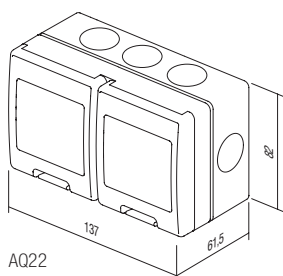

AQ22

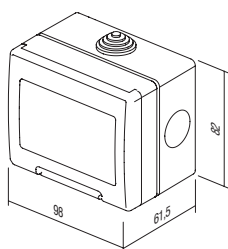

AQ30

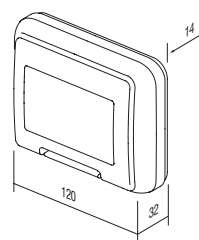

AQ31

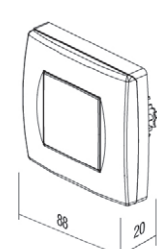

AQ21

TRUNKING SYSTEM ALUMINIUM

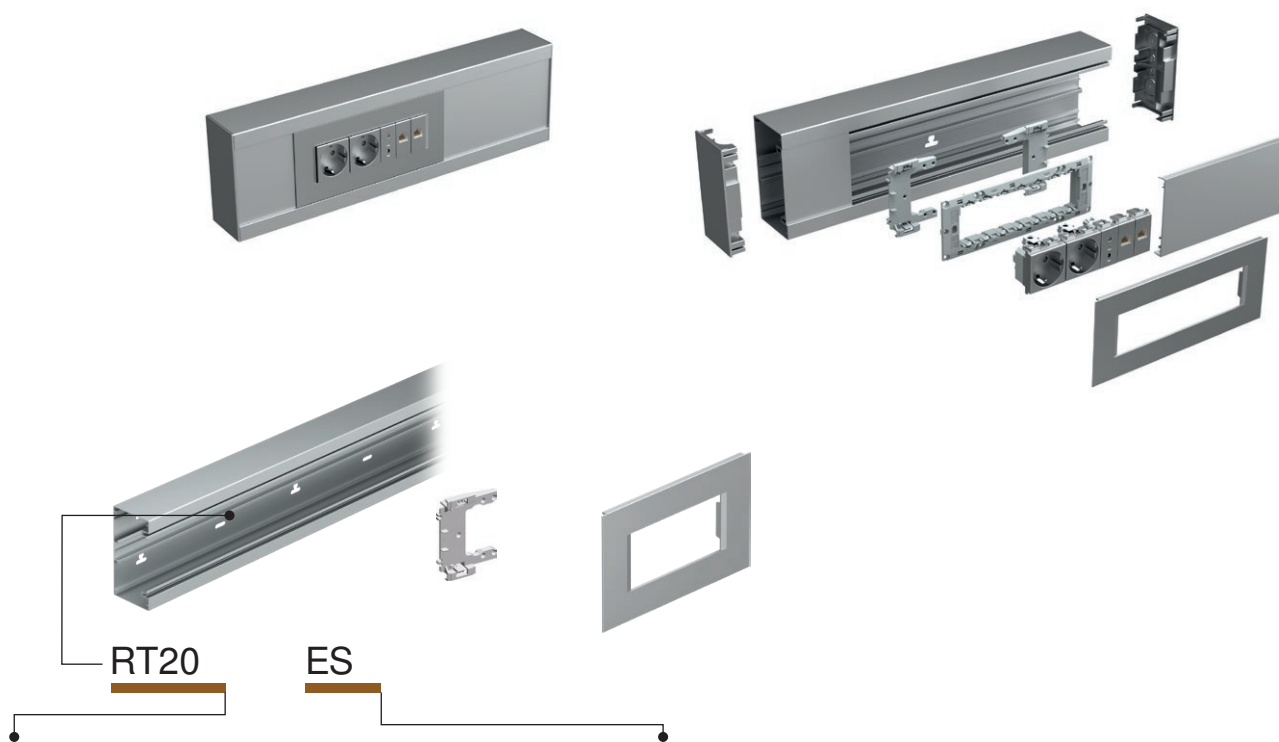

tip type	naziv description	veličina size	boja colour
RT10	ADAPTER MA 92 ADAPTER MA 92	/	■ ES srebrna mat elox silver-mat
RT12	POKLOPAC MA 92 COVER PLATE MA 92	2/3M	□ PW bijela mat (RAL 9016) white-mat
RT14	POKLOPAC MA 92 COVER PLATE MA 92	4M	
⋮	⋮	⋮	
⋮	⋮	⋮	

ADAPTER MA 92



RT10

- adapter za pričvršćivanje nosača 2/3M, 4M ili 7M na kanal MA bez kutije
- za svaki su nosač potrebna dva adaptera
- sukladno normi EN 50085-1

ADAPTER MA 92

- adapter for fixing mounting frames 2/3M, 4M or 7M on MA trunking without box
- each mounting frame needs two adapters
- in accordance with EN 50085-1

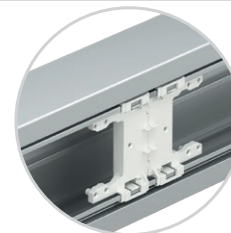

POKLOPAC MA 92 2/3M



■ RT12ES
□ RT12PW

- dekorativni poklopac MA 2/3M
- sukladno normi EN 50085-1

COVER PLATE MA 92 2/3M

- decorative cover plate MA 2/3M
- in accordance with EN 50085-1

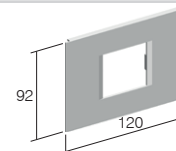

POKLOPAC MA 92 4M



■ RT14ES
□ RT14PW

- dekorativni poklopac MA 4M
- sukladno normi EN 50085-1

COVER PLATE MA 92 4M

- decorative cover plate MA 4M
- in accordance with EN 50085-1

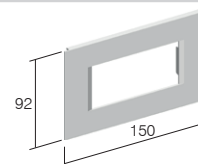

POKLOPAC MA 92 7M



■ RT17ES
□ RT17PW

- dekorativni poklopac MA 7M
- sukladno normi EN 50085-1

COVER PLATE MA 92 7M

- decorative cover plate MA 7M
- in accordance with EN 50085-1

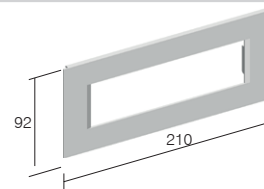

OSNOVA KANALA MA 130x65



- RT20ES
- RT20PW

- osnova kanala od ekstrudiranog aluminija
- visina 130 mm, duljina 2 m
- DIN tračnica 35 mm na dnu
- sukladno normi EN 50085-1

TRUNKING BASE MA 130x65

- trunking base from extruded aluminium
- height 130mm, length 2m
- DIN - rail 35mm shape on bottom
- in accordance with EN 50085-1

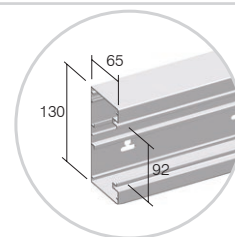

OSNOVA KANALA MA 165x65



- RT21ES
- RT21PW

- osnova kanala od ekstrudiranog aluminija
- visina 165mm, duljina 2 m
- DIN tračnica 35 mm na dnu
- sukladno normi EN 50085-1

TRUNKING BASE MA 165x65

- trunking base from extruded aluminium
- height 165mm, length 2m
- DIN - rail 35mm shape on bottom
- in accordance with EN 50085-1

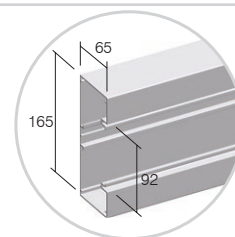

POKLOPAC KANALA MA 92

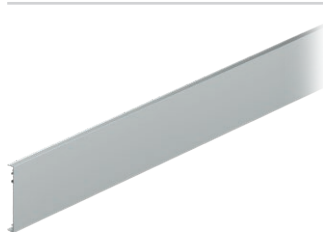

- RT25ES
- RT25PW

- poklopac kanala od ekstrudiranog aluminija
- visina 92mm, duljina 2 m
- sukladno normi EN 50085-1

FRONT COVER MA 92

- front cover from extruded aluminium
- height 92mm, length 2m
- in accordance with EN 50085-1

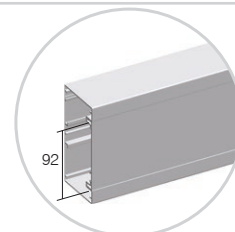

PREGRADA MA 43



RT30

- pregrada od ekstrudiranog polimera
- dubina 43 mm, duljina 2 m
- sukladno normi EN 50085-1

CABLE SHELF MA 43

- cable shelf from extruded polymer
- depth 43mm, length 2m
- in accordance with EN 50085-1

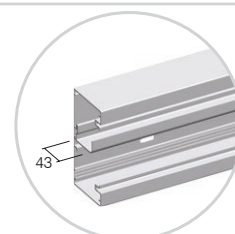

PREGRADA MA 43 AL



RT31

- pregrada od ekstrudiranog aluminija
- dubina 43 mm, duljina 2 m
- sukladno normi EN 50085-1

CABLE SHELF MA 43 AL

- cable shelf from extruded aluminium
- depth 43mm, length 2m
- in accordance with EN 50085-1

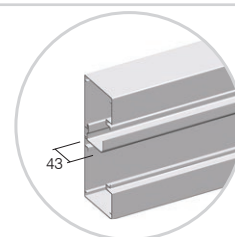

PREGRADA MA 43 AL DVOSTRUKA



RT32

- dvostruka pregrada od ekstrudiranog aluminija
- dubina 43 mm, duljina 2 m
- sukladno normi EN 50085-1

CABLE SHELF MA 43 AL DOUBLE

- double cable shelf from extruded aluminium
- depth 43mm, length 2m
- in accordance with EN 50085-1

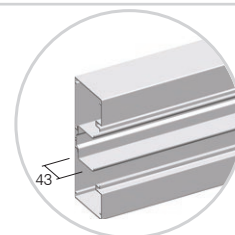

T R U N K I N G S Y S T E M A L U M I N I U M

ZAVRŠNI ELEMENT MA 130x65



- RT35ES
- RT35PW

- završni element od polimera
- visina 130mm
- sukladno normi EN 50085-1

STOP END MA 130x65

- stop end element from polymer
- height 130mm
- in accordance with EN 50085-1

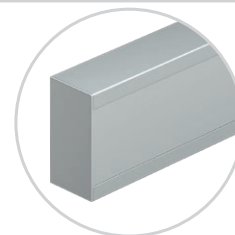

ZAVRŠNI ELEMENT MA 165x65



- RT36ES
- RT36PW

- završni element od metala
- visina 165mm
- sukladno normi EN 50085-1

STOP END MA 165x65

- stop end element from metal
- height 165mm
- in accordance with EN 50085-1

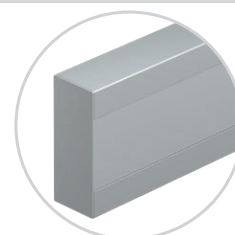

SET SPOJNI ELEMENT MA 65



RT38

- spojni element od polimera
- set sadrži 2 spojna elementa i vijke
- sukladno normi EN 50085-1

SET JOINING PIECE MA 65

- joining piece from polymer
- set contains two pieces and screws
- in accordance with EN 50085-1

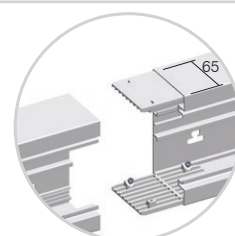

UNIVERZALNI KUT MA 130x65



- RT40ES
- RT40PW

- univerzalni kutni element
- visina 130mm
- sukladno normi EN 50085-1

UNIVERSAL CORNER MA 130x65

- universal corner element
- height 130mm
- in accordance with EN 50085-1



UNIVERZALNI KUT MA 165x65



- RT41ES
- RT41PW

- univerzalni kutni element
- visina 165mm
- sukladno normi EN 50085-1

UNIVERSAL CORNER MA 165x65

- universal corner element
- height 165mm
- in accordance with EN 50085-1

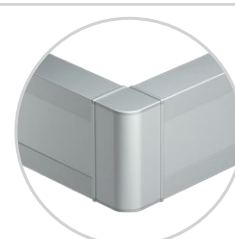

ELEMENT ZA UZEMLJENJE MA 2x A6.3



RT42

- element za uzemljenje osnove kanala i poklopca
- sukladno normi EN 50085-1

EARTHING PIECE MA 2x A6.3

- earthing piece for earthing of trunking base and front cover
- in accordance with EN 50085-1

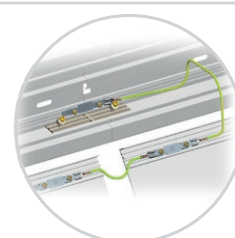

L-KOMAD ELEMENT MA 130x65



- RT43ES
- RT43PW

- univerzalni L-komad od aluminija
- visina 130 mm, duljina 400mm
- sukladno normi EN 50085-1

L-BEND MA 130x65

- universal L bend element from aluminium
- height 130mm, length 400mm
- in accordance with EN 50085-1

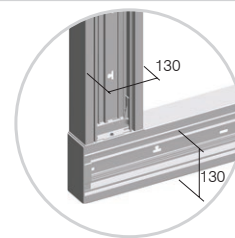

L-KOMAD ELEMENT MA 165x65



- RT44ES
- RT44PW

- univerzalni L-komad od aluminija
- visina 165mm, duljina 400mm
- za povezivanje na MA 130x65
- sukladno normi EN 50085-1

L-BEND MA 165x65

- universal L bend element from aluminium
- height 165mm, length 400mm
- connection on MA 130x65
- in accordance with EN 50085-1

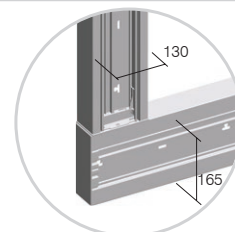

T-KOMAD MA 130x65



- RT45ES
- RT45PW

- univerzalni T-komad od aluminija
- visina 130 mm, duljina 400mm
- sukladno normi EN 50085-1

T-BEND MA 130x65

- universal T bend element from aluminium
- height 130mm, length 400mm
- in accordance with EN 50085-1

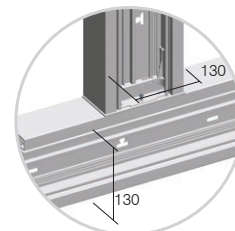

T-KOMAD MA 165x65

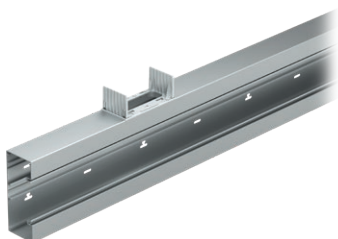

- RT46ES
- RT46PW

- univerzalni T-komad od aluminija
- visina 165mm, duljina 400mm
- za povezivanje na MA 130x65
- sukladno normi EN 50085-1

T-BEND MA 165x65

- universal T bend element from aluminium
- height 165mm, length 400mm
- connection on MA 130x65
- in accordance with EN 50085-1

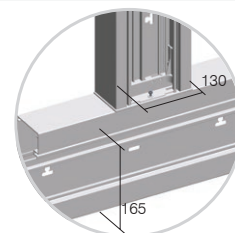

MA parapetni kanali temelje se na modularnom sustavu s kombinacijama elemenata veličine 2M, 4M ili 7M

MA trunking is based on modular system making 2M, 4M or 7M combinations of elements

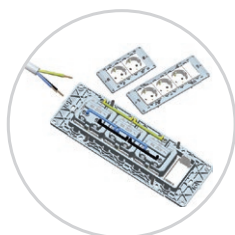

Modul sadrži specijalne elemente pripremljene za brzu instalaciju

In Modul we provide special elements for quick installation

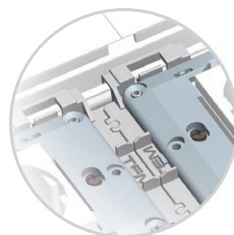

Adapter MA omogućuje točno postavljanje bez dodatnog napora

With Adapter MA exact positioning without extra effort is provided

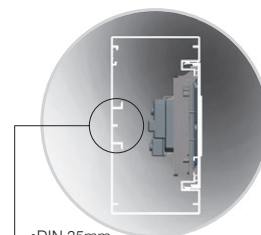

Montaža bez kutije znači više prostora za kablove, DIN tračnica ima oblik sukladan normi EN 60715

Mounted without box means more space for cables, DIN-rail base shape EN-60715

T R U N K I N G S Y S T E M A L U M I N I U M



NOSAČ STUPIČA MA JEDNOSTRUKI 130x65



- RT50ES
- RT50PW

- nosač za pričvršćivanje kanala MA130 na podu i/ili na stropu
- sukladno normi EN 50085-1

FIXING PLATE MA SINGLE 130x65

- fixing plate for fixing trunking base MA130 on the floor and/or on the ceiling
- in accordance with EN 50085-1



- RT51ES
- RT51PW

NOSAČ STUPIČA MA DVOSTRUKI 130x65

- nosač za pričvršćivanje dva kanala MA130 na podu i/ili na stropu
- sukladno normi EN 50085-1

FIXING PLATE MA DOUBLE 130x65

- fixing plate for fixing two trunking bases MA130 on the floor and/or on the ceiling
- in accordance with EN 50085-1



STUPIĆ MA 130x65x500



- RT52ES
- RT52PW

- stupić MA
- visina 500mm
- nosač 7M ugrađen
- sukladno normi EN 50085-1

SERVICE POST MA 130x65x500

- service post MA
- height 500mm
- mounting frame 7M included
- in accordance with EN 50085-1



STUPIĆ MA DVOSTRUKI 130x130x500

- RT53ES
- RT53PW

- stupić MA dvostruki
- visina 500mm
- nosači 7M ugrađeni
- sukladno normi EN 50085-1

SERVICE POST MA DOUBLE 130x130x500

- service post MA double
- height 500mm
- mounting frames 7M included
- in accordance with EN 50085-1

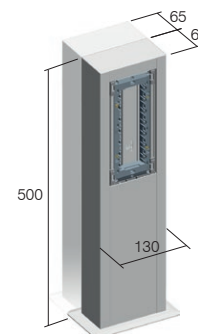

Cable intersection mm ²	Poprečni presjek vodiča / Cable cross-section (mm ²)				
	1 vodič / 1 wire	2 vodiča / 2 wires	3 vodiča / 3 wires	4 vodiča / 4 wires	5 vodiča / 5 wires
1,5	44	111	121	144	169
2,5	49	133	157	169	211
4	58	169	183	211	256
6	68	196	225	256	307

Kapacitet parapetnog kanala / Trunk capacity				
Kanal / Trunk	MA 130x65 prazan / empty	MA 130x65 s Modul sklopkama i utičnicama / with Modul switches and sockets	MA 165x65 prazan / empty	MA 130x65 s Modul sklopkama i utičnicama / with Modul switches and sockets
kapaciteta capacity	7600 mm ²	5500 mm ²	9900 mm ²	7800 mm ²
max ø	54 mm	2x42 mm	54 mm	2x42 mm

A R A P E T N I K A N A L I M T

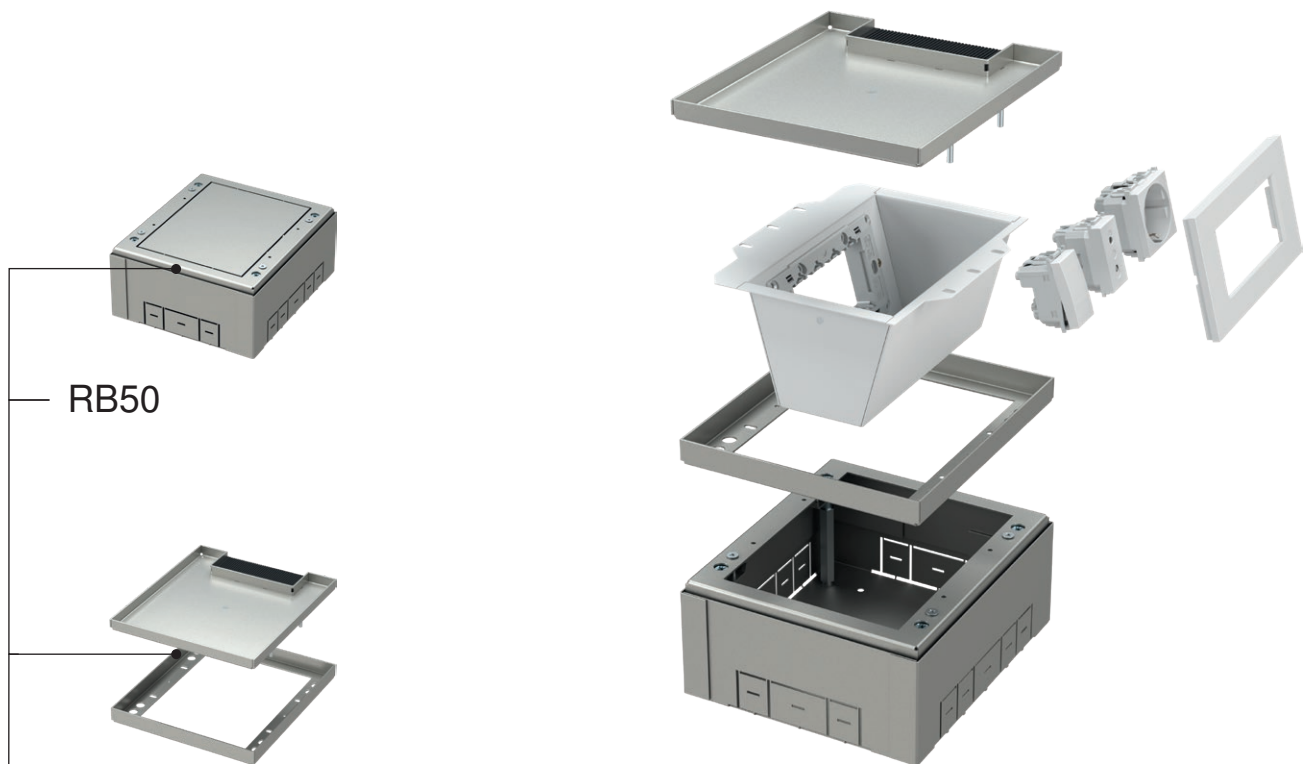

RB50

RB65S1

tip type	naziv description	tehnički podaci technical data
RB50	UGRADNO KUĆIŠTE PODNE KUTIJE FLOOR BOX BASE	4M
RB65S1	POKLOPAC PODNE KUTIJE FLOOR DISTRIBUTION BOX COVER	4M
RB60	UMETAK PODNE KUTIJE INSERT FOR FLOOR DISTIRBUTION BOX	4M
·	·	·
·	·	·

	RB65S1	RB66S1	RB67S2	RB68S2
X	177	178	265	516,5
Y	200,5	265	265	265
Z	17,5	17,5	17,5	17,5

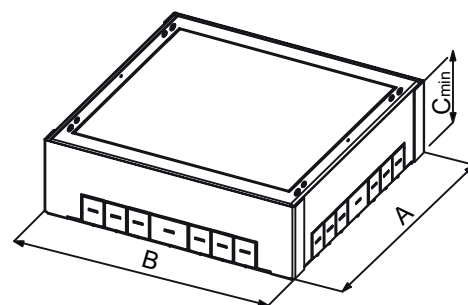
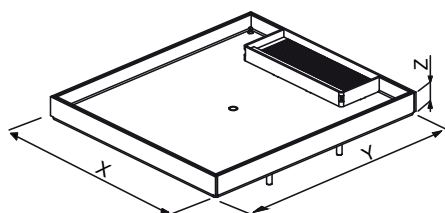

	RB50	RB51	RB52	RB53
A	208,5	273	273	273
B	182	182,5	269,5	521
C	83	83	83	83

F L O O R B O X E S M T

UGRADNO KUĆIŠTE PODNE KUTIJE 4M



RB50

- ugradno kućište 4M
- metalno, galvanizirano
- za ugradnju u pod ili dvostruki pod
- ugradne dimenzije 208,5 x 182 mm, dubina min. 83 mm
- prilagodljiva visina 83 – 128 mm
- Sukladno normama EN 5005-1 i EN 50085-2-2

FLOOR BOX BASE 4M

- floor box base 4M
- metal, galvanized
- for installation in a floor or double floor
- mounting dimensions 208.5x182mm, min. depth 83mm
- adjustable height 83-128mm
- In accordance with EN 5005-1 and EN 50085-2-2

UMETAK PODNE KUTIJE 4M



RB60

- Umetak podne kutije 4M
- Metalni, bijela boja RAL 9006
- Nosač MODUL 4M ugrađen
- Sukladno normama EN 5005-1 i EN 50085-2-2

INSERT FOR FLOOR DISTRIBUTION BOX 4M

- insert for floor box 4M
- metal, colour white RAL 9006
- mounting frame MODUL 4M included
- in accordance with EN 5005-1 and EN 50085-2-2

POKLOPAC PODNE KUTIJE 4M



RB65S1

- Poklopac kutije 4M
- Metalni, galvaniziran
- Ugradne dimenzije 200,5 x 177 mm, dubina min. 17,5 mm
- Debljina podne obloge poklopca do 11,5 mm
- Sukladno normama EN 5005-1 i EN 50085-2-2

FLOOR DISTRIBUTION BOX COVER 4M

- floor box cover 4M
- metal, galvanized
- mounting dimensions 200.5x177mm, depth 17.5mm
- floor thickness up to 11.5mm
- in accordance with EN 5005-1 and EN 50085-2-2

UGRADNO KUĆIŠTE PODNE KUTIJE 7M



RB51

- Ugradno kućište 7M
- Metalno, galvanizirano
- Za ugradnju u pod ili dvostruki pod
- Ugradne dimenzije 273 x 182,5 mm, dubina min. 83 mm
- Prilagodljiva visina 83 – 128 mm
- Sukladno normama EN 5005-1 i EN 50085-2-2

FLOOR BOX BASE 7M

- floor box base 7M
- metal, galvanized
- for installation in a floor or double floor
- mounting dimensions 273x182.5mm, min. depth 83mm
- adjustable height 83-128mm
- in accordance with EN 5005-1 and EN 50085-2-2

UMETAK PODNE KUTIJE 7M



RB61

- Umetak podne kutije 7M
- Metalni, bijela boja RAL 9006
- Nosač MODUL 7M ugrađen
- Sukladno normama EN 5005-1 i EN 50085-2-2

INSERT FOR FLOOR DISTRIBUTION BOX 7M

- insert for floor box 7M
- metal, colour white RAL 9006
- mounting frame MODUL 7M included
- in accordance with EN 5005-1 and EN 50085-2-2

POKLOPAC PODNE KUTIJE 7M



RB66S1

- Poklopac kutije 7M
- Metalni, galvaniziran
- Ugradne dimenzije 265 x 178 mm, dubina min. 17,5 mm
- Debljina podne obloge poklopca do 11,5 mm
- Sukladno normama EN 5005-1 i EN 50085-2-2

FLOOR DISTRIBUTION BOX COVER 7M

- floor box cover 7M
- metal, galvanized
- mounting dimensions 265x178mm, depth 17.5mm
- floor thickness up to 11.5mm
- in accordance with EN 5005-1 and EN 50085-2-2

UGRADNO KUĆIŠTE PODNE KUTIJE 2X7M

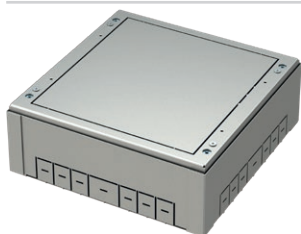

RB52

- Ugradno kućište 2X7M
- Metalno, galvanizirano
- Za ugradnju u pod ili dvostruki pod
- Ugradne dimenzije 273 x 269,5 mm, dubina min. 83 mm
- Prilagodljiva visina 83 – 128 mm
- Sukladno normama EN 5005-1 i EN 50085-2-2

FLOOR BOX BASE 2X7M

- floor box base 2X7M
- metal, galvanized
- for installation in a floor or double floor
- mounting dimensions 273x269.5mm, min. depth 83mm
- adjustable height 83-128mm
- in accordance with EN 5005-1 and EN 50085-2-2

UMETAK PODNE KUTIJE 2X7M

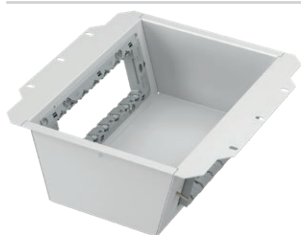

RB62

- Umetak podne kutije 2x7M
- Metalni, bijela boja RAL 9006
- Nosači MODUL 7Mx2 ugrađeni
- Sukladno normama EN 5005-1 i EN 50085-2-2

INSERT FOR FLOOR DISTRIBUTION BOX 2X7M

- insert for floor box 2x7M
- metal, colour white RAL 9006
- mounting frames MODUL 2x7M included
- in accordance with EN 5005-1 and EN 50085-2-2

POKLOPAC PODNE KUTIJE 2X7M



RB67S2

- Poklopac kutije 2X7M
- Metalni, galvaniziran
- Ugradne dimenzije 265 x 265 mm, dubina min. 17,5 mm
- Debljina podne obloge poklopca do 11,5 mm
- Sukladno normama EN 5005-1 i EN 50085-2-2

FLOOR DISTRIBUTION BOX COVER 2X7M

- floor box cover 2x7M
- metal, galvanized
- mounting dimensions 265x265mm, depth 17.5mm
- floor thickness up to 11.5mm
- in accordance with EN 5005-1 and EN 50085-2-2

UGRADNO KUĆIŠTE PODNE KUTIJE 4X7M

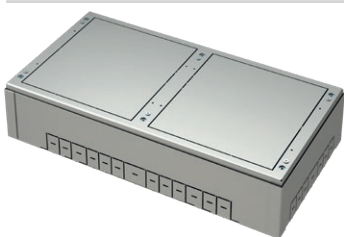

RB53

- Ugradno kućište 4x7M
- Metalno, galvanizirano
- Za ugradnju u pod ili dvostruki pod
- Ugradne dimenzije 273 x 521 mm, dubina min. 83 mm
- Prilagodljiva visina 83 – 128 mm
- Sukladno normama EN 5005-1 i EN 50085-2-2

FLOOR BOX BASE 4X7M

- floor box base 4X7M
- metal, galvanized
- for installation in a floor or double floor
- mounting dimensions 273x521mm, min. depth 83mm
- adjustable height 83-128mm
- in accordance with EN 5005-1 and EN 50085-2-2

UMETAK PODNE KUTIJE 2X7M

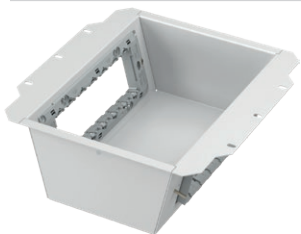

RB62

- Umetak podne kutije 2x7M
- Metalni, bijela boja RAL 9006
- Nosači MODUL 7Mx2 ugrađeni
- Sukladno normama EN 5005-1 i EN 50085-2-2

INSERT FOR FLOOR DISTRIBUTION BOX 2X7M

- insert for floor box 2x7M
- metal, colour white RAL 9006
- mounting frames MODUL 2x7M included
- in accordance with EN 5005-1 and EN 50085-2-2

POKLOPAC PODNE KUTIJE 4X7M



RB68S2

- Poklopac kutije 4X7M
- Metalni, galvaniziran
- Ugradne dimenzije 265 x 516,5 mm, dubina min. 17,5 mm
- Debljina podne obloge poklopca do 11,5 mm
- Sukladno normama EN 5005-1 i EN 50085-2-2

FLOOR DISTRIBUTION BOX COVER 4X7M

- floor box cover 4x7M
- metal, galvanized
- mounting dimensions 265x516.5mm, depth 17.5mm
- floor thickness up to 11.5mm
- in accordance with EN 5005-1 and EN 50085-2-2



RB55S1

tip type	naziv description	tehnički podaci technical data
RB55S1	PODNA KUTIJA ZA DVOSTRUKE PODOVE S POKLOPCEM 4M FLOOR BOX WITH COVER FOR DOUBLE FLOORS	4M
RB60	UMETAK PODNE KUTIJE INSERT FOR FLOOR DISTRIBUTION BOX	4M
⋮	⋮	⋮
⋮	⋮	⋮

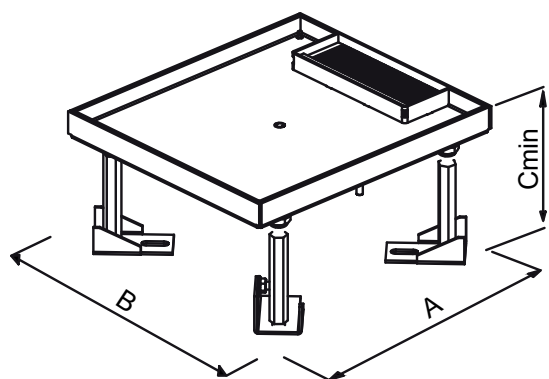

	RB55S1	RB56S1	RB57S2	RB58S2
A	200,5	265	265	265
B	177	178	265	516,5
C	100	100	100	100

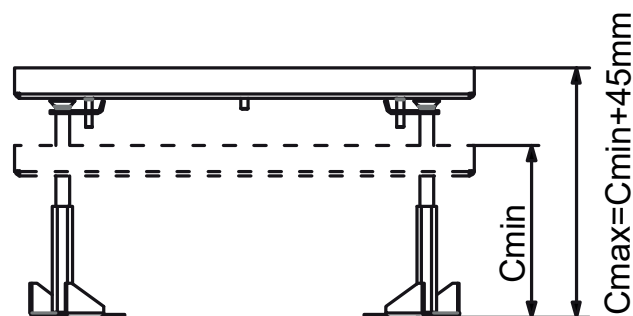

PODNA KUTIJA ZA DVOSTRUKE PODOVE S POKLOPCEM 4M



RB55S1

- Podna kutija za dvostruke podove 4M
- Metalna, galvanizirana
- Ugradne dimenzije 200,5 x 177 mm, dubina min. 100 mm
- Prilagodljiva visina 100 – 145 mm
- Debljina podne obloge poklopca do 11,5 mm
- Sukladno normama EN 5005-1 i EN 50085-2-2

FLOOR BOX WITH COVER FOR DOUBLE FLOORS 4M

- floor box base 4M
- metal, galvanized
- mounting dimensions 200.5x177mm, min. depth 100mm
- adjustable height 100-145mm
- floor thickness up to 11.5mm
- in accordance with EN 5005-1 and EN 50085-2-2

UMETAK PODNE KUTIJE 4M



RB60

- Umetak podne kutije 4M
- Metalni, bijela boja RAL 9006
- Nosač MODUL 4M ugrađen
- Sukladno normama EN 5005-1 i EN 50085-2-2

INSERT FOR FLOOR DISTRIBUTION BOX 4M

- insert for floor box 4M
- metal, colour white RAL 9006
- mounting frame MODUL 4M included
- in accordance with EN 5005-1 and EN 50085-2-2

PODNA KUTIJA ZA DVOSTRUKE PODOVE S POKLOPCEM 7M



RB56S1

- Podna kutija za dvostruke podove 7M
- Metalna, galvanizirana
- Ugradne dimenzije 265 x 178 mm, dubina min. 100 mm
- Prilagodljiva visina 100 – 145 mm
- Debljina podne obloge poklopca do 11,5 mm
- Sukladno normama EN 5005-1 i EN 50085-2-2

FLOOR BOX WITH COVER FOR DOUBLE FLOORS 7M

- floor box base 7M
- metal, galvanized
- mounting dimensions 265x178mm, min. depth 100mm
- adjustable height 100-145mm
- floor thickness up to 11.5mm
- in accordance with EN 5005-1 and EN 50085-2-2

UMETAK PODNE KUTIJE 7M



RB61

- Umetak podne kutije 7M
- Metalni, bijela boja RAL 9006
- Nosač MODUL 7M ugrađen
- Sukladno normama EN 5005-1 i EN 50085-2-2

INSERT FOR FLOOR DISTRIBUTION BOX 7M

- insert for floor box 7M
- metal, colour white RAL 9006
- mounting frame MODUL 7M included
- in accordance with EN 5005-1 and EN 50085-2-2

PODNA KUTIJA ZA DVOSTRUKE PODOVE S POKLOPCEM 2X7M



RB57S2

- Podna kutija za dvostruke podove 2x7M
- Metalna, galvanizirana
- Ugradne dimenzije 265 x 265 mm, dubina min. 100 mm
- Prilagodljiva visina 100 – 145 mm
- Debljina podne obloge poklopca do 11,5 mm
- Sukladno normama EN 5005-1 i EN 50085-2-2

FLOOR BOX WITH COVER FOR DOUBLE FLOORS 2X7M

- floor box base 2x7M
- metal, galvanized
- mounting dimensions 265x265mm, min. depth 100mm
- adjustable height 100-145mm
- floor thickness up to 11.5mm
- in accordance with EN 5005-1 and EN 50085-2-2

UMETAK PODNE KUTIJE 2X7M



RB62

- Umetak podne kutije 2x7M
- Metalni, bijela boja RAL 9006
- Nosači MODUL 7Mx2 ugrađeni
- Sukladno normama EN 5005-1 i EN 50085-2-2

INSERT FOR FLOOR DISTRIBUTION BOX 2X7M

- insert for floor box 2x7M
- metal, colour white RAL 9006
- mounting frames MODUL 2x7M included
- in accordance with EN 5005-1 and EN 50085-2-2

PODNA KUTIJA ZA DVOSTRUKE PODOVE S POKLOPCEM 4X7M



RB58S2

- Podna kutija za dvostruke podove 4x7M
- Metalna, galvanizirana
- Ugradne dimenzije 265 x 516,5 mm, dubina min. 100 mm
- Prilagodljiva visina 100 – 145 mm
- Debljina podne obloge poklopca do 11,5 mm
- Sukladno normama EN 5005-1 i EN 50085-2-2

FLOOR BOX WITH COVER FOR DOUBLE FLOORS 4X7M

- floor box base 4x7M
- metal, galvanized
- mounting dimensions 265x516.5mm, min. depth 100mm
- adjustable height 100-145mm
- floor thickness up to 11.5mm
- in accordance with EN 5005-1 and EN 50085-2-2

UMETAK PODNE KUTIJE 2X7M



RB62

- Umetak podne kutije 2x7M
- Metalni, bijela boja RAL 9006
- Nosači MODUL 7Mx2 ugrađeni
- Sukladno normama EN 5005-1 i EN 50085-2-2

INSERT FOR FLOOR DISTRIBUTION BOX 2X7M

- insert for floor box 2x7M
- metal, colour white RAL 9006
- mounting frames MODUL 2x7M included
- in accordance with EN 5005-1 and EN 50085-2-2

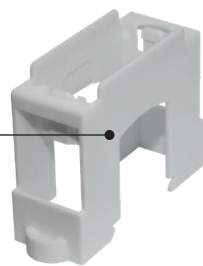
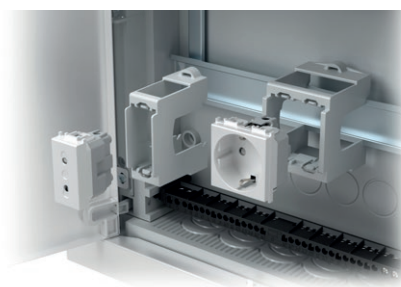
RB10

tip type	naziv description	tehnički podaci technical data
RB10	ADAPTER ZA DIN-TRAČNICU 35mm 1M <i>ADAPTER FOR DIN RAIL</i>	
RB11	ADAPTER ZA DIN-TRAČNICU 35mm 2M <i>ADAPTER FOR DIN RAIL</i>	
⋮	⋮	⋮

RB10
ADAPTER ZA DIN-TRAČNICU 35mm 1M

- adapter MODUL 1M
- za Din tračnicu 35 mm
- sukladno normi EN 50022

ADAPTER FOR DIN RAIL 35mm 1M

- adapter MODUL 1M
- for DIN rail 35mm
- in accordance with EN 50022

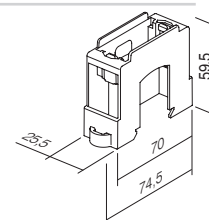
RB11
ADAPTER ZA DIN-TRAČNICU 35mm 2M

- adapter MODUL 2M
- za Din tračnicu 35 mm
- sukladno normi EN 50022

ADAPTER FOR DIN RAIL 35mm 2M

- adapter MODUL 2M
- for DIN rail 35mm
- in accordance with EN 50022

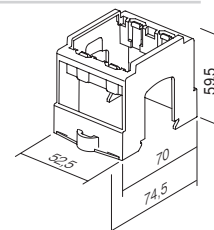

SWITCH
LOGIQ



TEM

LOGIQ

SVEPRISUTNO POUZDANJE **stvoreno za svaku prostoriju**

Oblik za svaku prostoriju. Sklopke imaju univerzalne linije koje ostavljaju jednako upečatljiv trag u modernim radnim prostorima kao i u udobnim prostorima za život. LOGIQ obitelj nudi jednostavno i logično rješenje za svaku Vašu želju.

OMNIPRESENT CONFIDENCE made for every room

A shape for every room. The switches have universal lines that leave a mark in both modern work environments as well as in cosy, comfortable living spaces. The LOGIQ family offers a simple and logical solution for your every wish.



LOGIQ

HARMONIJA BOJA **Odaberite svoju nijansu**

LOGIQ obitelj ponosno predstavlja seriju provjerenih i elegantnih nijansi koje naši klijenti poznaju i obožavaju. Nemojte pristati na kompromise, LOGIQ obitelj ima sve što vam treba. Uvijek možemo kreirati nijansu prema Vašim posebnim željama. Logično.

HARMONY OF COLOURS Choose your hue

The LOGIQ family prides itself on its logical range of verified and elegant hues known and loved by our clients. Don't compromise, the LOGIQ family has you covered. We can always create the hue of colour in accordance with your special request. Logically.

- **antracit** *anthracite*
- **titan** *titanium*
- **bijela sjajna** *polar white*



NEOGRANIČENA MAŠTA **Kreirajte svoju vlastitu kombinaciju**

LOGIQ obitelj omogućuje vam da kreirate svoju vlastitu kombinaciju. Kako bismo Vam olakšali kombiniranje, kreirali smo učinkovit sustav koji podržava slaganje horizontalnih i vertikalnih linija. Takozvani 55/55 sustav omogućuje Vam da se svaki put koristite istim elementima. Znae što želite? Bez brige, LOGIQ sklopke čitaju Vam misli.

LIMITLESS IMAGINATION Create your own combination

The LOGIQ family allows you to create your own combination. To make combining simple, we have created a useful system that supports the sequencing of horizontal and vertical lines. The so-called 55/55 system allows you to use the same universal elements every time. Know what you want? Don't worry, the LOGIQ switches can read your mind.



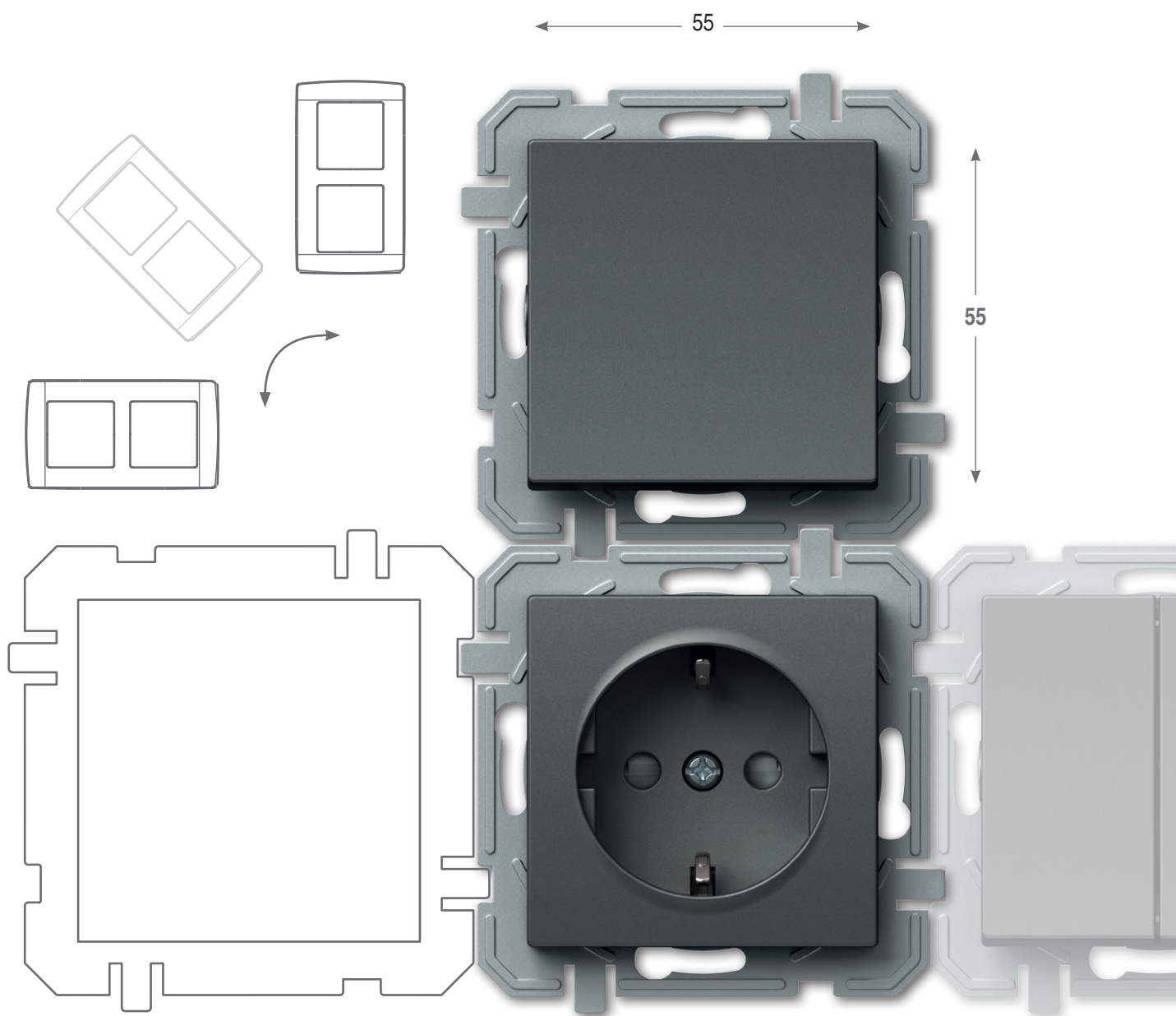

JEDNOSTAVNO RJEŠENJE ZA NAJZAHTJEVNIJE KLIJENTE

LOGIQ obitelj nudi sklopke, regulatore, senzore i utičnice za svaku svrhu na jednome mjestu. Možete upotrebljavati ove proizvode individualno ili u sekvenci. Kao svaka obitelj koja raste i razvija se, LOGIQ obitelj nastavit će razvijati naše proizvode u skladu s Vašim potrebama i željama. Rado ćemo Vas poslušati i ponuditi Vam rješenje koje će na jednostavan i logičan način nastaviti priču LOGIQ obitelji.

SIMPLE FOR THE MOST DEMANDING

The LOGIQ family offers switches, regulators, sensors, and sockets for every purpose in one place. You can use these products individually or in a sequence. Just like every family that grows and develops, the LOGIQ family will continue to develop our range of products in accordance with your needs and wishes. We are happy to listen to you and offer a solution which will simply and logically continue the story of the LOGIQ family.

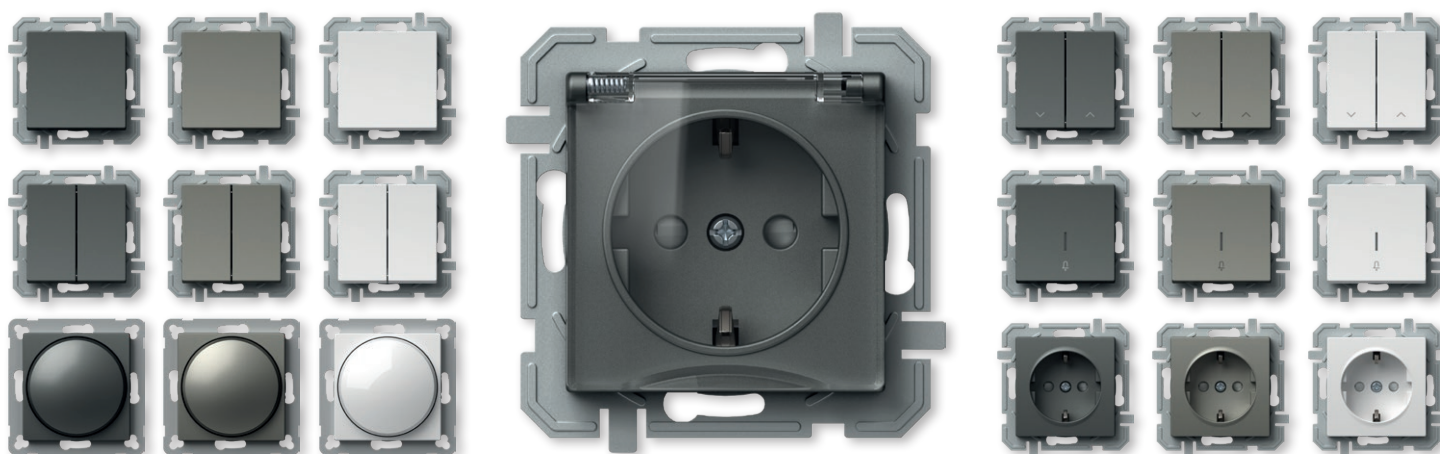

SVE NA JEDNOME MJESTU I MNOGO VIŠE

ALL IN ONE PLACE AND MORE

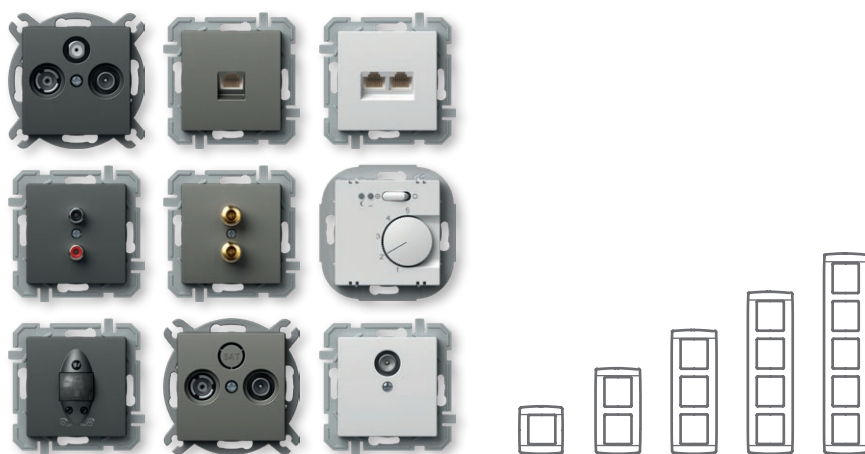

LOGIČNA INSTALACIJA

LOGIQ je rješenje za sustav standardnih okruglih kutija. S pomoću njega možemo planirati jednostavne instalacije, novogradnje i adaptacije, ali i one zahtjevnije. Sustav karakterizira spajanje bez upotrebe vijaka, što će vam uštedjeti vrijeme pri ugradnji elemenata.

LOGICAL INSTALLATION

LOGIQ is a solution for the system of standardized round installations boxes. It can be used for simple as well as more demanding installations, new buildings and adaptations. The system is characterised by plug-in contacts which save time during installation of elements.

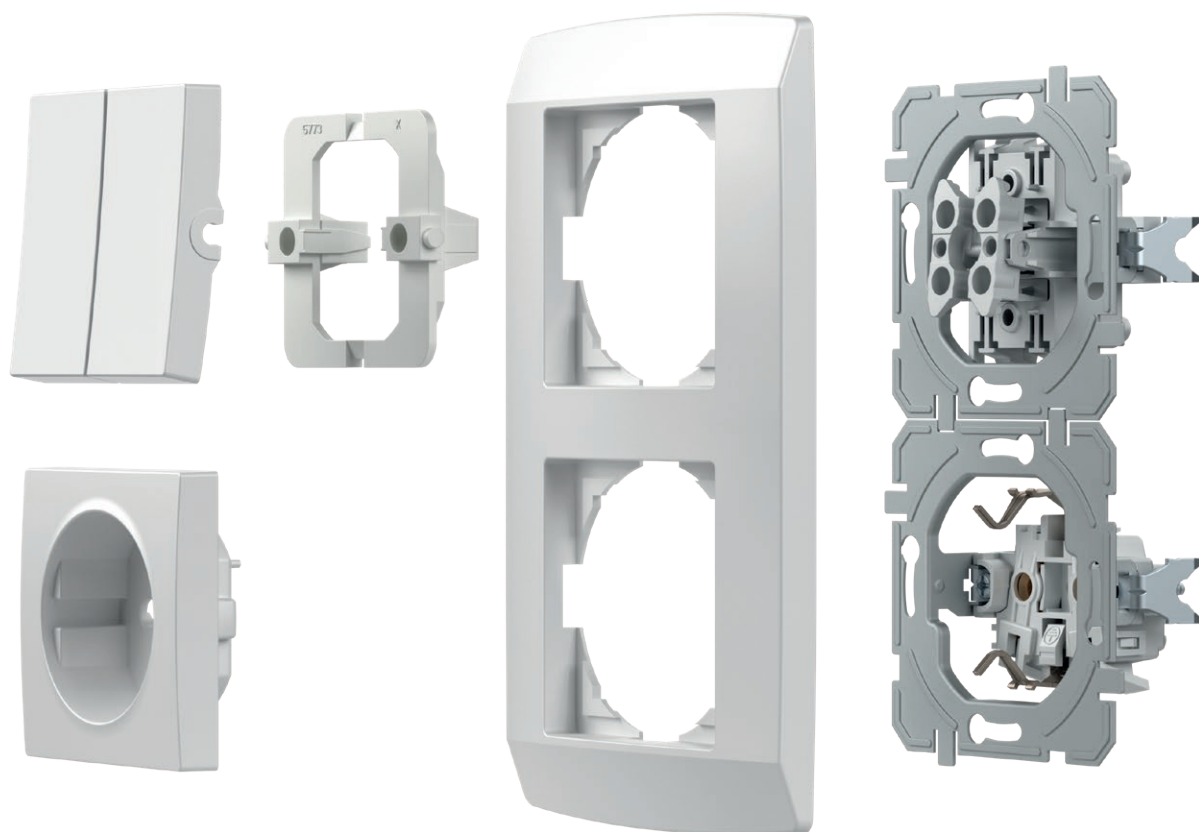

DOBRO JE ZNATI

GOOD TO KNOW



Sve su utičnice opremljene sigurnosnim sklopovima koji osiguravaju zaštitu od kontakta s naponom.

All the sockets are equipped with a safety shutters assuring the protection to live contacts.



Dobro smišljena konstrukcija sklopki omogućuje i jednostavno dodatno osvjetljenje.

A well-planned switch construction makes easy illumination possible also subsequently.



Pouzdanost preklopa osiguravaju kontakti izrađeni od srebrne legure.

Contacts made of silver alloy guarantee safe switching.



Spajanje bez vijaka omogućuje brzo i pouzdano priključenje vodiča. Na isti se kontakt mogu pričvrstiti dva vodiča različitih presjeka.

Plug-in contacts enable quick and reliable attachment of wires. Two wires of different diameters can be attached to the same contact.



Nožice omogućavaju dublje pričvršćivanje (i preko keramičkih pločica i sl.)

Fixing claws enable deeper fixing (also through ceramic tiles, etc.)







Montažne kutije olakšat će Vam posao ugradnje. Zajamčene su odgovarajuće duljine.

Easy-fitting installation boxes will make your work easier. Proper lengths are guaranteed.



SQ11 PW IN 01 XO

tip type	naziv description	tehnički opis technical data	boja colour	opcijski opis 1 optional data 1	opcijski opis 2 optional data 2	opcijski opis 3 optional data 3
SQ10	SKLOPKA JEDNOPOLNA SWITCH 1WAY	10AX 250V~	<input type="checkbox"/> PW bijela – sjaj polar white	 NT neutralna neutral	 01	XO bez okvira without cover plate
SQ11	TIPKALO JEDNOPOLNO PUSH BUTTON 1WAY	10A 250V~	<input type="checkbox"/> TI titan titanium	 IN indikator indicator	 02	
SQ22	SKLOPKA DVOPOLNA SWITCH 2POLE	16AX 250V~	<input type="checkbox"/> AT antracit anthracite		 03	
...

SKLOPKA JEDNOPOLNA 10AX 250V~



- SQ10PWXO
- SQ10TIXO
- SQ10ATXO



- 10AX 250V~, tip SQ10
- usklađeno s normom EN 60669-1
- bezvijačano pričvršćivanje vodiča 1.5-2.5mm²

SWITCH 1WAY 10AX 250V~

- 10AX 250V~, type SQ10
- in accordance with EN 60669-1
- plug-in contacts 1.5-2.5mm²



SKLOPKA JEDNOPOLNA 10AX 250V~ __ IN

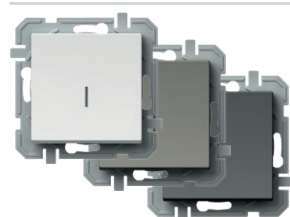

- SQ10PWINXO
- SQ10TIINXO
- SQ10ATINXO

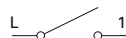

- IN indikator, bez neonske tinjalice
- 10AX 250V~, tip SQ10
- usklađeno s normom EN 60669-1
- bezvijačano pričvršćivanje vodiča 1.5-2.5mm²

SWITCH 1WAY 10AX 250V~ __ IN

- IN indikator, without neon lamp
- 10AX 250V~, type SQ10
- in accordance with EN 60669-1
- plug-in contacts 1.5-2.5mm²



TIPKALO JEDNOPOLNO 10A 250V~



- SQ11PWXO
- SQ11TIXO
- SQ11ATXO

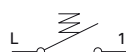

- 10A 250V~, tip SQ11
- usklađeno s normom EN 60669-1
- bezvijačano pričvršćivanje vodiča 1.5-2.5mm²

PUSH BUTTON 1WAY 10A 250V~

- 10A 250V~, type SQ11
- in accordance with EN 60669-1
- plug-in contacts 1.5-2.5mm²



TIPKALO JEDNOPOLNO 10A 250V~ __ IN 01

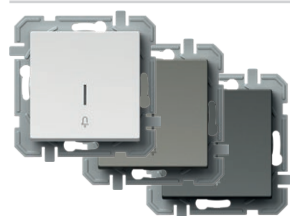

- SQ11PWIN01XO
- SQ11TIIN01XO
- SQ11ATIN01XO

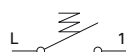

- IN 01 indikator zvona, bez neonske tinjalice
- 10A 250V~, tip SQ11
- usklađeno s normom EN 60669-1
- bezvijačano pričvršćivanje vodiča 1.5-2.5mm²

PUSH BUTTON 1WAY 10A 250V~ __ IN 01

- IN 01 indicator bell, without neon lamp
- 10A 250V~, type SQ11
- in accordance with EN 60669-1
- plug-in contacts 1.5-2.5mm²





- SQ11PWIN02XO
- SQ11TIIN02XO
- SQ11ATIN02XO



TIPKALO JEDNOPOLNO 10A 250V~ __ IN 02

- IN 02 indikator svjetla, bez neonske tinjalice
- 10A 250V~, tip SQ11
- usklađeno s normom EN 60669-1
- bezvijčano pričvršćivanje vodiča 1.5-2.5mm²

PUSH BUTTON 1WAY 10A 250V~ __ IN 02

- IN 02 indicator light, without neon lamp
- 10A 250V~, type SQ11
- in accordance with EN 60669-1
- plug-in contacts 1.5-2.5mm²



- SQ22PWIN03XO
- SQ22TIIN03XO
- SQ22ATIN03XO

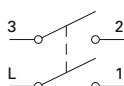

SKLOPKA DVOPOLNA 16AX 250V~ __ IN 03

- IN 03 neutralna 0-1, bez neonske tinjalice
- 16AX 250V~, tip SQ22
- usklađeno s normom EN 60669-1
- vijčano pričvršćivanje vodiča 1.5-2.5mm²

SWITCH 2POLE 16AX 250V~ __ IN 03

- IN 03 neutral 0-1, without neon lamp
- 16AX 250V~, type SQ22
- in accordance with EN 60669-1
- screw contacts 1.5-2.5mm²



- SQ50PWXO
- SQ50TIXO
- SQ50ATXO

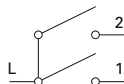

SKLOPKA SERIJSKA 10AX 250V~

- 10AX 250V~, tip SQ50
- usklađeno s normom EN 60669-1
- bezvijčano pričvršćivanje vodiča 1.5-2.5mm²

SWITCH 2GANG-1WAY 10AX 250V~

- 10AX 250V~, type SQ50
- in accordance with EN 60669-1
- plug-in contacts 1.5-2.5mm²

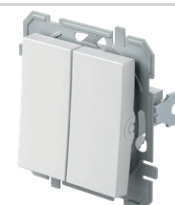

- SQ51PWXO
- SQ51TIXO
- SQ51ATXO

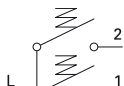

TIPKALO SERIJSKO 10A 250V~

- 10A 250V~, tip SQ51
- usklađeno s normom EN 60669-1
- bezvijčano pričvršćivanje vodiča 1.5-2.5mm²

PUSH BUTTON 2GANG-1WAY 10A 250V~

- 10A 250V~, type SQ51
- in accordance with EN 60669-1
- plug-in contacts 1.5-2.5mm²

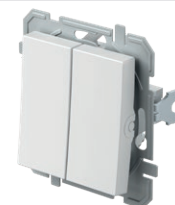

- SQ52PWNT09XO
- SQ52TINT09XO
- SQ52ATNT09XO

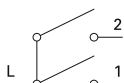

SKLOPKA ŽALUZIJSKA 10AX 250V~ __ NT 09

- NT 09 neutralna gore-dolje
- 10AX 250V~, tip SQ52
- usklađeno s normom EN 60669-1
- bezvijčano pričvršćivanje vodiča 1.5-2.5mm²
- s mehaničkim blokiranjem istodobnog uključivanja

SWITCH SHUTTERS 10AX 250V~ __ NT 09

- NT 09 neutral up-down
- 10AX 250V~, type SQ52
- in accordance with EN 60669-1
- plug-in contacts 1.5-2.5mm²
- with mechanical interblock



- SQ53PWNT09XO
- SQ53TINT09XO
- SQ53ATNT09XO

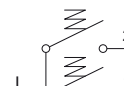

TIPKALO ŽALUZIJSKO 10A 250V~ __ NT 09

- NT 09 neutralna gore-dolje
- 10A 250V~, tip SQ53
- usklađeno s normom EN 60669-1
- bezvijčano pričvršćivanje vodiča 1.5-2.5mm²
- s mehaničkim blokiranjem istodobnog uključivanja

PUSH BUTTON SHUTTERS 10A 250V~ __ NT 09

- NT 09 neutral up-down
- 10A 250V~, type SQ53
- in accordance with EN 60669-1
- plug-in contacts 1.5-2.5mm²
- with mechanical interblock

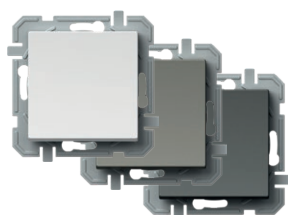

- SQ60PWXO
- SQ60TIXO
- SQ60ATXO

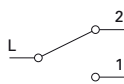

SKLOPKA IZMJENIČNA 10AX 250V~

- 10AX 250V~, tip SQ60
- usklađeno s normom EN 60669-1
- bezvijčano pričvršćivanje vodiča 1.5-2.5mm²

SWITCH 2WAY 10AX 250V~

- 10AX 250V~, type SQ60
- in accordance with EN 60669-1
- plug-in contacts 1.5-2.5mm²



SKLOPKA IZMJENIČNA DVOSTRUKA 10AX 250V~



- SQ63PWXO
- SQ63TIXO
- SQ63ATXO



- 10AX 250V~, tip SQ63
- usklađeno s normom EN 60669-1
- bezvijčano pričvršćivanje vodiča 1.5-2.5mm²

SWITCH DOUBLE 2WAY 10AX 250V~

- 10AX 250V~, type SQ63
- in accordance with EN 60669-1
- plug-in contacts 1.5-2.5mm²



SKLOPKA KRIŽNA 10AX 250V~



- SQ70PWXO
- SQ70TIXO
- SQ70ATXO



- 10AX 250V~, tip SQ70
- usklađeno s normom EN 60669-1
- bezvijčano pričvršćivanje vodiča 1.5-2.5mm²

SWITCH INTERMEDIATE 10AX 250V~

- 10AX 250V~, type SQ70
- in accordance with EN 60669-1
- plug-in contacts 1.5-2.5mm²



SQ10
SQ11

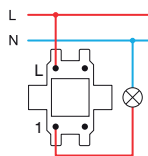

SQ22

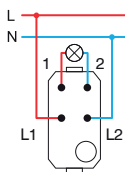

SQ50
SQ51

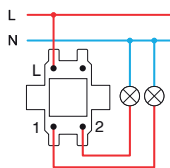

SQ52
SQ53

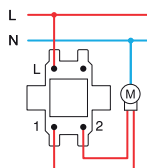

SQ60+SQ60

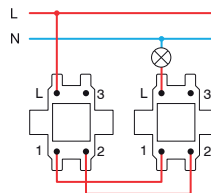

SQ63+SQ63

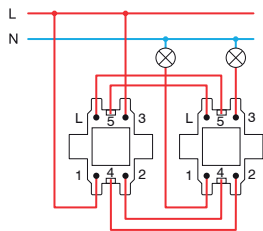

SQ60+SQ70+SQ60

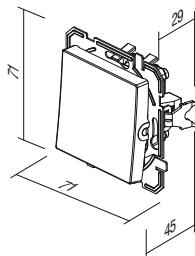
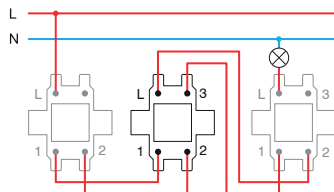

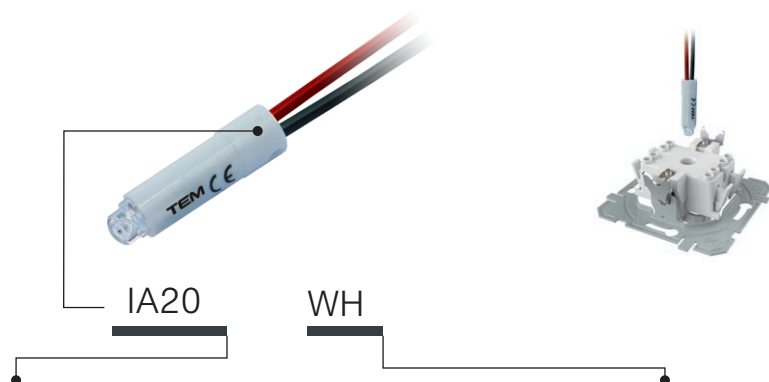

tip type	naziv description	tehnički opis technical data	boja colour
IA10	NEONSKA TINJALICA NEON LAMP	230V~ 0,34W	<input type="checkbox"/> WH bijela white
IA20	LED TINJALICA LED LAMP	230V~ 0,40W	<input checked="" type="checkbox"/> BL plava blue
IA21	LED TINJALICA LED LAMP	24V AC/DC 0,20W	<input checked="" type="checkbox"/> RD crvena red
.	.	.	<input checked="" type="checkbox"/> GR zelena green
.	.	.	<input checked="" type="checkbox"/> OR narančasta orange

NEONSKA TINJALICA 230V~ 0,34W



 IA10OR

- za indicaciju, osvjetljenje ili stalno osvjetljenje sklopke
- u kombinaciji s tipkom s indikatorom

NEON LAMP 230V~ 0,34W

- for indication, illumination or constant illumination of switch
- in combination with button with indicator

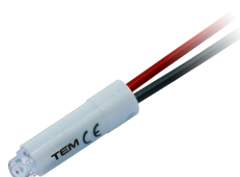
LED TINJALICA 230V AC/DC 0,40W

 IA20WH
 IA20GR
 IA20RD
 IA20BL

- za indicaciju, osvjetljenje ili stalno osvjetljenje sklopke
- u kombinaciji s tipkom s indikatorom

LED LAMP 230V AC/DC 0,40W

- for indication, illumination or constant illumination of switch
- in combination with button with indicator

LED TINJALICA 24V AC/DC 0,20W



 IA21WH
 IA21RD

- za indicaciju, osvjetljenje ili stalno osvjetljenje sklopke
- u kombinaciji s tipkom s indikatorom

LED LAMP 24V AC/DC 0,20W

- for indication, illumination or constant illumination of switch
- in combination with button with indicator

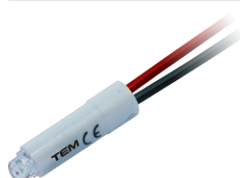
LED TINJALICA 12V AC/DC 0,10W

 IA22WH
 IA22RD

- za indicaciju, osvjetljenje ili stalno osvjetljenje sklopke
- u kombinaciji s tipkom s indikatorom

LED LAMP 12V AC/DC 0,10W

- for indication, illumination or constant illumination of switch
- in combination with button with indicator

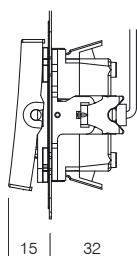

Indikacija /
Indication

*Osvjetljenje /
Illumination

Stalno osvjetljenje
Illumination always on

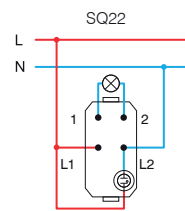
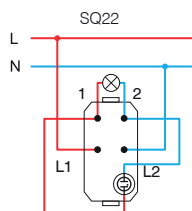
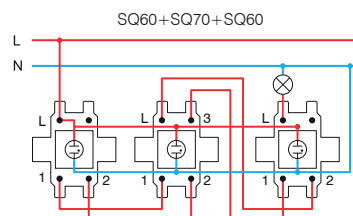
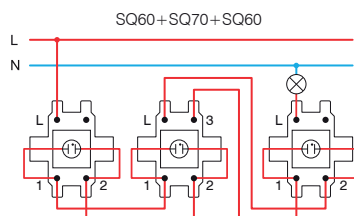
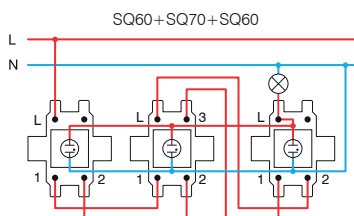
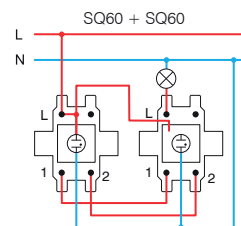
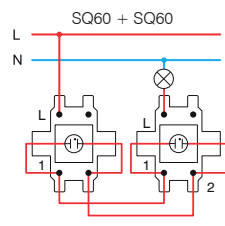
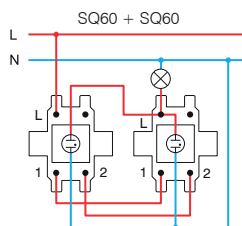
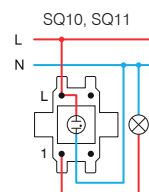
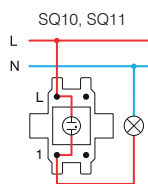
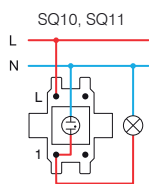

* spajanje nije prikladno za štedljive (CFL, LED) tinjalice /
the connections are not suitable for energy-saving bulbs (CFL, LED)

S O C K E T S V Q

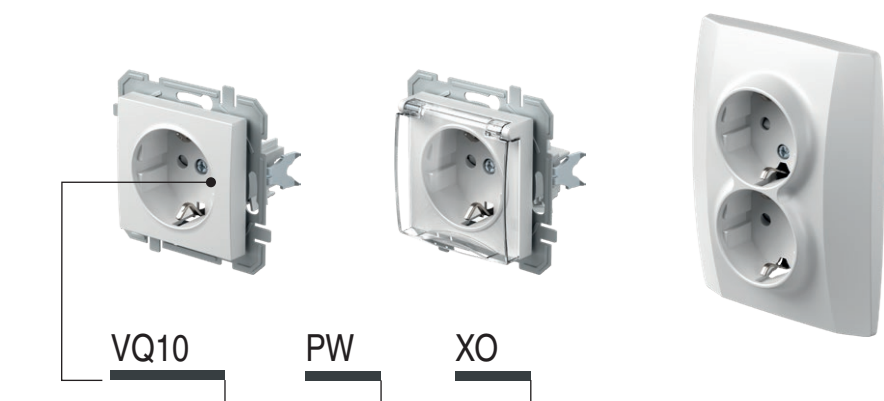

tip type	naziv description	tehnički opis technical data	opcijski podatci 1 optional data 1
VQ10	UTIČNICA ŠUKO SOCKET SCHUKO	2P+E 16A 250V~	XO bez okvira without cover plate
VQ11	UTIČNICA ŠUKO+POKLOPAC SOCKET SCHUKO+COVER	2P+E 16A 250V~	
VQ12	UTIČNICA ŠUKO SOCKET SCHUKO	2P+E 16A 250V~ BV	
:	:	:	
:	:	:	

boja
colour

<input type="checkbox"/> PW	bijela – sjaj polar white	<input type="checkbox"/> PT	bijela+prozirna white+transparent	<input type="checkbox"/> PP	bijela+bijela white+white
<input type="checkbox"/> TI	titan titanium	<input type="checkbox"/> TT	titan+prozirna titanium+transparent	<input type="checkbox"/> TI	titan+titan titanium+titanium
<input type="checkbox"/> AT	antracit anthracite	<input type="checkbox"/> AT	antracit+prozirna anthracite+transparent	<input type="checkbox"/> AA	antracit+antracit anthracite+anthracite
<input type="checkbox"/> RD	crvena red	<input type="checkbox"/> RT	crvena+prozirna red+transparent	<input type="checkbox"/> RR	crvena+crvena red+red
<input type="checkbox"/> GR	zelena green	<input type="checkbox"/> GT	zelena+prozirna green+transparent	<input type="checkbox"/> GG	zelena+zelena green+green
<input type="checkbox"/> OR	narančasta orange	<input type="checkbox"/> OT	narančasta+prozirna orange+transparent	<input type="checkbox"/> OO	narančasta+narančasta orange+orange



šuko – usklađen s normom EN 60884-1, CEE7 (lista standarda III)

schuko - in accordance with EN 60884-1, CEE7 (standard sheet III)

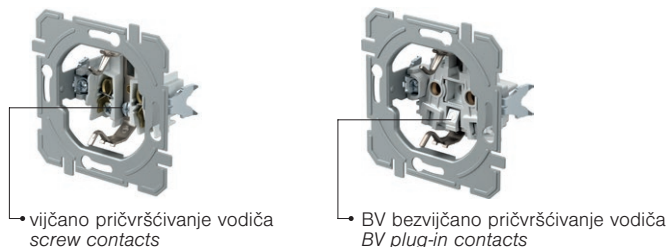

• vijčano pričvršćivanje vodiča
screw contacts

• BV bezvijčano pričvršćivanje vodiča
BV plug-in contacts

UTIČNICA ŠUKO 2P+E 16A 250V~ __ XO

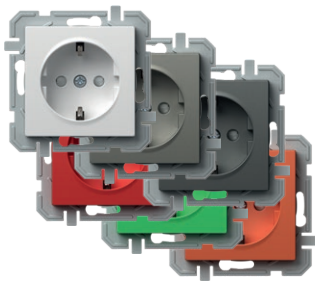

- VQ10PWXO
- VQ10TIXO
- VQ10ATXO
- VQ10RDXO
- VQ10GRXO
- VQ10ORXO

- vijčano pričvršćivanje vodiča 1.5-2.5mm²
- XO bez okvira
- 2P+E šuko
- 16A 250V~, tip VQ10
- KS ugrađena dječja zaštita od dodira kontakta



SOCKET SCHUKO 2P+E 16A 250V~ __ XO

- screw contacts 1.5-2.5mm²
- XO without surround
- 2P+E schuko
- 16A 250V~, type VQ10
- KS build-in child protection – shuttered live contacts

UTIČNICA ŠUKO+POKLOPAC 2P+E 16A 250V~ __ XO

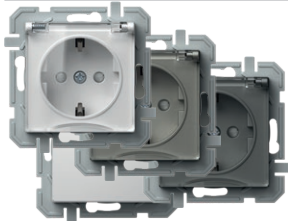

- VQ11PTXO
- VQ11TTXO
- VQ11ATXO
- VQ11PPXO

- vijčano pričvršćivanje vodiča 1.5-2.5mm²
- XO bez okvira
- 2P+E šuko+poklopac
- 16A 250V~, tip VQ11
- KS ugrađena dječja zaštita od dodira kontakta



SOCKET SCHUKO+COVER 2P+E 16A 250V~ __ XO

- screw contacts 1.5-2.5mm²
- XO without surround
- 2P+E schuko+cover
- 16A 250V~, type VQ11
- KS build-in child protection – shuttered live contacts

UTIČNICA ŠUKO 2P+E 16A 250V~ BV __ XO

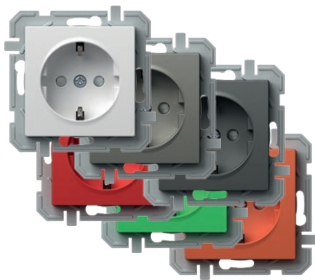

- VQ12PWXO
- VQ12TIXO
- VQ12ATXO
- VQ12RDXO
- VQ12GRXO
- VQ12ORXO

- BV bezvijčano pričvršćivanje vodiča 1.5-2.5mm²
- XO bez okvira
- 2P+E šuko
- 16A 250V~, tip VQ12
- KS ugrađena dječja zaštita od dodira kontakta



SOCKET SCHUKO 2P+E 16A 250V~ BV __ XO

- BV plug-in contacts 1.5-2.5mm²
- XO without surround
- 2P+E schuko
- 16A 250V~, type VQ12
- KS build-in child protection – shuttered live contacts

UTIČNICA ŠUKO+POKLOPAC 2P+E 16A 250V~ BV __ XO



- VQ13PTXO
- VQ13TTXO
- VQ13ATXO
- VQ13PPXO

- BV bezvijčano pričvršćivanje vodiča 1.5-2.5mm²
- XO bez okvira
- 2P+E šuko+poklopac
- 16A 250V~, tip VQ13
- KS ugrađena dječja zaštita od dodira kontakta



SOCKET SCHUKO+COVER 2P+E 16A 250V~ BV __ XO

- BV plug-in contacts 1.5-2.5mm²
- XO without surround
- 2P+E schuko+cover
- 16A 250V~, type VQ13
- KS build-in child protection – shuttered live contacts

UTIČNICA ŠUKO DVOSTRUKA 2P+E 16A 250V~



- VQ16PW
- VQ16TI
- VQ16AT

- 2P+E šuko dvostruka
- 16A 250V~, tip VQ16
- usklađeno s normom IEC 60884-1, CEE7
- vijčano pričvršćivanje vodiča 1.5-2.5mm²
- KS ugrađena dječja zaštita od dodira kontakta



SOCKET SCHUKO DOUBLE 2P+E 16A 250V~

- 2P+E schuko double
- 16A 250V~, type VQ16
- in accordance with IEC 60884-1, CEE7
- screw contacts 1.5-2.5 mm²
- KS build-in child protection – shuttered live contacts

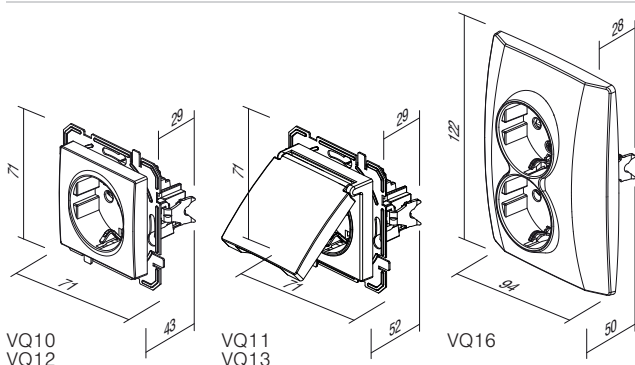



KQ37 **PW** **XO**

tip type	naziv description	tehnički opis technical data	boja colour	opcijski opis 1 optional data 1
KQ11	UTIČNICA TV-R ZAVRŠNA SOCKET TV-R END-LINE	1dB	<input type="checkbox"/> PW bijela – sjaj polar white	XO bez okvira without cover plate
KQ12	UTIČNICA TV-R PROLAZNA SOCKET TV-R THROUGHPASS	10dB	<input type="checkbox"/> TI titan titanium	
KQ16	UTIČNICA SAT-TV-R ZAVRŠNA SOCKET SAT-TV-R END-LINE	3dB	<input type="checkbox"/> AT antracit anthracite	
⋮	⋮	⋮		

UTIČNICA TV OSNOVNA 0dB



- KQ10PWXO
- KQ10TIXO
- KQ10ATXO

- TV osnovna
- prigušenje 0dB
- stražnji konektor – F standard

SOCKET TV BASIC 0dB

- TV basic
- reduction 0dB
- back connector – F standard



UTIČNICA TV-R ZAVRŠNA 1dB



- KQ11PWXO
- KQ11TIXO
- KQ11ATXO

- TV-R završna
- frekvencijski raspon 5÷862 MHz
- prigušenje: R-1.5dB, TV-1dB
- usklađeno s normom EN 50083-1
- vijčano priključenje

SOCKET TV-R END-LINE 1dB

- TV-R end-line
- frequency range 5÷862 MHz
- reduction: R-1.5dB, TV-1dB
- in accordance with EN 50083-1
- screw contact



UTIČNICA TV-R PROLAZNA 10dB



- KQ12PWXO
- KQ12TIXO
- KQ12ATXO

- TV-R prolazna
- frekvencijski raspon 5÷862 MHz
- prigušenje: R-10dB, TV-10dB, prolaznost-2dB
- usklađeno s normom EN 50083-1
- vijčano priključenje

SOCKET TV-R THROUGHPASS 10dB

- TV-R throughpass
- frequency range 5÷862 MHz
- reduction: R-10dB, TV-10dB, trough-2dB
- in accordance with EN 50083-1
- screw contacts



UTIČNICA SAT-TV-R ZAVRŠNA 3dB



- KQ16PWXO
- KQ16TIXO
- KQ16ATXO

- SAT-TV-R završna
- frekvencijski raspon 5÷2400 MHz
- prigušenje: R-1dB, TV-1.5dB, SAT-3dB
- usklađeno s normom EN 50083-1
- vijčano pričvršćivanje

SOCKET SAT-TV-R END-LINE 3dB

- SAT-TV-R end-line
- frequency range 5÷2400 MHz
- reduction: R-1dB, TV-1.5dB, SAT-3dB
- in accordance with EN 50083-1
- screw contacts



UTIČNICA AUDIO 2xRCA



- KQ22PWXO
- KQ22TIXO
- KQ22ATXO

- audio 2xRCA
- pričvrščivanje vodiča lemljenjem

SOCKET AUDIO 2xRCA

- audio 2xRCA
- soldering connection of cable



UTIČNICA AUDIO ZA ZVUČNIKE



- KQ23PWXO
- KQ23TIXO
- KQ23ATXO

- audio 2x Ø4mm
- za pričvrščivanje vodiča za zvučnike, utikača Ø4mm ili vijluškaste kablanske stopice
- pričvrščivanje vodiča lemljenjem sa stražnje strane

SOCKET AUDIO LOUDSPEAKERS

- audio 2x Ø4mm
- to accommodate speaker wire, banana plug Ø4mm or spades
- soldering connection of cable at the back side



UTIČNICA TEL KS RJ11 6/4



- KQ36PWXO
- KQ36TIXO
- KQ36ATXO

- KS keystone standard pričvrščivanja
- RJ11 6/4
- usklađeno s normom IEC 60603-7

SOCKET TEL KS RJ11 6/4

- KS keystone fixing standard
- RJ11 6/4
- in accordance with IEC 60603-7



UTIČNICA CAT5e KS RJ45 8/8

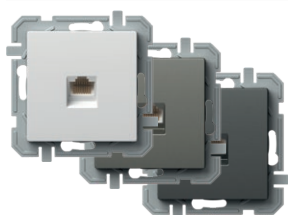

- KQ37PWXO
- KQ37TIXO
- KQ37ATXO

- KS keystone standard pričvrščivanja
- CAT5e, RJ45 8/8
- usklađeno s normom IEC 60603-7

SOCKET CAT5e KS RJ45 8/8

- KS keystone fixing standard
- CAT5e, RJ45 8/8
- in accordance with IEC 60603-7



UTIČNICA TEL KS DVOSTRUKA 2x RJ11 6/4

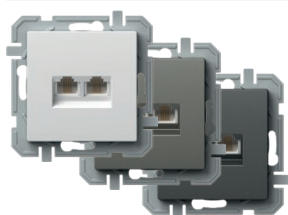

- KQ38PWXO
- KQ38TIXO
- KQ38ATXO

- KS keystone standard pričvrščivanja
- 2x RJ11, 6/4
- usklađeno s normom IEC 60603-7

SOCKET TEL KS DOUBLE 2x RJ11 6/4

- KS keystone fixing standard
- 2x RJ11, 6/4
- in accordance with IEC 60603-7



UTIČNICA CAT5e KS DVOSTRUKA 2x RJ45 8/8

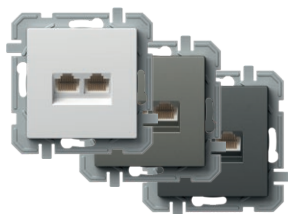

- KQ39PWXO
- KQ39TIXO
- KQ39ATXO

- KS keystone standard pričvrščivanja
- 2x CAT5e, RJ45 8/8
- usklađeno s normom IEC 60603-7

SOCKET CAT5e KS DOUBLE 2x RJ45 8/8

- KS keystone fixing standard
- 2x CAT5e, RJ45 8/8
- in accordance with IEC 60603-7



UTIČNICA TEL LT RJ11 6/4

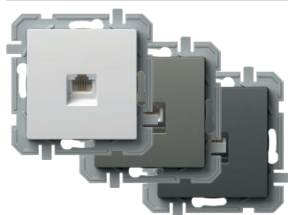

- KQ35PWXO
- KQ35TIXO
- KQ35ATXO

- TEL LT vijak
- vijčano pričvrščivanje vodiča
- RJ11 6/4
- usklađeno s normom IEC 60603-7

SOCKET TEL LT RJ11 6/4

- TEL LT screw
- screw contacts
- RJ11 6/4
- in accordance with IEC 60603-7



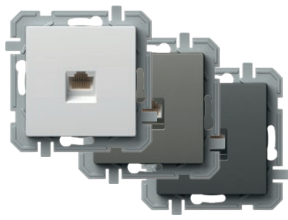

- KQ40PWXO
- KQ40TIXO
- KQ40ATXO

UTIČNICA CAT6s KS RJ45 8/8 SLIM

- KS keystone standard pričvrščivanja
- CAT6s, RJ45 8/8
- uskladen s normom IEC 60603-7

SOCKET CAT6s KS RJ45 8/8 SLIM

- KS keystone fixing standard
- CAT6s, RJ45 8/8
- in accordance with IEC 60603-7

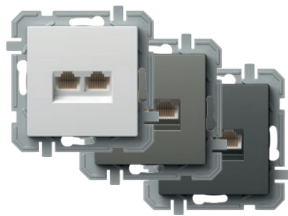

- KQ41PWXO
- KQ41TIXO
- KQ41ATXO

UTIČNICA CAT6s KS DVOSTRUKA 2x RJ45 8/8 SLIM

- KS keystone standard pričvrščivanja
- 2x CAT6s, RJ45 8/8
- uskladen s normom IEC 60603-7

SOCKET CAT6s KS DOUBLE 2x RJ45 8/8 SLIM

- KS keystone fixing standard
- 2x CAT6s, RJ45 8/8
- in accordance with IEC 60603-7

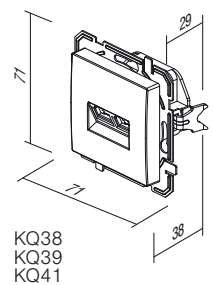
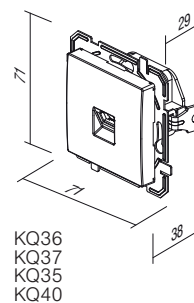
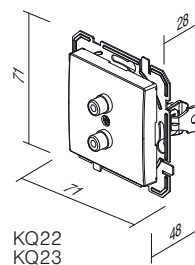
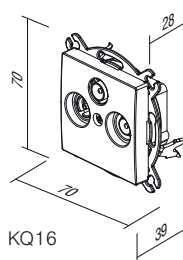
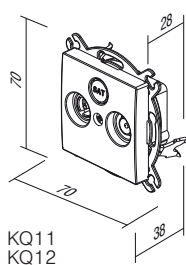
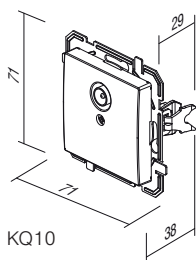



EQ15

PW

XO

tip type	naziv description	tehnički podatci technical data	boja colour	opcijski opis 1 optional data 1
EQ15	ZATAMNJIVAČ ROTACIJSKI IZMJEN DIMMER ROTATIVE 2WAY	RL 400W	<input type="checkbox"/> PW bijela – sjaj polar white	XO bez okvira without cover plate
EQ16	ZATAMNJIVAČ ROTACIJSKI IZMJEN DIMMER ROTATIVE 2WAY	RLC 400W	<input type="checkbox"/> TI titan titanium	
EQ19	ZATAMNJIVAČ ROTACIJSKI IZMJEN DIMMER ROTATIVE 2WAY	LED 100W	<input type="checkbox"/> AT antracit anthracite	
⋮	⋮	⋮		

ZATAMNJIVAČ ROTACIJSKI IZMJEN RL 400W



- EQ15PWXO
- EQ15TIXO
- EQ15ATXO

- rotacijski s izmjeničnom sklopkom
- opterećenje RL, 40W – 400W
- mogućnost povezivanja s izmjeničnom sklopkom
- nije dopušteno povezivanje više zatamnivača
- usklađeno s normama EN 60669-1 i EN 60669-2-1
- bezvijačno pričvršćivanje vodiča 1.5-2.5mm²
- napajanje 230V[~] 50 Hz
- priložen zamjenjivi osigurač



DIMMER ROTATIVE 2WAY RL 400W

- rotation control with 2-way switch
- load RL, 40W - 400W
- 2-way switch combination is possible
- more dimmers combination is not allowed
- in accordance with EN 60669-1 and EN 60669-2-1
- plug-in contacts 1.5mm²
- supply 230V[~] 50Hz
- replaceable fuse included

ZATAMNJIVAČ ROTACIJSKI IZMJEN RLC 400W

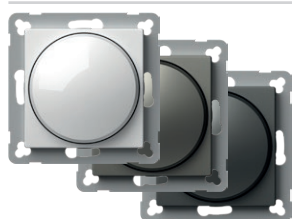

- EQ16PWXO
- EQ16TIXO
- EQ16ATXO

- rotacijski s izmjeničnom sklopkom
- opterećenje RLC, 20W – 400W
- mogućnost povezivanja s izmjeničnom sklopkom
- nije dopušteno povezivanje više zatamnivača
- usklađen s normama EN 60669-1 i EN 60669-2-1
- bezvijačno pričvršćivanje vodiča 1.5mm²
- napajanje 230V[~] 50 Hz
- elektronski osigurač



DIMMER ROTATIVE 2WAY RLC 400W

- rotation control with 2-way switch
- load RLC, 20W - 400W
- 2-way switch combination is possible
- more dimmers combination is not allowed
- in accordance with EN 60669-1 and EN 60669-2-1
- plug-in contacts 1.5mm²
- supply 230V[~] 50Hz
- electronic fuse

ZATAMNJIVAČ ROTACIJSKI IZMJEN LED 100W

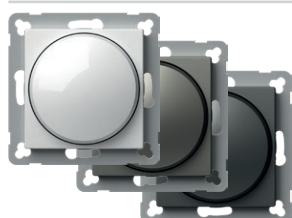

- EQ19PWXO
- EQ19TIXO
- EQ19ATXO

- rotacijski s izmjeničnom sklopkom
- opterećenje: LED, 0-100W (max. 10 LED tinjalica)
GLS, 10-250W
- mogućnost povezivanja s izmjeničnom sklopkom
- nije dopušteno povezivanje više zatamnivača
- usklađeno s normama EN 60669-1 i EN 60669-2-1
- bezvijačno pričvršćivanje vodiča 1.5-2.5mm²
- napajanje 230V[~] 50 Hz
- priložen zamjenjivi osigurač



DIMMER ROTATIVE 2WAY LED 100W

- rotation control with 2-way switch
- load: LED, 0-100W (max. 10 LEDs)
GLS, 10-250W
- 2-way switch combination is possible
- more dimmers combination is not allowed
- in accordance with EN 60669-1 and EN 60669-2-1
- plug-in contacts 1.5mm²
- supply 230V[~] 50Hz
- replaceable fuse included

EQ15, EQ16, EQ19

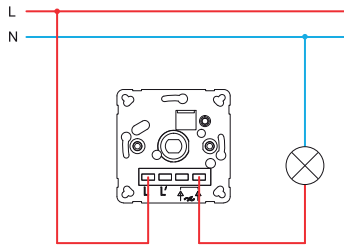

EQ15, EQ16, EQ19

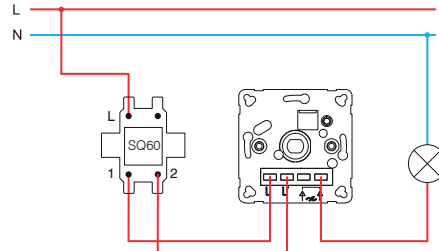

EQ15, EQ16, EQ19

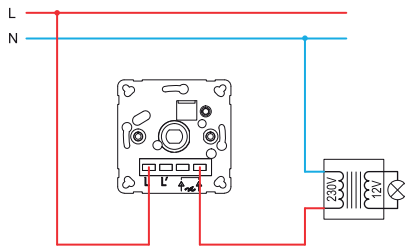

EQ15, EQ16, EQ19

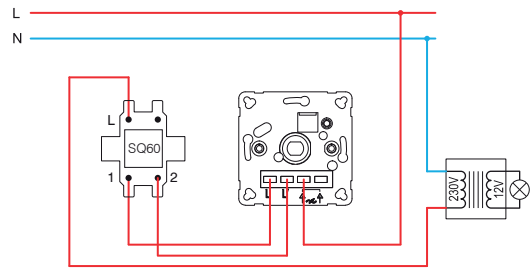

EQ16, EQ19

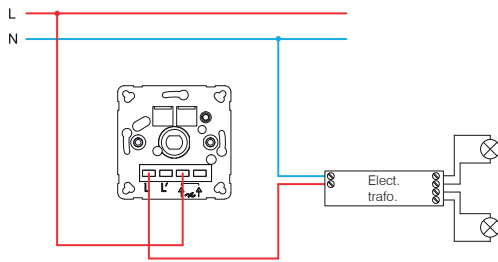

EQ16, EQ19

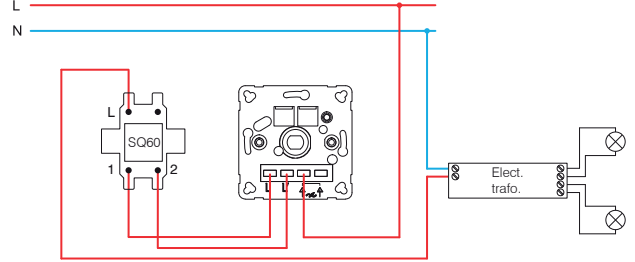

EQ15 (40÷400W)

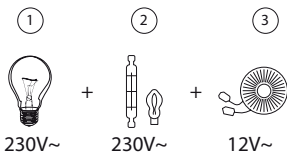

- 1 - žarulja sa žarnom niti / incandescent lamp
- 2 - halogena žarulja / halogen lamp

EQ16 (20÷400W)

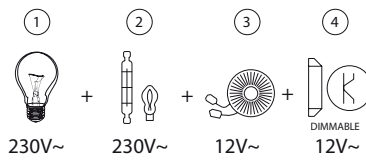

- 3 - klasični transformator / classical transformer
- 4 - elektronički transformator s mogućnošću prigušivanja / dimmable electronic transformer

EQ19 (GLS 10÷250W ; LED 0÷100W)

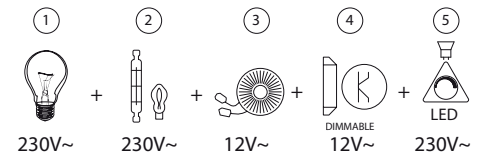

- 5 - LED tinjalica s regulacijom osvijetljenja / dimmable LED lamp

IR SKLOPKA 5A 230V~



- EQ32PWXO
- EQ32TIXO
- EQ32ATXO

- IR infracrvena sklopka
- napajanje: 230V~ ±10 % 50Hz
- relej: 5A / 250V~ izlaz za ograničeni strujni tok s visokim otporom za prolaz kroz ništicu
- razina zaštite: IP40
- presjek žica na kontaktnom terminalu: 0,75 – 2,5 mm²
- kut prepoznavanja: do 110° pri 20°C
- raspon prepoznavanja: približno 8 m pri 20°C
- prilagodljivost vremenskog trajanja: od približno 5 s do 12 min
- prilagodljivost osvjetljenja: od približno 5 do 200 LUX
- radna temperatura: od 0°C do +40°C
- nije prikladan za ugradnju u doze duboke 45 mm
- samo za unutrašnju uporabu

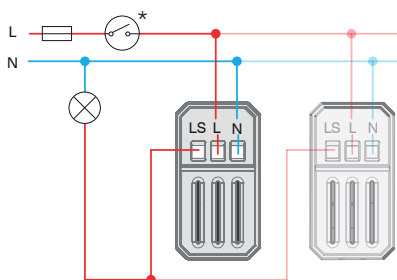

IR SWITCH 5A 230V~

- IR infrared switch
- supply voltage: 230V~ ±10 % 50Hz
- relay: 5A / 250V~ output for limited current with high resistance for zero crossing
- protection rating: IP40
- cross-section of wires at the contact terminal: 0.75 - 2.5 mm²
- detection angle: up to 110° at 20°C
- detection area: approx. 8 m at 20°C
- adjustability of duration: from approx. 5 s to 12 min
- adjustability of brightness: from approx. 5 to 200 LUX
- operating temperature: from 0°C to +40°C
- not suitable for installation in 45 mm deep boxes
- only for indoor usage

TERMOSTAT GRIJANJE 10A 230V~

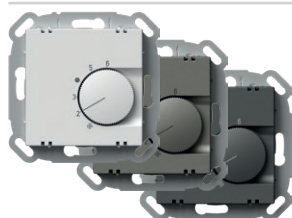

- EQ35PWXO
- EQ35TIXO
- EQ35ATXO

- načina rada: grijanje
- napajanje: 230 V~, 50 Hz
- izlaz: 4 A (max. 10 A), 230 V~, 50 Hz
- izlazni priključak: NC (max. 10 aktuatora)
- raspon regulacije: od +5 °C do +30 °C
- histereza: 0,5 K
- zaštita: IP30
- vrsta senzora: bimetal
- vrsta električnog priključka: opružni kontakti
- vrsta vodiča: 0,75 – 1,5mm² (meka žica) ali 1,0 – 2,5 mm²(tvrda žica)

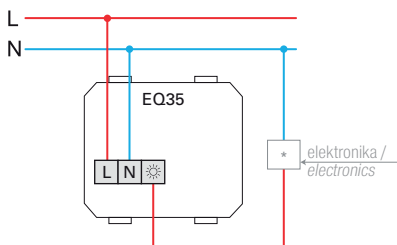

THERMOSTAT HEATING 10A 230V~

- operation mode: heating
- power supply: 230 V~, 50 Hz
- output: 4 A (max. 10 A), 230 V~, 50 Hz
- switching contact: NC (max. 10 actuators)
- regulation range: +5 °C to +30 °C
- hysteresis: 0,5 K
- protection: IP30
- sensor type: bimetal
- type of electrical connection: spring-loaded contacts
- type of conductors: 0,75 – 1,5mm² (flexible-stranded core) or 1,0 – 2,5 mm² (solid core)

TERMOSTAT GRIJANJE / HLAĐENJE 5A 230~

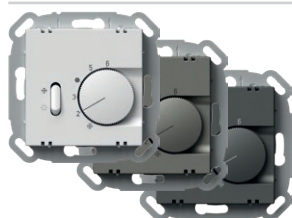

- EQ36PWXO
- EQ36TIXO
- EQ36ATXO

- načina rada: grijanje / hlađenje
- napajanje: 230 V~, 50 Hz
- izlaz: 2 A (max. 5 A), 230 V~, 50 Hz
- izlazni priključak: preklopna sklopka (max. 5 aktuatora)
- raspon regulacije: od +5°C do +30°C
- histereza: 0,5 K
- zaštita: IP30
- vrsta senzora: bimetal
- vrsta električnog priključka: opružni kontakti
- vrsta vodiča: 0,75 – 1,5 mm²(meka žica) ili 1,0 – 2,5 mm²(tvrda žica)

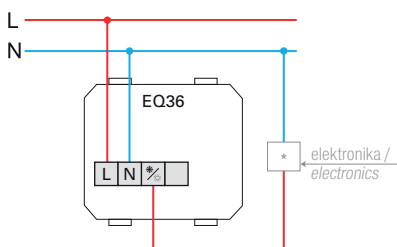

THERMOSTAT HEATING / COOLING 5A 230V~

- operation mode: heating / cooling
- power supply: 230 V~, 50 Hz
- output: 2 A (max. 5 A), 230 V~, 50 Hz
- switching contact: changeover switch (toggler, max. 5 actuators)
- regulation range: +5 °C to +30 °C
- hysteresis: 0,5 K
- protection: IP30
- sensor type: bimetal
- type of electrical connection: spring-loaded contacts
- type of conductors: 0,75 – 1,5mm² (flexible-stranded core) or 1,0 – 2,5 mm² (solid core)

TERMOSTAT PODNO GRIJANJE 16A 230V~



- EQ37PWXO
- EQ37TIXO
- EQ37ATXO

- način rada: podno grijanje
- napajanje: 230 V~, 50 Hz
- izlaz: 2 A (max. 16 A), 230 V~, 50 Hz
- raspon regulacije: od +10 °C do +50 °C
- histereza: 1 K
- zaštita: IP30
- vrsta senzora: NTC u skladu s DIN EN 60730-2-1
- indikatori:
 - crvena LED za grijanje i
 - zelena LED za noćni način sa smanjenom funkcionalnošću
- vrsta električnog priključka: vijčani kontakti
- vrsta vodiča: 0,5 -- 2,5 mm²

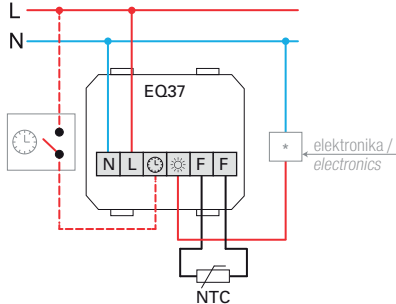

THERMOSTAT FLOOR HEATING 16A 230V~

- operation mode: floor heating
- power supply: 230 V~, 50 Hz
- output: 2 A (max. 16 A), 230 V~, 50 Hz
- regulation range: +10 °C to +50 °C
- hysteresis: 1 K
- protection: IP30
- sensor type: NTC in compliance with DIN EN 60730-2-1
- indicators: Red LED for heating and green LED for night decrease mode
- type of electrical connection: Screw contacts
- type of conductors: 0,5 – 2,5mm²

USB PUNJAČ 5 V 3,0 A



- EQ68PW
- EQ68TI
- EQ68AT

- za punjenje elektroničkih uređaja preko standardnog USB priključka (sukladno i s Apple uređajima)
- napajanje: 100 – 230 V~ 50/60 Hz
- potrošnja energije: 300 mA pri 100V~ / 150 mA pri 230V~
- potrošnja pri mirovanju: 30 mW pri 230 V~
- nazivni izlazni napon: 5 VCD (± 5 %) SELV
- njihanje (ripple) izlaznog napona: 150 mV
- nazivna izlazna snaga: 3,0 A (±10 %)
- vrsta konektora: USB A / USB C
- učinkovitost: maks. 77 %
- radna temperatura: 0 °C / +45 °C (unutrašnja uporaba)
- IP zaštitni razred: IP20, samo za unutrašnju uporabu
- sigurnosni razred uređaja II
- prenaponska kategorija (EN 62109): Klasa III
- vijčano pričvršćivanje vodiča presjeka maks. 2,5 mm²
- uređaj s razmakom kontakta od najmanje 3 mm
- sukladno standardu EN 60950-1 te LVD i EMC direktivama



USB POWER SUPPLY UNIT 5V 3.0A

- for charging electronic devices via a standard USB port (also compatible with Apple devices)
- power supply: 100-230V~ 50/60Hz
- power consumption: 300mA at 100V~/150mA at 230V~
- standby power consumption: 30mW at 230V~
- nominal output voltage: 5 VCD (± 5%) SELV
- output ripple voltage: 150mV
- nominal output current: 3.0 A (±10%)
- connector type: USB A / USB C
- efficiency: maximum of 77%
- operating temperature: 0°C/+45°C (indoor use)
- IP protection class: IP20, indoor use only
- class device II
- overvoltage category (EN 62109): Class III
- screw contacts: max. 2.5 mm²
- device with a contact gap of at least 3mm
- in accordance with the EN 60950-1 and LVD & EMC directives

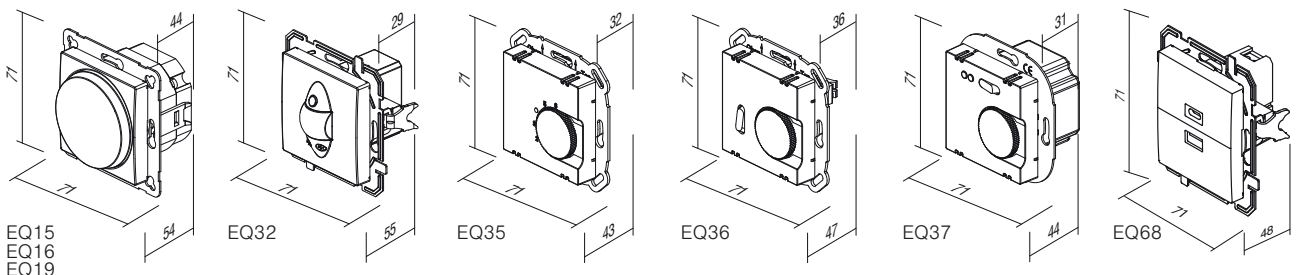

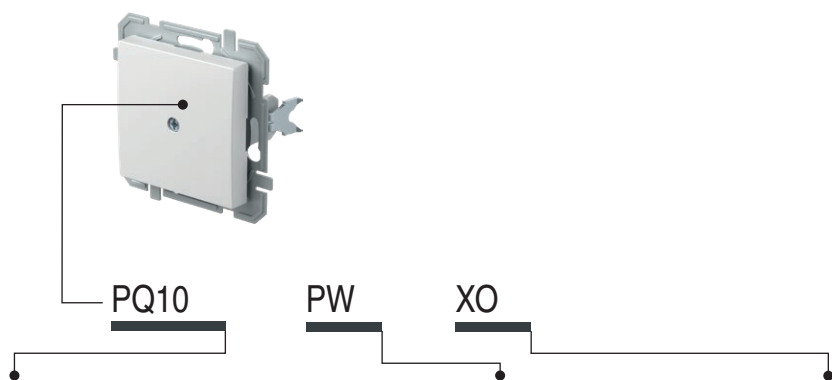

tip type	naziv description	boja colour	opcijski opis 1 optional data 1
PQ10	PUNILO BLANK	<input type="checkbox"/> PW bijela – sjaj polar white	XO bez okvira without cover plate
PQ30	POKLOPAC TAE/TDO COVER TAE/TDO	<input type="checkbox"/> TI titan titanium <input type="checkbox"/> AT antracit anthracite	

PUNILO



- PQ10PWXO
- PQ10TIXO
- PQ10ATXO

- za pokrivanje praznih otvora
BLANK
- for filling up empty spaces



POKLOPAC TAE/TDO

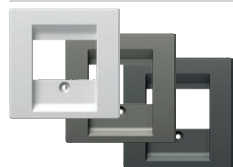

- PQ30PW
- PQ30TI
- PQ30AT

- TAE ili TDO poklopac s vijkom
COVER TAE/TDO
- TAE or TDO cover with screw

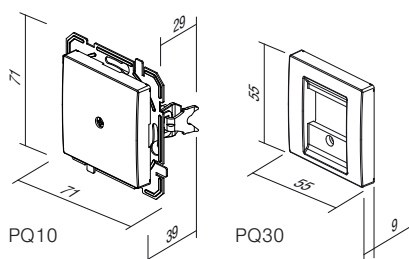

COVER PLATES OQ

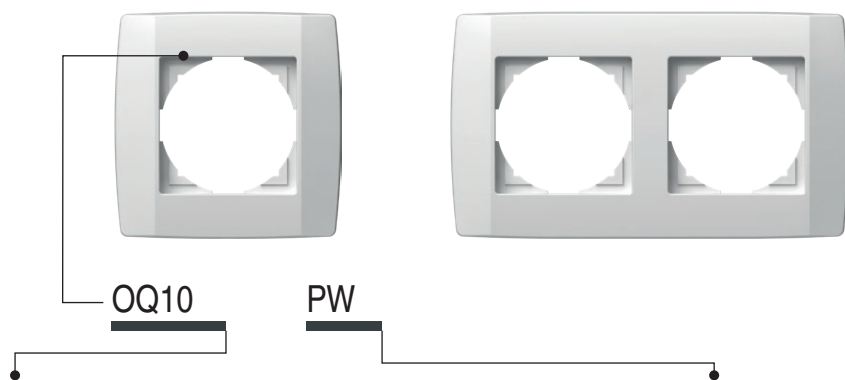

tip type	naziv description	boja colour
OQ10	OKVIR LOGIQ 1 COVER PLATE LOGIQ 1	PW bijela – sjaj polar white
OQ20	OKVIR LOGIQ 2 COVER PLATE LOGIQ 2	TI titan titanium
OQ30	OKVIR LOGIQ 3 COVER PLATE LOGIQ 3	AT antracit anthracite
:	:	
:	:	



OQ10PW
 OQ10TI
 OQ10AT

OKVIR LOGIQ 1

- dekorativni pojedinačni okvir
- usklađeno s normom EN 60669-1

COVER PLATE LOGIQ 1
- decorative cover plate 1-gang
- in accordance with EN 60669-1

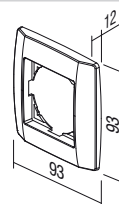

OQ20PW
 OQ20TI
 OQ20AT

OKVIR LOGIQ 2

- dekorativni dvostruki okvir
- u skladu s EN 60669-1

COVER PLATE LOGIQ 2
- decorative cover plate 2-gang
- in accordance with EN 60669-1

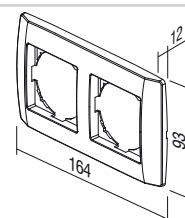

OKVIR LOGIQ 3



- OQ30PW
- OQ30TI
- OQ30AT

- dekorativni trostruki okvir
- u skladu s EN 60669-1

COVER PLATE LOGIQ 3
- decorative cover plate 3-gang
- in accordance with EN 60669-1

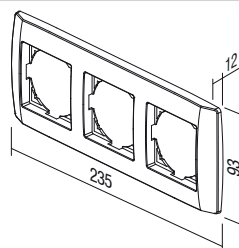

OKVIR LOGIQ 4



- OQ40PW
- OQ40TI
- OQ40AT

- dekorativni četverostruki okvir
- u skladu s EN 60669-1

COVER PLATE LOGIQ 4
- decorative cover plate 4-gang
- in accordance with EN 60669-1

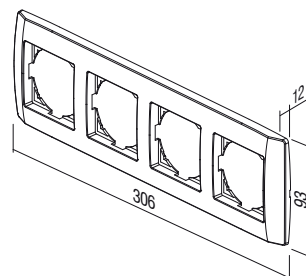

OKVIR LOGIQ 5



- OQ50PW
- OQ50TI
- OQ50AT

- dekorativni peterostruki okvir
- u skladu s EN 60669-1

COVER PLATE LOGIQ 5
- decorative cover plate 5-gang
- in accordance with EN 60669-1

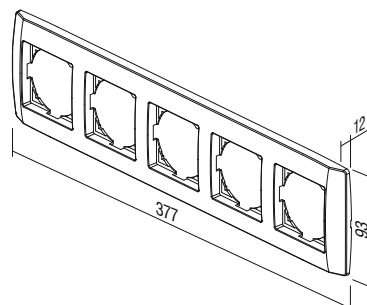

TEM

ekonomik





ekonomik

PLANIRANO ZA SAVRŠENSTVO **Stil je bitan**

Neutralan, kompaktan, elegantan dizajn može se prilagoditi svakom okruženju u kojem boravite ili radite. Ne odstupa od interijera, nego se u nj harmonično uklapa.

PLANNED FOR EXCELLENCE **Style is essential**

A neutral, compact, elegant design is adjustable to every working or living area. It does not stick out from the interior, but rather harmonically fits into it.





ekonomik

HARMONIJA BOJA Odaberite svoju nijansu

Želje mogu biti vrlo različite. Stoga smo za vas pomno odabrali mogućnosti koje vam pružaju pravi odgovor. Neutralna paleta boja dodatno će ispuniti Vaš ambijent – neće vas ograničavati.

HARMONY OF COLOURS Choose your hue

Desires can be very different. Therefore we have carefully selected possibilities for you, which can offer you the right answer. A neutral palette of colours will only complement your ambient - it will not restrict it.

<input type="checkbox"/> PW	bijela sjajna	<i>polar white</i>
<input type="checkbox"/> IW	bež sjajna	<i>ivory white</i>
<input type="checkbox"/> ES	srebrna mat	<i>elox silver</i>
<input type="checkbox"/> CO	bijeli duroplast	<i>white thermoset</i>
<input type="checkbox"/> NB	crna sjajna	<i>night black</i>





JEDNOSTAVNO RJEŠENJE ZA NAJZAHTJEVNIJE KLIJENTE

Pomnim planiranjem osigurali smo kontaktnu zaštitu elemenata pod naponom. Osnovno pričvršćivanje mehanizama s pomoću nožica (1) omogućuje i naknadno učvršćivanje vijcima (2). Takav način pričvršćivanja posebno je primjeren za sigurno i pouzdano pričvršćivanje utičnica.

SIMPLE FOR THE MOST DEMANDING

By careful planning elements under voltage have been protected against touching. Basic fixing of mechanisms with fixing claws (1) allows additional strengthening with screws (2). This manner is especially appropriate for safe and reliable fixing of sockets.



KOMBINIRAJTE PREMA SVOJOJ ŽELJI.
COMBINE AS YOU PLEASE.

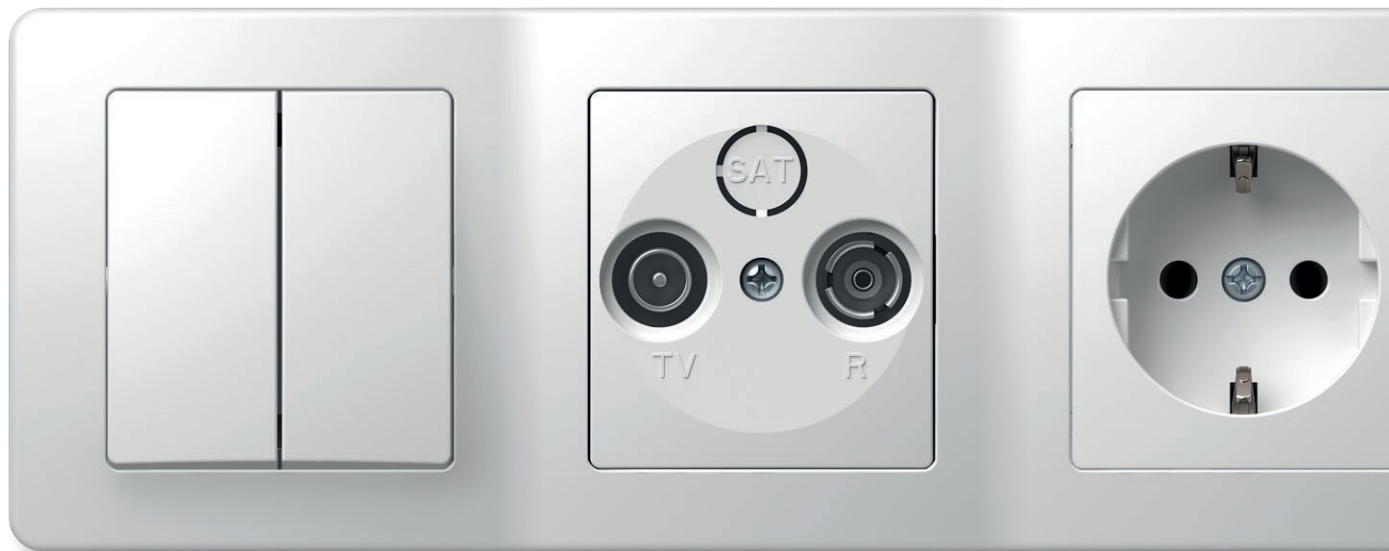

Kombiniranjem štedite prostor na svojem zidu.
Kada imate ograničen prostor, vertikalni raspored ispravno je rješenje.

With combining you save space on the wall.
When faced with a limited space, »vertically« is the right decision.

J E D N O S T A V N A I N S T A L A - C I J A

Ekonomik je rješenje za sustav standardnih okruglih kutija. S pomoću njega možemo planirati jednostavne instalacije, novogradnje i adaptacije, ali i one zahtjevnije. Sustav karakterizira spajanje bez upotrebe vijaka, što će vam uštedjeti vrijeme pri ugradnji elemenata.

EASY INSTALLATION

Ekonomik is a solution for the system of standardized round installations boxes. It can be used for simple as well as more demanding installations, new buildings and adaptations. The system is characterised by plug-in contacts which save time during installation of elements.

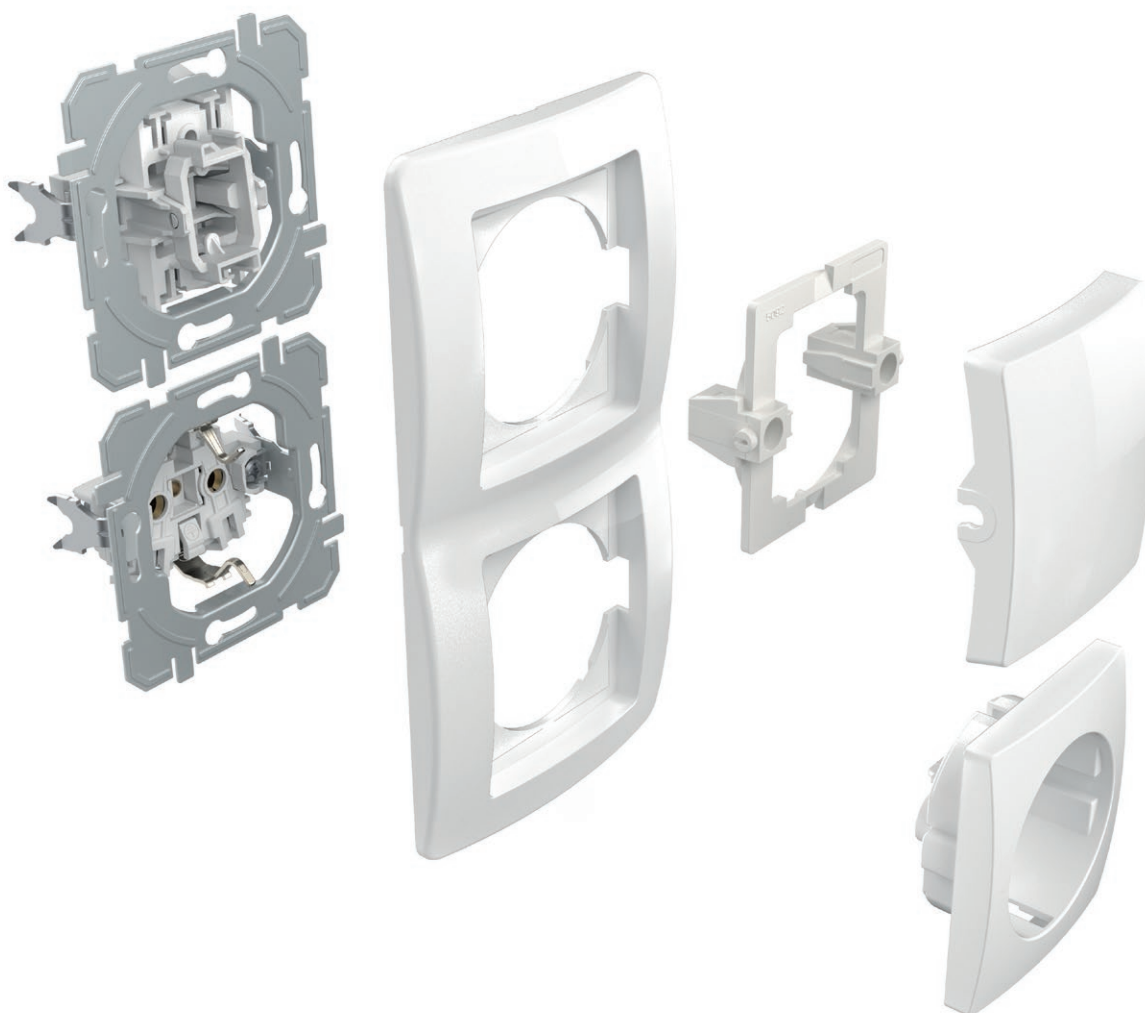

DOBRO JE ZNATI

GOOD TO KNOW



Sve su utičnice opremljene sigurnosnim sklopovima koji osiguravaju zaštitu od kontakta s naponom.

All the sockets are equipped with a safety shutters assuring the protection to live contacts.



Dobro smišljena konstrukcija sklopki omogućuje i jednostavno dodatno osvjetljenje.

A well-planned switch construction makes easy illumination possible also subsequently.



Pouzdanost preklopa osiguravaju kontakti izrađeni od srebrne legure.

Contacts made of silver alloy guarantee safe switching.



Spajanje bez vijaka omogućuje brzo i pouzdano priključenje vodiča. Na isti se kontakt mogu pričvrstiti dva vodiča različitih presjeka.

Plug-in contacts enable quick and reliable attachment of wires. Two wires of different diameters can be attached to the same contact.



Nožice omogućavaju dublje pričvršćivanje (i preko keramičkih pločica i sl.)







Fixing claws enable deeper fixing (also through ceramic tiles, etc.)

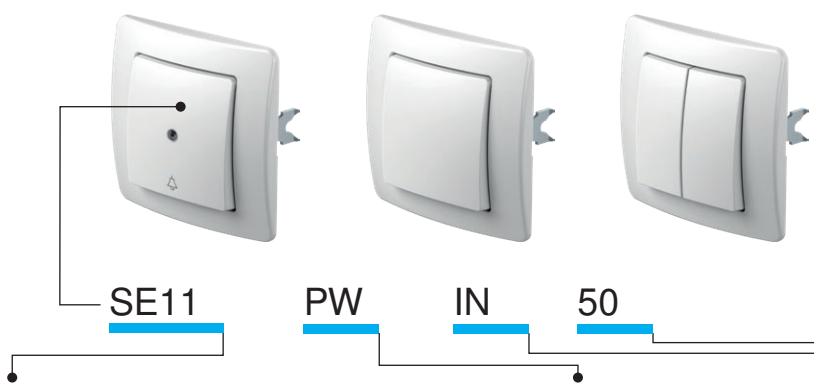

Montažne kutije olakšat će Vam posao ugradnje. Zajamčene su odgovarajuće duljine.

Easy-fitting installation boxes will make your work easier. Proper lengths are guaranteed.



tip type	naziv description	tehnički podaci technical data	boja colour	opcijski podaci 1 optional data 1	opcijski podaci 2 optional data 2
SE10	SKLOPKA JEDNOPOLNA SWITCH 1WAY	10AX 250V~	<input type="checkbox"/> PW bijela sjajna polar white	 NT neutralna neutral	 50
SE11	TIPKALO JEDNOPOLNO PUSH BUTTON 1WAY	10A 250V~	<input type="checkbox"/> IW bež sjajna ivory white	 IN indikator indicator	 51
SE22	SKLOPKA DVOPOLNA SWITCH 2POLE	16AX 250V~	<input type="checkbox"/> ES srebrna mat elox silver		 03
...	<input type="checkbox"/> CO bijeli duroplast white thermoset		 04
...	<input type="checkbox"/> NB crna sjajna night black		...

SKLOPKA JEDNOPOLNA 10AX 250V ~

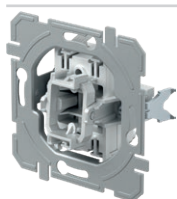

SE10

- 10AX 250V~, tip SE10
- sukladno normi EN 60669-1
- bezvijčani kontakti 1,5-2,5mm²

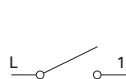

SWITCH 1WAY 10AX 250V~
- 10AX 250V~, type SE10
- in accordance with EN 60669-1
- plug-in contacts 1.5-2.5mm²

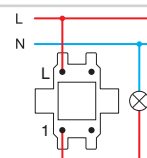

TIPKALO JEDNOPOLNO 10A 250V ~

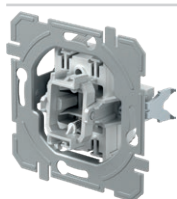

SE11

- 10A 250V~, tip SE11
- sukladno normi EN 60669-1
- bezvijčani kontakti 1,5-2,5mm²

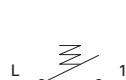

PUSH BUTTON 1WAY 10A 250V~
- 10A 250V~, type SE11
- in accordance with EN 60669-1
- plug-in contacts 1.5-2.5mm²

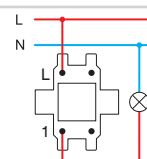

SKLOPKA DVOPOLNA 16AX 250V ~

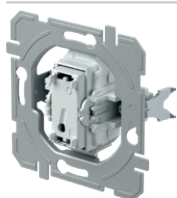

SE22

- 16AX 250V~, tip SE22
- sukladno normi EN 60669-1
- vijčano pričvršćivanje vodiča presjeka 1,5-2,5mm²
- samo u kombinaciji s tipkom TE10__NT03

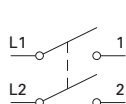

SWITCH 2POLE 16AX 250V~
- 16AX 250V~, type SE22
- in accordance with EN 60669-1
- screw contacts 1.5-2.5mm²
- only in combination with button TE10__NT03

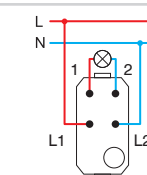

SKLOPKA SERIJSKA JEDNOPOLNA 10AX 250V ~

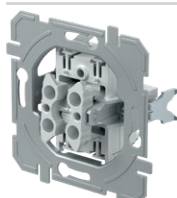

SE50

- 10AX 250V~, tip SE50
- sukladno normi EN 60669-1
- bezvijčani kontakti 1,5-2,5mm²

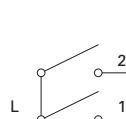

SWITCH 2GANG-1WAY 10AX 250V~
- 10AX 250V~, type SE50
- in accordance with EN 60669-1
- plug-in contacts 1.5-2.5mm²

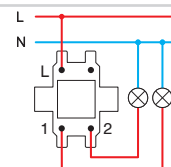

TIPKALO SERIJSKO-JEDNOPOLNO 10A 250V ~

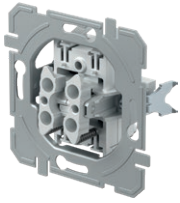

SE51

- 10A 250V~, tip SE51
- sukladno normi EN 60669-1
- bezvijčani kontakti 1,5-2,5mm²

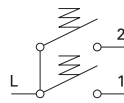

PUSH BUTTON 2GANG-1WAY 10A 250V~

- 10A 250V~, type SE51
- in accordance with EN 60669-1
- plug-in contacts 1.5-2.5mm²

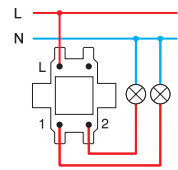

SKLOPKA ŽALUZIJSKA 10AX 250V ~

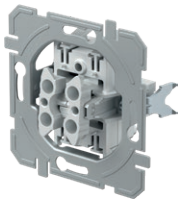

SE52

- 10AX 250V~, tip SE52
- sukladno normi EN 60669-1
- bezvijčani kontakti 1,5-2,5mm²
- s mehaničkom blokadom

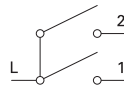

SWITCH SHUTTERS 10AX 250V~

- 10AX 250V~, type SE52
- in accordance with EN 60669-1
- plug-in contacts 1.5-2.5mm²
- with mechanical interblock

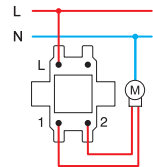

TIPKALO ŽALUZIJSKO 10A 250V ~

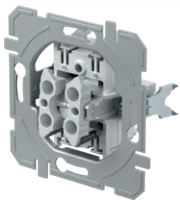

SE53

- 10A 250V~, tip SE53
- sukladno normi EN 60669-1
- bezvijčani kontakti 1,5-2,5mm²
- s mehaničkom blokadom

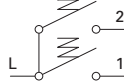

PUSH BUTTON SHUTTERS 10A 250V~

- 10A 250V~, type SE53
- in accordance with EN 60669-1
- plug-in contacts 1.5-2.5mm²
- with mechanical interblock

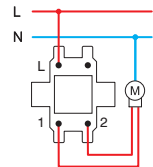

SKLOPKA IZMJENIČNA 10AX 250V ~

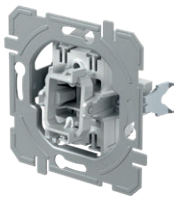

SE60

- 10AX 250V~, tip SE60
- sukladno normi EN 60669-1
- bezvijčani kontakti 1,5-2,5mm²

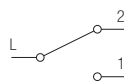

SWITCH 2WAY 10AX 250V~

- 10AX 250V~, type SE60
- in accordance with EN 60669-1
- plug-in contacts 1.5-2.5mm²

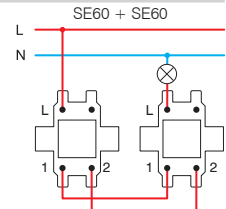

SKLOPKA IZMJENIČNA DVOSTRUKA 10AX 250V ~

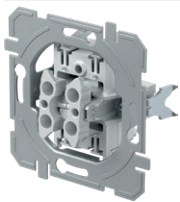

SE63

- 10AX 250V~, tip SE63
- sukladno normi EN 60669-1
- bezvijčani kontakti 1,5-2,5mm²



SWITCH DOUBLE 2WAY 10AX 250V~

- 10AX 250V~, type SE63
- in accordance with EN 60669-1
- plug-in contacts 1.5-2.5mm²

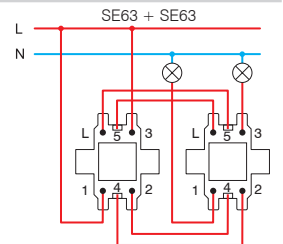

SKLOPKA KRIŽNA 10AX 250V ~

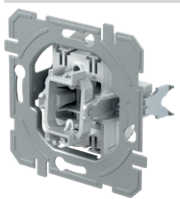

SE70

- 10AX 250V~, tip SE70
- sukladno normi EN 60669-1
- bezvijčani kontakti 1,5-2,5mm²



SWITCH INTERMEDIATE 10AX 250V~

- 10AX 250V~, type SE70
- in accordance with EN 60669-1
- plug-in contacts 1.5-2.5mm²

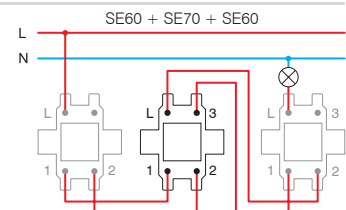

SKLOPKA JEDNOPOLNA 10AX 250V ~



- SE10PW
- SE10IW
- SE10ES
- SE10CO
- SE10NB

- 10AX 250V~, tip SE10
- sukladno normi EN 60669-1
- bezvižčani kontakti 1,5-2,5mm²

SWITCH 1WAY 10AX 250V~
- 10AX 250V~, type SE10
- in accordance with EN 60669-1
- plug-in contacts 1.5-2.5mm²



SKLOPKA JEDNOPOLNA 10AX 250V~ __ IN



- SE10PWIN
- SE10IWIN
- SE10ESIN
- SE10COIN
- SE10NBIN

- IN indikator
- 10AX 250V~, tip SE10
- sukladno normi EN 60669-1
- bezvižčani kontakti 1,5-2,5mm²

SWITCH 1WAY 10AX 250V~ __ IN
- IN indicator
- 10AX 250V~, type SE10
- in accordance with EN 60669-1
- plug-in contacts 1.5-2.5mm²



TIPKALO JEDNOPOLNO 10A 250V ~



- SE11PW
- SE11IW
- SE11ES
- SE11CO
- SE11NB

- 10A 250V~, tip SE11
- sukladno normi EN 60669-1
- bezvižčani kontakti 1,5-2,5mm²

PUSH BUTTON 1WAY 10A 250V~
- 10A 250V~, type SE11
- in accordance with EN 60669-1
- plug-in contacts 1.5-2.5mm²



TIPKALO JEDNOPOLNO 10A 250V ~ __ TI 50



- SE11PWTI50
- SE11IWTI50
- SE11ESTI50
- SE11COTI50
- SE11NBTI50

- TI 50 indikator zvono + neonska tinjalica
- 10A 250V~, tip SE11
- sukladno normi EN 60669-1
- bezvižčani kontakti 1,5-2,5mm²

PUSH BUTTON 1WAY 10A 250V~ __ TI 50
- TI 50 indicator bell+neon lamp
- 10A 250V~, type SE11
- in accordance with EN 60669-1
- plug-in contacts 1.5-2.5mm²



TIPKALO JEDNOPOLNO 10A 250V ~ __ TI 51



- SE11PWTI51
- SE11IWTI51
- SE11ESTI51
- SE11COTI51
- SE11NBTI51

- TI 51 indikator svjetlo + neonska tinjalica
- 10A 250V~, tip SE11
- sukladno normi EN 60669-1
- bezvižčani kontakti 1,5-2,5mm²

PUSH BUTTON 1WAY 10A 250V~ __ TI 51
- TI 51 indicator light+neon lamp
- 10A 250V~, type SE11
- in accordance with EN 60669-1
- plug-in contacts 1.5-2.5mm²



TIPKALO JEDNOPOLNO 10A 250V ~ __ IL



- SE11PWIL
- SE11IWIL
- SE11ESIL
- SE11COIL
- SE11NBIL

- IL natpisna pločica
- 10A 250V~, tip SE11
- sukladno normi EN 60669-1
- bezvižčani kontakti 1,5-2,5mm²

PUSH BUTTON 1WAY 10A 250V~ __ IL
- IL inscription plate
- 10A 250V~, type SE11
- in accordance with EN 60669-1
- plug-in contacts 1.5-2.5mm²



SKLOPKA DVOPOLNA 16AX 250V~ __ IN 03



- SE22PWIN03
- SE22IWIN03
- SE22ESIN03
- SE22NBIN03

- IN 03 neutralna 0-1
- 16AX 250V~, tip SE22
- sukladno normi EN 60669-1
- vijčano pričvršćivanje vodiča presjeka 1,5-2,5mm²

SWITCH 2POLE 16AX 250V~ __ IN 03
- IN 03 neutral 0-1
- 16AX 250V~, type SE22
- in accordance with EN 60669-1
- screw contacts 1.5-2.5mm²





- SE50PW
- SE50IW
- SE50ES
- SE50CO
- SE50NB

SKLOPKA SERIJSKA-JEDNOPOLNA 10AX 250V ~

- 10AX 250V~, tip SE50
- sukladno normi EN 60669-1
- bezvijčani kontakti 1,5-2,5mm²

SWITCH 2GANG-1WAY 10AX 250V~

- 10AX 250V~, type SE50
- in accordance with EN 60669-1
- plug-in contacts 1.5-2.5mm²



- SE51PW
- SE51IW
- SE51ES
- SE51CO
- SE51NB

TIPKALO SERIJSKO-JEDNOPOLNO 10A 250V ~

- 10A 250V~, tip SE51
- sukladno normi EN 60669-1
- bezvijčani kontakti 1,5-2,5mm²

PUSH BUTTON 2GANG-1WAY 10A 250V~

- 10A 250V~, type SE51
- in accordance with EN 60669-1
- plug-in contacts 1.5-2.5mm²



- SE52PWNT09
- SE52IWNT09
- SE52ESNT09
- SE52CONT09
- SE52NBNT09

SKLOPKA ŽALUZIJSKA 10AX 250V ~ __ NT 09

- NT 09 neutralno gore-dolje
- 10AX 250V~, tip SE52
- sukladno normi EN 60669-1
- bezvijčano pričvršćivanje vodiča presjeka 1,5-2,5 mm²
- s mehaničkom blokadom

SWITCH SHUTTERS 10AX 250V~ __ NT 09

- NT 09 neutral up-down
- 10AX 250V~, type SE52
- in accordance with EN 60669-1
- plug-in contacts 1.5-2.5mm²
- with mechanical interblock



- SE53PWNT09
- SE53IWNT09
- SE53ESNT09
- SE53CONT09
- SE53NBNT09

TIPKALO ŽALUZIJSKO 10A 250V~ __ NT 09

- NT 09 neutralno gore-dolje
- 10A 250V~, tip SE53
- sukladno normi EN 60669-1
- bezvijčani kontakti 1,5-2,5mm²
- s mehaničkom blokadom

PUSH BUTTON SHUTTERS 10A 250V~ __ NT 09

- NT 09 neutral up-down
- 10A 250V~, type SE53
- in accordance with EN 60669-1
- plug-in contacts 1.5-2.5mm²
- with mechanical interblock



- SE60PW
- SE60IW
- SE60ES
- SE60CO
- SE60NB

SKLOPKA IZMJENIČNA 10AX 250V ~

- 10AX 250V~, tip SE60
- sukladno normi EN 60669-1
- bezvijčani kontakti 1,5-2,5mm²

SWITCH 2WAY 10AX 250V~

- 10AX 250V~, type SE60
- in accordance with EN 60669-1
- plug-in contacts 1.5-2.5mm²



- SE63PW
- SE63IW
- SE63ES
- SE63CO
- SE63NB

SKLOPKA IZMJENIČNA DVOSTRUKA 10AX 250V ~

- 10AX 250V~, tip SE63
- sukladno normi EN 60669-1
- bezvijčani kontakti 1,5-2,5mm²

SWITCH DOUBLE 2WAY 10AX 250V~

- 10AX 250V~, type SE63
- in accordance with EN 60669-1
- plug-in contacts 1.5-2.5mm²



- SE70PW
- SE70IW
- SE70ES
- SE70CO
- SE70NB

SKLOPKA KRIŽNA 10AX 250V ~

- 10AX 250V~, tip SE70
- sukladno normi EN 60669-1
- bezvijčani kontakti 1,5-2,5mm²

SWITCH INTERMEDIATE 10AX 250V~

- 10AX 250V~, type SE70
- in accordance with EN 60669-1
- plug-in contacts 1.5-2.5mm²

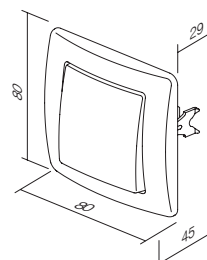
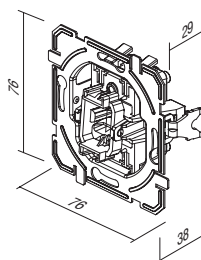

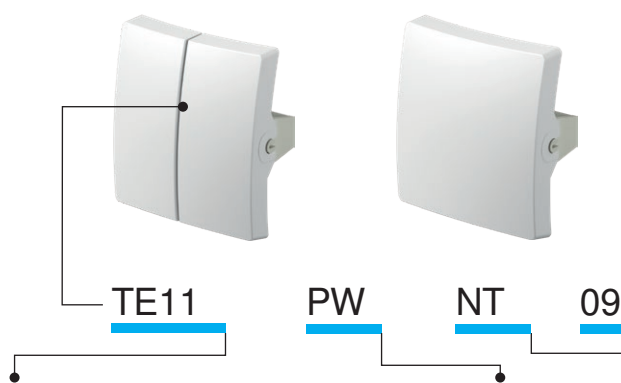

tip type	naziv description	boja colour	opcijski podaci 1 optional data 1	opcijski podaci 2 optional data 2
TE10	TIPKA OBIČNA BUTTON 1GANG	<input type="checkbox"/> PW bijela sjajna polar white	NT neutralna neutral	50
TE11	TIPKA SERIJSKA BUTTON 2GANG	<input type="checkbox"/> IW bež sjajna ivory white	IN indikator indicator	51
...	...	<input type="checkbox"/> ES srebrna mat elox silver		03
...	...	<input type="checkbox"/> CO bijeli duroplast white thermoset		04
...	...	<input type="checkbox"/> NB crna sjajna night black		

TIPKA OBIČNA



- TE10PW
- TE10IW
- TE10ES
- TE10CO
- TE10NB

- tipka zajedno s nosačem
BUTTON 1GANG
- button together with carrier



TIPKA INDIKATOR

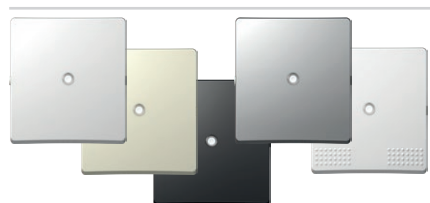

- TE10PWIN
- TE10IWIN
- TE10ESIN
- TE10COIN
- TE10NBIN

- tipka zajedno s nosačem
BUTTON INDICATOR
- button together with carrier



TIPKA S NATPISNOM PLOČICOM

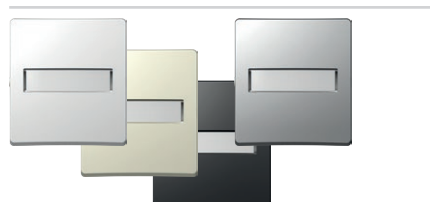

- TE13PWIL
- TE13IWIL
- TE13ESIL
- TE13NBIL

- tipka zajedno s nosačem, s natpisnom pločicom
BUTTON WITH INSCRIPTION PLATE
- button together with carrier, with inscription plate



TIPKA SERIJSKA



- TE11PW
- TE11IW
- TE11ES
- TE11CO
- TE11NB

- tipka serijska zajedno s nosačem
BUTTON 2GANG
- button 2gang together with carrier

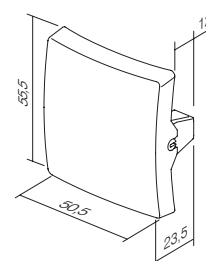
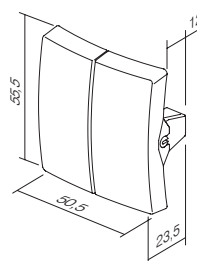

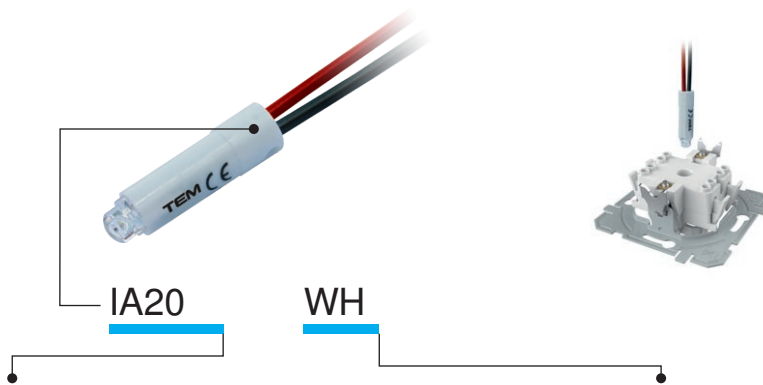

tip type	naziv description	tehnički podaci technical data	boja colour
IA10	NEONSKA TINJALICA NEON LAMP	230V~ 0,34W	<input type="checkbox"/> WH bijela white
IA20	LED TINJALICA LED LAMP	230V~ 0,40W	<input checked="" type="checkbox"/> BL plava blue
IA21	LED TINJALICA LED LAMP	24V AC/DC 0,20W	<input checked="" type="checkbox"/> RD crvena red
·	·	·	<input checked="" type="checkbox"/> GR zelena green
·	·	·	<input checked="" type="checkbox"/> OR narančasta orange

NEONSKA TINJALICA 230V~ 0,34W

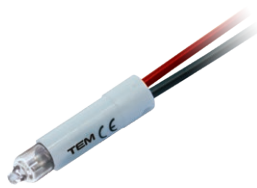
 IA10OR

- za indicaciju, osvjetljenje ili stalno osvjetljenje sklopke
- u kombinaciji s tipkom s indikatorom

NEON LAMP 230V~ 0,34W

- for indication, illumination or constant illumination of switch
- in combination with button with indicator

LED TINJALICA 230V AC/DC 0,40W

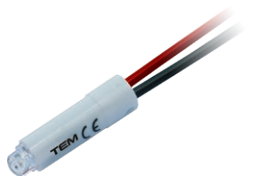

IA20WH
 IA20GR
 IA20RD
 IA20BL

- za indicaciju, osvjetljenje ili stalno osvjetljenje sklopke
- u kombinaciji s tipkom s indikatorom

LED LAMP 230V AC/DC 0,40W

- for indication, illumination or constant illumination of switch
- in combination with button with indicator

LED TINJALICA 24V AC/DC 0,20W

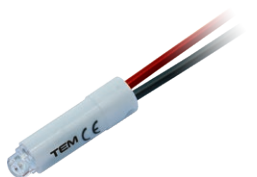

IA21WH
 IA21RD

- za indicaciju, osvjetljenje ili stalno osvjetljenje sklopke
- u kombinaciji s tipkom s indikatorom

LED LAMP 24V AC/DC 0,20W

- for indication, illumination or constant illumination of switch
- in combination with button with indicator

LED TINJALICA 12V AC/DC 0,10W



IA22WH
 IA22RD

- za indicaciju, osvjetljenje ili stalno osvjetljenje sklopke
- u kombinaciji s tipkom s indikatorom

LED LAMP 12V AC/DC 0,10W

- for indication, illumination or constant illumination of switch
- in combination with button with indicator

Indikacija /
Indication

* Rasvjetna tijela /
Illumination

Osvjetljenje stalno uključeno /
Illumination always on

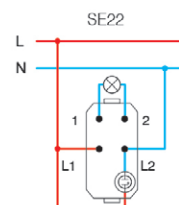
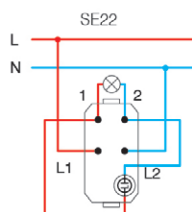
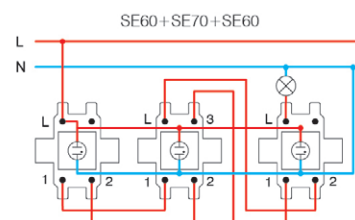
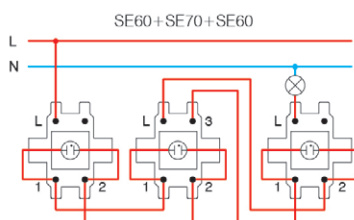
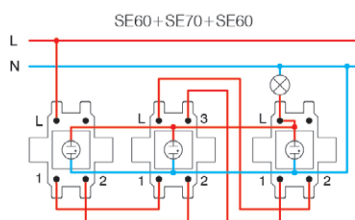
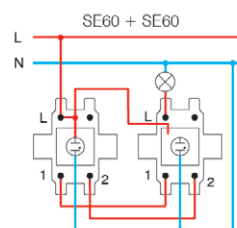
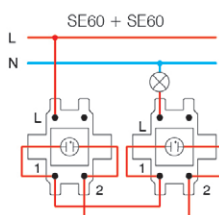
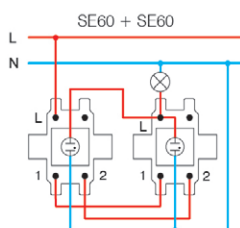
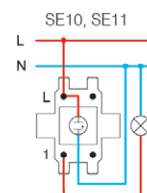
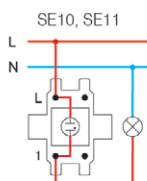
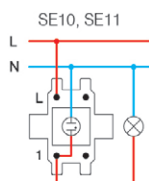

* spajanje nije prikladno za štedljive (CFL, LED) tinjalice /
the connections are not suitable for energy-saving bulbs (CFL, LED)

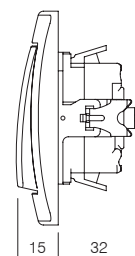

S O C K E T S V E

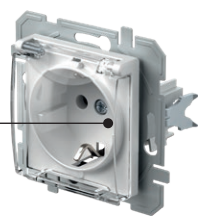

VE11



PT

XO

KS



tip type	naziv description	tehnički podaci technical data	opsijski podaci 1 optional data 1	opsijski podaci 2 optional data 2
VE10	ŠUKO UTIČNICA SOCKET SCHUKO	2P+E 16A 250V~	XO bez okvira without cover plate	KS utičnica s integriranom zaštitom shuttered live contacts
VE11	ŠUKO UTIČNICA+POKLOPAC SOCKET SCHUKO+COVER	2P+E 16A 250V~		
VE12	ŠUKO UTIČNICA SOCKET SCHUKO	2P+E 16A 250V~ BV	KS utičnica s integriranom zaštitom shuttered live contacts	
⋮	⋮	⋮		

boja
colour

<input type="checkbox"/> PW bijela sjajna polar white	<input checked="" type="checkbox"/> PT bijela+prozirna white+transparent	<input type="checkbox"/> PP bijela+bijela white+white
<input checked="" type="checkbox"/> IW bež sjajna ivory white	<input checked="" type="checkbox"/> IT bež+prozirna ivory+transparent	<input checked="" type="checkbox"/> II bež+bež ivory+ivory
<input type="checkbox"/> ES srebrna mat elox silver	<input checked="" type="checkbox"/> ST srebrna+prozirna silver+transparent	<input type="checkbox"/> SS srebrna+srebrna silver+silver
<input type="checkbox"/> CO bijeli duroplast white thermoset	<input checked="" type="checkbox"/> CT bijela+prozirna white+transparent	<input checked="" type="checkbox"/> BB crna+crna black+black
<input checked="" type="checkbox"/> NB crna sjajna night black	<input checked="" type="checkbox"/> BT crna+prozirna black+transparent	<input checked="" type="checkbox"/> RR crvena+crvena red+red
<input checked="" type="checkbox"/> RD crvena red	<input checked="" type="checkbox"/> RT crvena+prozirna red+transparent	<input checked="" type="checkbox"/> GG zelena+zelena green+green
<input checked="" type="checkbox"/> GR zelena green	<input checked="" type="checkbox"/> GT zelena+prozirna green+transparent	<input checked="" type="checkbox"/> OO narančasta+narančasta orange+orange
<input checked="" type="checkbox"/> OR narančasta orange	<input checked="" type="checkbox"/> OT narančasta+prozirna orange+transparent	



šuko – sukladno normi EN 60884-1, CEE7 (lista standarda III)

francuska – sukladno normi NF C 61-314 (lista standarda V)

šuko - in accordance with EN 60884-1, CEE7 (standard sheet III)

French - in accordance with NF C 61-314 (standard sheet V)

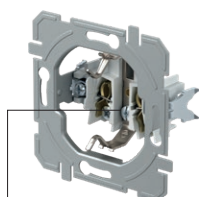
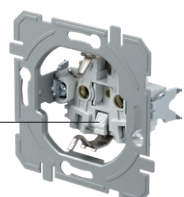
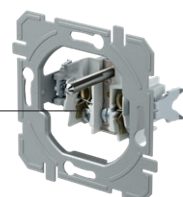
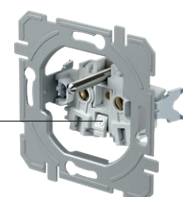
vijčano pričvršćivanje vodiča
screw contactsBV bezvijčano pričvršćivanje
BV plug-in contactsvijčano pričvršćivanje vodiča
screw contactsBV bezvijčano pričvršćivanje
BV plug-in contacts

UTIČNICA ŠUKO 2P + E 16A 250V ~ __ XO



- VE10PWXO
- VE10IWXO
- VE10ESXO
- VE10COXO
- VE10NBXO
- VE10RDXO
- VE10GRXO
- VE10ORXO

- vijčano pričvršćivanje vodiča presjeka 1,5-2,5mm²
- XO bez okvira
- 2P+E šuko
- 16A 250V~, tip VE10

SOCKET SCHUKO 2P+E 16A 250V~ __ XO

- screw contacts 1.5-2.5mm²
- XO without surround
- 2P+E schuko
- 16A 250V~, type VE10



UTIČNICA ŠUKO + POKLOPAC 2P + E 16A 250V ~ __ XO

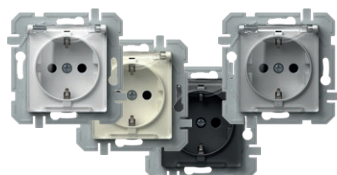

- VE11PTXO
- VE11ITXO
- VE11STXO
- VE11BTXO

- vijčano pričvršćivanje vodiča presjeka 1,5-2,5mm²
- XO bez okvira
- 2P+E šuko+poklopac
- 16A 250V~, tip VE11

SOCKET SCHUKO+COVER 2P+E 16A 250V~ __ XO

- screw contacts 1.5-2.5mm²
- XO without surround
- 2P+E schuko+cover
- 16A 250V~, type VE11



UTIČNICA ŠUKO 2P + E 16A 250V ~ BV __ XO

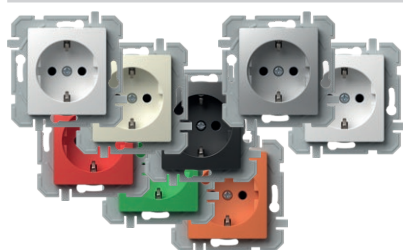

- VE12PWXO
- VE12IWXO
- VE12ESXO
- VE12COXO
- VE12NBXO
- VE12RDXO
- VE12GRXO
- VE12ORXO

- BV bezvijčani kontakti 1,5-2,5mm²
- XO bez okvira
- 2P+E šuko
- 16A 250V~, tip VE12

SOCKET SCHUKO 2P+E 16A 250V~ BV __ XO

- BV plug-in contacts 1.5-2.5mm²
- XO without surround
- 2P+E schuko
- 16A 250V~, type VE12



UTIČNICA ŠUKO + POKLOPAC 2P + E 16A 250V ~ BV __ XO

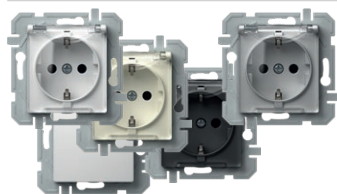

- VE13PTXO
- VE13ITXO
- VE13STXO
- VE13BTXO
- VE13PPXO

- BV bezvijčani kontakti 1,5-2,5mm²
- XO bez okvira
- 2P+E šuko+poklopac
- 16A 250V~, tip VE13

SOCKET SCHUKO+COVER 2P+E 16A 250V~ BV __ XO

- BV plug-in contacts 1.5-2.5mm²
- XO without surround
- 2P+E schuko+cover
- 16A 250V~, type VE13



UTIČNICA ŠUKO 2P + E 16A 250V ~



- VE10PW
- VE10IW
- VE10ES
- VE10CO
- VE10NB

- vijčano pričvršćivanje vodiča presjeka 1,5-2,5mm²
- 2P+E šuko
- 16A 250V~, tip VE10

SOCKET SCHUKO 2P+E 16A 250V~

- screw contacts 1.5-2.5mm²
- 2P+E schuko
- 16A 250V~, type VE10



UTIČNICA ŠUKO + POKLOPAC 2P + E 16A 250V~



- VE11PT
- VE11IT
- VE11ST
- VE11CT
- VE11BT

- vijčano pričvršćivanje vodiča presjeka 1,5-2,5mm²
- 2P+E šuko+poklopac
- 16A 250V~, tip VE11

SOCKET SCHUKO+COVER 2P+E 16A 250V~

- screw contacts 1.5-2.5mm²
- 2P+E schuko+cover
- 16A 250V~, type VE11



UTIČNICA ŠUKO 2P + E 16A 250V ~ BV



- VE12PW
- VE12IW
- VE12ES
- VE12CO
- VE12NB

- BV bezvijčani kontakti 1,5-2,5mm²
- 2P+E šuko
- 16A 250V~, tip VE12

SOCKET SCHUKO 2P+E 16A 250V~ BV

- BV plug-in contacts 1.5-2.5mm²
- 2P+E schuko
- 16A 250V~, type VE12



UTIČNICA ŠUKO + POKLOPAC 2P + E 16A 250V ~ BV



- VE13PT
- VE13IT
- VE13ST
- VE13CT
- VE13BT

- BV bezvijčani kontakti 1,5-2,5mm²
- 2P+E šuko+poklopac
- 16A 250V~, tip VE13

SOCKET SCHUKO+COVER 2P+E 16A 250V~ BV

- BV plug-in contacts 1.5-2.5mm²
- 2P+E schuko+cover
- 16A 250V~, type VE13



UTIČNICA FRANCUSKA 2P + E 16A 250V ~ __ XO

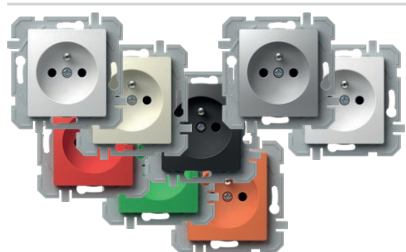

- VE40PWXO
- VE40IWXO
- VE40ESXO
- VE40COXO
- VE40NBXO
- VE40RDXO
- VE40GRXO
- VE40ORXO

- vijčano pričvršćivanje vodiča presjeka 1,5-2,5mm²
- XO bez okvira
- 2P+E francuska
- 16A 250V~, tip VE40

SOCKET FRENCH 2P+E 16A 250V~ __ XO

- screw contacts 1.5-2.5mm²
- XO without surround
- 2P+E French
- 16A 250V~, type VE40



UTIČNICA FRANCUSKA + POKLOPAC 2P + E 16A 250V~ __ XO



- VE41PTXO
- VE41ITXO
- VE41STXO
- VE41PTXO
- VE41BTXO
- VE41PPXO

- vijčano pričvršćivanje vodiča presjeka 1,5-2,5mm²
- XO bez okvira
- 2P+E francuska+poklopac
- 16A 250V~, tip VE41

SOCKET FRENCH+COVER 2P+E 16A 250V~ __ XO

- screw contacts 1.5-2.5mm²
- XO without surround
- 2P+E French+cover
- 16A 250V~, type VE41



UTIČNICA FRANCUSKA 2P + E 16A 250V~ BV __ XO

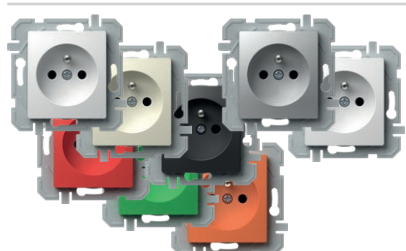

- VE42PWXO
- VE42IWXO
- VE42ESXO
- VE42COXO
- VE42NBXO
- VE42RDXO
- VE42GRXO
- VE42ORXO

- BV bezvijčani kontakti 1,5-2,5mm²
- XO bez okvira
- utičnica sa zaštitnim kontaktom francuska
- 16A 250V~, tip VE42

SOCKET FRENCH 2P+E 16A 250V~ BV __ XO

- BV plug-in contacts 1.5-2.5mm²
- XO without surround
- 2P+E French
- 16A 250V~, type VE42



UTIČNICA FRANCUSKA + POKLOPAC 2P + E 16A 250V~ BV __ XO

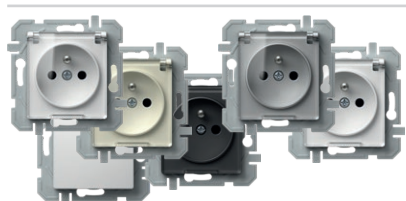

- VE43PTXO
- VE43ITXO
- VE43STXO
- VE43PTXO
- VE43BTXO
- VE43PPXO

- BV bezvijčani kontakti 1,5-2,5mm²
- XO bez okvira
- 2P+E francuska+poklopac
- 16A 250V~, tip VE43

SOCKET FRENCH+COVER 2P+E 16A 250V~ BV __ XO

- BV plug-in contacts 1.5-2.5mm²
- XO without surround
- 2P+E French+cover
- 16A 250V~, type VE43



UTIČNICA FRANCUSKA 2P + E 16A 250V ~



- VE40PW
- VE40IW
- VE40ES
- VE40CO
- VE40NB

- vijčano pričvršćivanje vodiča presjeka 1.5-2.5mm²
- 2P+E francuska
- 16A 250V~, tip VE40

SOCKET FRENCH 2P+E 16A 250V~

- screw contacts 1.5-2.5mm²
- 2P+E French
- 16A 250V~, type VE40



UTIČNICA FRANCUSKA + POKLOPAC 2P + E 16A 250V~



- VE41PT
- VE41IT
- VE41BT
- VE41ST

- vijčano pričvršćivanje vodiča presjeka 1,5-2,5mm²
- 2P+E francuska+poklopac
- 16A 250V~, tip VE41

SOCKET FRENCH+COVER 2P+E 16A 250V~

- screw contacts 1.5-2.5mm²
- 2P+E French+cover
- 16A 250V~, type VE41



UTIČNICA FRANCUSKA 2P + E 16A 250V ~ BV



- VE42PW
- VE42IW
- VE42ES
- VE42CO
- VE42NB

- BV bezvijčani kontakti 1,5-2,5mm²
- utičnica sa zaštitnim kontaktom francuska
- 16A 250V~, tip VE42

SOCKET FRENCH 2P+E 16A 250V~ BV

- BV plug-in contacts 1.5-2.5mm²
- 2P+E French
- 16A 250V~, type VE42



UTIČNICA FRANCUSKA + POKLOPAC 2P + E 16A 250V ~ BV



- VE43PT
- VE43IT
- VE43BT
- VE43ST

- BV bezvijčani kontakti 1,5-2,5mm²
- 2P+E francuska+poklopac
- 16A 250V~, tip VE43

SOCKET FRENCH+COVER 2P+E 16A 250V~ BV

- BV plug-in contacts 1.5-2.5mm²
- 2P+E French+cover
- 16A 250V~, type VE43



UTIČNICA ŠUKO DVOSTRUKA 2P + E 16A 250V~



- VE16PWKS
- VE16WKS
- VE16ESKS
- VE16NBKS

- 2P+E šuko dvostruka
- 16A 250V~, tip VE16
- sukladno normama IEC 60884-1, CEE7
- vijčano pričvršćivanje vodiča presjeka 1,5-2,5 mm²
- KS zaštita od dodira kontakta

SOCKET SCHUKO DOUBLE 2P+E 16A 250V~

- 2P+E schuko double
- 16A 250V~, type VE16
- in accordance with IEC 60884-1, CEE7
- screw contacts 1.5-2.5 mm²
- KS shuttered live contacts



UTIČNICA FRANCUSKA DVOSTRUKA 2P + E 16A 250V~



- VE46PWKS
- VE46WKS
- VE46ESKS
- VE46NBKS

- 2P + E francuska dvostruka
- 16A 250V~, tip VE46
- sukladno normama IEC 60884-1, CEE7; NF C 61-314, ČSN 33 2318; PN-E 93201
- vijčano pričvršćivanje vodiča presjeka 1,5-2,5 mm²
- KS zaštita od dodira kontakta

SOCKET FRENCH DOUBLE 2P+E 16A 250V~

- 2P+E French double
- 16A 250V~, type VE46
- in accordance with IEC 60884-1, CEE7; NF C 61-314, ČSN 33 2318; PN-E 93201
- screw contacts 1.5-2.5 mm²
- KS shuttered live contacts



UTIČNICA 2P 16A 250V ~

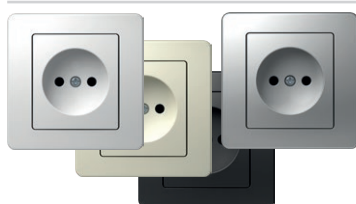

- VE30PW
- VE30IW
- VE30ES
- VE30NB

- 2P bez voda za uzemljenje
- 16A 250V ~
- sukladno normama EN 60884-1, CEE7 (lista standarda I)
- vijčano pričvršćivanje vodiča presjeka 1,5-2,5mm²

SOCKET 2P 16A 250V~

- 2P without earthing contact
- 16A 250V
- in accordance with EN 60884-1, CEE7 (standard sheet I)
- screw contacts 1.5-2.5mm²

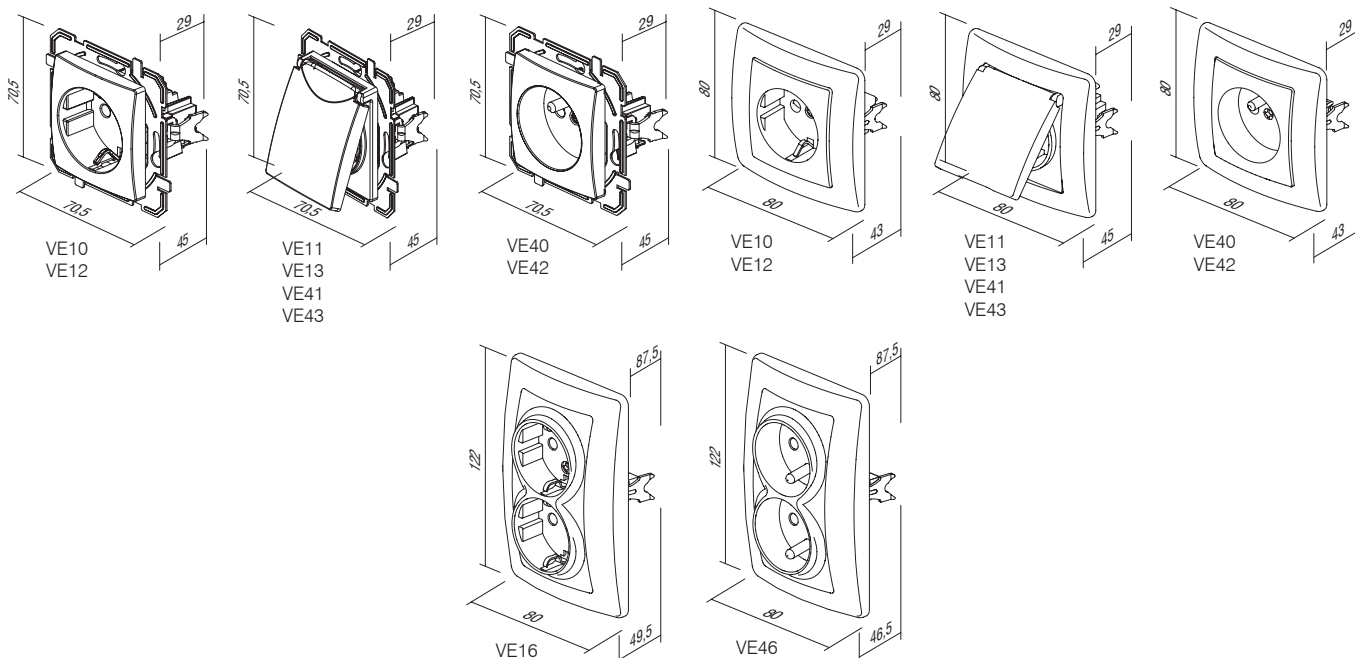



KE37

PW

tip type	naziv description	tehnički podaci technical data	boja colour
KE11	UTIČNICA TV-R ZAVRŠNA SOCKET TV-R END-LINE	1dB	<input type="checkbox"/> PW bijela sjajna polar white
KE12	UTIČNICA TV-R PROLAZNA SOCKET TV-R THROUGHPASS	10dB	<input type="checkbox"/> IW bež sjajna ivory white
KE16	UTIČNICA SAT-TV-R ZAVRŠNA SOCKET SAT-TV-R END-LINE	3dB	<input type="checkbox"/> ES srebrna mat elox silver
⋮	⋮	⋮	<input type="checkbox"/> CO bijeli duroplast white thermoset
⋮	⋮	⋮	<input type="checkbox"/> NB crna sjajna night black

UTIČNICA TV-R ZAVRŠNA 1dB



KE11

- TV-R završna
- propušta frekvenciju u rasponu 5÷862MHz
- prigušenje: R-1.5dB, TV-1dB
- sukladno normi EN 50083-1
- vijčano pričvršćivanje

SOCKET TV-R END-LINE 1dB

- TV-R end-line
- frequency range 5÷862MHz
- reduction: R-1.5dB, TV-1dB
- in accordance with EN 50083-1
- screw contacts

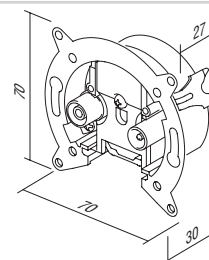
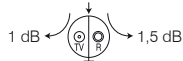

UTIČNICA TV-R PROLAZNA 10dB



KE12

- TV-R prolazna
- propušta frekvenciju u rasponu 5÷862MHz
- prigušenje: R-10dB, TV-10dB, prolaz-2dB
- sukladno normi EN 50083-1
- vijčano pričvršćivanje

SOCKET TV-R TROUGHPASS 10dB

- TV-R troughpass
- frequency range 5÷862MHz
- reduction: R-10dB, TV-10dB, trough-2dB
- in accordance with EN 50083-1
- screw contacts

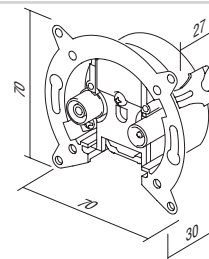
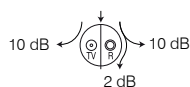

UTIČNICA SAT-TV-R ZAVRŠNA 3dB



KE16

- SAT-TV-R završna
- propušta frekvenciju u rasponu 5÷2400MHz
- prigušenje: R-1dB, TV-1.5dB, SAT-3dB
- za ugradnju u okruglu kutiju Ø60 s nožicama ili vijcima
- sukladno normi EN 50083-1
- vijčano pričvršćivanje

SOCKET SAT-TV-R END-LINE 3dB

- SAT-TV-R end-line
- frequency range 5÷2400MHz
- reduction: R-1dB, TV-1.5dB, SAT-3dB
- for mounting in round box Ø60 with claws or screws
- in accordance with EN 50083-1
- screw contacts

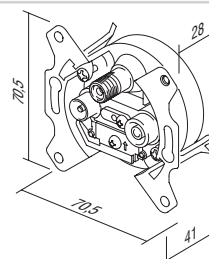
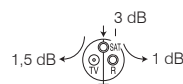

UTIČNICA TEL KS RJ11 6/4

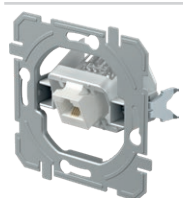

KE36

- KS keystone standard pričvršćivanja
- RJ11 6/4
- sukladno normi IEC 60603-7

SOCKET TEL KS RJ11 6/4

- KS keystone fixing standard
- RJ11 6/4
- in accordance with IEC 60603-7

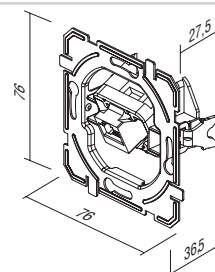

UTIČNICA CAT5e KS RJ45 8/8

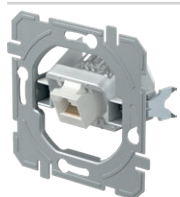

KE37

- KS keystone standard pričvršćivanja
- CAT5e, RJ45 8/8
- sukladno normi IEC 60603-7

SOCKET CAT5e KS RJ45 8/8

- KS keystone fixing standard
- CAT5e, RJ45 8/8
- in accordance with IEC 60603-7

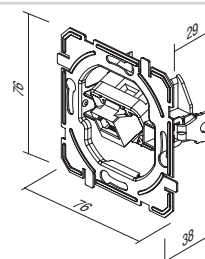

UTIČNICA CAT6s KS RJ45 8/8 SLIM

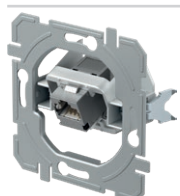

KE40

- KS keystone standard pričvršćivanja
- CAT6s, RJ45 8/8
- sukladno normi IEC 60603-7

SOCKET CAT6s KS RJ45 8/8 SLIM

- KS keystone fixing standard
- CAT6s, RJ45 8/8
- in accordance with IEC 60603-7

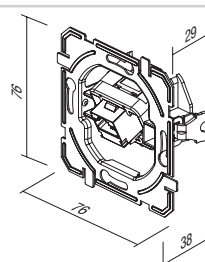

UTIČNICA TEL KS DVOSTRUKA 2x RJ11 6/4

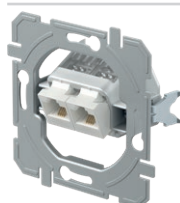

KE38

- KS keystone standard pričvršćivanja
- 2x RJ11 6/4
- sukladno normi IEC 60603-7

SOCKET TEL KS DOUBLE 2x RJ11 6/4

- KS keystone fixing standard
- 2x RJ11 6/4
- in accordance with IEC 60603-7

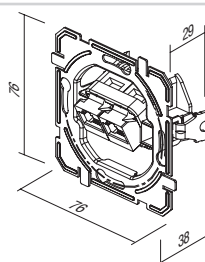

UTIČNICA CAT5e KS DVOSTRUKA 2x RJ45 8/8

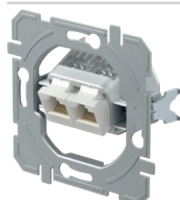

KE39

- KS keystone standard pričvršćivanja
- 2x CAT5e, RJ45 8/8
- sukladno normi IEC 60603-7

SOCKET CAT5e KS DOUBLE 2x RJ45 8/8

- KS keystone fixing standard
- 2x CAT5e, RJ45 8/8
- in accordance with IEC 60603-7

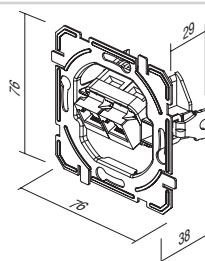

UTIČNICA CAT6s KS DVOSTRUKA 2x RJ45 8/8 SLIM

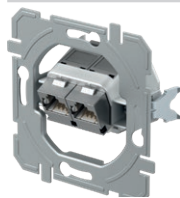

KE41

- KS keystone standard pričvršćivanja
- 2x CAT6s, RJ45 8/8
- sukladno normi IEC 60603-7

SOCKET CAT6s KS DOUBLE 2x RJ45 8/8 SLIM

- KS keystone fixing standard
- 2x CAT6s, RJ45 8/8
- in accordance with IEC 60603-7

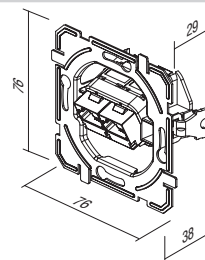

ADAPTER KS JEDNOSTRUKI

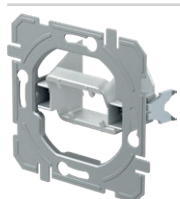

KE45

- KS keystone standard priključivanja - jednostruki
- AMP, Avaya, Brandrex, FMT, Mfico, Tyco, ...
- nije ugrađen komunikacijski modul

ADAPTER KS SINGLE

- KS keystone fixing standard - single
- AMP, Avaya, Brandrex, FMT, Mfico, Tyco, ...
- communication module not included

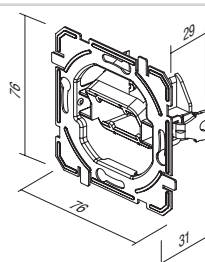

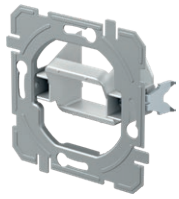

KE46

ADAPTER KS DVOSTRUKI

- KS keystone standard priključivanja - dvostruki
- AMP, Tyco, ...
- nije ugrađen komunikacijski modul

ADAPTER KS DOUBLE

- KS keystone fixing standard - double
- AMP, Tyco, ...
- communication module not included

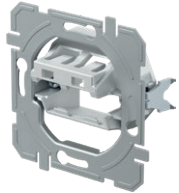
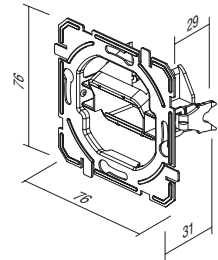

KE47

ADAPTER PD DVOSTRUKI

- standard pričvršćivanja PD Panduit Mini-COM – dvostruki
- nije ugrađen komunikacijski modul

ADAPTER PD DOUBLE

- PD Panduit Mini-COM fixing standard - double
- communication module not included

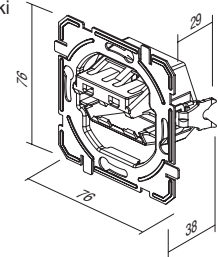

UTIČNICA TV OSNOVNA 0dB



- KE10PW
- KE10IW
- KE10ES
- KE10CO
- KE10NB

- TV osnovna
- prigušenje 0dB
- stražnji konektor – F standard

SOCKET TV BASIC 0dB

- TV basic
- reduction 0dB
- back connector – F standard



UTIČNICA TV-R ZAVRŠNA 1dB



- KE11PW
- KE11IW
- KE11ES
- KE11CO
- KE11NB

- TV-R završna
- propušta frekvenciju u rasponu 5÷862 MHz
- prigušenje: R-1.5dB, TV-1dB
- sukladno normi EN 50083-1
- vijčano pričvršćivanje

SOCKET TV-R END-LINE 1dB

- TV-R end-line
- frequency range 5÷862 MHz
- reduction: R-1.5dB, TV-1dB
- in accordance with EN 50083-1
- screw contact



UTIČNICA TV-R PROLAZNA 10dB



- KE12PW
- KE12IW
- KE12ES
- KE12CO
- KE12NB

- TV-R prolazna
- propušta frekvenciju u rasponu 5÷862 MHz
- prigušenje: R-10dB, TV-10dB, prolaz-2dB
- sukladno normi EN 50083-1
- vijčano pričvršćivanje

SOCKET TV-R TROUGHPASS 10dB

- TV-R troughpass
- frequency range 5÷862 MHz
- reduction: R-10dB, TV-10dB, trough-2dB
- in accordance with EN 50083-1
- screw contacts



UTIČNICA SAT-TV-R ZAVRŠNA 3dB



- KE16PW
- KE16IW
- KE16ES
- KE16CO
- KE16NB

- SAT-TV-R završna
- propušta frekvenciju u rasponu 5÷2400 MHz
- prigušenje: R-1dB, TV-1.5dB, SAT-3dB
- sukladno normi EN 50083-1
- vijčano pričvršćivanje

SOCKET SAT-TV-R END-LINE 3dB

- SAT-TV-R end-line
- frequency range 5÷2400 MHz
- reduction: R-1dB, TV-1.5dB, SAT-3dB
- in accordance with EN 50083-1
- screw contacts



UTIČNICA AUDIO 2xRCA



- KE22PW
- KE22IW
- KE22ES
- KE22CO
- KE22NB

- audio 2xRCA
- pričvršćivanje vodiča lemljenjem

SOCKET AUDIO 2xRCA

- audio 2xRCA
- soldering connection of cable



UTIČNICA AUDIO ZVUČNICI



- KE23PW
- KE23IW
- KE23ES
- KE23CO
- KE23NB

- audio 2x Ø4 mm
- pričvršćivanje vodiča za zvučnike umetanjem ili banana utikačem Ø4 mm
- lemljenje spojeva kabela na stražnjoj strani

SOCKET AUDIO LOUDSPEAKERS

- audio 2x Ø4mm
- to accommodate speaker wire, banana plug Ø4mm or spades
- soldering connection of cable at the back side



UTIČNICA TEL KS RJ11 6/4

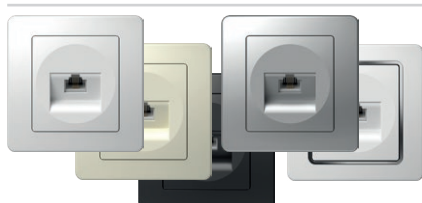

- KE36PW
- KE36IW
- KE36ES
- KE36CO
- KE36NB

- KS keystone standard pričvršćivanja
- RJ11 6/4
- sukladno normi IEC 60603-7

SOCKET TEL KS RJ11 6/4

- KS keystone fixing standard
- RJ11 6/4
- in accordance with IEC 60603-7



UTIČNICA CAT5e KS RJ45 8/8

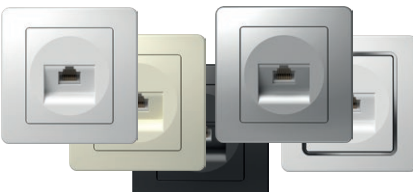

- KE37PW
- KE37IW
- KE37ES
- KE37CO
- KE37NB

- KS keystone standard pričvrščivanja
- CAT5e, RJ45 8/8
- skladno normi IEC 60603-7

SOCKET CAT5e KS RJ45 8/8

- KS keystone fixing standard
- CAT5e, RJ45 8/8
- in accordance with IEC 60603-7



UTIČNICA CAT6s KS RJ45 8/8 SLIM

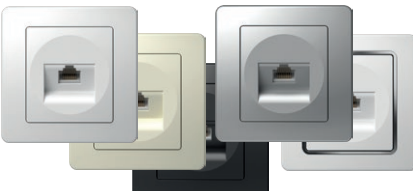

- KE40PW
- KE40IW
- KE40ES
- KE40CO
- KE40NB

- KS keystone standard pričvrščivanja
- CAT6s, RJ45 8/8
- skladno normi IEC 60603-7

SOCKET CAT6s KS RJ45 8/8 SLIM

- KS keystone fixing standard
- CAT6s, RJ45 8/8
- in accordance with IEC 60603-7



UTIČNICA TEL KS DVOSTRUKA 2x RJ11 6/4

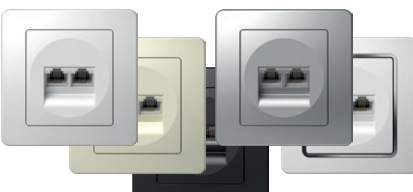

- KE38PW
- KE38IW
- KE38ES
- KE38CO
- KE38NB

- KS keystone standard pričvrščivanja
- 2x RJ11, 6/4
- skladno normi IEC 60603-7

SOCKET TEL KS DOUBLE 2x RJ11 6/4

- KS keystone fixing standard
- 2x RJ11, 6/4
- in accordance with IEC 60603-7



UTIČNICA CAT5e KS DVOSTRUKA 2x RJ45 8/8

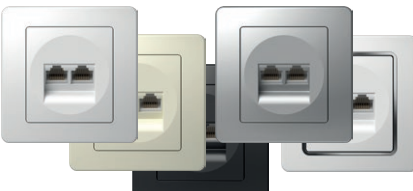

- KE39PW
- KE39IW
- KE39ES
- KE39CO
- KE39NB

- KS keystone standard pričvrščivanja
- 2x CAT5e, RJ45 8/8
- skladno normi IEC 60603-7

SOCKET CAT5e KS DOUBLE 2x RJ45 8/8

- KS keystone fixing standard
- 2x CAT5e, RJ45 8/8
- in accordance with IEC 60603-7



UTIČNICA CAT6s KS DVOSTRUKA 2x RJ45 8/8 SLIM

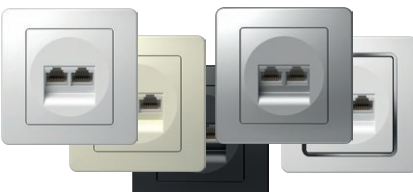

- KE41PW
- KE41IW
- KE41ES
- KE41CO
- KE41NB

- KS keystone standard pričvrščivanja
- 2x CAT6s, RJ45 8/8
- skladno normi IEC 60603-7

SOCKET CAT6s KS DOUBLE 2x RJ45 8/8 SLIM

- KS keystone fixing standard
- 2x CAT6s, RJ45 8/8
- in accordance with IEC 60603-7



UTIČNICA TEL LT RJ11 6/4

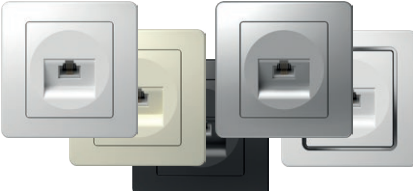

- KE35PW
- KE35IW
- KE35ES
- KE35CO
- KE35NB

- TEL LT vijak
- vijčano pričvrščivanje
- RJ11 6/4
- skladno normi IEC 60603-7

SOCKET TEL LT RJ11 6/4

- TEL LT screw
- screw contacts
- RJ11 6/4
- in accordance with IEC 60603-7

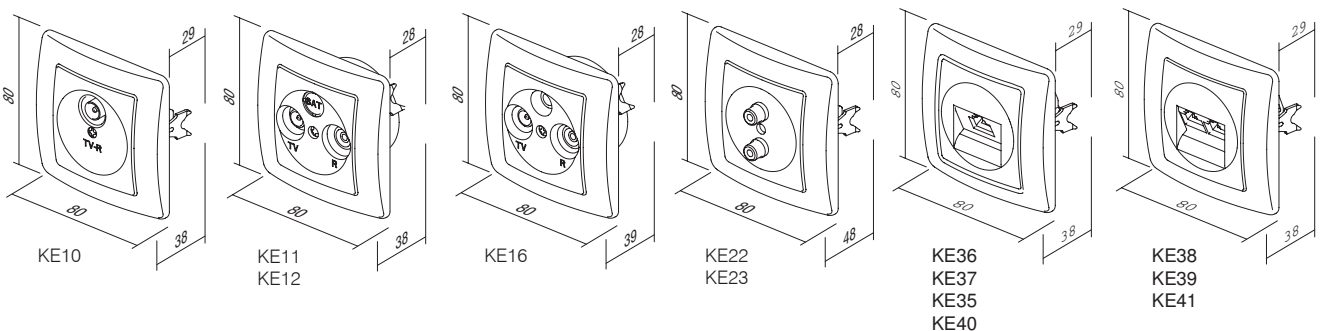

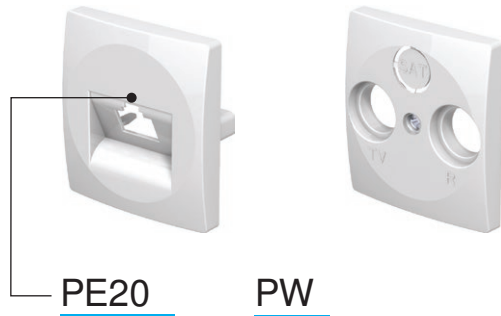
tip type	naziv description	tehnički podaci technical data	boja colour
PE10	POKLOPAC TV-R COVER TV-R	2P/3P	<input type="checkbox"/> PW bijela sjajna polar white
PE20	POKLOPAC KS JEDNOSTRUKI COVER KS SINGLE		<input type="checkbox"/> IW bež sjajna ivory white
PE21	POKLOPAC KS DVOSTRUKI COVER KS DOUBLE		<input type="checkbox"/> ES srebrna mat elox silver
⋮	⋮	⋮	<input type="checkbox"/> CO bijeli duroplast white thermoset
			<input type="checkbox"/> NB crna sjajna night black

POKLOPAC TV-R 2P/3P



- PE10PW
- PE10IW
- PE10ES
- PE10CO
- PE10NB

- poklopac TV-R, 2P ili 3P s vijkom
COVER TV-R 2P/3P
- TV-R cover, 2P or 3P with screw



POKLOPAC KS JEDNOSTRUKI

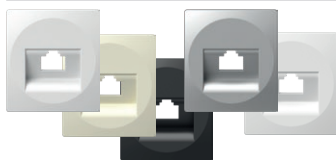

- PE20PW
- PE20IW
- PE20ES
- PE20CO
- PE20NB

- KS poklopac jednostrukim
COVER KS SINGLE
- KS cover single



POKLOPAC KS DVOSTRUKI

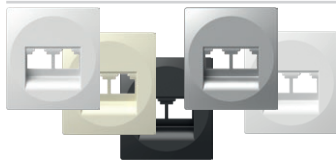

- PE21PW
- PE21IW
- PE21ES
- PE21NB

- KS poklopac dvostruki
COVER KS DOUBLE
- KS cover double



POKLOPAC TAE/TDO



- PE30PW
- PE30IW
- PE30ES
- PE30NB

- TAE ili TDO poklopac s vijkom
COVER TAE/TDO
- TAE or TDO cover with screw

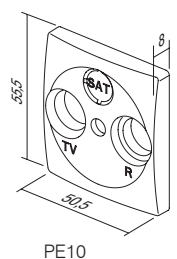
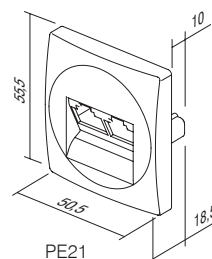
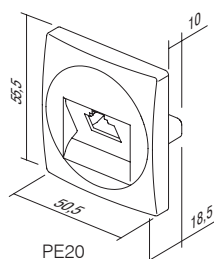
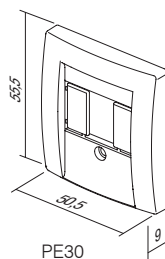



EE15

PW

tip type	naziv description	tehnički podaci technical data	boja colour
EE15	REGULATOR OSVJETLJENJA ROTACIJSKI IZMJENIČNI <i>DIMMER ROTATIVE 2WAY</i>	RL 400W	<input type="checkbox"/> PW bijela sjajna <i>polar white</i>
EE16	REGULATOR OSVJETLJENJA ROTACIJSKI IZMJENIČNI <i>DIMMER ROTATIVE 2WAY</i>	RLC 400W	<input type="checkbox"/> IW bež sjajna <i>ivory white</i>
EE19	REGULATOR OSVJETLJENJA ROTACIJSKI IZMJENIČNI <i>DIMMER ROTATIVE 2WAY</i>	LED 100W	<input type="checkbox"/> ES srebrna mat <i>elox silver</i>
⋮	⋮	⋮	<input type="checkbox"/> CO bijeli duroplast <i>white thermoset</i>
⋮	⋮	⋮	<input type="checkbox"/> NB crna sjajna <i>night black</i>

REGULATOR OSVJETLJENJA ROTACIJSKI IZMJENIČNI RL 400W



EE15

- rotacijski s izmjeničnom sklopkom
- opterećenje RL, 40W – 400W
- moguća je kombinacija s izmjeničnom sklopkom
- povezivanje više regulatora osvjetljenja nije dopušteno
- sukladno normama EN 60669-1 i EN 60669-2-1
- bezvijačani kontakti 1,5mm²
- napajanje 230V ~ 50Hz
- unutarnji promjer tipke Ø6 mm
- priložen zamjenjivi osigurač

DIMMER ROTATIVE 2WAY RL 400W

- rotation control with 2-way switch
- load RL, 40W - 400W
- 2-way switch combination is possible
- more dimmers combination is not allowed
- in accordance with EN 60669-1 and EN 60669-2-1
- plug-in contacts 1.5mm²
- supply 230V~ 50Hz
- button inner diameter Ø6mm
- replaceable fuse included

REGULATOR OSVJETLJENJA ROTACIJSKI IZMJENIČNI RLC 400W



EE16

- rotacijski s izmjeničnom sklopkom
- opterećenje RLC, 20W – 400W
- moguća je kombinacija s izmjeničnom sklopkom
- povezivanje više regulatora osvjetljenja nije dopušteno
- sukladno normama EN 60669-1 i EN 60669-2-1
- bezvijačani kontakti 1,5mm²
- unutarnji promjer tipke Ø6 mm
- napajanje 230V ~ 50Hz
- elektronski osigurač

DIMMER ROTATIVE 2WAY RLC 400W

- rotation control with 2-way switch
- load RLC, 20W - 400W
- 2-way switch combination is possible
- more dimmers combination is not allowed
- in accordance with EN 60669-1 and EN 60669-2-1
- plug-in contacts 1.5mm²
- supply 230V~ 50Hz
- button inner diameter Ø6mm
- electronic fuse



EE19

REGULATOR OSVJETLJENJA ROTACIJSKI IZMJENIČNI LED 100W

- rotacijski s izmjeničnom sklopkom
- opterećenje: LED, 0-100W (maks. 10 LED)
- GLS, 10-250W
- moguća je kombinacija s izmjeničnom sklopkom
- povezivanje više regulatora osvjetljenja nije dopušteno
- sukladno normama EN 60669-1 i EN 60669-2-1
- bezvijčani kontakti 1,5mm²
- napajanje 230V ~ 50Hz
- priložen zamjenjivi osigurač
- unutarnji promjer tipke Ø6 mm

DIMMER ROTATIVE 2WAY LED 100W

- rotation control with 2-way switch
- load: LED, 0-100W (max. 10 LEDs)
- GLS, 10-250W
- 2-way switch combination is possible
- more dimmers combination is not allowed
- in accordance with EN 60669-1 and EN 60669-2-1
- plug-in contacts 1.5mm²
- supply 230V~ 50Hz
- replaceable fuse included
- button inner diameter Ø6mm

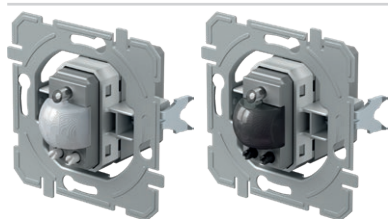
 EE32A1
 EE32A2

IR SKLOPKA 5A 230V~

- IR infracrvena sklopka
- napajanje: 230V~ ± 10% 50Hz
- relej: 5A / 250V~ (zero crossing)
- zaštitna razina: IP40
- presjek žica na kontaktnom terminalu: 0,75 - 2,5 mm²
- kut prepoznavanja: do 110° pri 20 °C
- raspon prepoznavanja: približno 8m pri 20 °C
- prilagodljivost trajanja: od približno 5 s do 12 min
- prilagodljivost osvjetljenja: od približno 5 do 200 LUX
- temperatura radnog okruženja: od 0 °C do +40 °C
- nije prikladno za ugradnju u kutije duboke 45 mm
- samo za unutrašnju uporabu

IR SWITCH 5A 230V~

- IR infrared switch
- supply voltage: 230V~ ±10 % 50Hz
- relay: 5A / 250V~ (zero crossing)
- protection rating: IP40
- cross-section of wires at the contact terminal: 0.75 - 2.5 mm²
- detection angle: up to 110° at 20°C
- detection area: approx. 8 m at 20°C
- adjustability of duration: from approx. 5 s to 12 min
- adjustability of brightness: from approx. 5 to 200 LUX
- operating temperature: from 0°C to +40°C
- not suitable for installation in 45 mm deep boxes
- only for indoor usage

 EE67

USB PUNJAČ 5 V 2,4 A

- za punjenje elektroničkih uređaja preko standardnog USB priključka (sukladno i s Apple uređajima)
- napajanje: 100 – 230 V~ 50/60 Hz
- potrošnja energije: 300 mA pri 100 V~ / 150 mA pri 230 V~
- potrošnja pri mirovanju: 30 mW pri 230 V~
- nazivni izlazni napon: 5 VCD (± 5 %) SELV
- njihanje (ripple) izlaznog napona: 150 mV
- nazivna izlazna snaga: 2,4 A (±10 %)
- vrsta konektora: USB A / USB A
- učinkovitost: maks. 77 %
- radna temperatura: 0 °C / +45 °C (unutrašnja uporaba)
- IP zaštitni razred: IP20, samo za unutrašnju uporabu
- sigurnosni razred uređaja II
- prenaponska kategorija (EN 62109): Klasa III
- vijčano pričvršćivanje vodiča presjeka maks. 2,5 mm²
- uređaj s razmakom kontakta od najmanje 3 mm
- sukladno standardu EN 60950-1 te LVD i EMC direktivama

USB POWER SUPPLY UNIT 5V 2.4A

- for charging electronic devices via a standard USB port (also compatible with Apple devices)
- power supply: 100-230V~ 50/60Hz
- power consumption: 300mA at 100V~/150mA at 230V~
- standby power consumption: 30mW at 230V~
- nominal output voltage: 5 VCD (± 5%) SELV
- output ripple voltage: 150mV
- nominal output current: 2.4A (±10%)
- connector type: USB A / USB A
- efficiency: maximum of 77%
- operating temperature: 0°C/+45°C (indoor use)
- IP protection class: IP20, indoor use only
- class device II
- overvoltage category (EN 62109): Class III
- screw contacts: max. 2.5 mm²
- device with a contact gap of at least 3mm
- in accordance with the EN 60950-1 and LVD & EMC directives



- EE15PW
- EE15IW
- EE15ES
- EE15CO
- EE15NB

REGULATOR OSVJETLJENJA ROTACIJSKI IZMJENIČNI RL 400W

- rotacijski s izmjeničnom sklopkom
- opterećenje RL, 40W – 400W
- moguća je kombinacija s izmjeničnom sklopkom
- povezivanje više regulatora osvjetljenja nije dopušteno
- sukladno normama EN 60669-1 i EN 60669-2-1
- bezvličani kontakti 1,5mm²
- napajanje 230V ~ 50Hz
- priložen zamjenjivi osigurač



DIMMER ROTATIVE 2WAY RL 400W

- rotation control with 2-way switch
- load RL, 40W - 400W
- 2-way switch combination is possible
- more dimmers combination is not allowed
- in accordance with EN 60669-1 and EN 60669-2-1
- plug-in contacts 1.5mm²
- supply 230V~ 50Hz
- replaceable fuse included

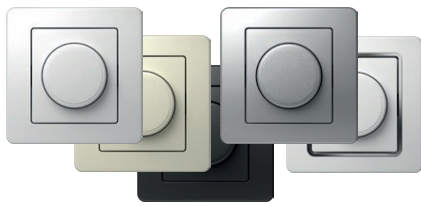

- EE16PW
- EE16IW
- EE16ES
- EE16CO
- EE16NB

REGULATOR OSVJETLJENJA ROTACIJSKI IZMJENIČNI RLC 400W

- rotacijski s izmjeničnom sklopkom
- opterećenje RLC, 20W – 400W
- moguća je kombinacija s izmjeničnom sklopkom
- povezivanje više regulatora osvjetljenja nije dopušteno
- sukladno normama EN 60669-1 i EN 60669-2-1
- bezvličani kontakti 1,5mm²
- napajanje 230V ~ 50Hz
- elektronski osigurač



DIMMER ROTATIVE 2WAY RLC 400W

- rotation control with 2-way switch
- load RLC, 20W - 400W
- 2-way switch combination is possible
- more dimmers combination is not allowed
- in accordance with EN 60669-1 and EN 60669-2-1
- plug-in contacts 1.5mm²
- supply 230V~ 50Hz
- electronic fuse



- EE19PW
- EE19IW
- EE19ES
- EE19CO
- EE19NB

REGULATOR OSVJETLJENJA ROTACIJSKI IZMJENIČNI LED 100W

- rotacijski s izmjeničnom sklopkom
- opterećenje: LED, 0-100W (maks. 10 LED)
- GLS, 10-250W
- moguća je kombinacija s izmjeničnom sklopkom
- povezivanje više regulatora osvjetljenja nije dopušteno
- sukladno normama EN 60669-1 i EN 60669-2-1
- bezvličani kontakti 1,5mm²
- napajanje 230V ~ 50Hz
- priložen zamjenjivi osigurač



DIMMER ROTATIVE 2WAY LED 100W

- rotation control with 2-way switch
- load: LED, 0-100W (max. 10 LEDs)
- GLS, 10-250W
- 2-way switch combination is possible
- more dimmers combination is not allowed
- in accordance with EN 60669-1 and EN 60669-2-1
- plug-in contacts 1.5mm²
- supply 230V~ 50Hz
- replaceable fuse included



- EE32PW
- EE32IW
- EE32ES
- EE32CO
- EE32NB

IR SKLOPKA 5A 230V~

- IR infracrvena sklopka
- napajanje: 230V~ ± 10% 50Hz
- relej: 5A / 250V~ (zero crossing)
- zaštitna razina: IP40
- presjek žica na kontaktnom terminalu: 0,75 - 2,5 mm²
- kut prepoznavanja: do 110° pri 20 °C
- raspon prepoznavanja: približno 8m pri 20 °C
- prilagodljivost trajanja: od približno 5 s do 12 min
- prilagodljivost osvjetljenja: od približno 5 do 200 LUX
- temperatura radnog okruženja: od 0 °C do +40 °C
- nije prikladno za ugradnju u kutije duboke 45 mm
- samo za unutrašnju uporabu



IR SWITCH 5A 230V~

- IR infrared switch
- supply voltage: 230V~ ±10 % 50Hz
- relay: 5A / 250V~ (zero crossing)
- protection rating: IP40
- cross-section of wires at the contact terminal: 0.75 - 2.5 mm²
- detection angle: up to 110° at 20°C
- detection area: approx. 8 m at 20°C
- adjustability of duration: from approx. 5 s to 12 min
- adjustability of brightness: from approx. 5 to 200 LUX
- operating temperature: from 0°C to +40°C
- not suitable for installation in 45 mm deep boxes
- only for indoor usage



- EE67PW
- EE67IW
- EE67NB
- EE67ES

USB PUNJAČ 5 V 2,4 A

- za punjenje elektroničkih uređaja preko standardnog USB priključka (sukladno i s Apple uređajima)
- napajanje: 100 – 230 V~ 50/60 Hz
- potrošnja energije: 300 mA pri 100 V~ / 150 mA pri 230 V~
- potrošnja pri mirovanju: 30 mW pri 230 V~
- nazivni izlazni napon: 5 VCD ($\pm 5\%$) SELV
- njihanje (ripple) izlaznog napona: 150 mV
- nazivna izlazna snaga: 2,4 A ($\pm 10\%$)
- vrsta konektora: USB A / USB A
- učinkovitost: maks. 77 %
- radna temperatura: 0 °C / +45 °C (unutrašnja uporaba)
- IP zaštitni razred: IP20, samo za unutrašnju uporabu
- sigurnosni razred uređaja II
- prenaponska kategorija (EN 62109): Klasa III
- vijčano pričvršćivanje vodiča presjeka maks. 2,5 mm²
- uređaj s razmakom kontakta od najmanje 3 mm
- sukladno standardu EN 60950-1 te LVD i EMC direktivama



USB POWER SUPPLY UNIT 5V 2.4A

- for charging electronic devices via a standard USB port (also compatible with Apple devices)
- power supply: 100-230V~ 50/60Hz
- power consumption: 300mA at 100V~/150mA at 230V~
- standby power consumption: 30mW at 230V~
- nominal output voltage: 5 VCD ($\pm 5\%$) SELV
- output ripple voltage: 150mV
- nominal output current: 2.4A ($\pm 10\%$)
- connector type: USB A / USB A
- efficiency: maximum of 77%
- operating temperature: 0°C/+45°C (indoor use)
- IP protection class: IP20, indoor use only
- class device II
- overvoltage category (EN 62109): Class III
- screw contacts: max. 2.5 mm²
- device with a contact gap of at least 3mm
- in accordance with the EN 60950-1 and LVD & EMC directives

EE15, EE16, EE19

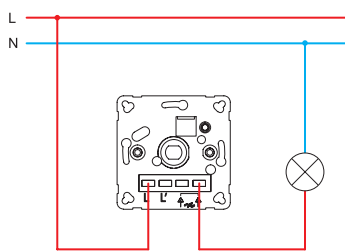

EE15, EE16, EE19

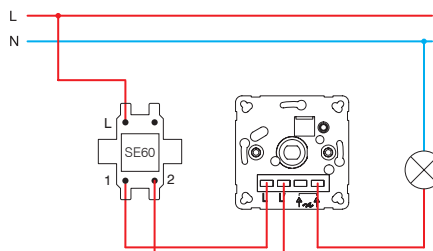

EE15, EE16, EE19

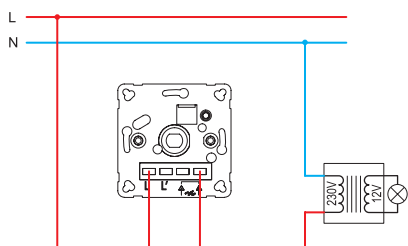

EE15, EE16, EE19

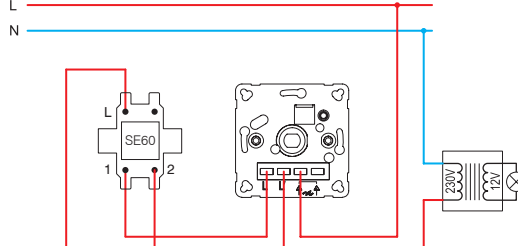

EE16, EE19

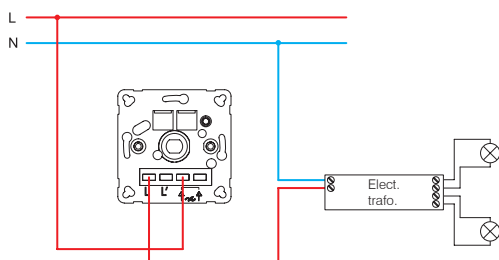

EE16, EE19

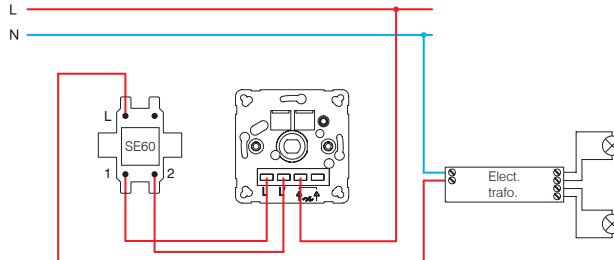

EE15 (40÷400W)

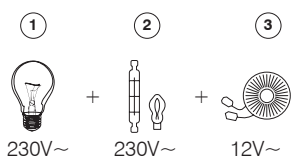

- 1 - žarulja sa žarnom niti /
incandescent lamp
2 - halogena žarulja /
halogen lamp

EE16 (20÷400W)

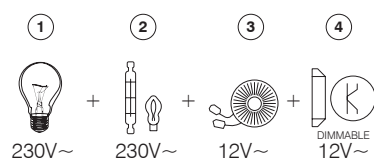

- 3 - klasični transformator /
classical transformer
4 - elektronički transformator s regulatorom osvijetljenja /
dimmable electronic transformer

EE19 (GLS 10÷250W ; LED 0÷100W)

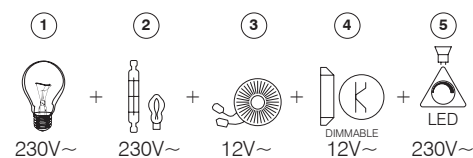

- 5 - LED tinjalica s regulacijom osvijetljenja /
dimmable LED lamp

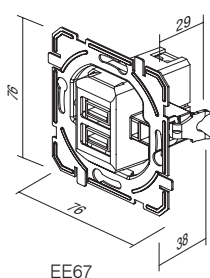

EE67

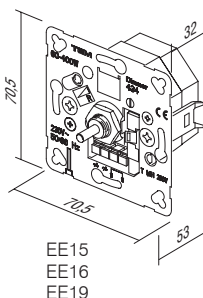
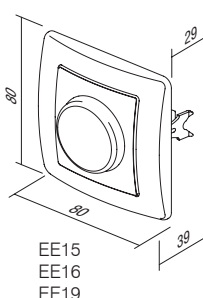
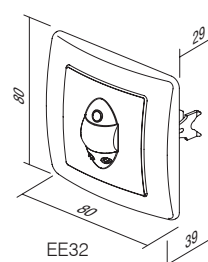
EE15
EE16
EE19EE15
EE16
EE19

EE32



PE41

PW

tip type	naziv description	boja colour
PE41	POKLOPAC REGULATORA OSVJETLJENJA COVER DIMMER	<input type="checkbox"/> PW bijela sjajna <i>polar white</i> <input type="checkbox"/> IW bež sjajna <i>ivory white</i> <input type="checkbox"/> ES srebrna mat <i>elox silver</i> <input type="checkbox"/> CO bijeli duroplast <i>white thermoset</i> <input type="checkbox"/> NB crna sjajna <i>night black</i>

POKLOPAC REGULATORA OSVJETLJENJA Ø6



- PE41PW
- PE41IW
- PE41NB
- PE41ES
- PE41CO

- poklopac regulatora osvjetljenja Ø6 mm
- za EE15, EE16, EE19

COVER DIMMER Ø6
- cover dimmer Ø6mm
- for EE15, EE16, EE19



POKLOPAC IR SKLOPKA



- PE32PW
- PE32IW
- PE32NB
- PE32ES

- poklopac IR sklopka

COVER IR SWITCH
- cover IR switch



POKLOPAC USB PUNJAČA



- PE67PW
- PE67IW
- PE67NB
- PE67ES

- poklopac USB punjača

USB SUPPLY UNIT COVER
- USB supply unit cover

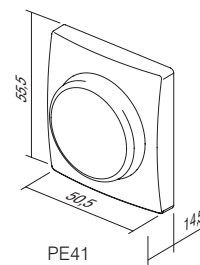
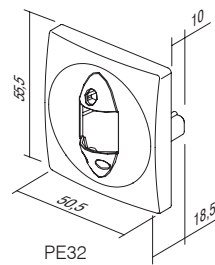
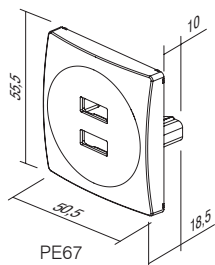

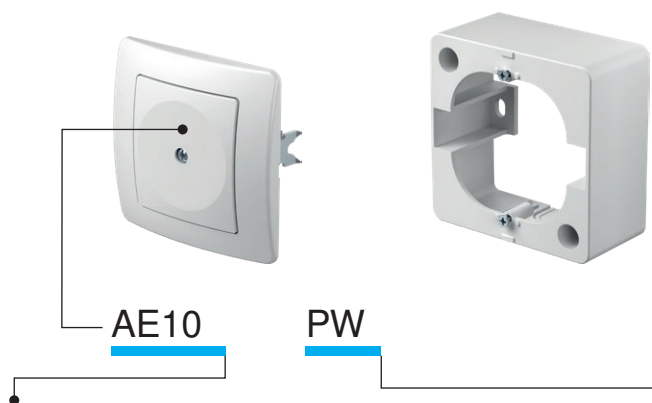

tip type	naziv description	boja colour
AE10	SLIJEPI ELEMENT BLANK	<input type="checkbox"/> PW bijela sjajna polar white
AE20	PRIKLJUČNA KUTIJA 3P + N + E 5X4mm ² CONNECTION BOX 3P+N+E 5X4mm ²	<input type="checkbox"/> IW bež sjajna ivory white
AE30	NADŽBUKNA KUTIJA SURFACE MOUNT BOX	<input type="checkbox"/> ES srebrna mat elox silver
⋮	⋮	<input type="checkbox"/> CO bijeli duroplast white thermoset
⋮	⋮	<input type="checkbox"/> NB crna sjajna night black

SLIJEPI ELEMENT



- AE10PW
- AE10IW
- AE10NB
- AE10ES
- AE10CO

- za pokrivanje praznog prostora

BLANK

- for filling up empty spaces

PRIKLJUČNA KUTIJA 5-POLNA 3P + N + E 5x4mm²

- AE20PW
- AE20IW

- priključna kutija 3P+N+E

- 16A 400V ~

- sukladno normi VDE 0606-1:2000

- vijčano pričvršćivanje vodiča presjeka 1,5-4mm²CONNECTION BOX 5POLE 3P+N+E 5x4mm²

- 3P+N+E connection box

- 16A 400V ~

- in accordance with VDE 0606-1:2000

- screw contacts 1.5-4mm²

NADŽBUKNA KUTIJA 1

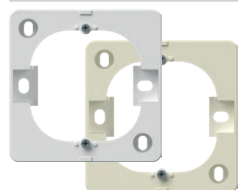

- AE30PW
- AE30IW

- nadžbukna kutija

SURFACE MOUNT BOX 1

- surface mounting box



NADŽBUKNA KUTIJA ZA DVOSTRUKU UTIČNICU EKONOMIK

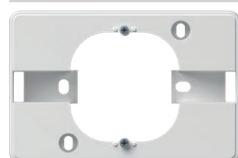

- AE31PW

- nadžbukna kutija

SURFACE MOUNT BOX FOR

EKONOMIK DOUBLE SOCKET

- surface mounting box



ZIDNI ŠTITNIK

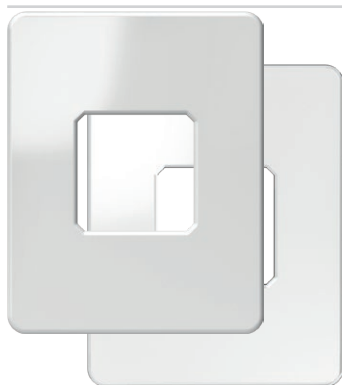

- AE50PW
- AE50TS

- štiti površinu oko utičnice ili sklopke

WALL PROTECTION

- protects surface around socket or switch

ZAŠTITA ZA DJECU KS



- AE51PW
- AE51IW

- KS dodatna zaštita za djecu od dodira kontakta

CHILD PROTECTION KS

- KS additional child protection insert - shuttered live contacts

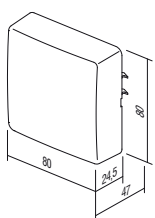

AE20

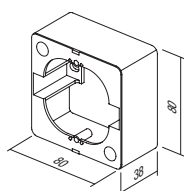

AE30

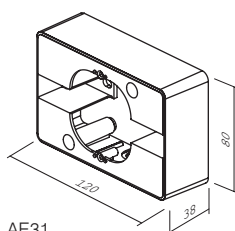

AE31

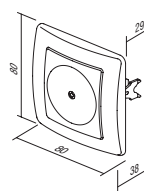

AE10

S U R R O U N D S O E

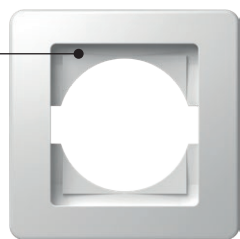

OE10



PW

tip type	naziv description	boja colour
OE10	OKVIR EKONOMIK 1 SURROUND EKONOMIK 1	<input type="checkbox"/> PW bijela sjajna polar white
OE20	OKVIR EKONOMIK 2 VODORAVNI SURROUND EKONOMIK 2 HORIZONTAL	<input type="checkbox"/> IW bež sjajna ivory white
OE30	OKVIR EKONOMIK 3 VODORAVNI SURROUND EKONOMIK 3 HORIZONTAL	<input type="checkbox"/> ES srebrna mat elox silver
⋮	⋮	<input type="checkbox"/> CO bijeli duroplast white thermoset
⋮	⋮	<input type="checkbox"/> NB crna sjajna night black

OKVIR EKONOMIK 1



- OE10PW
- OE10IW
- OE10ES
- OE10CO
- OE10NB

- dekorativni pojedinačni okvir
- sukladno normi EN 60669-1

SURROUND EKONOMIK 1
- decorative surround 1-gang
- in accordance with EN 60669-1

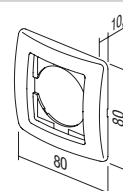

OKVIR EKONOMIK 2 VODORAVNI



- OE20PW
- OE20IW
- OE20ES
- OE20CO
- OE20NB

- dekorativni dvostruki okvir vodoravni
- sukladno normi EN 60669-1

SURROUND EKONOMIK 2 HORIZONTAL
- decorative surround 2-gang horizontal
- in accordance with EN 60669-1

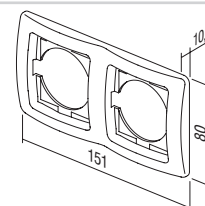

OKVIR EKONOMIK 2 OKOMITI



- OE21PW
- OE21IW
- OE21ES
- OE21CO
- OE21NB

- dekorativni dvostruki okvir okomiti
- sukladno normi EN 60669-1

SURROUND EKONOMIK 2 VERTICAL
- decorative surround 2-gang vertical
- in accordance with EN 60669-1

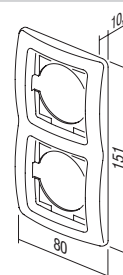

OKVIR EKONOMIK 3 VODORAVNI



- OE30PW
- OE30IW
- OE30ES
- OE30CO
- OE30NB

- dekorativni trostruki okvir vodoravni
- sukladno normi EN 60669-1

SURROUND EKONOMIK 3 HORIZONTAL
- decorative surround 3-gang horizontal
- in accordance with EN 60669-1

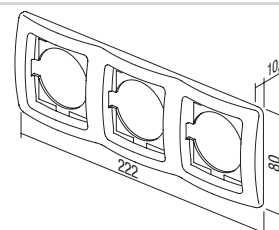



- OE31PW
- OE31IW
- OE31ES
- OE31CO
- OE31NB

OKVIR EKONOMIK 3 OKOMITI

- dekorativni trostruki okvir okomiti
- sukladno normi EN 60669-1

SURROUND EKONOMIK 3 VERTICAL

- decorative surround 3-gang vertical
- in accordance with EN 60669-1

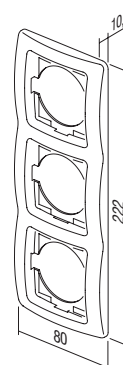

- OE40PW
- OE40IW
- OE40ES
- OE40NB

OKVIR EKONOMIK 4 VODORAVNI

- dekorativni četverostruki okvir vodoravni
- sukladno normi EN 60669-1

SURROUND EKONOMIK 4 HORIZONTAL

- decorative surround 4-gang horizontal
- in accordance with EN 60669-1

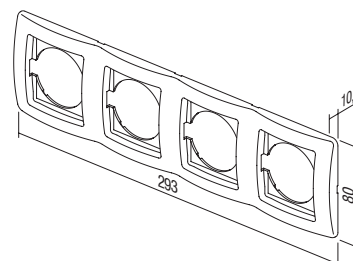

- OE41PW
- OE41IW
- OE41ES
- OE41NB

OKVIR EKONOMIK 4 OKOMITI

- dekorativni četverostruki okvir okomiti
- sukladno normi EN 60669-1

SURROUND EKONOMIK 4 VERTICAL

- decorative surround 4-gang vertical
- in accordance with EN 60669-1

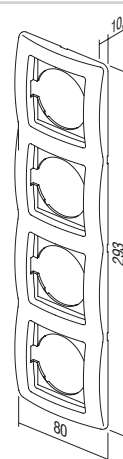

- OE50PW
- OE50IW
- OE50ES
- OE50NB

OKVIR EKONOMIK 5 VODORAVNI

- dekorativni peterostruki horizontalni okvir
- sukladno normi EN 60669-1

SURROUND EKONOMIK 5 HORIZONTAL

- decorative surround 5-gang horizontal
- in accordance with EN 60669-1

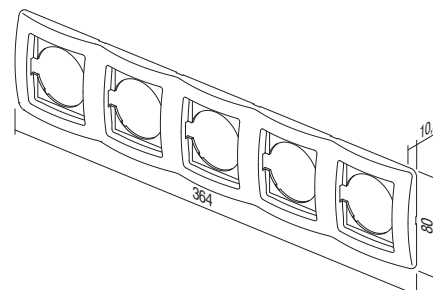

DEKORATIVNI UMETCI U BOJI /
 COLOR DECORATIVE FRAMES



OE90GR	ZELENI / GREEN	OE90YL	ŽUTI / YELLOW	OE90MB	MET. PLAVI / MET. BLUE
OE90BL	PLAVI / BLUE	OE90WH	BIJELI / WHITE	OE90BZ	BRONČANI / BRONZE
OE90VO	LJUBIČASTI / VIOLET	OE90GY	SIVI / GREY	OE90CR	SREBRNI / SILVER
OE90PI	RUŽIČASTI / PINK	OE90BK	CRNI / BLACK	OE90GO	ZLATNI / GOLD
OE90RD	CRVENI / RED				





fontana



TEM



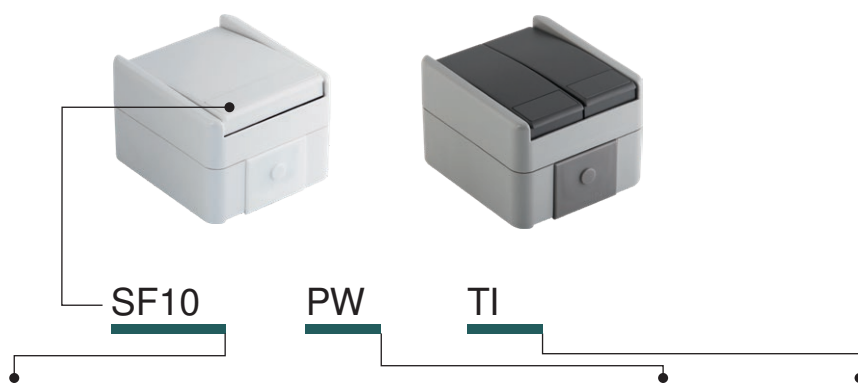

tip type	naziv description	tehnički podaci technical data	boja colour	opcijski podaci 1 optional data 1
SF10	SKLOPKA JEDNOPOLNA SWITCH 1WAY	IP44 10AX 250V~	<input type="checkbox"/> PW bijela mat (RAL 9016) white-mat	TI neonska tinjalica + indikator neon lamp+indication
SF11	TIPKALO JEDNOPOLNO PUSH BUTTON 1WAY	IP44 10A 250V~	<input type="checkbox"/> GY mat siva grey-mat	
SF20	SKLOPKA DVOPOLNA SWITCH 2POLE	IP44 10AX 250V~		
:	:	:		
:	:	:		

SKLOPKA JEDNOPOLNA IP44 10AX 250V ~



- SF10PW
- SF10GY

- 10AX 250V~, tip SF10
- sukladno normi EN 60669-1
- bezvijačani kontakti 1,5-2,5mm²
SWITCH 1WAY IP44 10AX 250V~
- 10AX 250V~, type SF10
- in accordance with EN 60669-1
- plug-in contacts 1.5-2.5mm²



SKLOPKA JEDNOPOLNA IP44 10AX 250V ~ __ TI



- SF10PWTI
- SF10GYTI

- TI indikator + neonska tinjalica
- 10AX 250V~, tip SF10
- sukladno normi EN 60669-1
- bezvijačani kontakti 1,5-2,5mm²
SWITCH 1WAY IP44 10AX 250V~ __ TI
- TI indicator+neon lamp
- 10AX 250V~, type SF10
- in accordance with EN 60669-1
- plug-in contacts 1.5-2.5mm²



TIPKALO JEDNOPOLNO IP44 10A 250V~ __ TI



- SF11PWTI
- SF11GYTI

- TI indikator + neonska tinjalica
- 10A 250V~, tip SF11
- sukladno normi EN 60669-1
- bezvijačani kontakti 1,5-2,5mm²
PUSH BUTTON 1WAY IP44 10A 250V~ __ TI
- TI indicator+neon lamp
- 10A 250V~, type SF11
- in accordance with EN 60669-1
- plug-in contacts 1.5-2.5mm²



SKLOPKA DVOPOLNA IP44 10AX 250V ~



- SF20PW
- SF20GY

- 10AX 250V~, tip SF20
- sukladno normi EN 60669-1
- bezvijačani kontakti 1,5-2,5mm²
SWITCH 2POLE IP44 10AX 250V~
- 10AX 250V~, type SF20
- in accordance with EN 60669-1
- plug-in contacts 1.5-2.5mm²





- SF50PW
- SF50GY

SKLOPKA SERIJSKA JEDNOPOLNA IP44 10AX 250V ~

- 10AX 250V~, tip SF50
- sukladno normi EN 60669-1
- bezvijčani kontakti 1,5-2,5mm²

SWITCH 2GANG-1WAY IP44 10AX 250V~

- 10AX 250V~, type SF50
- in accordance with EN 60669-1
- plug-in contacts 1.5-2.5mm²



- SF51PW
- SF51GY

TIPKALO SERIJSKO JEDNOPOLNO IP44 10A 250V ~

- 10A 250V~, tip SF51
- sukladno normi EN 60669-1
- bezvijčani kontakti 1,5-2,5mm²

PUSH BUTTON 2GANG-1WAY IP44 10A 250V~

- 10A 250V~, type SF51
- in accordance with EN 60669-1
- plug-in contacts 1.5-2.5mm²



- SF60PW
- SF60GY

SKLOPKA IZMJENIČNA IP44 10AX 250V ~

- 10AX 250V~, tip SF60
- sukladno normi EN 60669-1
- bezvijčani kontakti 1,5-2,5mm²

SWITCH 2WAY IP44 10AX 250V~

- 10AX 250V~, type SF60
- in accordance with EN 60669-1
- plug-in contacts 1.5-2.5mm²



- SF60PWTI
- SF60GYTI

SKLOPKA IZMJENIČNA IP44 10AX 250V ~ TI

- TI indikator + neonska tinjalica
- 10AX 250V~, tip SF60
- sukladno normi EN 60669-1
- bezvijčani kontakti 1,5-2,5mm²

SWITCH 2WAY IP44 10AX 250V~ TI

- TI indikator+neon lamp
- 10AX 250V~, type SF60
- in accordance with EN 60669-1
- plug-in contacts 1.5-2.5mm²



- SF63PW
- SF63GY

SKLOPKA IZMJENIČNA DVOSTRUKA IP44 10AX 250V ~

- 10AX 250V~, tip SF63
- sukladno normi EN 60669-1
- bezvijčani kontakti 1,5-2,5mm²

SWITCH 2WAY DOUBLE IP44 10AX 250V~

- 10AX 250V~, type SF63
- in accordance with EN 60669-1
- plug-in contacts 1.5-2.5mm²



- SF70PW
- SF70GY

SKLOPKA KRIŽNA IP44 10AX 250V ~

- 10AX 250V~, tip SF70
- sukladno normi EN 60669-1
- bezvijčani kontakti 1,5-2,5mm²

SWITCH INTERMEDIATE IP44 10AX 250V~

- 10AX 250V~, type SF70
- in accordance with EN 60669-1
- plug-in contacts 1.5-2.5mm²

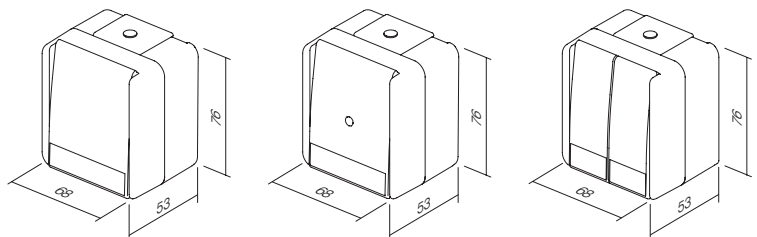

U T I Č N I C E V F S O C K E T S



VF10

PW

tip type	naziv description	tehnički podaci technical data	boja colour
VF10	ŠUKO UTIČNICA+POKLOPAC SOCKET SCHUKO+COVER	IP44 2P+E 16A 250V~	<input type="checkbox"/> PW bijela mat (RAL 9016) white-mat <input type="checkbox"/> GY mat siva grey-mat

UTIČNICA ŠUKO + POKLOPAC IP44 2P+E 16A 250V ~



- VF10PW
- VF10GY

- vijčano pričvršćivanje vodiča presjeka 1,5-2,5 mm²
- 2P+E šuko+poklopac
- 16A 250V~, tip VF10
- sukladno normama EN 60884-1, CEE7

SOCKET SCHUKO+COVER IP44 2P+E 16A 250V~

- screw contacts 1.5-2.5mm²
- 2P+E schuko+cover
- 16A 250V~, type VF10
- in accordance with EN 60884-1, CEE7



UTIČNICA ŠUKO + POKLOPAC IP44 2P+E 16A 250V ~ BV



- VF12PW
- VF12GY

- BV bezvijčani kontakti 1,5-2,5mm²
- 2P+E šuko+poklopac
- 16A 250V~, tip VF12
- sukladno normama EN 60884-1, CEE7

SOCKET SCHUKO+COVER IP44 2P+E 16A 250V~ BV

- BV plug-in contacts 1.5-2.5mm²
- 2P+E schuko+cover
- 16A 250V~, type VF12
- in accordance with EN 60884-1, CEE7

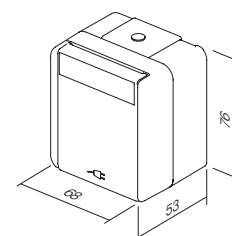

SF10
SF60

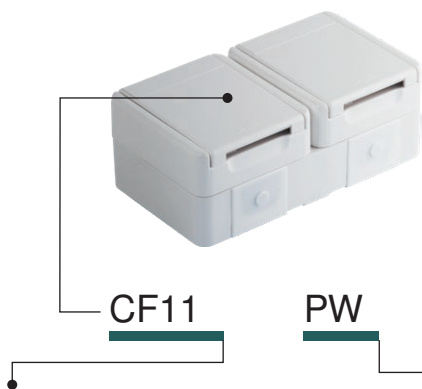

tip type	naziv description	tehnički podaci technical data	boja colour
CF10	SET ŠUKO UTIČNICA DVOSTRUKIH VODORAVNE SOCKET SET SCHUKO DOUBLE HORIZ	2x 2P+E 16A 250V~ IP44	<input type="checkbox"/> PW bijela mat (RAL 9016) white-mat
CF11	SET ŠUKO UTIČNICA DVOSTRUKIH OKOMITE SOCKET SET SCHUKO DOUBLE VERT	2x 2P+E 16A 250V~ IP44	<input checked="" type="checkbox"/> GY mat siva grey-mat
CF12	ŠUKO UTIČNICA + SKLOPKA IZMJENIČNI VODORAVNI SOCKET SCH+SWITCH 2WAY HORIZ	16A + 10A 250V~ IP44	
⋮	⋮	⋮	
⋮	⋮	⋮	



- CF10PW
 CF10GY

SET ŠUKO UTIČNICA, DVOSTRUKI, VODORAVNI IP44 2x 2P+E 16A 250V ~

- vijčano pričvršćivanje vodiča presjeka 1,5-2,5 mm²
- 2x 2P+E šuko + poklopac vodoravni
- 16A 250V~, tip CF10
- sukladno normama EN 60884-1, CEE7

SOCKET SET SCHUKO DOUBLE
HORIZONTAL IP44 2x 2P+E 16A 250V~
- screw contacts 1.5-2.5mm²
- 2x 2P+E schuko+cover horizontal
- 16A 250V~, type CF10
- in accordance with EN 60884-1, CEE7



- CF11PW
 CF11GY

SET ŠUKO UTIČNICA DVOSTRUKI, OKOMITI IP44 2x 2P+E 16A 250V ~

- vijčano pričvršćivanje vodiča presjeka 1,5-2,5 mm²
- 2x 2P+E šuko + poklopac, okomiti set
- 16A 250V~, tip CF11
- sukladno normama EN 60884-1, CEE7

SOCKET SET SCHUKO DOUBLE VERTICAL
IP44 2x 2P+E 16A 250V~
- screw contacts 1.5-2.5mm²
- 2x 2P+E schuko+cover vertical
- 16A 250V~, type CF11
- in accordance with EN 60884-1, CEE7



- CF12PW
 CF12GY

SET ŠUKO UTIČNICA + SKLOPKA IZMJENIČNA, VODORAVNI IP44 16A + 10AX 250V ~

- vijčano (priključnica), bezvijčano (sklopka) pričvršćivanje vodiča presjeka 1,5-2,5mm²
- 2P+E šuko+poklopac + sklopka izmjenična vodoravna
- 16A + 10AX 250V ~, tip CF12
- sukladno normama EN 60884-1, CEE7, EN 60669-1

SOCKET SCH+SWITCH SET 2WAY
HORIZONTAL IP44 16A + 10AX 250V~
- screw (socket), plug-in (switch)
contacts 1.5-2.5mm²
- 2P+E schuko+cover + switch 2-way horizontal
- 16A + 10AX 250V~, type CF12
- in accordance with EN 60884-1, CEE7, EN 60669-1



SET ŠUKO UTIČNICA + SKLOPKA IZMJENIČNA, OKOMITI, IP44 16A + 10AX 250V~



- CF13PW
- CF13GY

- vijčano (priključnica), bezvijčano (sklopka)
- pričvršćivanje vodiča presjeka 1,5-2,5mm²
- 2P+E šuko+poklopac + sklopka izmjenična okomita
- 16A + 10AX 250V ~, tip CF13
- sukladno normama EN 60884-1, CEE7, EN 60669-1

SOCKET SCH+SWITCH 2WAY SET VERTICAL IP44 16A + 10AX 250V~

- screw (socket), plug-in (switch)
- contacts 1.5-2.5mm²
- 2P+E schuko+cover + switch 2-way vertical
- 16A + 10AX 250V~, type CF13
- in accordance with EN 60884-1, CEE7, EN 60669-1



SET ŠUKO UTIČNICA DVOSTRUKI, VODORAVNI, IP44 2X 2P+E 16A 250V ~ BV



- CF14PW
- CF14GY

- BV bezvijčani kontakti 1,5-2,5mm²
- 2x 2P+E šuko + poklopac vodoravni
- 16A 250V~, tip CF14
- sukladno normama EN 60884-1, CEE7

SOCKET SET SCHUKO DOUBLE HORIZONTAL IP44 2x 2P+E 16A 250V~ BV

- BV plug-in contacts 1.5-2.5mm²
- 2x 2P+E schuko+cover horizontal
- 16A 250V~, type CF14
- in accordance with EN 60884-1, CEE7



SET ŠUKO UTIČNICA DVOSTRUKI, OKOMITI, IP44 2X 2P+E 16A 250V ~ BV



- CF15PW
- CF15GY

- BV bezvijčani kontakti 1,5-2,5mm²
- 2x 2P+E šuko + poklopac, okomiti set
- 16A 250V~, tip CF15
- sukladno normama EN 60884-1, CEE7

SOCKET SET SCHUKO DOUBLE VERTICAL IP44 2x 2P+E 16A 250V~ BV

- BV plug-in contacts 1.5-2.5mm²
- 2x 2P+E schuko+cover vertical
- 16A 250V~, type CF15
- in accordance with EN 60884-1, CEE7



SET UTIČNICA + SKLOPKA IZMJENIČNA, VODORAVNI, IP44 16A + 10AX 250V ~ BV



- CF16PW
- CF16GY

- BV bezvijčani kontakti 1,5-2,5mm²
- 2P+E šuko+poklopac + sklopka izmjenična vodoravna
- 16A + 10AX 250V ~, tip CF16
- sukladno normama EN 60884-1, CEE7, EN 60669-1

SOCKET+SWITCH SET SCH+2WAY HORIZONTAL IP44 16A + 10AX 250V~ BV

- BV plug-in contacts 1.5-2.5mm²
- 2P+E schuko+cover + switch 2-way horizontal
- 16A + 10AX 250V~, type CF16
- in accordance with EN 60884-1, CEE7, EN 60669-1



SET UTIČNICA + SKLOPKA IZMJENIČNA, OKOMITI, IP44 16A + 10AX 250V ~ BV



- CF17PW
- CF17GY

- BV bezvijčani kontakti 1,5-2,5mm²
- 2P+E šuko+poklopac + sklopka izmjenična okomita
- 16A + 10AX 250V ~, tip CF17
- sukladno normama EN 60884-1, CEE7, EN 60669-1

SOCKET SCH+SWITCH 2WAY SET VERTICAL IP44 16A + 10AX 250V~ BV

- BV plug-in contacts 1.5-2.5mm²
- 2P+E schuko+cover + switch 2-way vertical
- 16A + 10AX 250V~, type CF17
- in accordance with EN 60884-1, CEE7, EN 60669-1



PRIBOR A F ACCESSORIES



AF10

PW

tip type	naziv description	tehnički podaci technical data	boja colour
AF10	RAZDJELNI ORMARIĆ DISTRIBUTION BOX	IP44 RN01	<input type="checkbox"/> PW bijela mat (RAL 9016) white-mat
AF20	RAZDJELNI ORMARIĆ DISTRIBUTION BOX	IP55 NDO1	<input type="checkbox"/> GY mat siva grey-mat

RAZDJELNI ORMARIĆ IP44 RN01



- AF10PW
- AF10GY

- nadžbukni razdjelni ormarić IP44
- 16A 400V ~
- sukladno normi IEC/EN 60670-1, IEC/EN 60670-22

DISTRIBUTION BOX IP44 RN01

- surface mounting distribution box IP44
- 16A 400V ~
- in accordance with IEC/EN 60670-1, IEC/EN 60670-22

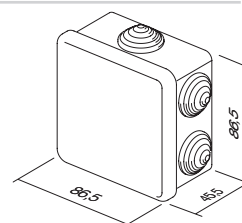

RAZDJELNI ORMARIĆ IP55 ND01



- AF20PW
- AF20GY

- nadžbukna priključna kutija IP55
- brtve uključene
- sukladno normi IEC/EN 60670-1, IEC/EN 60670-22

DISTRIBUTION BOX IP55 ND01

- surface mounting connection box IP55
- glands included
- in accordance with IEC/EN 60670-1, IEC/EN 60670-22

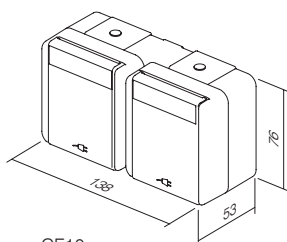
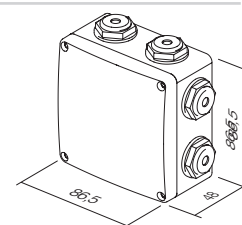
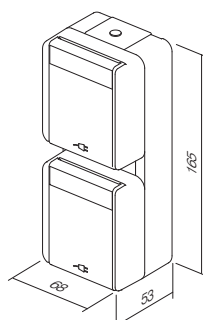
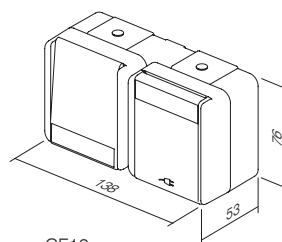
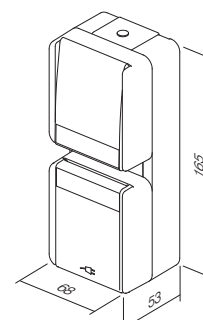
CF10
CF14CF11
CF15CF12
CF16CF13
CF17

MODUL

šifra	opis proizvoda	stranica	šifra	opis proizvoda	stranica
SKLOPKE SM			KOMUNIKACIJE KM		
SM10	SKLOPKA JEDNOPOLNA 16AX 250V- 1M	38	KM10--	UTIČNICA TV OSNOVNA 0dB 1M	52
SM11	TIPKALO JEDNOPOLNO 16A 250V- 1M	38	KM20--	UTIČNICA TV OSNOVNA 0dB 2M	52
SM12	SKLOPKA JEDNOPOLNA 20A 250V- 1M	38	KM11--	UTIČNICA TV ZAVRŠNA 1dB 1M	52
SM20	SKLOPKA DVOVOLNA 16AX 250V- 1M	38	KM12--	UTIČNICA TV PROLAZNA 10dB 1M	52
SM40	SKLOPKA ŽALUZIJSKA 1-0-2 16AX 250V- 1M	39	KM15--	UTIČNICA SAT OSNOVNA 0dB 1M	53
SM41	TIPKALO ŽALUZIJSKO 1-0-2 16A 250V- 1M	39	KM24--	UTIČNICA SAT OSNOVNA 0dB 2M	53
SM60	SKLOPKA IZMJENIČNA 16AX 250V- 1M	39	KM16--	UTIČNICA SAT ZAVRŠNA 1dB 1M	53
SM61	TIPKALO IZMJENIČNO 16A 250V- 1M	39	KM19--	UTIČNICA R OSNOVNA 0dB 1M	53
SM70	SKLOPKA KRIŽNA 16AX 250V- 1M	39	KM29--	UTIČNICA R OSNOVNA 0dB 2M	53
SM10--	SKLOPKA JEDNOPOLNA 16AX 250V- 1M	40	KM25--	UTIČNICA SAT-TV ZAVRŠNA 1dB 2M	53
SM10--IN	SKLOPKA JEDNOPOLNA 16AX 250V- 1M IN	40	KM22--	UTIČNICA AUDIO 2xRCA 1M	54
SM11--	TIPKALO JEDNOPOLNO 16A 250V- 1M	40	KM23--	UTIČNICA AUDIO ZVUČNICI 1M	54
SM11--IN01	TIPKALO JEDNOPOLNO 16A 250V- 1M IN 01	40	KM26--	UTIČNICA AUDIO ZVUČNICI 2M	54
SM11--IN02	TIPKALO JEDNOPOLNO 16A 250V- 1M IN 02	41	KM30--	UTIČNICA TEL LT RJ11 6/4 1M	55
SM20--NT03	SKLOPKA DVOVOLNA 16AX 250V- 1M NT 03	41	KM31--	UTIČNICA TEL BT SEC 6/6 1M	55
SM20--IN	SKLOPKA DVOVOLNA 16AX 250V- 1M IN	41	KM36--	UTIČNICA TEL KS RJ11 6/4 1M	55
SM40--NT10	SKLOPKA ŽALUZIJSKA 1-0-2 16AX 250V- 1M NT 10	41	KM37--	UTIČNICA CAT5e KS RJ45 8/8 1M	55
SM41--NT10	TIPKALO ŽALUZIJSKO 1-0-2 16A 250V- 1M NT 10	41	KM35--	ADAPTER KS 1M	55
SM60--	SKLOPKA IZMJENIČNA 16AX 250V- 1M	41	KM38--	ADAPTER KS SA ZAŠTITOM OD PRAŠINE 1M	55
SM61--	TIPKALO IZMJENIČNO 16A 250V- 1M	42	KM39--	UTIČNICA CAT6 SCH KS RJ45 8/8 1M	56
SM62--CD	TIPKALO IZMJENIČNO S UZICOM 16A 250V- 1M CD	42	KM50--	ADAPTER KS UNIVERZALNI 1M	56
SM70--	SKLOPKA KRIŽNA 16AX 250V- 1M	42	KM40--	ADAPTER PD 1M	56
TIPKE TM			KM43--	ADAPTER PD SA ZAŠTITOM OD PRAŠINE 1M	56
TM11--	TIPKA 1M	43	KM46--	ADAPTER R&M 1M	56
TM11--IN	TIPKA 1M INDIKATOR	43	KM52--	ADAPTER R&M CAT6A 1M	56
TM12--	TIPKA 2M	43	KM47--	ADAPTER R&M SA ZAŠTITOM OD PRAŠINE 1M	57
TM12--IN	TIPKA 2M INDIKATOR	43	KM53--	ADAPTER R&M CAT6A SA ZAŠTITOM OD PRAŠINE 1M	57
TM13--IL	TIPKA 2M S NATPISNOM PLOČICOM	44	KM45--	ADAPTER LK 1M	58
TM15--	TIPKA 1M DVOVOLNA	44	KA26	ADAPTER NEXSANS/SCHRACK 2M	58
TM21--	SLJEPI ELEMENT 1M	44	KM48--	ADAPTER AT&T SYSTIMAX SA ZAŠTITOM OD PRAŠINE 1M	58
TM22--	SLJEPI ELEMENT 2M	44	KM51--	UTIČNICA USB TIP A 1M	58
TM31--	UVODNICA 1M	44	DODACI KOMUNIKACIJA KA		
OSVETLJENJE IA			KA10	KONEKTOR KS CAT3 RJ11 6/4	59
IA10--	NEONSKA TINJALICA 230V- 0,34W	46	KA11	KONEKTOR KS CAT5e RJ45 8/8	59
IA20--	LED TINJALICA 230V- AC/DC 0,40W	46	KA12	KONEKTOR KS CAT5eS RJ45 8/8	59
IA21--	LED TINJALICA 24V AC/DC 0,20W	46	KA15	KONEKTOR KS CAT6 SCHRACK RJ45 8/8	59
IA22--	LED TINJALICA 12V AC/DC 0,10W	46	KA16	KONEKTOR KS CAT6S SCHRACK RJ45 8/8	59
IA50	RC SKLOP 250V	46	KA17	KONEKTOR KS CAT6a SCHRACK RJ45 8/8	59
UTIČNICE VM			KA18	KONEKTOR TANKI KS CAT6S SCHRACK RJ45 8/8	60
VM10--	UTIČNICA ŠUKO+KS 2P+E 16A 250V- 2M	48	KA27	KONEKTOR KS HDMI	60
VM11--	UTIČNICA ŠUKO+KS+POKLOPAC 2P+E 16A 250V- 2M	48	KA28	KABEL KS HDMI	60
VM20--	UTIČNICA EURO+KS 2P 10A 250V- 1M	49	ELEKTRONIKA EM		
VM40--	UTIČNICA FRANCUSKA+KS 2P+E 16A 250V- 2M	49	EM12--	REGULATOR OSVETLJENJA ROTACIJSKI IZMJENIČNI RL 300W 1M	61
VM41--	UTIČNICA FRANCUSKA+KS+POKLOPAC 2P+E 16A 250V- 2M	49	EM13--	REGULATOR OSVETLJENJA ROTACIJSKI IZMJENIČNI LED 60W 1M	61
VM30--	UTIČNICA TALJANSKA P17/11+KS 2P+E 16A 250V- 1M	49	EM14--	REGULATOR OSVETLJENJA ROTACIJSKI IZMJENIČNI LED 180W 1M	62
VM31--	UTIČNICA ŠUKO TALJANSKA P17/11+KS 2P+E 16A 250V- 2M	49	EM15--	REGULATOR OSVETLJENJA ROTACIJSKI R 250W 1M	62
VM32--	UTIČNICA ŠUKO TALJANSKA P30+KS 2P+E 16A 250V- 2M	50	EM16--		62
VM33--	UTIČNICA TALJANSKA P11+KS 2P+E 10A 250V- 1M	50	EM23	UGRADBENI ZATAMNJIVAČ R (250 W), (RC,RL 200VA)	63
VM21--	UTIČNICA EURO/AMERIČKA+KS 2P 16A 250V- 1M	50	EM18	UGRADBENI ZATAMNJIVAČ LED 250 W	63
VM52--	UTIČNICA BRITANSKA BS 1363+KS 2P+E 13A 250V- 2M	50	EM19	UGRADBENI ZATAMNJIVAČ DC LED 96 W	63
VM55--	UTIČNICA MULTISTANDARDNA+KS 2P+E 13A 250V- 2M	50	EM25--	SKLOPKA/REGULATOR OSVETLJENJA UNIVERZALNI RLC 0-300W 2M	65
VM80	PRENAPONSKA ZAŠTITA MPE MINI 275V/50Hz	50	EM26--	UPRAVLJAČKA JEDINICA - TIPKALO 2M	67
			EM27	FREKVENCIJSKI FILTAR	67
			EM25PPOL20	SET SKLOPKA/REGULATOR OSVETLJENJA UNIVERZALNI RLC 0-300W 2M PP OL20	67
			EM31--	IR SKLOPKA 5A 250V- 1M	68
			EM32--	IR SKLOPKA 5A 250V- 2M	68
			EM37--	TERMOSTAT OSNOVNI 6A 230V-2M	70
			EM38--	TERMOSTAT GRIJANJE 5(2) A 230 V- 2M	71
			EM39--	TERMOSTAT GRIJANJE/HLAĐENJE 3(1,5) A 230 V- 2M	71
			NM39	NOSAČ S VIJCIMA ZA TERMOSTATE FANTINI COSMI 3M	72
			EM40--	ŠTEDNA KARTIČNA SKLOPKA 3A 250V- 3M	72
			EM47	KARTICA ISO	72
			EM44--	ŠTEDNA KARTIČNA SKLOPKA RF HF 13,56MHz 3M	73
			EM49	ŠTEDNA KONTROLNA JEDINICA 2x16A 250V-	73
			EM45	RAZDCAJAČ SPL-1	73
			EM60--	UTIČNICA ZA BRIJAČI APARAT 230V~/120V- 3M	74
			EM67--	JEDINICA NAPAANJA 5V 2,4A 1M	74
			EM68--	USB PUNJAČ 5 V 3,0 A	75
			EM55	LED SVJETILJKA ZA SLUČAJ NUŽDE 250V- 0,9W, NiCd 3h 7M	75
			EM57	LED SVJETILJKA ZA SLUČAJ NUŽDE 230V- 50 Hz 0,5W, NiMH 2h 2M	75
			EM50--	LED SVJETILJKA JEDNOBOJNA 250V- 0,8W 2M	75
			EM51--	LED SVJETILJKA DVOBOJNA 250V- 2x0,4W 2M	76
			EM52--	LED SVJETILJKA 3D DVOBOJNA 250V- 2x0,4W 2M	76
			EM71--	PREKIDAČ NA OTISAK PRSTA BIOPASS 2M	77
			EM80--	SKLOPKA BESKONTAKTNA 10A 240V-	78
			EM81--	SKLOPKA BESKONTAKTNA, UPRAVLJAČKA JEDINICA	78
			EM91--	ZVONO 8VA 12V 1M	79
			EM93--	ZVONO 8VA 12V 1M	79
			EM94--	ZVONO 230V- 6mA rms 1M	79
			EM95--	REGULATOR GLASNOĆE ZA 100V AUDIO LINIJU 35W 2M	80
			EM96--	REGULATOR GLASNOĆE 4-8 Ω 35W 2M	80

šifra	opis proizvoda	stranica	šifra	opis proizvoda	stranica
SETOVI CM			KUTIJE OKRUGLE		
CM10--	SET UTIČNICA 2x ŠUKO 2P+E 16A 250V- 4M	81	DE10	KUTIJA OKRUGLA ZA ZID OD OPEKE SM60-01	110
CM11--	SET UTIČNICA 3x ŠUKO 2P+E 16A 250V- 7M	81	DE11	KUTIJA OKRUGLA ZA ZID OD OPEKE DUBOKA SM60-06	110
CM15	SET SPOJNIH VODOVA 3x1,5mm ² 1M	82	DE30	VEZNI ČLAN SM60-03	110
CM16	SET SPOJNIH VODOVA 3x2,5mm ² 2M	82	DE31	VEZNI ČLAN SM60-04	110
CM17	SET VIJAKA 3,5x20	82	DE12	KUTIJA OKRUGLA ZA ZID OD OPEKE MD65-46	111
CM18	SET VIJAKA 3,5x35	82	DE13	KUTIJA OKRUGLA ZA ZID OD OPEKE DUBOKA MD65-60	111
CM19	SET VIJAKA 3,5x50	82	DE14	PRODUŽETAK ZA MD65-46	111
CM22--	SET ZA SKLOPKE IP44 2M	82	DE32	VEZNI ČLAN MD65-71	111
CM23--	SET ZA UTIČNICU IP44 2M	82	DE33	VEZNI ČLAN MD65-91	111
CM25--OL	KUPAONSKI SET 3x20AX 250V- 4M	82	DE20	POKLOPAC KUTIJE ZAŠTITNI 60	111
CM25--OS	KUPAONSKI SET 3x20AX 250V- 4M	82	DE21	POKLOPAC KUTIJE ZAŠTITNI 65	111
NM41	NOSAČI ZA KUPAONSKI SET 4M	83	DE22	POKLOPAC KUTIJE DEKORATIVNI SM60	111
OL41--	OKVIR LINE ZA KUPAONSKI SET	83	HE10	KUTIJA OKRUGLA ZA ŠUPLJE ZIDOVE SM68x40	114
OS41--	OKVIR SOFT ZA KUPAONSKI SET	83	HE11	KUTIJA OKRUGLA ZA ŠUPLJE ZIDOVE SM68x55	114
ANTIBAKTERIJSKI PROGRAM AW			BE10	KUTIJA OKRUGLA ZA BETON 60-49	114
TM11AW	TIPKA 1M	85	BE11	KUTIJA OKRUGLA ZA BETON DUBOKA 60-77	114
TM11AWIN	TIPKA 1M INDIKATOR	85	BE20	NOSAČ KUTIJE ZA BETON	114
TM12AW	TIPKA 2M	85	BE21	UVODNICA ZA KUTIJO ZA BETON 16	114
TM12AWIN	TIPKA 2M INDIKATOR	85	PRAVOKUTNE KUTIJE		
TM21AW	SLIJEPI ELEMENT 1M	85	DM30	KUTIJA PRAVOKUTNA ZA ZID OD OPEKE PM3	118
TM22AW	SLIJEPI ELEMENT 2M	85	DM31	KUTIJA PRAVOKUTNA ZA ZID OD OPEKE PM3-65	118
VM10AW	UTIČNICA ŠUKO+KS 2P+E 16A 250V- 2M	86	DM40	KUTIJA PRAVOKUTNA ZA ZID OD OPEKE PM4	118
VM11AW	VTIČNICA ŠUKO+KS+POKLOPAC 2P+E 16A 250V- 2M	86	DM41	KUTIJA PRAVOKUTNA ZA ZID OD OPEKE PM4-65	118
VM20AW	UTIČNICA EURO+KS 2P 10A 250V- 1M	86	DM70	KUTIJA PRAVOKUTNA ZA ZID OD OPEKE PM7	119
KM11AW	UTIČNICA TV ZAVRŠNA 1dB 1M	86	DM71	KUTIJA PRAVOKUTNA ZA ZID OD OPEKE PM7-65	119
KM35AW	ADAPTER KS 1M	86	DM72	KUTIJA PRAVOKUTNA ZA ZID OD OPEKE PM72-65	119
OS20AW	OKVIR SOFT 2M	87	DM80	VEZNI ČLAN KUTIJE PM	119
OS24AW	OKVIR SOFT 2x2M	87	DM33	POKLOPAC KUTIJE ZAŠTITNI PM3	120
OS26AW	OKVIR SOFT 3x2M	87	DM34	POKLOPAC KUTIJE DEKORATIVNI PM3	120
OS30AW	OKVIR SOFT 3M	87	DM43	POKLOPAC KUTIJE ZAŠTITNI PM4	120
OS40AW	OKVIR SOFT 4M	87	DM44	POKLOPAC KUTIJE DEKORATIVNI PM4	120
OS70AW	OKVIR SOFT 7M	87	DM73	POKLOPAC KUTIJE ZAŠTITNI PM7	120
OKVIRI PURE OP			DM74	POKLOPAC KUTIJE DEKORATIVNI PM7	120
OP20--	OKVIR PURE 2M	90	DM75	POKLOPAC KUTIJE DEKORATIVNI PM72	121
OP24--	OKVIR PURE 2x2M	90	HM30	KUTIJA PRAVOKUTNA ZA ŠUPLJE ZIDOVE VM3	122
OP26--	OKVIR PURE 3x2M	90	HM40	KUTIJA PRAVOKUTNA ZA ŠUPLJE ZIDOVE VM4	122
OP28--	OKVIR PURE 4x2M	90	HM70	KUTIJA PRAVOKUTNA ZA ŠUPLJE ZIDOVE VM7	122
OP30--	OKVIR PURE 3M	91	HM72	KUTIJA PRAVOKUTNA ZA ŠUPLJE ZIDOVE VM72	122
OP40--	OKVIR PURE 4M	91	BM30	PRAVOKUTNA KUTIJA ZA BETON BM3	123
OP70--	OKVIR PURE 7M	91	BM40	PRAVOKUTNA KUTIJA ZA BETON BM4	123
OP13--	OKVIR PURE 1/3M	91	BM70	PRAVOKUTNA KUTIJA ZA BETON BM7	123
OP23--	OKVIR PURE 2/3M	91	BM80	PRIČVRSNI KOMBI-DRŽAČ BM	123
OKVIRI LINE OL			BM82	VEZNI PROFIL ZA KUTIJE	123
OL20--	OKVIR LINE 2M	94	PRIKLJUČNE KUTIJE		
OL24--	OKVIR LINE 2x2M	94	DW10	KUTIJA PRIKLJUČNA OKRUGLA ZA ZID OD OPEKE DSM78	126
OL26--	OKVIR LINE 3x2M	94	HW10	KUTIJA PRIKLJUČNA OKRUGLA ZA ŠUPLJE ZIDOVE SM78x45	126
OL28--	OKVIR LINE 4x2M	94	DE23	POKLOPAC KUTIJE DEKORATIVNI SM78	126
OL29--	OKVIR LINE 5x2M	94	DE24	POKLOPAC KUTIJE ZAŠTITNI 78	126
OL30--	OKVIR LINE 3M	95	HW20	KUTIJA PRIKLJUČNA ČETVRTASTA ZA ZID OD OPEKE SM105x105	126
OL40--	OKVIR LINE 4M	95	PRIBOR ZA OŽIČENJE		
OL70--	OKVIR LINE 7M	95	UW10--	JEDNOREDNE STEZALJKE ZATVORENE PC 2x2,5mm ² 10P	128
OL10--	OKVIR LINE 1/2M	95	UW11--	JEDNOREDNE STEZALJKE ZATVORENE PC 2x4,0mm ² 10P	128
OL13--	OKVIR LINE 1/3M	95	UW12--	JEDNOREDNE STEZALJKE ZATVORENE PC 2x6,0mm ² 10P	128
OL23--	OKVIR LINE 2/3M	95	UW15--	JEDNOREDNE STEZALJKE PA 2x2,5mm ² 12P	128
OKVIRI SOFT OS			UW16--	JEDNOREDNE STEZALJKE PA 2x4mm ² 12P	128
OS20--	OKVIR SOFT 2M	98	UW17--	JEDNOREDNE STEZALJKE PA 2x6mm ² 12P	128
OS24--	OKVIR SOFT 2x2M	98	UW29--	DVOREDNE STEZALJKE PP 1,0-4,0mm ² 12P	128
OS26--	OKVIR SOFT 3x2M	98	UW30--	DVOREDNE STEZALJKE PP 1,5-6,0mm ² 12P	128
OS28--	OKVIR SOFT 4x2M	98	UW31--	DVOREDNE STEZALJKE PP 2,5-10,0mm ² 12P	128
OS30--	OKVIR SOFT 3M	99	UW32--	DVOREDNE STEZALJKE PP 4,0-16,0mm ² 12P	128
OS40--	OKVIR SOFT 4M	99	UW25--	DVOREDNE STEZALJKE PA 1,0-4,0mm ² 12P	129
OS70--	OKVIR SOFT 7M	99	UW26--	DVOREDNE STEZALJKE PA 1,5-6,0mm ² 12P	129
OS72--	OKVIR SOFT 2x7M	99	UW27--	DVOREDNE STEZALJKE PA 2,5-10,0mm ² 12P	129
OS10--	OKVIR SOFT 1/2M	99	UW28--	DVOREDNE STEZALJKE PA 4,0-16,0mm ² 12P	129
OS13--	OKVIR SOFT 1/3M	99	UW40--	BEZVIJČANE REDNE STEZALJKE PA 1,5mm ² 3P	129
OS23--	OKVIR SOFT 2/3M	99	UW41--	BEZVIJČANE REDNE STEZALJKE PA 1,5mm ² 5P	129
NOSAČI MM			UW42--	BEZVIJČANE REDNE STEZALJKE PA 1,5mm ² 8P	129
NM20	NOSAČ S NOŽICAMA 2M	104	UW45--	BEZVIJČANE REDNE STEZALJKE PA 2,5mm ² 3P	129
NM21	NOSAČ BEZ VIJAKA 2M	104	UW46--	BEZVIJČANE REDNE STEZALJKE PA 2,5mm ² 4P	129
NM24	NOSAČ METALNI S NOŽICAMA 2M	104	UW47--	BEZVIJČANE REDNE STEZALJKE PA 2,5mm ² 5P	129
NM25	NOSAČ METALNI BEZ VIJAKA 2M	104	UW50--	BEZVIJČANE REDNE STEZALJKE PA 2,5mm ² 2/1P	129
NM30	NOSAČ S VIJCIMA 3M	105			
NM40	NOSAČ S VIJCIMA 4M	105			
NM70	NOSAČ S VIJCIMA 7M	105			
NM72	NOSAČ S VIJCIMA 2x7M	105			
NM10	NOSAČ S NOŽICAMA 1/2M	106			
NM11	NOSAČ BEZ VIJAKA 1/2M	106			
NM23	NOSAČ S NOŽICAMA 2/3M	106			
NM32	NOSAČ S VIJCIMA 2/3M	106			

distribucija —

LOGIQ —

šifra	opis proizvoda	stranica
KUĆIŠTA CUBO IP20 AC		
AC11--	KUTIJA NO CUBO SA STRAŽNJIM POKLOPCEM IP20 1M	132
AC21--	KUTIJA NO CUBO SA STRAŽNJIM POKLOPCEM IP20 2M	132
AC41--	KUTIJA NO CUBO SA STRAŽNJIM POKLOPCEM IP20 4M	132
AC61--	KUTIJA NO CUBO SA STRAŽNJIM POKLOPCEM IP20 6M	132
KUĆIŠTA CUBO IP55 AQ		
AQ20--	KUĆIŠTE NO CUBO IP55 2M	133
AQ22--	KUĆIŠTE NO CUBO IP55 2x2M	133
AQ30--	KUĆIŠTE NO CUBO IP55 3M	133
AQ21--	KUTIJA PO CUBO IP55 2M	134
AQ31--	KUĆIŠTE PO CUBO IP55 3M	134
PARAPETNI KANALI ALUMINIJSKI MA		
RT10	ADAPTER MA 92	135
RT12--	POKLOPAC MA 92 2/3M	135
RT14--	POKLOPAC MA 92 4M	135
RT17--	POKLOPAC MA 92 7M	135
RT20--	OSNOVA KANALA MA 130x65	136
RT21--	OSNOVA KANALA MA 165x65	136
RT25--	POKLOPAC KANALA MA 92	136
RT30	PREGRAĐA MA 43	136
RT31	PREGRAĐA MA 43 AL	136
RT32	PREGRAĐA MA 43 AL DVOSTRUKA	136
RT35--	ZAVRŠNI ELEMENT MA 130x65	137
RT36--	ZAVRŠNI ELEMENT MA 165x65	137
RT38	RAVNI VEZNI ELEMENT MA 65	137
RT40--	UNIVERZALNI KUT MA 130x65	137
RT41--	UNIVERZALNI KUT MA 165x65	137
RT42	ELEMENT ZA UZEMLJENJE MA 2x A6,3	137
RT43--	L-KOMAD ELEMENT MA 130x65	138
RT44--	L-KOMAD ELEMENT MA 165x65	138
RT45--	T-KOMAD MA 130x65	138
RT46--	T-KOMAD MA 165x65	138
RT50--	NOSAČ STUPIČA MA JEDNOSTRUKI 130x65	139
RT51--	NOSAČ STUPIČA MA DVOSTRUKI 130x65	139
RT52--	STUPIČ MA 130x65x500	139
RT53--	STUPIČ MA DVOSTRUKI 130x130x500	139
PODNE KUTIJE MT		
RB50	UGRADNO KUĆIŠTE PODNE KUTIJE 4M	141
RB60	UMETAK PODNE KUTIJE 4M	141
RB65S1	POKLOPAC PODNE KUTIJE 4M	141
RB51	UGRADNO KUĆIŠTE PODNE KUTIJE 7M	141
RB61	UMETAK PODNE KUTIJE 7M	141
RB66S1	POKLOPAC PODNE KUTIJE 7M	141
RB52	UGRADNO KUĆIŠTE PODNE KUTIJE 2X7M	142
RB62	UMETAK PODNE KUTIJE 2X7M	142
RB67S2	POKLOPAC PODNE KUTIJE 2X7M	142
RB53	UGRADNO KUĆIŠTE PODNE KUTIJE 4X7M	142
RB62	UMETAK PODNE KUTIJE 2X7M	142
RB68S2	POKLOPAC PODNE KUTIJE 4X7M	142
RB55S1	PODNA KUTIJA ZA DVOSTRUKE PODOVE S POKLOPCEM 4M	143
RB60	UMETAK PODNE KUTIJE 4M	143
RB56S1	PODNA KUTIJA ZA DVOSTRUKE PODOVE S POKLOPCEM 7M	144
RB61	UMETAK PODNE KUTIJE 7M	144
RB57S2	PODNA KUTIJA ZA DVOSTRUKE PODOVE S POKLOPCEM 2X7M	144
RB62	UMETAK PODNE KUTIJE 2X7M	144
RB58S2	PODNA KUTIJA ZA DVOSTRUKE PODOVE S POKLOPCEM 4X7M	144
RB62	UMETAK PODNE KUTIJE 2X7M	144
RB10	ADAPTER ZA DIN-TRAČNICU 35mm 1M	145
RB11	ADAPTER ZA DIN-TRAČNICU 35mm 2M	145

šifra	opis proizvoda	stranica
PREKIDAČI SQ		
SQ10--XO	SKLOPKA JEDNOPOLNA 10AX 250V-	158
SQ10--INXO	SKLOPKA JEDNOPOLNA 10AX 250V- __ IN	158
SQ11--XO	TIPKALO JEDNOPOLNO 10A 250V-	158
SQ11--IN01XO	TIPKALO JEDNOPOLNO 10A 250V- __ IN 01	158
SQ11--IN02XO	TIPKALO JEDNOPOLNO 10A 250V- __ IN 02	159
SQ22--IN03XO	SKLOPKA DVOPOLNA 16AX 250V- __ IN 03	159
SQ50--XO	SKLOPKA SERIJSKA 10AX 250V-	159
SQ51--XO	TIPKALO SERIJSKO 10A 250V-	159
SQ52--NT09XO	SKLOPKA ŽALUZIJSKA 10AX 250V- __ NT 09	159
SQ53--NT09XO	TIPKALO ŽALUZIJSKO 10A 250V- __ NT 09	159
SQ60--XO	SKLOPKA IZMJENIČNA 10AX 250V-	159
SQ63--XO	SKLOPKA IZMJENIČNA DVOSTRUKA 10AX 250V-	160
SQ70--XO	SKLOPKA KRIŽNA 10AX 250V-	160
INDIKACIJA IA		
IA10--	NEONSKA TINJALICA 230V~ 0,34W	161
IA20--	LED TINJALICA 230V~ AC/DC 0,40W	161
IA21--	LED TINJALICA 24V AC/DC 0,20W	161
IA22--	LED TINJALICA 12V AC/DC 0,10W	161
UTIČNICE VQ		
VQ10--XO	UTIČNICA ŠUKO 2P+E 16A 250V- __ XO	164
VQ11--XO	UTIČNICA ŠUKO+POKLOPAC 2P+E 16A 250V- __ XO	164
VQ12--XO	UTIČNICA ŠUKO 2P+E 16A 250V- BV __ XO	164
VQ13--XO	UTIČNICA ŠUKO+POKLOPAC 2P+E 16A 250V- BV __ XO	164
VQ16--	UTIČNICA ŠUKO DVOSTRUKA 2P+E 16A 250V-	164
KOMUNIKACIJE KQ		
KQ10--XO	UTIČNICA TV OSNOVNA 0dB	165
KQ11--XO	UTIČNICA TV-R ZAVRŠNA 1dB	165
KQ12--XO	UTIČNICA TV-R PROLAZNA 10dB	165
KQ16--XO	UTIČNICA SAT-TV-R ZAVRŠNA 3dB	165
KQ22--XO	UTIČNICA AUDIO 2xRCA	166
KQ23--XO	UTIČNICA AUDIO ZA ZVUČNIKE	166
KQ36--XO	UTIČNICA TEL KS RJ11 6/4	166
KQ37--XO	UTIČNICA CAT5e KS RJ45 8/8	166
KQ38--XO	UTIČNICA TEL KS DVOSTRUKA 2x RJ11 6/4	166
KQ39--XO	UTIČNICA CAT5e KS DVOSTRUKA 2x RJ45 8/8	166
KQ35--XO	UTIČNICA TEL LT RJ11 6/4	166
KQ40--XO	UTIČNICA CAT6s KS DVOSTRUKA 2x RJ45 8/8 SLIM	167
KQ41--XO	UTIČNICA CAT6s KS DVOSTRUKA 2x RJ45 8/8 SLIM	167
ELEKTRONIKA EQ		
EQ15--XO	ZATAMNJIVAČ ROTACIJSKI IZMJEN RL 400W	168
EQ16--XO	ZATAMNJIVAČ ROTACIJSKI IZMJEN RLC 400W	168
EQ19--XO	ZATAMNJIVAČ ROTACIJSKI IZMJEN LED 100W	168
EQ32--XO	IR SKLOPKA 5A 230V-	170
EQ35--XO	TERMOSTAT GRIJANJE 10A 230V-	170
EQ36--XO	TERMOSTAT GRIJANJE / HLAĐENJE 5A 230V-	170
EQ37--XO	TERMOSTAT PODNO GRIJANJE 16A 230V-	171
EQ68--	USB PUNJAČ 5 V 3,0 A	171
PRIBOR PQ		
PQ10--XO	PUNILO	172
PQ30--	POKLOPAC TAE/TDO	172
OKVIRI OQ		
OQ10--	OKVIR LOGIQ 1	173
OQ20--	OKVIR LOGIQ 2	173
OQ30--	OKVIR LOGIQ 3	174
OQ40--	OKVIR LOGIQ 4	174
OQ50--	OKVIR LOGIQ 5	174

ekonomik

šifra	opis proizvoda	stranica
PREKIDAČI SE		
SE10	SKLOPKA JEDNOPOLNA 10AX 250V-	186
SE11	TIPKALO JEDNOPOLNO 10A 250V-	186
SE22	SKLOPKA DVOPOLNA 16AX 250V-	186
SE50	SKLOPKA SERIJSKA JEDNOPOLNA 10AX 250V-	186
SE51	TIPKALO SERIJSKO JEDNOPOLNO 10A 250V-	187
SE52	SKLOPKA ŽALUZIJSKA 10AX 250V-	187
SE53	TIPKALO ŽALUZIJSKO 10A 250V-	187
SE60	SKLOPKA IZMJENIČNA 10AX 250V-	187
SE63	SKLOPKA IZMJENIČNA DVOSTRUKA 10AX 250V-	187
SE70	SKLOPKA KRIŽNA 10AX 250V-	187
SE10--	SKLOPKA JEDNOPOLNA 10AX 250V-	188
SE10--IN	SKLOPKA JEDNOPOLNA 10AX 250V- IN	188
SE11--	TIPKALO JEDNOPOLNO 10A 250V-	188
SE11--TI50	TIPKALO JEDNOPOLNO 10A 250V- TI 50	188
SE11--TI51	TIPKALO JEDNOPOLNO 10A 250V- TI 51	188
SE11--IL	TIPKALO JEDNOPOLNO 10A 250V- IL	188
SE22--IN03	SKLOPKA DVOPOLNA 10AX 250V- IN 03	188
SE50--	SKLOPKA SERIJSKA JEDNOPOLNA 10AX 250V-	189
SE51--	TIPKALO SERIJSKO JEDNOPOLNO 10A 250V-	189
SE52--NT09	SKLOPKA ŽALUZIJSKA 10AX 250V- NT 09	189
SE53--NT09	TIPKALO ŽALUZIJSKO 10A 250V- NT 09	189
SE60--	SKLOPKA IZMJENIČNA 10AX 250V-	189
SE63--	SKLOPKA IZMJENIČNA DVOSTRUKA 10AX 250V-	189
SE70--	SKLOPKA KRIŽNA 10AX 250V-	189
TIPKE TE		
TE10--	TIPKA OBIČNA	190
TE10--IN	TIPKA INDIKATOR	190
TE13--IL	TIPKA S NATPISNOM PLOČICOM	190
TE11--	TIPKA SERIJSKA	190
INDIKACIJA IA		
IA10--	NEONSKA TINJALICA 230V- 0,34W	191
IA20--	LED TINJALICA 230V- AC/DC 0,40W	191
IA21--	LED TINJALICA 24V AC/DC 0,20W	191
IA22--	LED TINJALICA 12V AC/DC 0,10W	191
UTIČNICE VE		
VE10--XO	UTIČNICA ŠUKO 2P+E 16A 250V- XO	194
VE11--XO	UTIČNICA ŠUKO+POKLOPAC 2P+E 16A 250V- XO	194
VE12--XO	UTIČNICA ŠUKO 2P+E 16A 250V- BV XO	194
VE13--XO	UTIČNICA ŠUKO+POKLOPAC 2P+E 16A 250V- BV XO	194
VE10--	UTIČNICA ŠUKO 2P+E 16A 250V-	194
VE11--	UTIČNICA ŠUKO+POKLOPAC 2P+E 16A 250V-	194
VE12--	UTIČNICA ŠUKO 2P+E 16A 250V- BV	194
VE13--	UTIČNICA ŠUKO+POKLOPAC 2P+E 16A 250V- BV	194
VE40--XO	UTIČNICA FRANCUSKA 2P+E 16A 250V- XO	195
VE41--XO	UTIČNICA FRANCUSKA+POKLOPAC 2P+E 16A 250V- XO	195
VE42--XO	UTIČNICA FRANCUSKA 2P+E 16A 250V- BV XO	195
VE43--XO	UTIČNICA FRANCUSKA+POKLOPAC 2P+E 16A 250V- BV XO	195
VE40--	UTIČNICA FRANCUSKA 2P+E 16A 250V-	195
VE41--	UTIČNICA FRANCUSKA+POKLOPAC 2P+E 16A 250V-	195
VE42--	UTIČNICA FRANCUSKA 2P+E 16A 250V- BV	195
VE43--	UTIČNICA FRANCUSKA+POKLOPAC 2P+E 16A 250V- BV	195
VE16--	UTIČNICA ŠUKO DVOSTRUKA 2P+E 16A 250V-	196
VE46--	UTIČNICA FRANCUSKA DVOSTRUKA 2P+E 16A 250V-	196
VE30--	UTIČNICA 2P 16A 250V-	196
KOMUNIKACIJE KE		
KE11	UTIČNICA TV-R ZAVRŠNA 1dB	197
KE12	UTIČNICA TV-R PROLAZNA 10dB	197
KE16	UTIČNICA SAT-TV-R ZAVRŠNA 3dB	197
KE36	UTIČNICA TEL KS RJ11 6/4	197
KE37	UTIČNICA CAT5e KS RJ45 8/8	198
KE40	UTIČNICA CAT6s KS RJ45 8/8 SLIM	198
KE38	UTIČNICA TEL KS DVOSTRUKA 2x RJ11 6/4	198
KE39	UTIČNICA CAT5e KS DVOSTRUKA 2x RJ45 8/8	198
KE41	UTIČNICA CAT6s KS DVOSTRUKA 2x RJ45 8/8 SLIM	198
KE45	ADAPTER KS JEDNOSTRUKI	198
KE46	ADAPTER KS DVOSTRUKI	199
KE47	ADAPTER PD DVOSTRUKI	199
KE10--	UTIČNICA TV OSNOVNA 0dB	200
KE11--	UTIČNICA TV-R ZAVRŠNA 1dB	200
KE12--	UTIČNICA TV-R PROLAZNA 10dB	200
KE16--	UTIČNICA SAT-TV-R ZAVRŠNA 3dB	200
KE22--	UTIČNICA AUDIO 2xRČA	200
KE23--	UTIČNICA AUDIO ZVUČNICI	200
KE36--	UTIČNICA TEL KS RJ11 6/4	200
KE37--	UTIČNICA CAT5e KS RJ45 8/8	201
KE40--	UTIČNICA CAT6s KS RJ45 8/8 SLIM	201
KE38--	UTIČNICA TEL KS DVOSTRUKA 2x RJ11 6/4	201
KE39--	UTIČNICA CAT5e KS DVOSTRUKA 2x RJ45 8/8	201
KE41--	UTIČNICA CAT6s KS DVOSTRUKA 2x RJ45 8/8 SLIM	201
KE35--	UTIČNICA TEL LT RJ11 6/4	201

šifra	opis proizvoda	stranica
POKLOPCI ZA KOMUNIKACIJE PE		
PE10--	POKLOPAC TV-R 2P/3P	202
PE20--	POKLOPAC KS JEDNOSTRUKI	202
PE21--	POKLOPAC KS DVOSTRUKI	202
PE30--	POKLOPAC TAE/TDO	202

šifra	opis proizvoda	stranica
ELEKTRONIKA EE		
EE15	REGULATOR OSVJETLJENJA ROTACIJSKI IZMJENIČNI RL 400W	203
EE16	REGULATOR OSVJETLJENJA ROTACIJSKI IZMJENIČNI RLC 400W	203
EE19	REGULATOR OSVJETLJENJA ROTACIJSKI IZMJENIČNI LED 100W	204
EE32	IR SKLOPKA 5A 230V-	204
EE67	USB PUNJAČ 5 V 2,4 A	204
EE15--	REGULATOR OSVJETLJENJA ROTACIJSKI IZMJENIČNI RL 400W	205
EE16--	REGULATOR OSVJETLJENJA ROTACIJSKI IZMJENIČNI RLC 400W	205
EE19--	REGULATOR OSVJETLJENJA ROTACIJSKI IZMJENIČNI LED 100W	205
EE32--	IR SKLOPKA 5A 230V-	205
EE67--	USB PUNJAČ 5 V 2,4 A	206

šifra	opis proizvoda	stranica
POKLOPCI ELEKTRONIKE PE		
PE41--	POKLOPAC REGULATOR OSVJETLJENJA Ø6	208
PE32--	POKLOPAC IR SKLOPKA	208
PE67--	POKLOPAC USB PUNJAČA	208

šifra	opis proizvoda	stranica
PRIBOR AE		
AE10--	SLIJEPI ELEMENT	209
AE20--	PRIKLJUČNA KUTIJA 5-POLNA 3P+N+E 5x4mm ²	209
AE30--	NADŽBUKNA KUTIJA 1	209
AE31--	NADŽBUKNA KUTIJA ZA DVOSTRUKU UTIČNICU EKONOMIK	209
AE50--	ZIDNI ŠTITNIK	210
AE51--	ZAŠTITA ZA DJECU KS	210

šifra	opis proizvoda	stranica
OKVIRI OE		
OE10--	OKVIR EKONOMIK 1	211
OE20--	OKVIR EKONOMIK 2 VODORAVNI	211
OE21--	OKVIR EKONOMIK 2 OKOMITI	211
OE30--	OKVIR EKONOMIK 3 VODORAVNI	211
OE31--	OKVIR EKONOMIK 3 OKOMITI	212
OE40--	OKVIR EKONOMIK 4 VODORAVNI	212
OE41--	OKVIR EKONOMIK 4 OKOMITI	212
OE50--	OKVIR EKONOMIK 5 VODORAVNI	212
OE90--	DEKORATIVNI UMETCI U BOJI	213

fontana

šifra	opis proizvoda	stranica
SKLOPKE SF		
SF10--	SKLOPKA JEDNOPOLNA IP44 10AX 250V-	216
SF10--TI	SKLOPKA JEDNOPOLNA IP44 10AX 250V- TI	216
SF11--TI	TIPKALO JEDNOPOLNO IP44 10A 250V- TI	216
SF20--	SKLOPKA DVOPOLNA IP44 10AX 250V-	216
SF50--	SKLOPKA SERIJSKA IP44 10AX 250V-	217
SF51--	TIPKALO SERIJSKO IP44 10A 250V-	217
SF60--	SKLOPKA IZMJENIČNA IP44 10AX 250V-	217
SF60--TI	SKLOPKA IZMJENIČNA IP44 10AX 250V- TI	217
SF63--	SKLOPKA IZMJENIČNA DVOSTRUKA IP44 10AX 250V-	217
SF70--	SKLOPKA KRIŽNA IP44 10AX 250V-	217
UTIČNICE VF		
VF10--	UTIČNICA ŠUKO+POKLOPAC IP44 2P+E 16A 250V-	218
VF12--	UTIČNICA ŠUKO+POKLOPAC IP44 2P+E 16A 250V- BV	218
SETOVI CF		
CF10--	SET ŠUKO UTIČNICA DVOSTRUKI VODORAVNI IP44 2x2P+E 16A 250V-	219
CF11--	SET ŠUKO UTIČNICA DVOSTRUKI OKOMITI IP44 2x2P+E 16A 250V-	219
CF12--	SET ŠUKO UTIČNICA + SKLOPKA IZMJENIČNA VODORAVNI IP44 16A + 10AX 250V-	219
CF13--	SET ŠUKO UTIČNICA + SKLOPKA IZMJENIČNA OKOMITI IP44 16A + 10AX 250V-	220
CF14--	SET ŠUKO UTIČNICA DVOSTRUKI VODORAVNI IP44 2x 2P+E 16A 250V-BV	220
CF15--	SET ŠUKO UTIČNICA DVOSTRUKI OKOMITI IP44 2x 2P+E 16A 250V- BV	220
CF16--	SET UTIČNICA + SKLOPKA IZMJENIČNA VODORAVNI IP44 16A + 10AX 250V- BV	220
CF17--	SET UTIČNICA SKLOPKA IZMJENIČNA OKOMITI IP44 16A + 10AX 250V- BV	220

šifra	opis proizvoda	stranica
PRIBOR AF		
AF10--	RAZDJELNI ORMARIĆ IP44 RN01	221
AF20--	RAZDJELNI ORMARIĆ IP55 ND01	221



TEM

On | Off and everything in between

100% ELEKTRISCH

www.tem.si

TEM

On|Off and everything in between



www



TEM

TEM ČATEŽ d.o.o.
Čatež 13, 8212 VELIKA LOKA
SLOVENIJA
tem@tem.si
www.tem.si

T +386(0)7 348 99 00

TEM

JVE

www.tem.si

