

TEM 2020

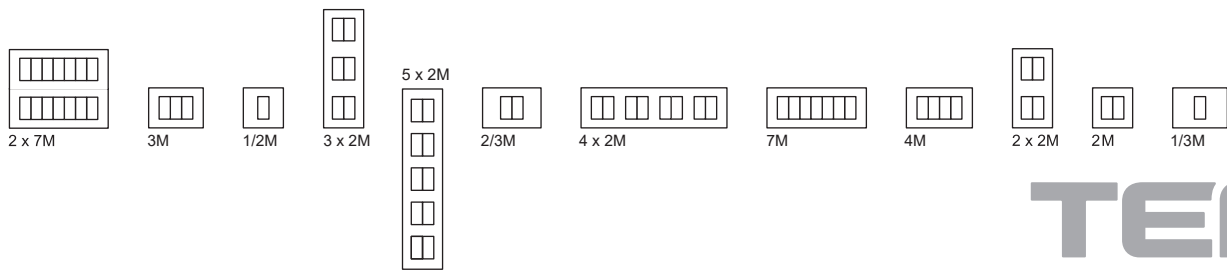

On | Off and everything in between





TEM

Dobrodošli u obitelj MODUL

Welcome to the MODUL family

Proširujemo i usavršavamo modernu obitelj Modul sklopki za sve vrste prostorija.

We are expanding and perfecting the modern Modul switch family for all types of rooms.



discovering new insights

otkrivanje novih saznanja

MODUL

Dizajnerske linije Pure, Line i Soft odražavaju moderan, sofisticiran i neovisan životni stil. U širokoj paleti boja, uzoraka i oblika možete odabrati sklopke i utičnice koje će pristajati željenoj atmosferi i ugodaju.

The Pure, Line and Soft design lines reflect a modern, sophisticated and independent lifestyle. You can choose from a wide and rich selection of colours, patterns and shapes to alter the appearance of your switches and sockets so that they fit the desired atmosphere and mood.

PURE

prirodni materijali

drvo
metal
staklo

wood
metal
glass

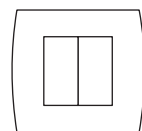

—line—

—soft—



ravne linije



meke linije

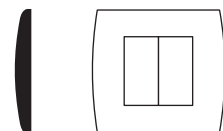
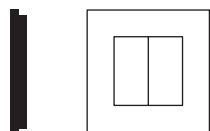

PURE



predivan život wonderful living

Iz čistoće i neokaljanosti novonastalog svijeta dolazi priča linije Pure. Dodir prirodnih motiva prošaran je sofisticiranim ukusom za linije i oblik i isprepleten nitima najnovije tehnologije.

From the cleanliness and purity of a new-born world stems the story of the Pure line. The touch of natural motifs is intertwined with a sophisticated taste for lines and form and interwoven with threads of state-of-the-art technology.



PURE

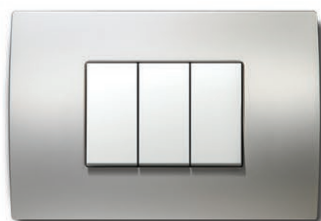



osjetiti prirodu feeling of nature

Linija Pure sklopki ističe se svojim prirodnim materijalima: metalom, drvom i staklom. Njezin jedinstveni dizajn ima posebnu draž. Upečatljiv, no ipak nenametljiv. Zrači senzualnošću, sofisticiranošću, visokim standardima te, naravno, čistoćom.

The Pure switch line is distinguished by its natural materials: metal, wood and glass. Its unique design gives it a special touch. It is striking yet unobtrusive. It radiates sensuality, sophistication, high standards and, of course, cleanliness.

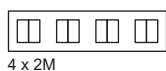

4 x 2M



3M



3 x 2M



2/3M



7M



4M



2 x 2M



2M



1/3M

line



harmonija ravnih linija

harmony of straight lines

Pripremite se za elegantno savršenstvo ravnih oblika. Isprobajte sjajne površine koje se poigravaju s modernim elementima vaše sobe. Samo za vas smo uključili smo „Soft Touch”, pretvarajući svaki dodir u jedinstveno iskustvo.

Prepare for the elegant perfection of straight shapes. Try brilliant surfaces that gently play with modern elements of your room. We have incorporated “Soft Touch” technology especially for you, turning every touch into a unique experience.



line

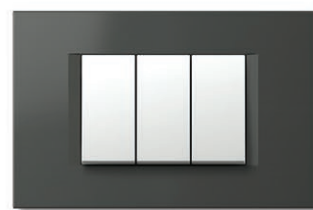
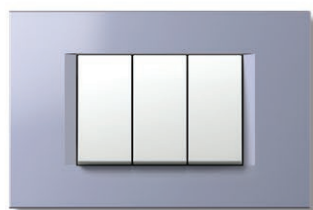
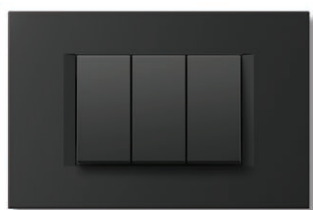
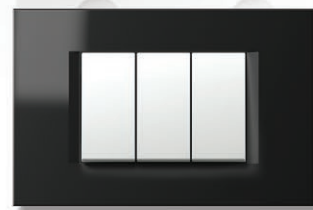
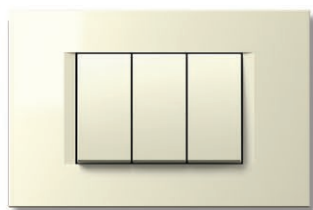
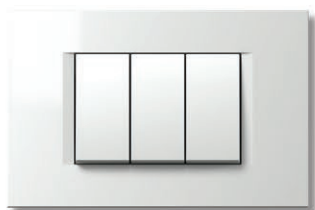
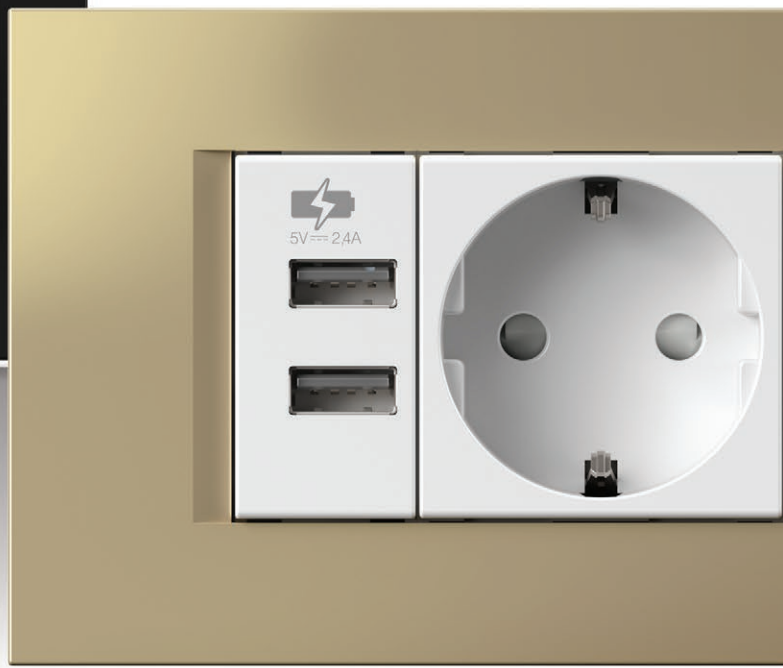

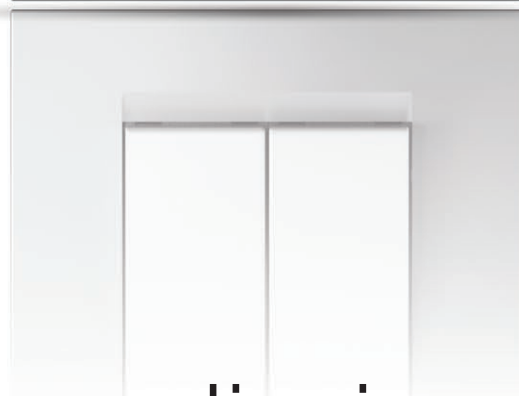
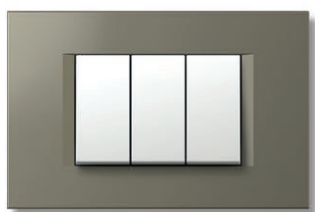
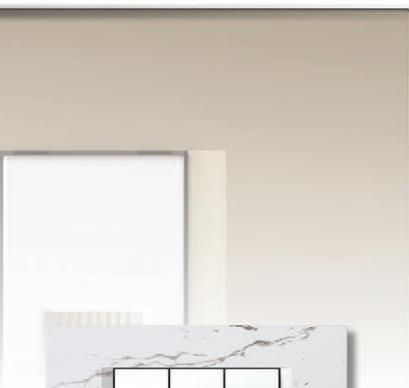

moderan dizajn

modern design

Čiste, ravne linije čine svezremenski dizajn. Savršeno ravan profil i ergonomija laganog dodira daju zapanjujuće elegantan izgled iz svih kutova.

Its straight, smooth lines make for a timeless design. Its perfectly straight, sleek profile and soft-touch ergonomics give it an amazingly elegant appearance from all angles.

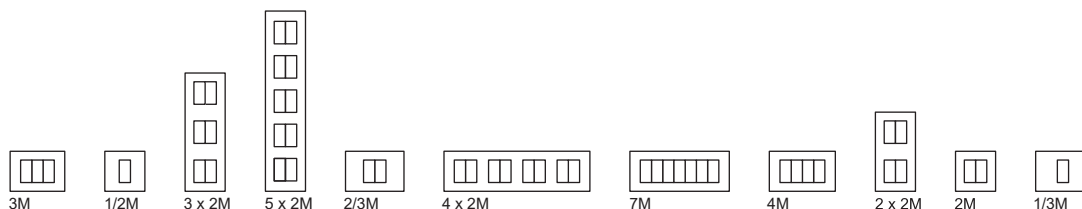

soft



mekoća u vašem domu

softness in your home

Neka okrugli oblici i meki prijelazi unesu mekoću u vaš dom.

Let the rounded shapes and soft transitions bring softness into your home.



soft

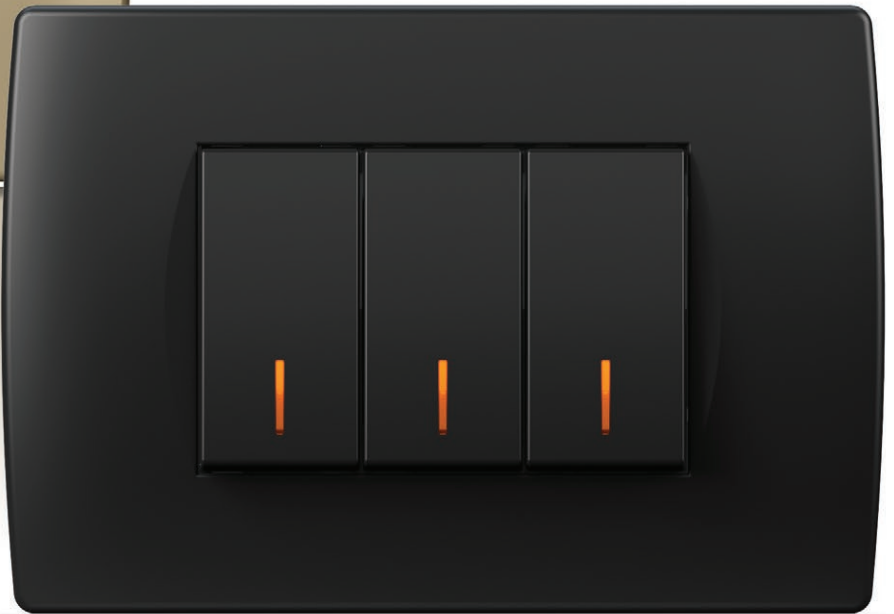



toplina doma a warm home

Savršeno meke linije zaokružene suptilnim odabirom boja i posebnim premazima za poseban dodir.

Perfectly soft shapes rounded off by a subtle selection of colours and special coatings for a special touch.

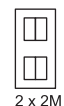
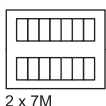



antracit

anthracite

Dodajemo dva doživljaja boja ANTRACIT i TITAN. Oba mogu zadovoljiti Vaš profinjen ukus i nadopuniti detalje prostora po Vašoj mjeri. Savršeni za harmoničnu nadogradnju Vašeg modernog, trendovskog stana.

We are adding two colour experiences to our range – ANTHRACITE and TITANIUM. They both satisfy our customer's sophisticated sense of style and complement the details of spaces according to their wishes. Now you can upgrade your modern apartment in harmony.

trendi boje

trendy colours



titan
titanium

multifunkcionalnost

multifunctionality



estetika

aesthetics

Za Vas smo pripremili veće okvire koji omogućuju multifunkcionalno upravljanje s jednog mjesta te su dostupni u linijama LINE, SOFT i PURE. Kod prirodnih materijala okvira to ponavljanje još više dolazi do izražaja na visokoj estetskoj razini.

We have created larger cover plates for you that allow you to manage multiple functions from one spot. They are available in the LINE, SOFT and PURE design ranges. The cover plates, which are made from natural materials, utilise the repetition of design elements to elevate them to a high aesthetic level.



univerzalni zatamnivač

universal dimmer

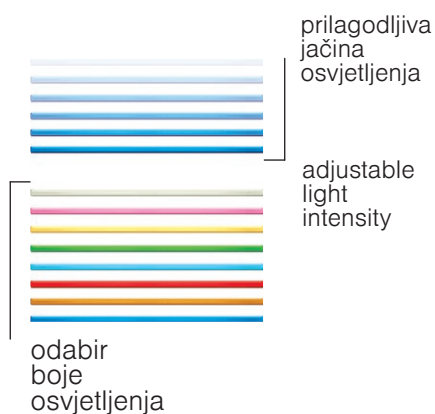

choosing
illumination
colour

U tami Touch postaje nježno meko ambijentalno svjetlo koje označava mjesto sklopke i nježno osvjetljava. Obilježava mjesto sklopke i nježno osvjetljava mjesto. Možete birati između osam različitih boja nježnog svjetla i prilagoditi jačinu ovisno o vašem raspoloženju.

In the dark Touch becomes a tender soft ambient light. It marks the spot of a switch and gently illuminates a place. You can choose among eight different colours of tender light and adapt its brightness according to your mood.

TOUCH®



svjetlo kakvo nije viđeno prije light as never seen before

Prigušeno svjetlo stvara mirnu, senzualnu i romantičnu atmosferu. To je osobina romantičnih mjesta i mirnih večernjih sati provedenih u domu ili na poslu. Uključivanje je meko i produženo. Ne samo da produžuje vijek trajanja žarulje, već mijenja tamu u svjetlo na sporiji i znatno ugodniji način. Touch vam omogućava zatamnivanje svjetla bilo gdje, neovisno o vrsti žarulje.

A dimmed light makes peaceful, sensual and romantic atmosphere. It is a trade mark of romantic places and quiet late evening hours spent at home or at work. Switching is soft and extended. It does not only prolong the lamp life expectancy, but also changes darkness into light in a slower and much more pleasant way. Touch enables you to dim the light anywhere, regardless of the type of lamps.



multimedija

multimedia



sve na jednome mjestu

everything in one place

Vaša je kuca središte vašeg života. Brojni uređaji koje koristite zahtijevaju niz konektora i utičnica. Stvorite vlastito multimedijско središte, koje će vam omogućiti povezivanje i korištenje brojnih komponenti, sve na jednom mjestu.

Your house is the centre of your life. The multitude of devices you use requires a number of connectors and sockets. Create your own multimedia centre, one that will allow you to connect and use a multiple number of different components in one place.



inovativna kontrola temperature

innovative temperature controller

Povećajte vlastitu udobnost kontroliranjem temperature u vašim životnim i radnim prostorijama tijekom svih godišnjih doba uz pomoć pametnog termostata. Omogućava vam upravljanje uređajima za grijanje i hlađenje, a ima i eko funkciju.

Make yourself comfortable by controlling the temperature in your living and working rooms during all seasons with a smart thermostat. It allows you to control heating and cooling devices and features an eco-function.

udobnost u vašem prostoru
comfort in your room



prikladnost korištenja

convenience of use



TOUCHLESS-bez dodira

Beskontaktna sklopka dopušta vam uživanje u modernom životnom stilu, omogućujući uključivanje i isključivanje svjetla bez potrebe za fizičkim dodiranjem. Ta je mogućnost vrlo korisna kada imate pune ruke ili uprljane jer možete postići željene osvjetljenje bez nepotrebnog napora.

The touchless switch allows you to enjoy a modern lifestyle, enabling the turning on and off of your lights, without the need for physical interaction. This option is very useful when you find yourself with your hands full, or dirty, as you can achieve the desired lighting without undue fuss.



moderno osvjetljenje

modern illumination





3D lampa

3D lamp

Užurbani tempo života izlaže vas konstantnom bombardiranju obiljem informacija. 3D lampe u boji pružaju elegantno rješenje za putokaze. Grafička rješenja možemo prilagoditi vašim željama.

The rapid pace of life means you are constantly being bombarded with a plenty of information. 3D colour lamp provide an elegant solution for information and direction signs. We can make graphics according to your wishes.



BIOPASS – otključavanje bez ključeva

BIOPASS – keyless unlocking

BIOPASS je nova generacija sklopki za otključavanje bez ključeva. Udružuje naprednu tehnologiju prepoznavanja otisaka prstiju i brzog otvaranja ulaznih vrata.

Samo položite svoj prst na sklopku Biopass i vrata vašeg doma ili ureda otvorit će se. Tako jednostavno i tako vrlo sigurno. Upravljanje je jednostavno s pomoću mobilne aplikacije.

BIOPASS is the new generation of switches for keyless unlocking. It combines advanced fingerprint recognition technology with quick front door opening.

Simply put your finger on the Biopass switch and the doors to your home or office will open. It is so easy to use and incredibly secure. You can manage it effortlessly via the mobile app.

poboljšana sigurnost
improved security



individualnost

individuality



načinite po svojem

make it your own

Budite drugačiji. Načinite sklopku po svojem ukusu. Možete odabrati između različitih boja okvira te ih za vas možemo ukrasiti prilagođenim grafičkim rješenjima ili znakovima. Odaberite boju osvjetljenja koja odgovara ambijentu vašeg prostora.

Be different. Make a switch according to your taste. You can choose between different frame colours and we can decorate them for you with custom graphics or signs. Choose a illumination colour that suits the ambience of your room.

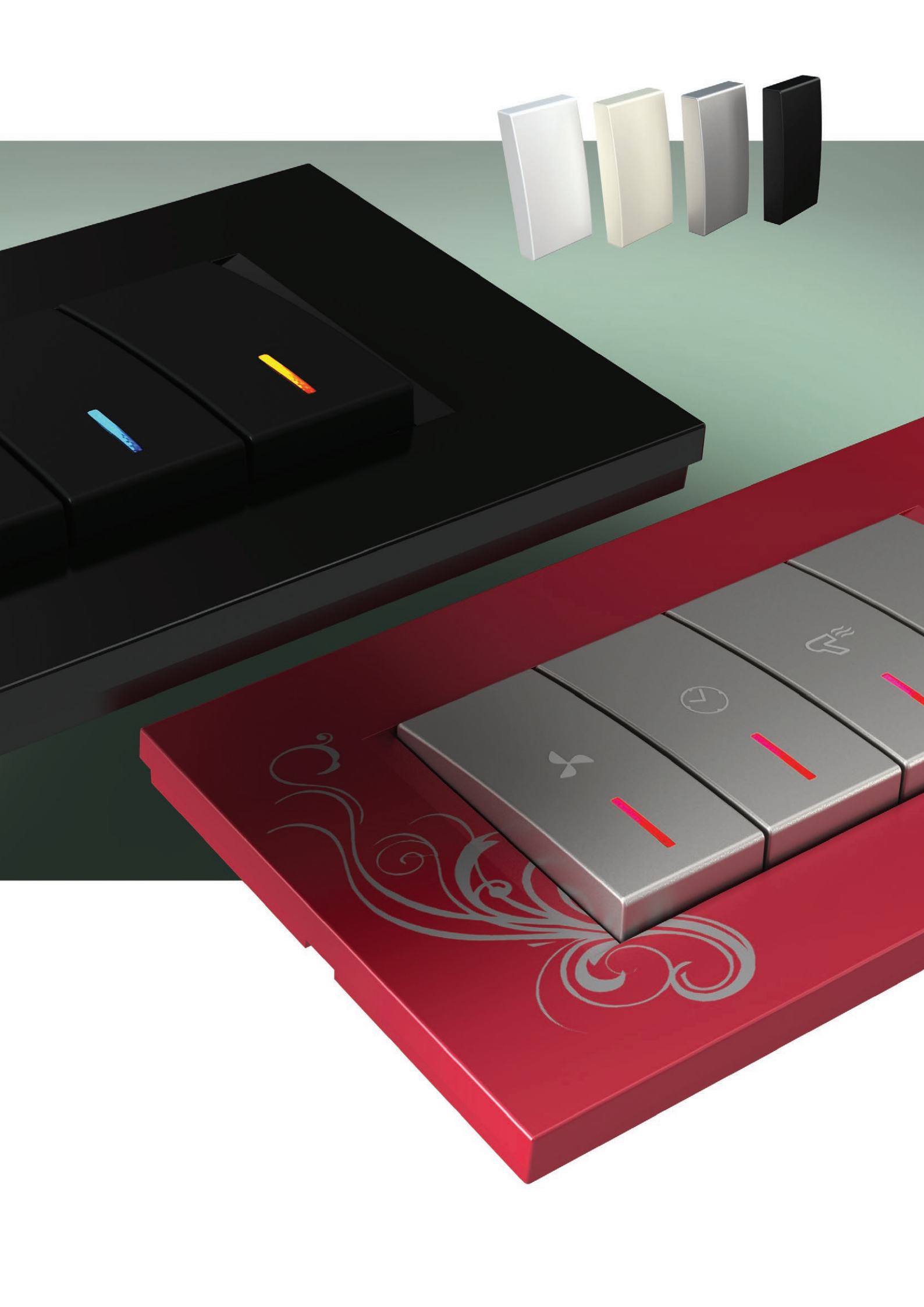

prikladno za javnu uporabu
suitable for public use



kvaliteta i izdržljivost quality and durability

Kvalitetni i izdržljivi materijali jamče dug životni vijek modularnih sklopki i utičnica MODUL. Zbog toga je ovaj sustav prikladan za ugradnju i bezbrižnu uporabu u javnim ustanovama, poslovnim zgradama, turističkim objektima, trgovačkim centrima, školama i sportskim objektima. Moguće ga je prilagoditi modernoj arhitekturi, ali i klasičnim interijerima.

Quality and durable materials ensure the long lifetime of the MODUL modular switches and sockets. The system is suitable for mounting and carefree use in public facilities, business premises, tourist accommodation, shopping centres, schools and sports facilities. It fits perfectly in both modern architecture and classical interiors.





snažni USB punjači powerful USB chargers

Uz pomoć snažnih USB punjača Modul moći ćete brzo i jednostavno napuniti pametne telefone, tablet računala i ostale e-uređaje putem standardnog USB priključka. Dostupni su u veličinama 1M i 2M. Savršeni su za korištenje, kako u privatnim, tako i u javnim prostorijama.

The powerful Modul USB chargers enable the fast and simple charging of your smartphones, tablets and other electronic devices via a standard USB connection. They are available in 1M and 2M sizes and are perfect for use in private and public rooms.

brzo punjenje
fast charging



moderno radno okruŹje a modern working environment





estetski aluminijski kanali

aesthetic aluminium trunkings

Pobrinite se za uređenost uredskih, školskih i radnih prostorija. Riješite se vidljivih kabela i nepraktičnih produžnih kabela. Elegantni aluminijski kanali modernog izgleda nude mnogo prostora za električne instalacije. Sklopke, utičnice i komunikacijski priključci brzo su dostupni i pri ruci tamo gdje su vam potrebni. Možete ih jednostavno zamijeniti ili naknadno dodati nove. Stvorite si ugodno i funkcionalno okruženje.

Organise your office, school and work areas. Forget visible cables and unpractical extensions. The elegant and modern aluminium trunkings offer plenty of space for electrical installations. Switches, sockets and communication elements are easily accessible and available in the right place to be used. They can be easily adapted or upgraded. Arrange a pleasant and functional environment for yourself.

modularnost

modularity

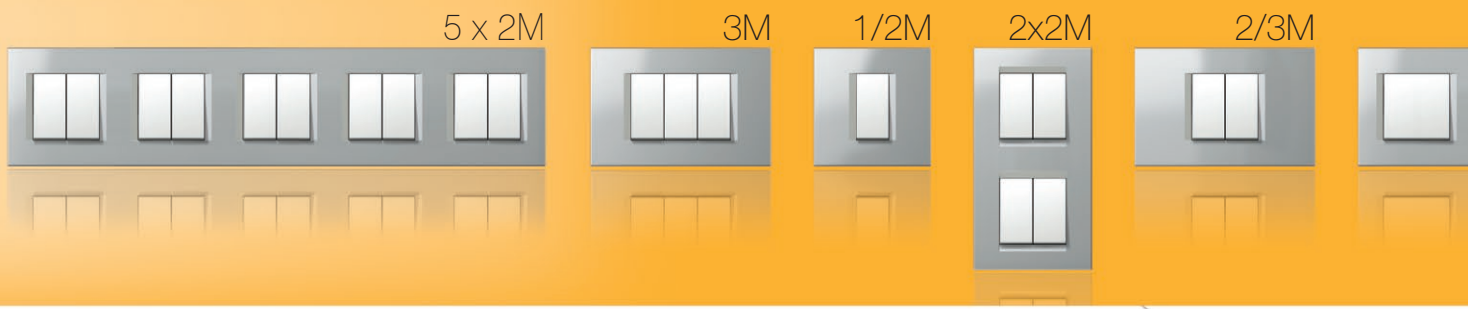

Dizajnirali smo sveobuhvatan sustav koji krasi raznoliki elementi, omogućavajući vam kreiranje bilo koje konfiguracije po vašim željama. Osnovni elementi sustava su modularni te mogu biti kombinirani horizontalno ili vertikalno.

We have designed a comprehensive system that features a variety of elements, allowing you to create any configuration you wish. The basic elements of the system are modular and can be combined horizontally or vertically.



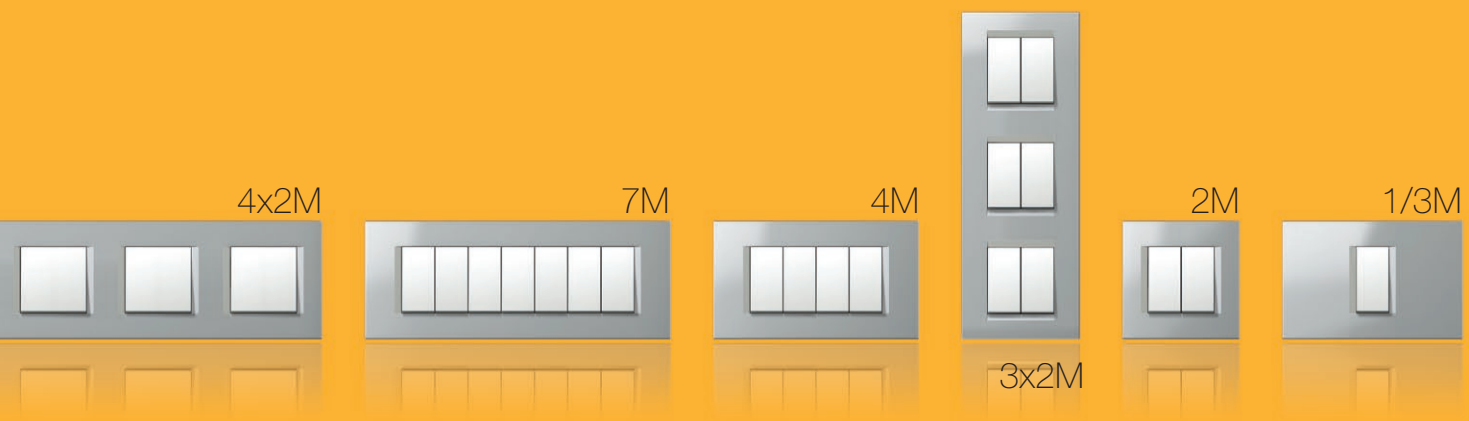

$$1M = \text{[rectangle]}$$

$$2M = \text{[rectangle]} \text{ [rectangle]} = \text{[square]}$$

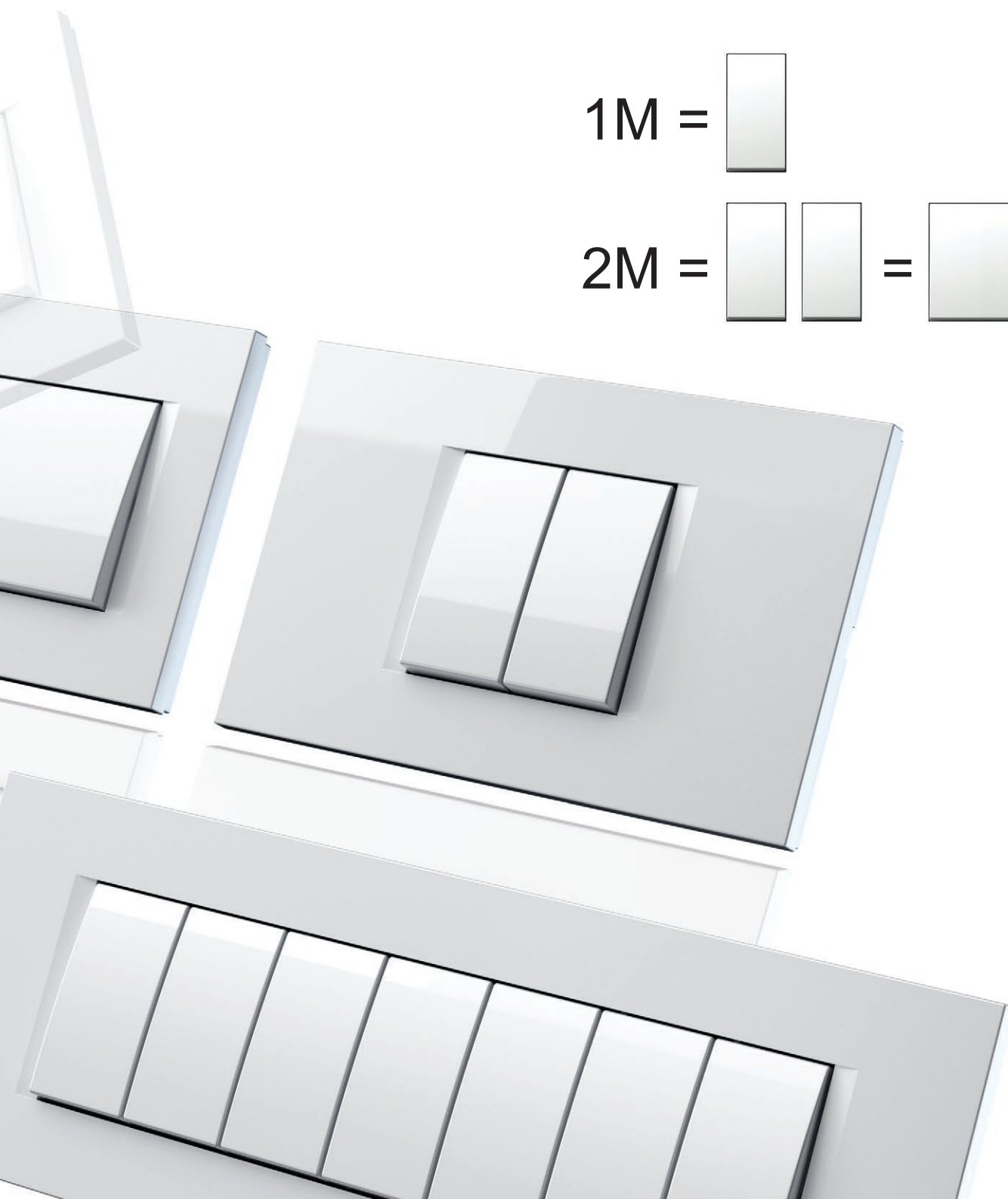

univerzalnost

Sustav krasi sveobuhvatan izbor elemenata te jednostavnost ugradnje. Setovi sklopki mogu biti postavljeni na različite načine, neovisno o tome je li kutija okrugla ili pravokutna, izdvojena ili u nizu.



modulmanager.tem.si



Iskušajte „ModulManager“ alat koji će vam pomoći da sastavite onu kombinaciju koju želite.

rješenja za 4 sklopke

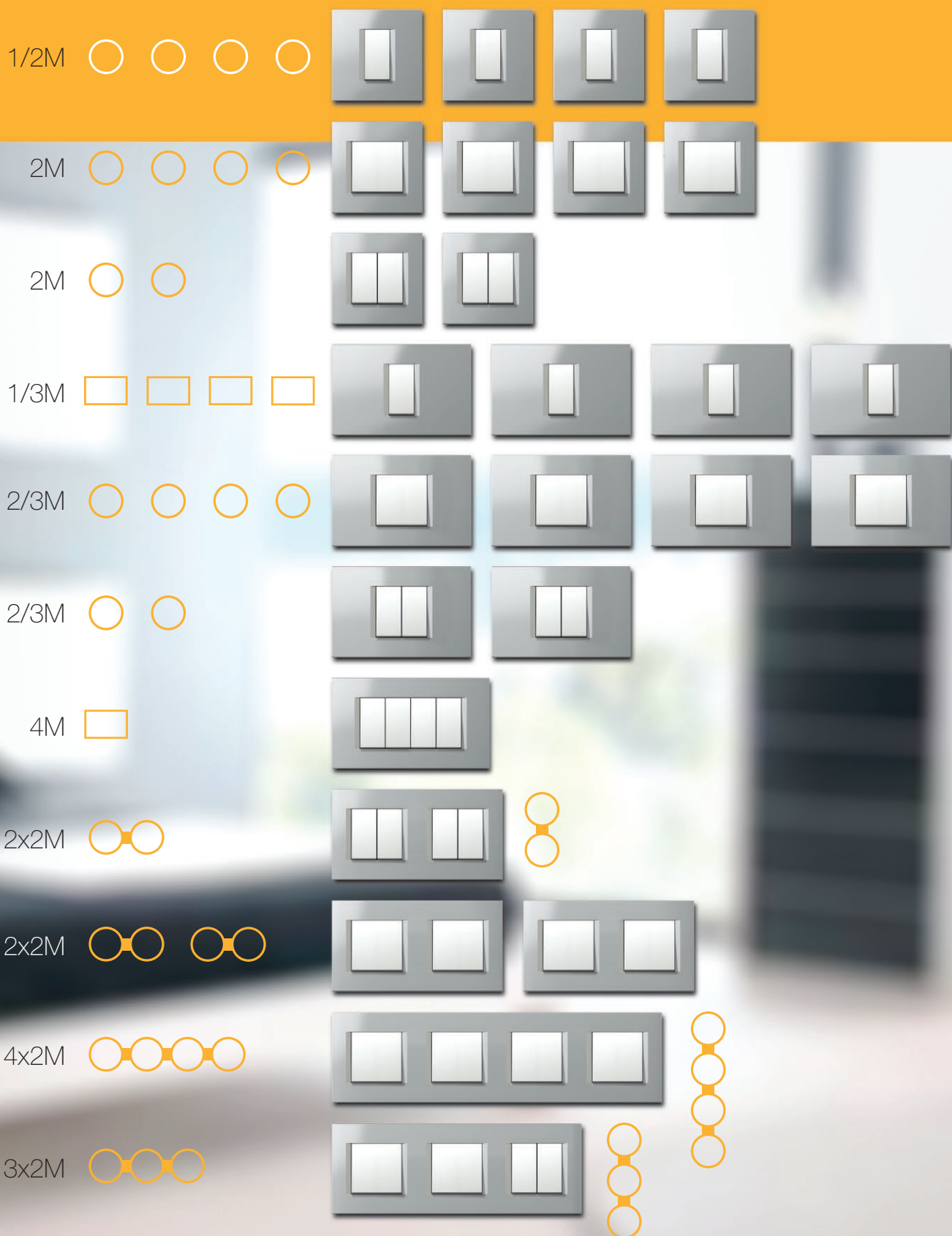

MODUL MANAGER

jednostavno i brzo / easy and fast





konfigurator sklopki i utičnica

configurator of switches and sockets

Modul manager vam omogućuje potpunu i brzu izradu popisa prekidača na gradilištu ili u kućnom naslonjaču. Za vas smo pripremili jedinstveni način naručivanja koji je praktičan i brz. Omogućeno vam je kreiranje boja prekidača i oblika okvira kako biste ih prilagodili vašem prostoru ili zahtjevu kupca. Isprobajte našu aplikaciju, potreban vam je samo mobilni telefon, tablet ili računalo i <http://modulmanager.tem.si>.

The Modul Manager allows you to perform a complete and quick inventory of switches from the building site itself or from the comfort of your own home. We have prepared a unique ordering method, which is both practical and quick. You can select the colours of the switches, as well as the shape of the frames, meaning you can tailor them to your space or the client's demands. Why not try us out? All you need is a smartphone, a tablet, or a computer and <http://modulmanager.tem.si>.

funkcionalnost

functionality

Modul je razvijen za one koji cijene pomno dizajniran proizvod. Sustav zauzima manje prostora jer bilo koja kombinacija funkcijskih elemenata može biti ugrađena u isti okvir. Prikladan je za nove i obnovljene građevine.

The Modul was developed for those who can appreciate a thoughtfully designed product. The system takes up less space, as any combination of function elements can be fitted inside the same cover plate. It is suitable for new, as well as renovated buildings.



Modul Soft je dostupan i s antibakterijskim rješenjem AB.

The Modul Soft is also available in an antibacterial solution AW.

dekorativni okviri
decorative cover plates

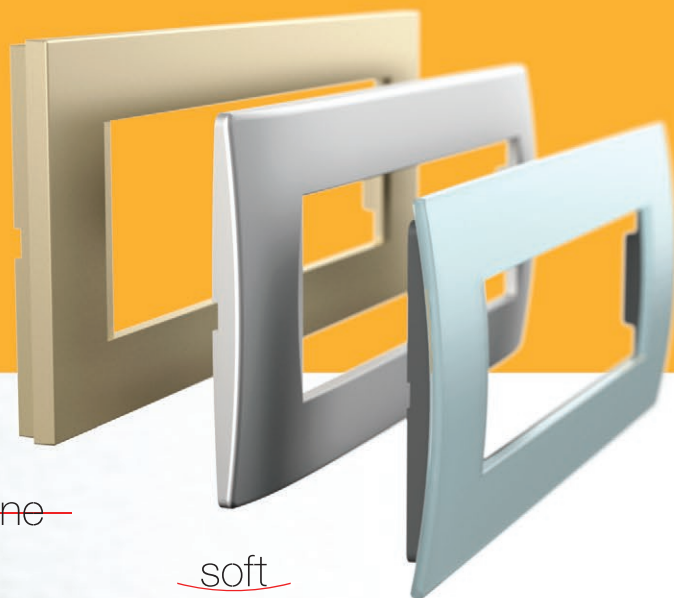

line

soft

PURE



funkcijski elementi
function elements



jednostavnost simplicity

Funkcijski elementi jednostavno se ugrađuju u nosač. Rješenje „klik-in, klik-out” koje smo za vas osmislili smanjit će vrijeme ugradnje. Kontakti spojeva lako su dostupni s prednje strane.

The function elements are easily fitted inside the mounting frame. The “klik-in, klik-out” solution we have developed for you will reduce installation time. The connection contacts are easily accessible from the front.

line
soft
PURE

klik-in, klik-out

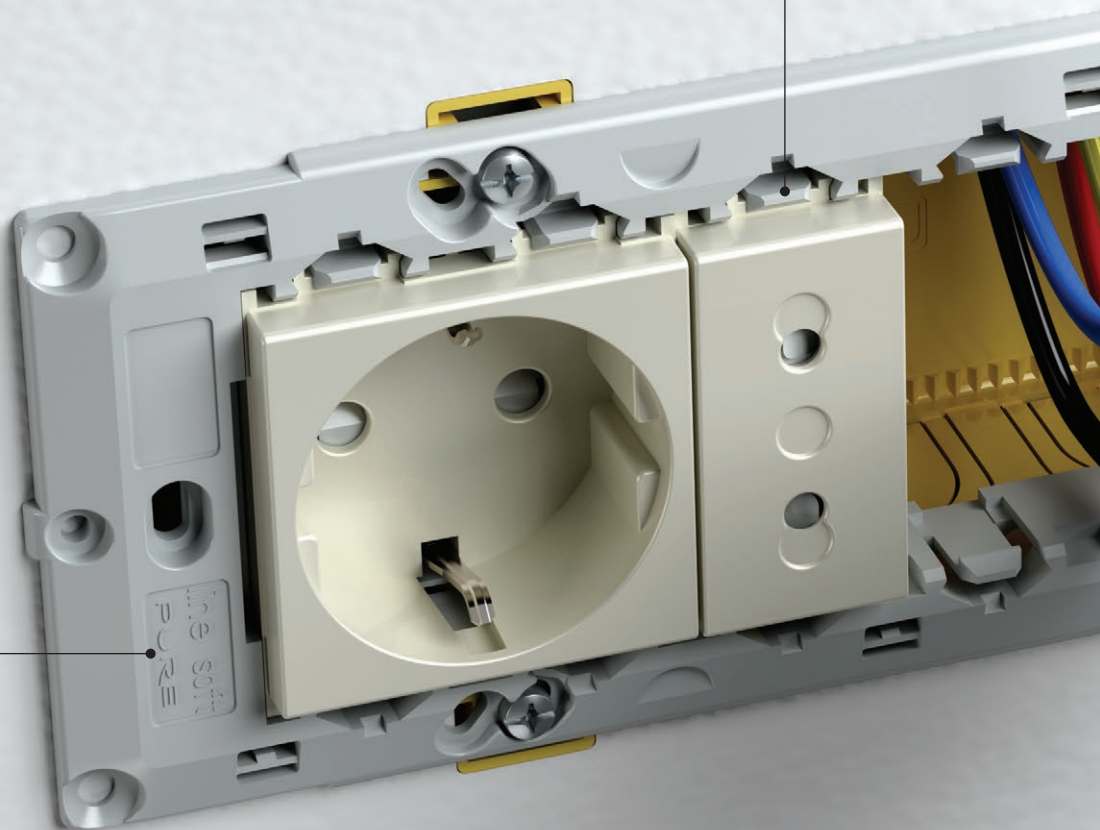

„Klick-out“ – brzo i jednostavno,
bez potrebe za vijcima.

“klik-out” - simple and quick,
no screws necessary.

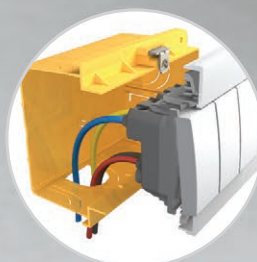

Pravokutne kutije imaju više mjesta
za žice spajanja.

Rectangular boxes have more
space for connection wires.

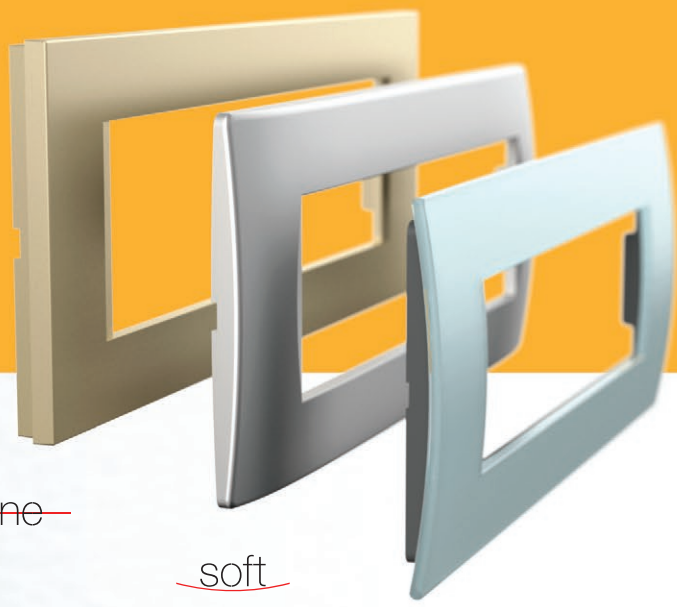
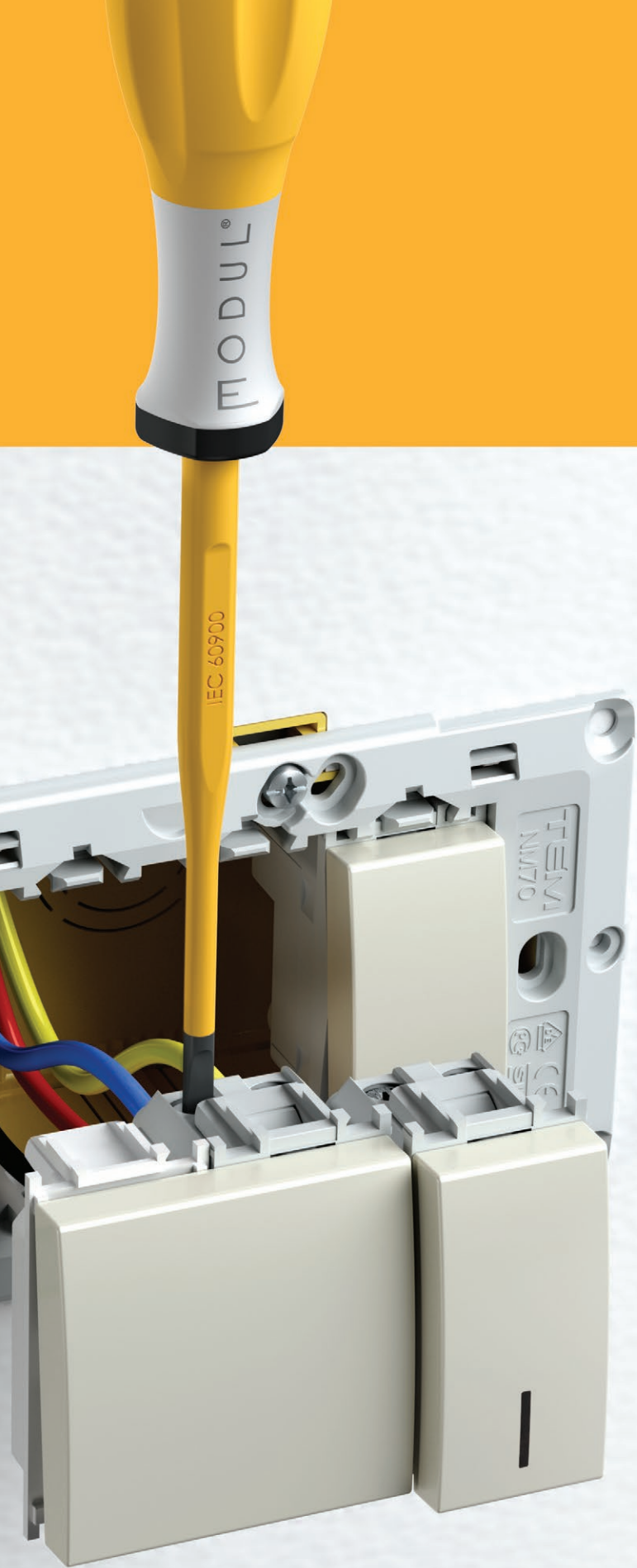

~~line~~

soft

PURE

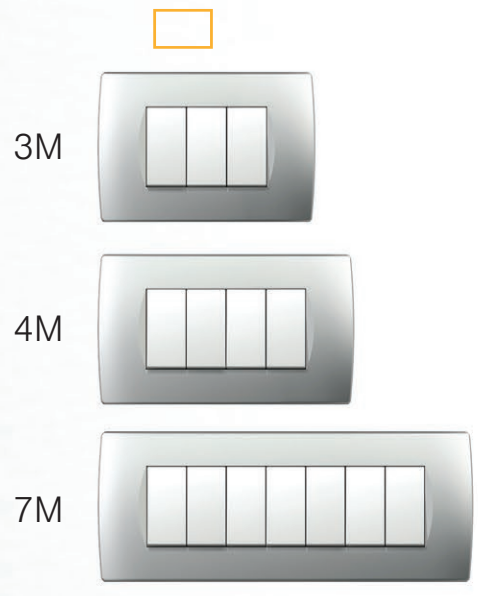

kombiniranje

combinability

Modul pruža brojne mogućnosti, čak i s okruglim kutijama. Možete ih kombinirati horizontalno ili vertikalno, zasebno ili u grupama. Metalni ugradbeni okvir osigurava izvrsnu stabilnost, čak i s grubim korištenjem, te je prikladan za sve okvire.

The Modul enables a many possibilities even with round boxes. You can combine them horizontally or vertically, individually or in groups. The metal mounting frame ensures excellent stability even with rough use and is suitable for any decorative cover plates.

line
soft
PURE

klik-in, klik-out

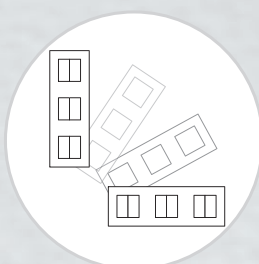
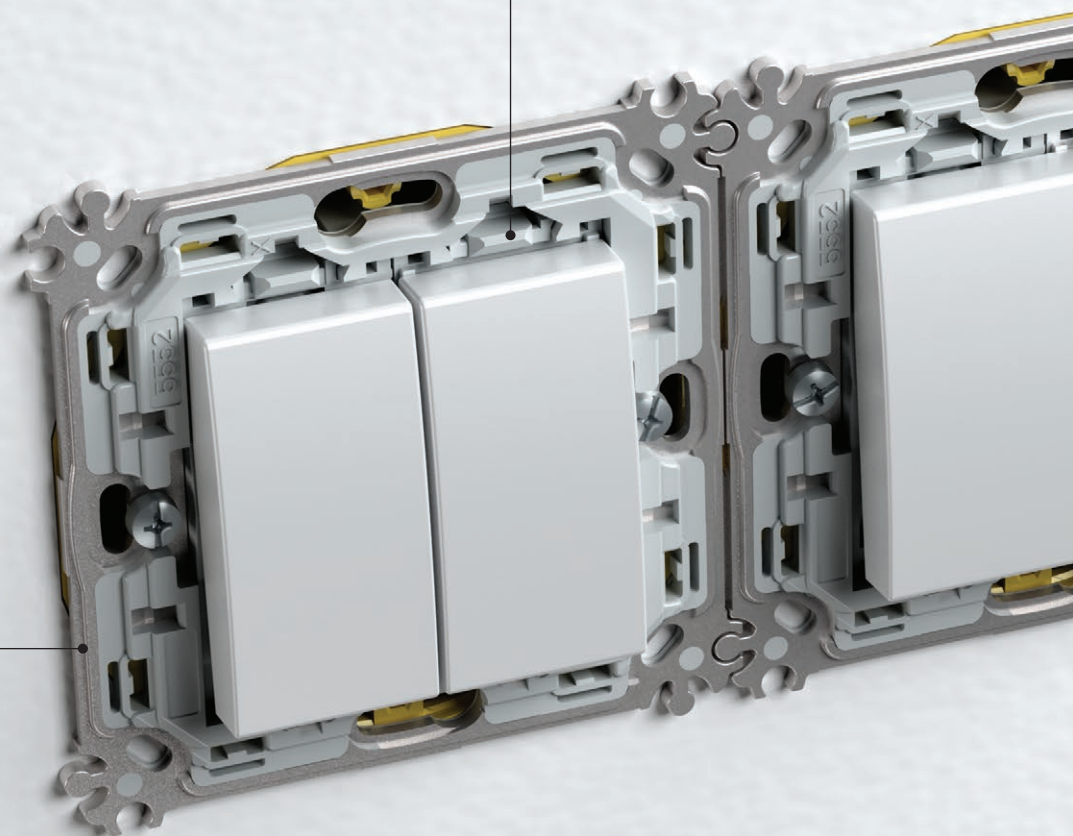

Isti okvir može biti postavljen horizontalno ili vertikalno.
The same cover plate can be positioned horizontally or vertically.

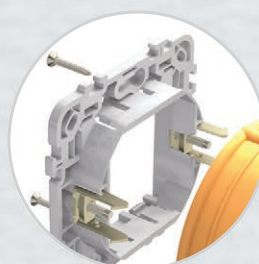

Ugradbeni okvir može biti pričvršćen vijcima ili zupčastim spojevima.
Mounting frames can be fixed with screws or claws.



~~line~~

soft

PURE



2M



2x2M

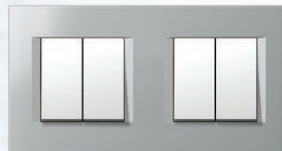

3x2M



4x2M



5x2M



2M ugradbeni okviri lako se spajaju u grupe.
2M mounting frames are easily joined into groups.

univerzalnost

universality

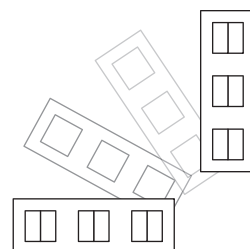
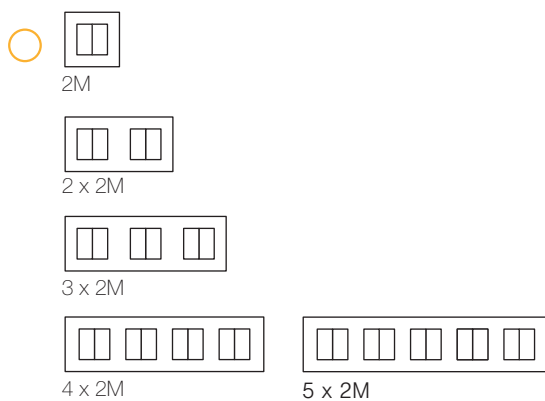
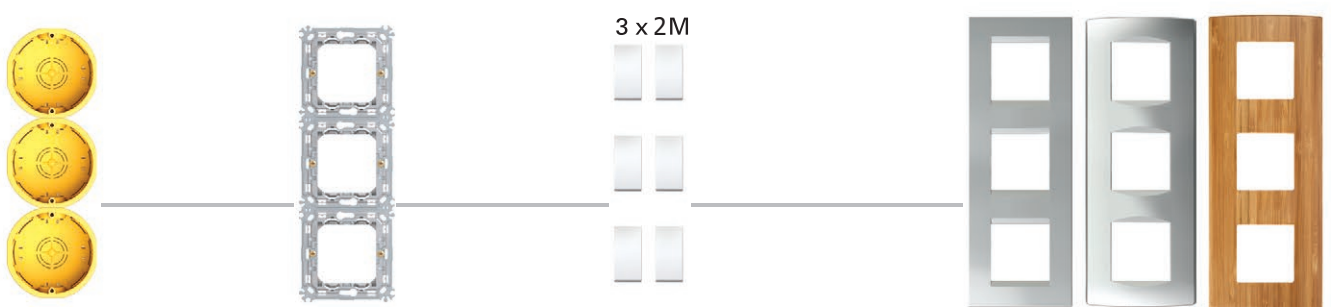
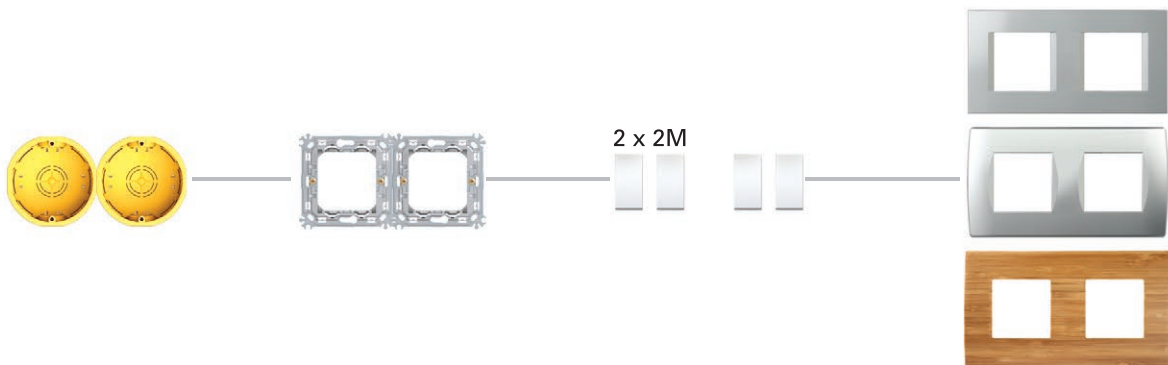
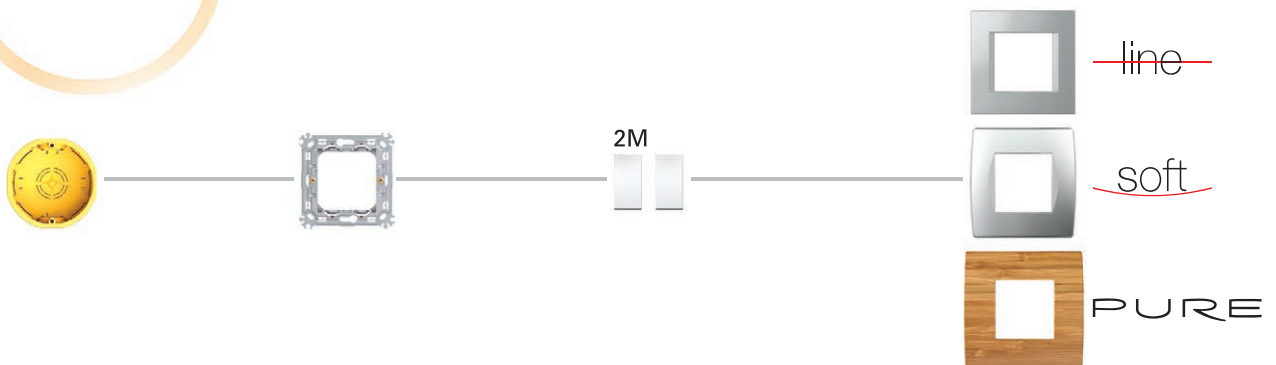

Sustav je univerzalan te se može ugraditi i u
okrugle i u pravokutne kutije.

The system is universal and can be fitted in both round and
rectangular boxes.

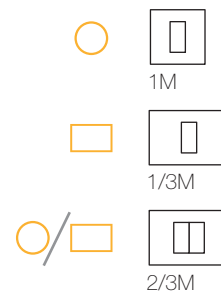
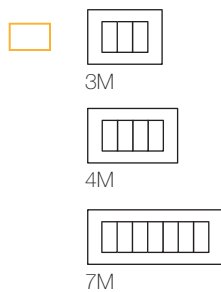
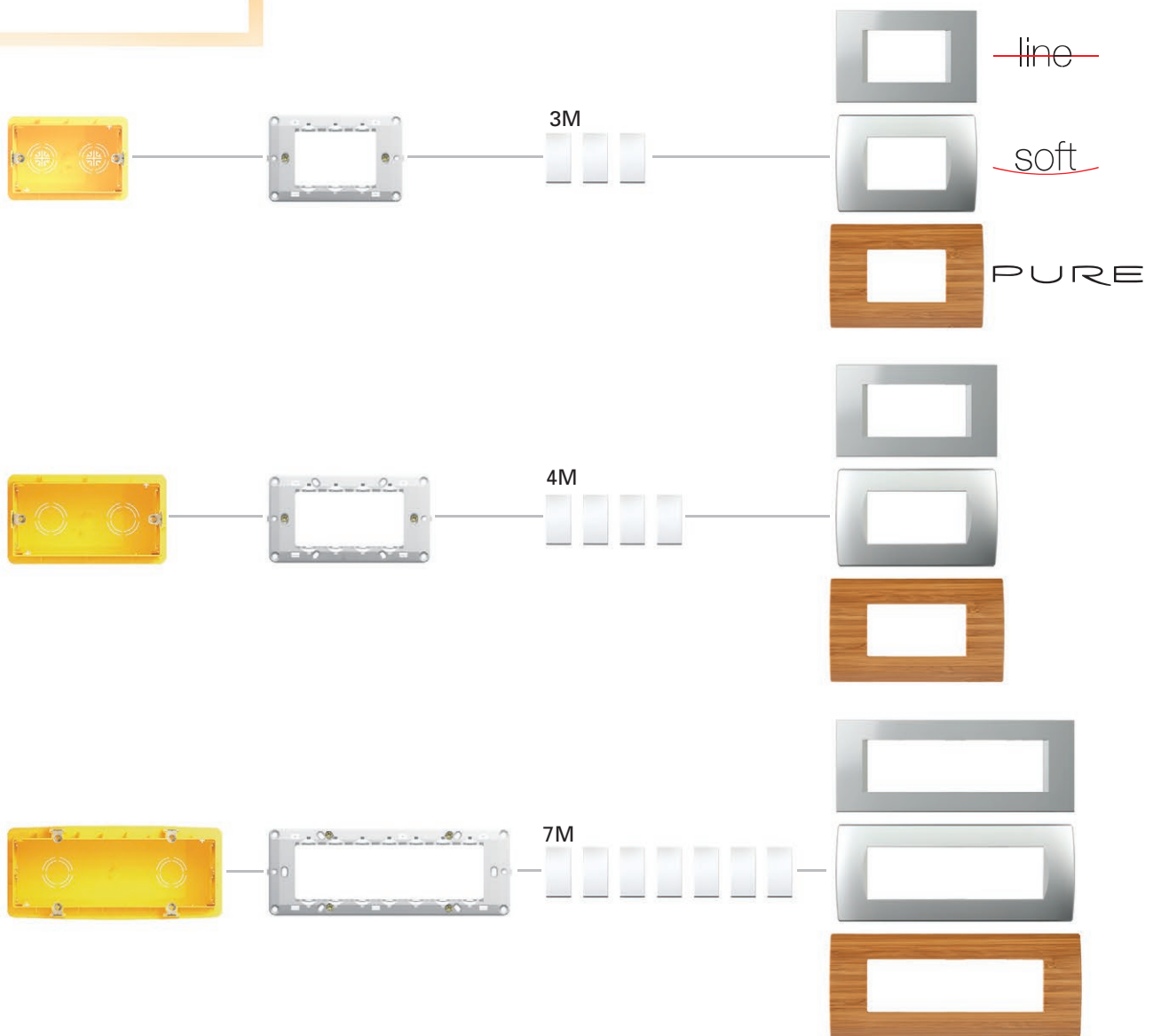
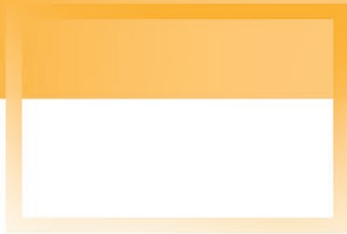

funkcijski elementi

function elements

• sklopke
switches



• ulaz
entrance

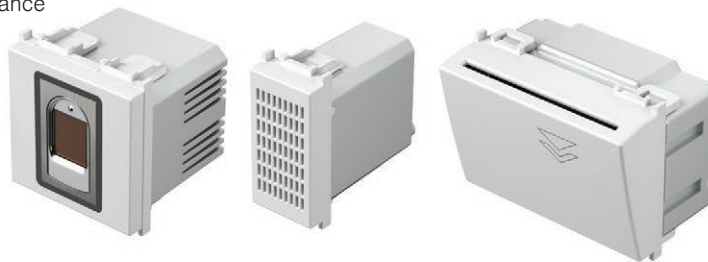

MODUL

• štednja energije
energy saving



Pouzdana spajanje kod korištenja žica različitih debljina.
Reliable connection even when different size of wires are used.



Dugotrajnost sklopki te uskladenost s međunarodnim standardima.
Long-life of switches and adequacy to the international standards.

Dizajnirali smo široku paletu funkcijskih elemenata za Modul obitelj.
Možete ih koristiti za dizajniranje jednostavnih i složenih instalacija.

We have designed a wide selection of function element for the Modul family. You can use them to design both simple and complex installations.



• utičnice
sockets

• zabava
entertainment

• osvjetljenje
illumination



Sve su uticnice opremljene sigurnosnim sklopovima koji osiguravaju zaštitu od kontakta s naponom.

All the sockets are equipped with a safety shutters assuring the protection to live contacts.



16 AX
kontakti

Sklopka je vrlo pouzdana zahvaljujući srebrnim zakovicama kontakata.

The switch is highly reliable via its silver rivets contacts.

jedinstven raspon iskoristivosti

unique range of usability

Modul Soft AW
antibakterijsko rješenje
antibacterial solution



MODUL

CUBO IP20

nadžbukna kutija
surface mounted boxes



CUBO IP55

nadžbukna kutija
surface mounted boxes



IP44

podžbukna ugradnja
flush mounted



Opremate li vaš dom, ured ili radionicu? Modul je prikladan kako za stambene, tako i za radne prostore te privatne i javne zgrade. Jedinstven je po tome što sklopke i utičnice mogu biti ugrađene gdje god se za to ukaže potreba.

Are you furnishing your home, office or workshop? The Modul is suitable for living as well as working spaces and both private and public buildings. It is unique in that the switches and sockets can be fitted wherever they are needed.

D

cigla
brick



H

šuplji zid
hollow wall



B

beton
concrete

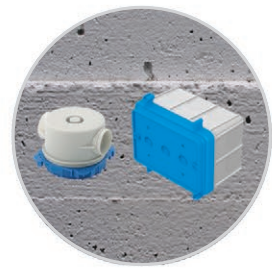

• funkcijski elementi /
function elements

sklopke / switches
utičnice / sockets
komunikacije / communications
senzori / sensors
regulatori / regulators
rasvjetna tijela / illuminations

MA

parapetni kanali
trunking systems



MO

razdjelni ormarići
distribution boards



MT

podne kutije
floor boxes



podžbukna rješenja

flush mounted solutions

cigla / brick

Modul je prikladan za sve vrste zidova te se može koristiti u konvencionalnm šupljim zidovima ili betonskim konstrukcijama. Jednostavno se ugrađuje i omogućuje vam kombiniranje pravokutnih ili okruglih kutija na odgovarajućoj udaljenosti. Materijali koji se koriste usklađeni su s visokim standardima.

The Modul is suitable for all wall types and can be used in conventional, hollow wall or concrete constructions. It is easy to install and enables you to combine rectangular or round boxes at the proper distances. The materials used are compliant with high standards.





ostala rješenja

other solutions

IP44
podžbukna ugradnja
flush mounted



CUBO IP20
nadžbukna kutija
surface mounted boxes

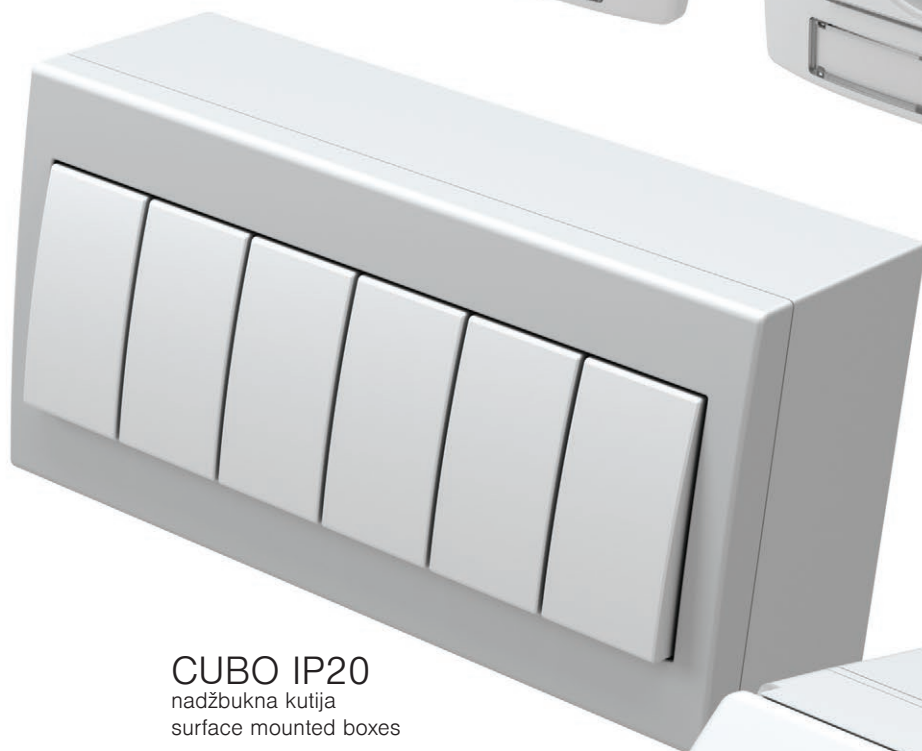

CUBO IP55
nadžbukna kutija
surface mounted boxes



Trebate li rješenje za sklopku ili utičnicu u nadžbuknoj, podžbuknoj ili podnoj varijanti? Modul pruža različita rješenja ugradnje s različitim IP zaštitama, za parapetne kanale, razdjelne ormariće ili podne kutije. Odabir je na vama.

Do you need switch or socket in flush, surface or floor solution? The Modul provides different mounting solutions with different IP protections, for trunking systems, distribution boards or floor boxes. The choice is yours.



MA

parapetni kanali
trunking systems

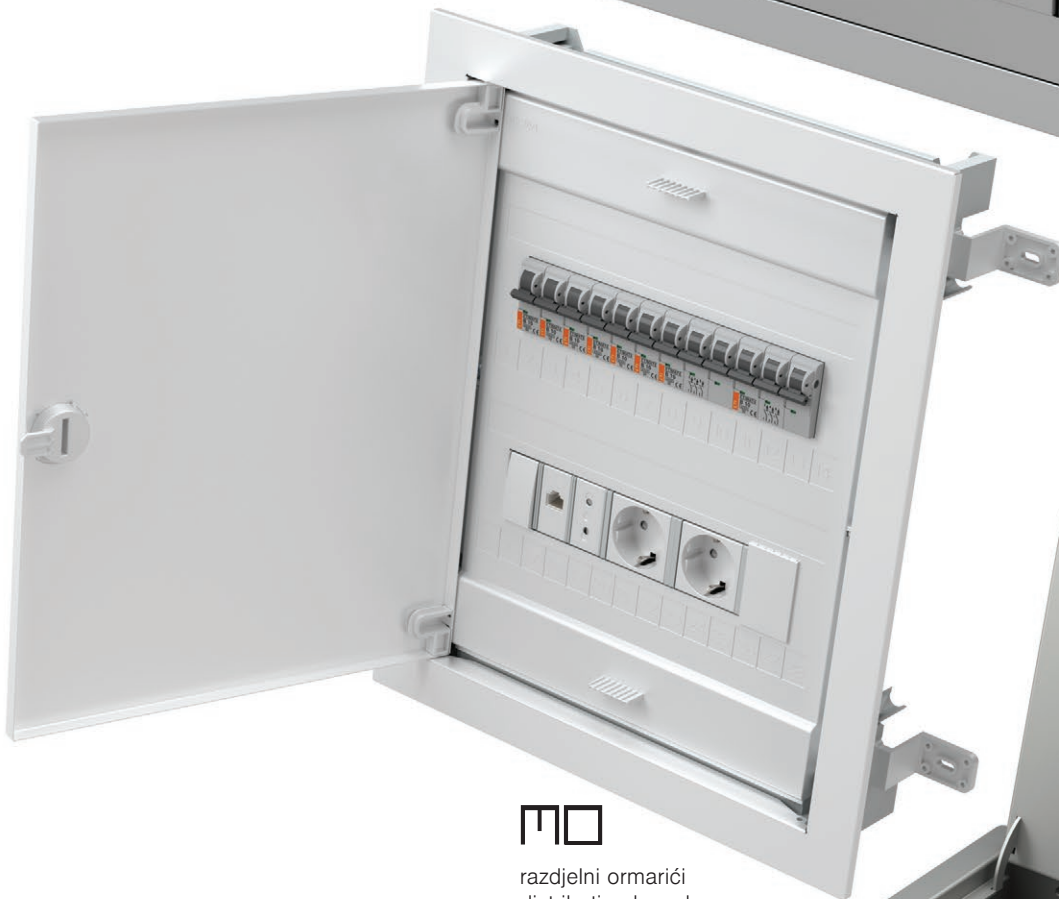

MO

razdjelni ormarići
distribution boards



MT

podne kutije
floor boxes

tehnički katalog

technical catalogue





MODUL

— funkcijski elementi
function elements



66

dizajn
design

PURE
line
soft



116

kutija
boxes



136

distribucija
distribution



158

ekonomik —



182

fontana —



210

TEM





FUNKCIJSKI ELEMENTI
FUNCTION ELEMENTS

SKLOPKE SM
SWITCHES SM



68

TIPKE TM
BUTTONS TM



73

OSVJETLJENJE IA
ILLUMINATION IA



76

UTIČNICE VM
SOCKETS VM



78

KOMUNIKACIJE KM
COMMUNICATIONS KM



82

DODACI KOMUNIKACIJA KA
COMMUNICATION ACCESSORIES KA



88

ELEKTRONIKA EM
ELECTRONICS EM



91

SETOVI CM
SETS CM



110

ANTIBAKTERIJSKI PROGRAM AW
ANTIBACTERIAL PROGRAM AW



115

DIZAJN
DESIGN

OKVIRI PURE OP
COVER PLATES PURE OP



120

OKVIRI LINE OL
COVER PLATES LINE OL



124

OKVIRI SOFT OS
COVER PLATES SOFT OS



128

NOSAČI NM
MOUNTING FRAMES NM



134

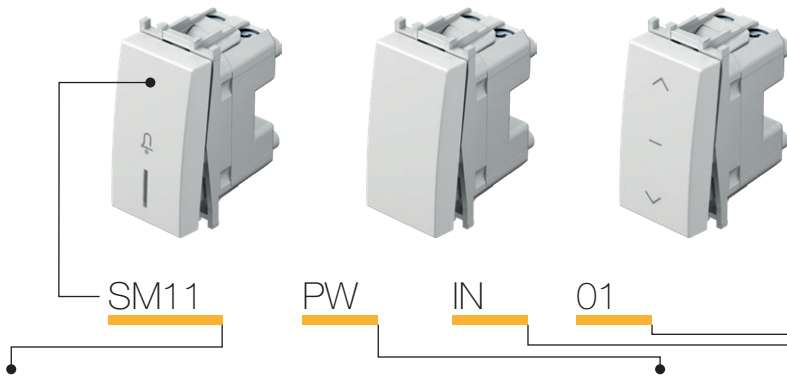

tip type	naziv description	tehnički podaci technical data	veličina size	boja colour	opcijski podaci 1 optional data 1	opcijski podaci 2 optional data 2
SM10	SKLOPKA JEDNOPOLNA SWITCH 1WAY	16AX 250V~	1M	□ PW bijela sjajna polar white	NT neutralna neutral	🔔 01
SM11	TIPKALO JEDNOPOLNO PUSH BUTTON 1WAY	16A 250V~	1M	■ SB crna mat soft touch black	IN indikator indicator	🔔 02
SM12	SKLOPKA JEDNOPOLNA SWITCH 1WAY	20A 250V~	1M	■ AT antracit anthracite		🔔 03
⋮	⋮	⋮	⋮	□ ES srebrna mat elox silver		🔔 03
⋮	⋮	⋮	⋮	■ IW bež sjajna ivory white		

SKLOPKA JEDNOPOLNA 16AX 250V~ 1M



SM10

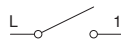

- sklopka bez tipke
 - 16AX 250V~, tip SM10
 - sukladno normi EN 60669-1
 - vijčano pričvršćivanje vodiča presjeka 1,5-2,5 mm²
- SWITCH 1WAY 16AX 250V~ 1M
- switch without button
 - 16AX 250V~, type SM10
 - in accordance with EN 60669-1
 - screw contacts 1.5-2.5mm²

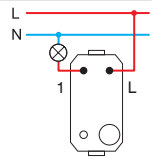

TIPKALO JEDNOPOLNO 16A 250V~ 1M



SM11



- tipkalo bez tipke
 - 16A 250V~, tip SM11
 - sukladno normi EN 60669-1
 - vijčano pričvršćivanje vodiča presjeka 1,5-2,5 mm²
- PUSH BUTTON 1WAY 16A 250V~ 1M
- push button without button
 - 16A 250V~, type SM11
 - in accordance with EN 60669-1
 - screw contacts 1.5-2.5mm²

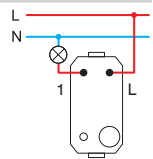

SKLOPKA JEDNOPOLNA 20A 250V~ 1M



SM12

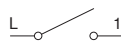

- sklopka bez tipke
 - 20A 250V~, tip SM12
 - sukladno normi EN 60669-1
 - vijčano pričvršćivanje vodiča presjeka 1,5-2,5 mm²
- SWITCH 1WAY 20A 250V~ 1M
- switch without button
 - 20A 250V~, type SM12
 - in accordance with EN 60669-1
 - screw contacts 1.5-2.5mm²

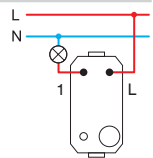

SKLOPKA DVOPOLNA 16AX 250V~ 1M



SM20

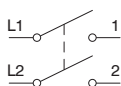

- sklopka bez tipke
 - 16AX 250V~, tip SM20
 - sukladno normi EN 60669-1
 - vijčano pričvršćivanje vodiča presjeka 1,5-2,5 mm²
 - samo u kombinaciji s tipkom TM15
- SWITCH 2POLE 16AX 250V~ 1M
- switch without button
 - 16AX 250V~, type SM20
 - in accordance with EN 60669-1
 - screw contacts 1.5-2.5mm²
 - only in combination with button TM15

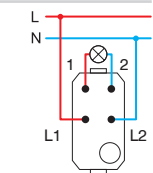



SM40

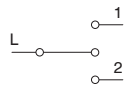

SKLOPKA ŽALUZIJSKA 1-0-2 16AX 250V~ 1M

- sklopka bez tipke
- 16AX 250V~, tip SM40
- sukladno normi EN 60669-1
- vijčano pričvršćivanje vodiča presjeka 1,5-2,5 mm²

SWITCH SHUTTERS 1-0-2 16AX 250V~ 1M

- switch without button
- 16AX 250V~, type SM40
- in accordance with EN 60669-1
- screw contacts 1.5-2.5mm²

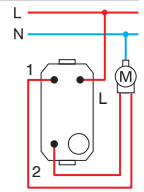

SM41

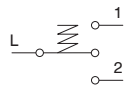

TIPKALO ŽALUZIJSKO 1-0-2 16A 250V~ 1M

- tipkalo bez tipke
- 16A 250V~, tip SM41
- sukladno normi EN 60669-1
- vijčano pričvršćivanje vodiča presjeka 1,5-2,5 mm²

PUSH BUTTON SHUTTERS 1-0-2 16A 250V~ 1M

- push button without button
- 16A 250V~, type SM41
- in accordance with EN 60669-1
- screw contacts 1.5-2.5mm²

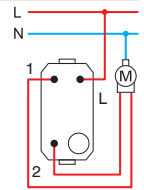

SM60

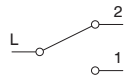

SKLOPKA IZMJENIČNA 16AX 250V~ 1M

- sklopka bez tipke
- 16AX 250V~, tip SM60
- sukladno normi EN 60669-1
- vijčano pričvršćivanje vodiča presjeka 1,5-2,5 mm²

SWITCH 2WAY 16AX 250V~ 1M

- switch without button
- 16AX 250V~, type SM60
- in accordance with EN 60669-1
- screw contacts 1.5-2.5mm²

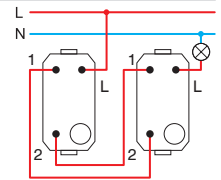

SM61

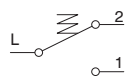

TIPKALO IZMJENIČNO 16A 250V~ 1M

- tipkalo bez tipke
- 16A 250V~, tip SM61
- sukladno normi EN 60669-1
- vijčano pričvršćivanje vodiča presjeka 1,5-2,5 mm²

PUSH BUTTON 2WAY 16A 250V~ 1M

- push button without button
- 16A 250V~, type SM61
- in accordance with EN 60669-1
- screw contacts 1.5-2.5mm²

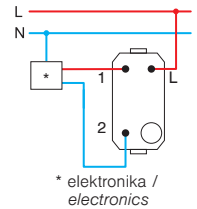

SM70

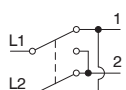

SKLOPKA KRIŽNA 16AX 250V~ 1M

- sklopka bez tipke
- 16AX 250V~, tip SM70
- sukladno normi EN 60669-1
- vijčano pričvršćivanje vodiča presjeka 1,5-2,5 mm²

SWITCH INTERMEDIATE 16AX 250V~ 1M

- switch without button
- 16AX 250V~, type SM70
- in accordance with EN 60669-1
- screw contacts 1.5-2.5mm²

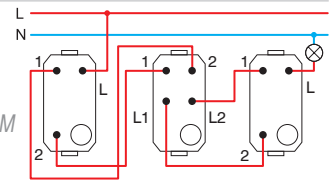

1M = 22,5 x 45
2M = 45 x 45

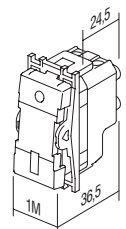
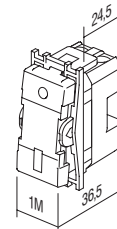



□ PW bijela sjajna
polar white



■ SB crna mat
soft touch black



■ AT antracit
anthracite



□ ES srebrna mat
elox silver



□ IW bež sjajna
ivory white

SKLOPKA JEDNOPOLNA 16AX 250V~ 1M



- SM10PW
- SM10SB
- SM10AT
- SM10ES
- SM10IW

- 16AX 250V~, tip SM10
- sukladno normi EN 60669-1
- vijčano pričvršćivanje vodiča presjeka 1,5-2,5 mm²
- zamjenjiva tipka

SWITCH 1WAY 16AX 250V~ 1M

- 16AX 250V~, type SM10
- in accordance with EN 60669-1
- screw contacts 1.5-2.5 mm²
- replaceable button



SKLOPKA JEDNOPOLNA 16AX 250V~ 1M __ IN



- SM10PWIN
- SM10SBIN
- SM10ATIN
- SM10ESIN
- SM10IWIN

- IN indikator
- 16AX 250V~, tip SM10
- sukladno normi EN 60669-1
- vijčano pričvršćivanje vodiča presjeka 1,5-2,5 mm²
- tinjalica nije ugrađena
- zamjenjiva tipka

SWITCH 1WAY 16AX 250V~ 1M __ IN

- IN indicator
- 16AX 250V~, type SM10
- in accordance with EN 60669-1
- screw contacts 1.5-2.5 mm²
- lamp is not included
- replaceable button



TIPKALO JEDNOPOLNO 16A 250V~ 1M



- SM11PW
- SM11SB
- SM11AT
- SM11ES
- SM11IW

- 16A 250V~, tip SM11
- sukladno normi EN 60669-1
- vijčano pričvršćivanje vodiča presjeka 1,5-2,5 mm²
- zamjenjiva tipka

PUSH BUTTON 1WAY 16A 250V~ 1M

- 16A 250V~, type SM11
- in accordance with EN 60669-1
- screw contacts 1.5-2.5 mm²
- replaceable button



TIPKALO JEDNOPOLNO 16A 250V~ 1M __ IN 01



- SM11PWIN01
- SM11SBIN01
- SM11ATIN01
- SM11ESIN01
- SM11IWIN01

- indikatorsko zvono IN 01
- 16A 250V~, tip SM11
- sukladno normi EN 60669-1
- vijčano pričvršćivanje vodiča presjeka 1,5-2,5 mm²
- tinjalica nije ugrađena
- zamjenjiva tipka

PUSH BUTTON 1WAY 16A 250V~ 1M __ IN 01

- IN 01 indicator bell
- 16A 250V~, type SM11
- in accordance with EN 60669-1
- screw contacts 1.5-2.5 mm²
- lamp is not included
- replaceable button



TIPKALO JEDNOPOLNO 16A 250V~ 1M __ IN 02



- SM11PWIN02 - svjetlosna indikacija IN 02
- SM11SBIN02 - 16A 250V~, tip SM11
- SM11ATIN02 - sukladno normi EN 60669-1
- SM11ESIN02 - vijčano pričvršćivanje vodiča presjeka 1,5-2,5 mm²
- SM11WIN02 - tinjalica nije ugrađena
- SM11WIN02 - zamjenjiva tipka

PUSH BUTTON 1WAY 16A 250V~ 1M __ IN 02

- IN 02 indicator light
- 16A 250V~, type SM11
- in accordance with EN 60669-1
- screw contacts 1.5-2.5 mm²
- lamp is not included
- replaceable button



SKLOPKA DVOPOLNA 16AX 250V~ 1M __ NT 03



- SM20PWNT03 - NT 03 neutralna 0-1
- SM20SBNT03 - 16AX 250V~, tip SM20
- SM20ATNT03 - sukladno normi EN 60669-1
- SM20ESNT03 - vijčano pričvršćivanje vodiča presjeka 1,5-2,5 mm²
- SM20IWNTO3 - zamjenjiva tipka

SWITCH 2POLE 16AX 250V~ 1M __ NT 03

- NT 03 neutral 0-1
- 16AX 250V~, type SM20
- in accordance with EN 60669-1
- screw contacts 1.5-2.5 mm²
- replaceable button



SKLOPKA DVOPOLNA 16AX 250V~ 1M __ IN



- SM20PWIN - IN indikator
- SM20SBIN - 16AX 250V~, tip SM20
- SM20ATIN - sukladno normi EN 60669-1
- SM20ESIN - vijčano pričvršćivanje vodiča presjeka 1,5-2,5 mm²
- SM20IWIN - tinjalica nije ugrađena
- SM20IWIN - zamjenjiva tipka

SWITCH 2POLE 16AX 250V~ 1M __ IN

- IN indicator
- 16AX 250V~, type SM20
- in accordance with EN 60669-1
- screw contacts 1.5-2.5 mm²
- lamp is not included
- replaceable button



SKLOPKA ŽALUZIJSKA 1-0-2 16AX 250V~ 1M __ NT 10

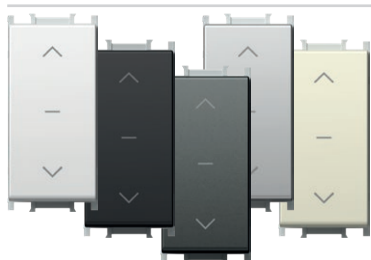

- SM40PWNT10 - NT 10 neutralna 1-0-2
- SM40SBNT10 - 16AX 250V~, tip SM40
- SM40ATNT10 - sukladno normi EN 60669-1
- SM40ESNT10 - vijčano pričvršćivanje vodiča presjeka 1,5-2,5 mm²
- SM40IWNTO3 - zamjenjiva tipka

SWITCH SHUTTERS 1-0-2 16AX 250V~ 1M __ NT 10

- NT 10 neutral 1-0-2
- 16AX 250V~, type SM40
- in accordance with EN 60669-1
- screw contacts 1.5-2.5mm²
- replaceable button



TIPKALO ŽALUZIJSKO 1-0-2 16A 250V~ 1M __ NT 10

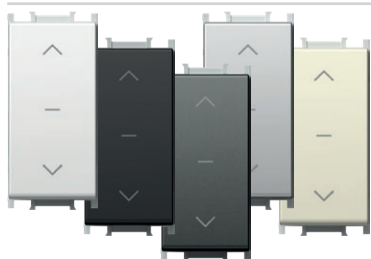

- SM41PWNT10 - NT 10 neutralna 1-0-2
- SM41SBNT10 - 16A 250V~, tip SM41
- SM41ATNT10 - sukladno normi EN 60669-1
- SM41ATNT10 - vijčano pričvršćivanje vodiča presjeka 1,5-2,5 mm²
- SM41ESNT10 - zamjenjiva tipka

PUSH BUTTON SHUTTERS 1-0-2 16A 250V~ 1M __ NT 10

- NT 10 neutral 1-0-2
- 16A 250V~, type SM41
- in accordance with EN 60669-1
- screw contacts 1.5-2.5mm²
- replaceable button



SKLOPKA IZMJENIČNA 16AX 250V~ 1M

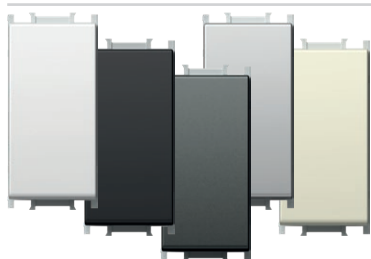

- SM60PW - 16AX 250V~, tip SM60
- SM60SB - sukladno normi EN 60669-1
- SM60AT - vijčano pričvršćivanje vodiča presjeka 1,5-2,5 mm²
- SM60ES - zamjenjiva tipka

SWITCH 2WAY 16AX 250V~ 1M

- 16AX 250V~, type SM60
- in accordance with EN 60669-1
- screw contacts 1.5-2.5 mm²
- replaceable button



TIPKALO IZMJENIČNO 16A 250V~ 1M



- SM61PW
- SM61SB
- SM61AT
- SM61ES
- SM61IW

- 16A 250V~, tip SM61
- sukladno normi EN 60669-1
- vijčano pričvršćivanje vodiča presjeka 1,5-2,5 mm²
- zamjenjiva tipka

PUSH BUTTON 2WAY 16A 250V~ 1M

- 16A 250V~, type SM61
- in accordance with EN 60669-1
- screw contacts 1.5-2.5 mm²
- replaceable button



TIPKALO IZMJENIČNO S UZICOM 16A 250V~ 1M __ CD



- SM62PWCD
- SM62SBCD
- SM62ATCD
- SM62ESCD
- SM62IWCD

- CD indikator + uzica
- duljina uzice 1,5 m
- 16A 250V~, tip SM62
- sukladno normi EN 60669-1
- vijčano pričvršćivanje vodiča presjeka 1,5-2,5 mm²

PUSH BUTTON 2WAY WITH CORD 16A 250V~ 1M __ CD

- CD indicator+cord
- cord lenght 1.5m
- 16A 250V~, type SM62
- in accordance with EN 60669-1
- screw contacts 1.5-2.5 mm²



SKLOPKA KRIŽNA 16AX 250V~ 1M



- SM70PW
- SM70SB
- SM70AT
- SM70ES
- SM70IW

- 16AX 250V~, tip SM70
- sukladno normi EN 60669-1
- vijčano pričvršćivanje vodiča presjeka 1,5-2,5 mm²
- zamjenjiva tipka

SWITCH INTERMEDIATE 16AX 250V~ 1M

- 16AX 250V~, type SM70
- in accordance with EN 60669-1
- screw contacts 1.5-2.5 mm²
- replaceable button



1M = 22,5 x 45
2M = 45 x 45

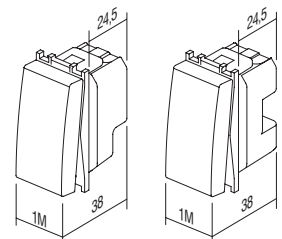

BUTTONS T M

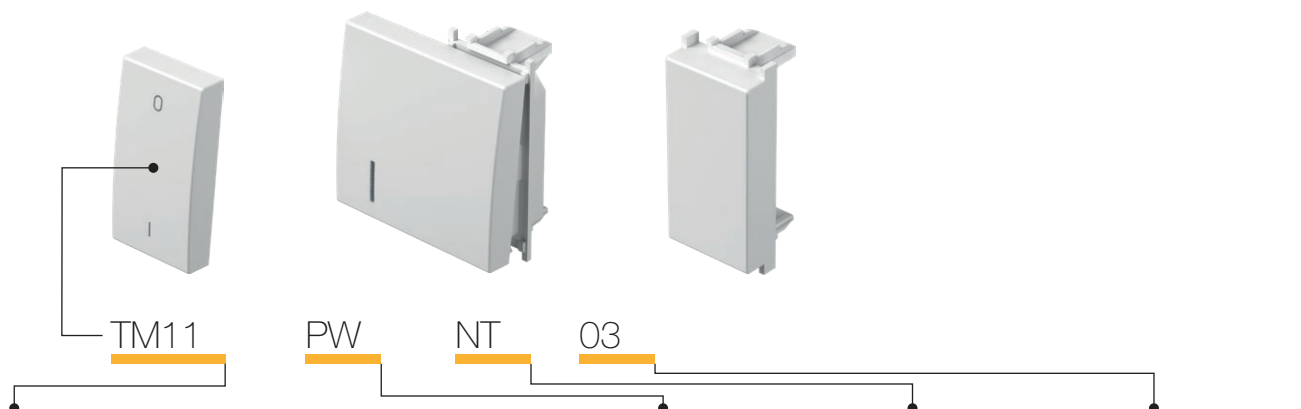

tip type	naziv description	veličina size	boja colour	opcijski podaci 1 optional data 1	opcijski podaci 2 optional data 2
TM11	TIPKA BUTTON	1M	<input type="checkbox"/> PW bijela sjajna polar white <input type="checkbox"/> SB crna mat soft touch black <input type="checkbox"/> AT antracit anthracite <input type="checkbox"/> ES srebrna mat elox silver <input type="checkbox"/> IW bež sjajna ivory white	NT neutralna neutral IN indikator indicator	01 02 03
TM12	TIPKA BUTTON	2M			
TM21	SLIJEPI ELEMENT BLANK	1M			
.

TIPKA 1M



- TM11PW
- TM11SB
- TM11AT
- TM11ES
- TM11IW

- zamjenjiva tipka 1M
- sukladno normi EN 60669-1
BUTTON 1M
- replaceable button 1M
- in accordance with EN 60669-1



TIPKA 1M INDIKATOR



- TM11PWIN
- TM11ATIN
- TM11SBIN
- TM11ESIN
- TM11IWIN

- zamjenjiva tipka 1M
- sukladno normi EN 60669-1
BUTTON 1M INDICATOR
- replaceable button 1M
- in accordance with EN 60669-1



TIPKA 2M

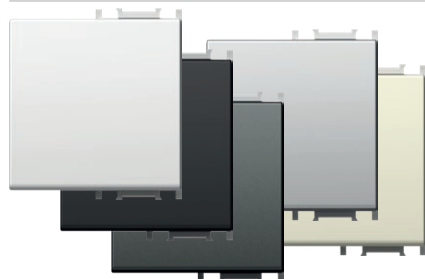

- TM12PW
- TM12SB
- TM12AT
- TM12ES
- TM12IW

- zamjenjiva tipka 2M s nosačem tipke
- za nadogradnju sklopke ili tipke
s veličine 1M na veličinu 2M.
- sukladno normi EN 60669-1
BUTTON 2M
- replaceable button 2M with button carrier
- to upgrade switch or push button
from size 1M to size 2M
- in accordance with EN 60669-1



TIPKA 2M INDIKATOR

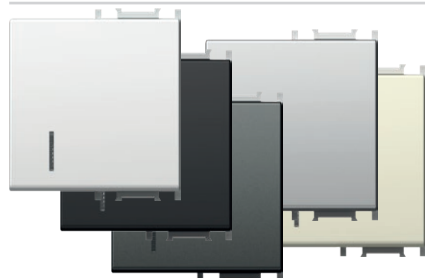

- TM12PWIN
- TM12SBIN
- TM12ATIN
- TM12ESIN
- TM12IWIN

- zamjenjiva tipka 2M s nosačem tipke
- za nadogradnju sklopke ili tipke
s veličine 1M na veličinu 2M.
- sukladno normi EN 60669-1
BUTTON 2M INDICATOR
- replaceable button 2M with button carrier
- to upgrade switch or push button
from size 1M to size 2M
- in accordance with EN 60669-1



TIPKA 2M S NATPISNOM PLOČICOM

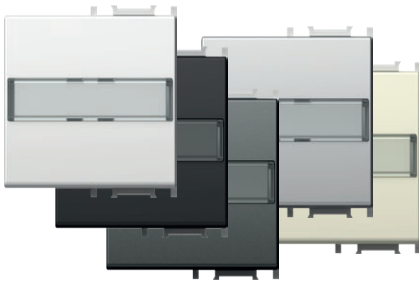

- TM13PWIL
- TM13SBIL
- TM13ATIL
- TM13ESIL
- TM13IWIL

- zamjenjiva tipka 2M s nosačem tipke
 - upotrebljava se pri nadogradnji sklopke ili tipkala od veličine 1M na veličinu 2M
 - sukladno normi EN 60669-1

BUTTON 2M WITH INSCRIPTION PLATE

- replaceable button 2M with button carrier
 - to upgrade switch or push button from size 1M to size 2M
 - in accordance with EN 60669-1



TIPKA 1M DVOPOLNA

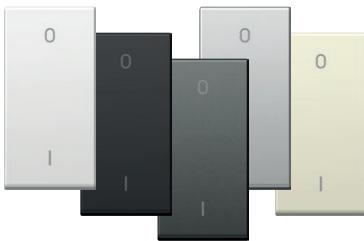

- TM15PW
- TM15SB
- TM15AT
- TM15ES
- TM15IW

- zamjenjiva tipka 1M
 - samo u kombinaciji s mehanizmom SM20
 - sukladno normi EN 60669-1

BUTTON 1M 2POLE

- replaceable button 1M
 - only in combination with mechanism SM20
 - in accordance with EN 60669-1



SLIJEPI ELEMENT 1M

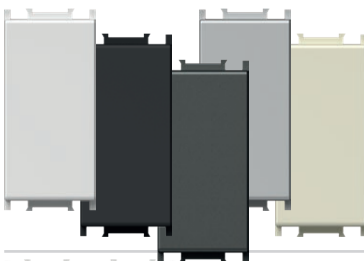

- TM21PW
- TM21SB
- TM21AT
- TM21ES
- TM21IW

- slijepi element za popunjavanje praznog mjesta
 - sukladno normi EN 60669-1

BLANK 1M

- blank modul to fill up empty spaces
 - in accordance with EN 60669-1



SLIJEPI ELEMENT 2M



- TM22PW
- TM22SB
- TM22AT
- TM22ES
- TM22IW

- slijepi element za popunjavanje praznog mjesta
 - sukladno normi EN 60669-1

BLANK 2M

- blank modul to fill up empty spaces
 - in accordance with EN 60669-1



UVODNICA 1M

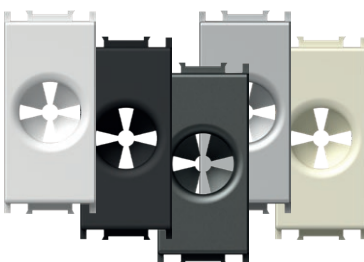

- TM31PW
- TM31SB
- TM31AT
- TM31ES
- TM31IW

- uvodnica za kabel
 - sukladno normi EN-60669-1

CABLE OUTLET 1M

- outlet for cable
 - in accordance with EN-60669-1



1M = 22,5 x 45
 2M = 45 x 45

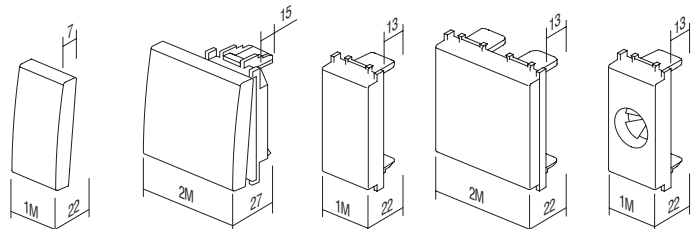

TM11
 TM15

TM12
 TM13

TM21

TM22

TM31

BUTTONS T M

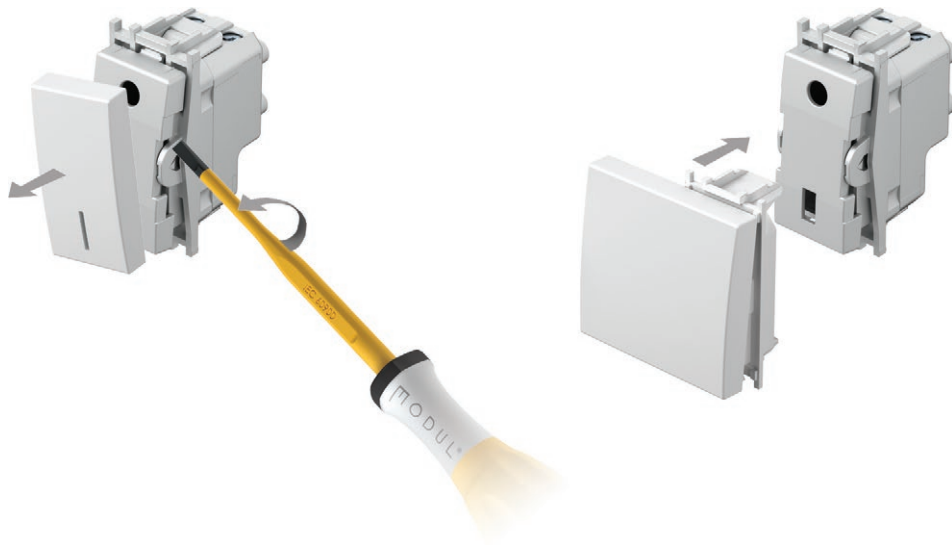

LASERSKO GRAVIRANJE NA TIPKAMA

- lasersko graviranje proizvodnje grafike na označenome mjestu
- standardni simboli dostupni sa skladišta, ostali na zahtjev

LASER PRINT ON BUTTONS

- laser print of any graphics on marked locations
- standard symbols from stock, other on request

1M

A
B
C

2M

A	D	G
B	E	H
C	F	I

SIMBOLI

SYMBOLS

01	02	03	04	05	06	07	08	09	10	11	12	20	21	22	23
24	25	26	27	28	29	30	31	32	33	34	35	36	37	38	39
					OFF	ON					AC				
40	41	42	43	44	45	46	47	48							

STANDARDNI SIMBOLI

STANDARD SYMBOLS

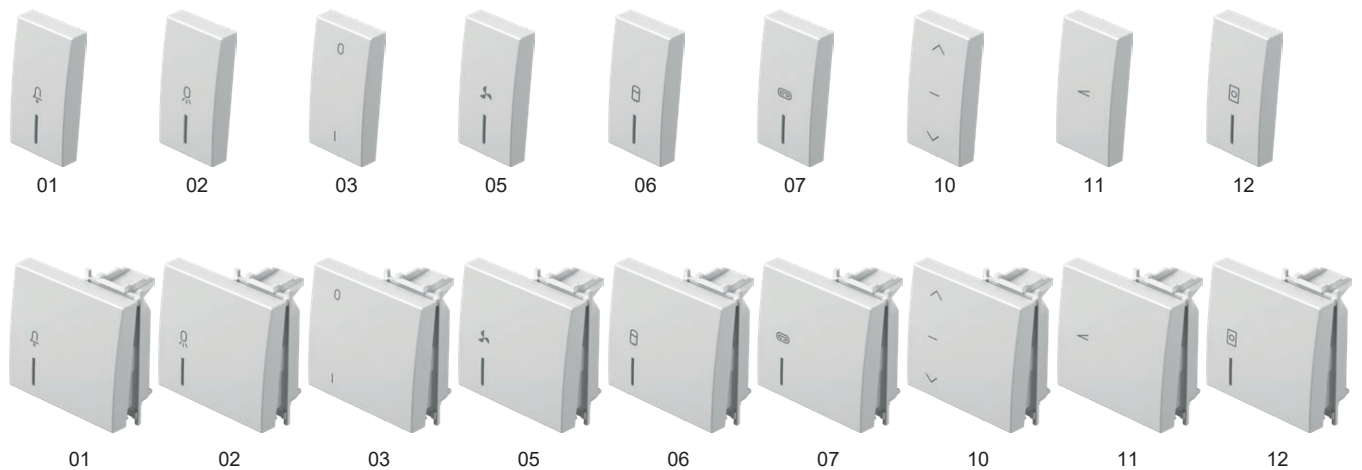

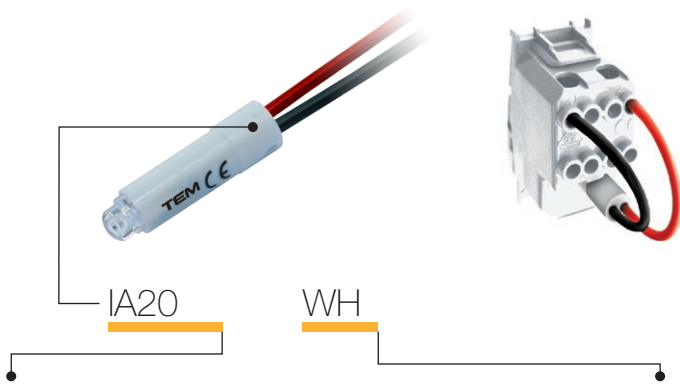

tip type	naziv description	tehnički podaci technical data	boja colour
IA10	NEONSKA TINJALICA NEON LAMP	230V~ 0,34W	<input type="checkbox"/> WH <i>bijela</i> <i>white</i>
IA20	LED TINJALICA LED LAMP	230V~ AC/DC 0,40W	<input checked="" type="checkbox"/> BL <i>plava</i> <i>blue</i>
IA21	LED TINJALICA LED LAMP	24V AC/DC 0,20W	<input checked="" type="checkbox"/> RD <i>crvena</i> <i>red</i>
·	·	·	<input checked="" type="checkbox"/> GR <i>zelena</i> <i>green</i>
·	·	·	<input checked="" type="checkbox"/> OR <i>narančasta</i> <i>orange</i>

NEONSKA TINJALICA 230V~ 0,34W

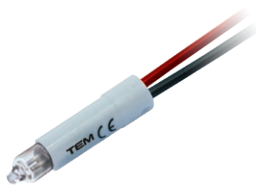

IA10OR

- za indicaciju, osvjettljenje ili stalno osvjettljenje sklopke
- u kombinaciji s tipkom s indikatorom

NEON LAMP 230V~ 0,34W

- for indication, illumination or constant illumination of switch
- in combination with button with indicator

LED TINJALICA 230V AC/DC 0,40W



IA20WH
 IA20GR
 IA20RD
 IA20BL

- za indicaciju, osvjettljenje ili stalno osvjettljenje sklopke
- u kombinaciji s tipkom s indikatorom

LED LAMP 230V AC/DC 0,40W

- for indication, illumination or constant illumination of switch
- in combination with button with indicator

LED TINJALICA 24V AC/DC 0,20W



IA21WH
 IA21RD

- za indicaciju, osvjettljenje ili stalno osvjettljenje sklopke
- u kombinaciji s tipkom s indikatorom

LED LAMP 24V AC/DC 0,20W

- for indication, illumination or constant illumination of switch
- in combination with button with indicator

LED TINJALICA 12V AC/DC 0,10W



IA22WH
 IA22RD

- za indicaciju, osvjettljenje ili stalno osvjettljenje sklopke
- u kombinaciji s tipkom s indikatorom

LED LAMP 12V AC/DC 0,10W

- for indication, illumination or constant illumination of switch
- in combination with button with indicator

RC SKLOP 250V~

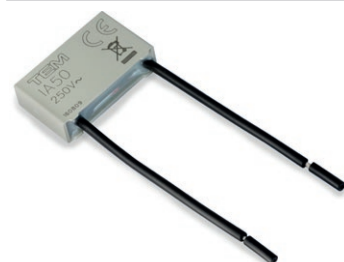

IA50

- RC sklop za uklanjanje smetnji pri radu LED svjetiljki
- moguće je usporedno povezati više RC sklopova sa svjetiljkama
- 0,1 µF, 100 Ω, 250V~

RC CIRCUIT 250V~

- RC circuit to eliminate disturbances in the operation of LED lamps
- parallel connections of more RC circuits with lamps are possible
- 0,1 µF, 100 Ω, 250V~

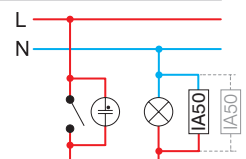

I L L U M I N A T I O N I A

* Indikacija /
Indication

Rasvjetna tijela /
Illumination

Stalno osvjetljenje /
Constant illumination

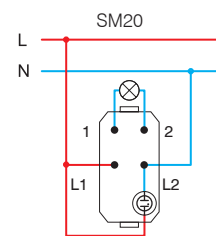
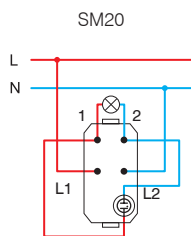
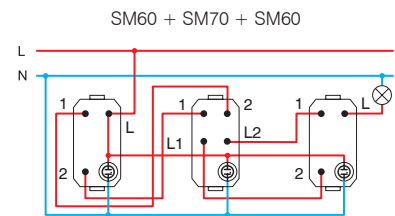
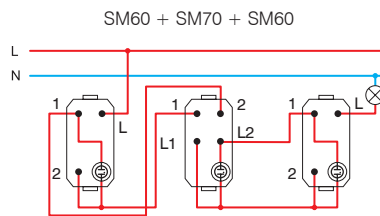
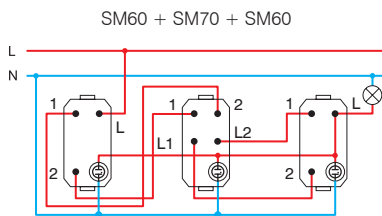
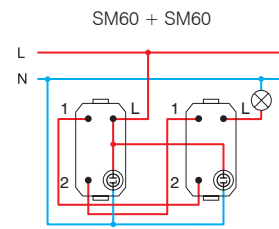
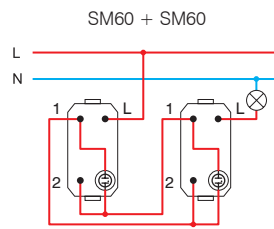
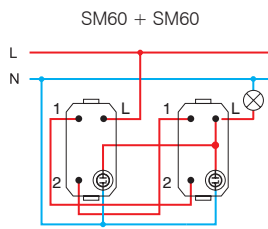
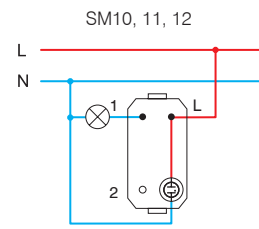
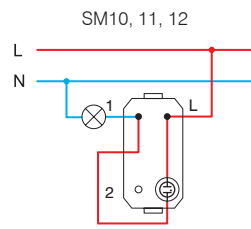
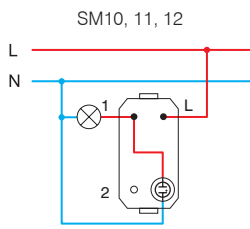

* spojne shema kompaktne fluorescentne tinjalice (CFL, LED) /
wiring scheme for energy saving lamps (CFL, LED)

1M = 22,5 x 45
2M = 45 x 45

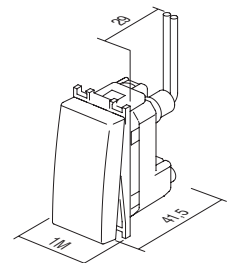

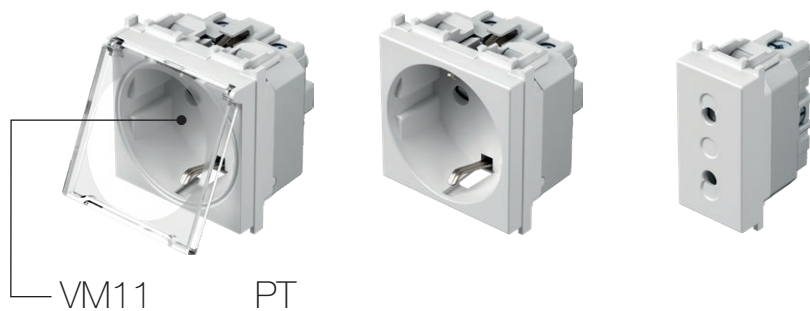

tip type	naziv description	tehnički podaci technical data	veličina size	boja colour																																				
VM10	UTIČNICA ŠUKO+KS SOCKET SCHUKO+KS	2P+E 16A 250V~	2M	<table border="0"> <tr> <td><input type="checkbox"/> PW</td> <td>bijela sjajna polar white</td> <td><input checked="" type="checkbox"/> PT</td> <td>bijela+prozirna white+transparent</td> <td><input type="checkbox"/> PP</td> <td>bijela+bijela white+white</td> </tr> </table>	<input type="checkbox"/> PW	bijela sjajna polar white	<input checked="" type="checkbox"/> PT	bijela+prozirna white+transparent	<input type="checkbox"/> PP	bijela+bijela white+white																														
<input type="checkbox"/> PW	bijela sjajna polar white	<input checked="" type="checkbox"/> PT	bijela+prozirna white+transparent	<input type="checkbox"/> PP	bijela+bijela white+white																																			
VM11	UTIČNICA ŠUKO+KS+POKLOPAC SOCKET SCHUKO+KS+COVER	2P+E 16A 250V~	2M	<table border="0"> <tr> <td><input checked="" type="checkbox"/> SB</td> <td>crna mat soft touch black</td> <td><input checked="" type="checkbox"/> BT</td> <td>crna+prozirna soft touch black+transparent</td> <td><input checked="" type="checkbox"/> BB</td> <td>crna+crna soft touch black+black</td> </tr> </table>	<input checked="" type="checkbox"/> SB	crna mat soft touch black	<input checked="" type="checkbox"/> BT	crna+prozirna soft touch black+transparent	<input checked="" type="checkbox"/> BB	crna+crna soft touch black+black																														
<input checked="" type="checkbox"/> SB	crna mat soft touch black	<input checked="" type="checkbox"/> BT	crna+prozirna soft touch black+transparent	<input checked="" type="checkbox"/> BB	crna+crna soft touch black+black																																			
VM20	UTIČNICA EURO+KS SOCKET EURO+KS	2P 10A 250V~	1M	<table border="0"> <tr> <td><input checked="" type="checkbox"/> AT</td> <td>antracit anthracite</td> <td><input checked="" type="checkbox"/> AT</td> <td>antracit+prozirna anthracite+transparent</td> <td><input checked="" type="checkbox"/> AA</td> <td>antracit+antracit anthracite+anthracite</td> </tr> <tr> <td><input type="checkbox"/> ES</td> <td>srebrna mat elox silver</td> <td><input checked="" type="checkbox"/> ST</td> <td>srebrna+prozirna silver+transparent</td> <td><input type="checkbox"/> SS</td> <td>srebrna+srebrna silver+silver</td> </tr> <tr> <td><input type="checkbox"/> IW</td> <td>bež sjajna ivory white</td> <td><input checked="" type="checkbox"/> IT</td> <td>bež+prozirna ivory+transparent</td> <td><input type="checkbox"/> II</td> <td>bež+bež ivory+ivory</td> </tr> <tr> <td><input checked="" type="checkbox"/> RD</td> <td>crvena red</td> <td><input checked="" type="checkbox"/> RT</td> <td>crvena+prozirna red+transparent</td> <td><input checked="" type="checkbox"/> RR</td> <td>crvena+crvena red+red</td> </tr> <tr> <td><input checked="" type="checkbox"/> GR</td> <td>zelen green</td> <td><input checked="" type="checkbox"/> GT</td> <td>zelen+prozirna green+transparent</td> <td><input checked="" type="checkbox"/> GG</td> <td>zelen+zelen green+green</td> </tr> <tr> <td><input checked="" type="checkbox"/> OR</td> <td>narančasta orange</td> <td><input checked="" type="checkbox"/> OT</td> <td>narančasta+prozirna orange+transparent</td> <td><input checked="" type="checkbox"/> OO</td> <td>narančasta+narančasta orange+orange</td> </tr> </table>	<input checked="" type="checkbox"/> AT	antracit anthracite	<input checked="" type="checkbox"/> AT	antracit+prozirna anthracite+transparent	<input checked="" type="checkbox"/> AA	antracit+antracit anthracite+anthracite	<input type="checkbox"/> ES	srebrna mat elox silver	<input checked="" type="checkbox"/> ST	srebrna+prozirna silver+transparent	<input type="checkbox"/> SS	srebrna+srebrna silver+silver	<input type="checkbox"/> IW	bež sjajna ivory white	<input checked="" type="checkbox"/> IT	bež+prozirna ivory+transparent	<input type="checkbox"/> II	bež+bež ivory+ivory	<input checked="" type="checkbox"/> RD	crvena red	<input checked="" type="checkbox"/> RT	crvena+prozirna red+transparent	<input checked="" type="checkbox"/> RR	crvena+crvena red+red	<input checked="" type="checkbox"/> GR	zelen green	<input checked="" type="checkbox"/> GT	zelen+prozirna green+transparent	<input checked="" type="checkbox"/> GG	zelen+zelen green+green	<input checked="" type="checkbox"/> OR	narančasta orange	<input checked="" type="checkbox"/> OT	narančasta+prozirna orange+transparent	<input checked="" type="checkbox"/> OO	narančasta+narančasta orange+orange
<input checked="" type="checkbox"/> AT	antracit anthracite	<input checked="" type="checkbox"/> AT	antracit+prozirna anthracite+transparent	<input checked="" type="checkbox"/> AA	antracit+antracit anthracite+anthracite																																			
<input type="checkbox"/> ES	srebrna mat elox silver	<input checked="" type="checkbox"/> ST	srebrna+prozirna silver+transparent	<input type="checkbox"/> SS	srebrna+srebrna silver+silver																																			
<input type="checkbox"/> IW	bež sjajna ivory white	<input checked="" type="checkbox"/> IT	bež+prozirna ivory+transparent	<input type="checkbox"/> II	bež+bež ivory+ivory																																			
<input checked="" type="checkbox"/> RD	crvena red	<input checked="" type="checkbox"/> RT	crvena+prozirna red+transparent	<input checked="" type="checkbox"/> RR	crvena+crvena red+red																																			
<input checked="" type="checkbox"/> GR	zelen green	<input checked="" type="checkbox"/> GT	zelen+prozirna green+transparent	<input checked="" type="checkbox"/> GG	zelen+zelen green+green																																			
<input checked="" type="checkbox"/> OR	narančasta orange	<input checked="" type="checkbox"/> OT	narančasta+prozirna orange+transparent	<input checked="" type="checkbox"/> OO	narančasta+narančasta orange+orange																																			



UTIČNICA ŠUKO+KS 2P+E 16A 250V~ 2M

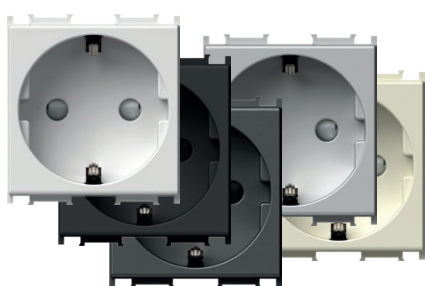

- VM10PW
- VM10SB
- VM10AT
- VM10ES
- VM10IW

- 2P+E šuko
- 16A 250V~, tip VM10
- sukladno normama IEC 60884-1, CEE7
- vijčano pričvršćivanje vodiča presjeka 1,5-2,5 mm²
- KS zaštita za djecu od dodira kontakta

SOCKET SCHUKO+KS 2P+E 16A 250V~ 2M

- 2P+E schuko
- 16A 250V~, type VM10
- in accordance with IEC 60884-1, CEE7
- screw contacts 1.5-2.5 mm²
- KS build-in child protection - shuttered live contacts



UTIČNICA ŠUKO+KS 2P+E 16A 250V~ 2M

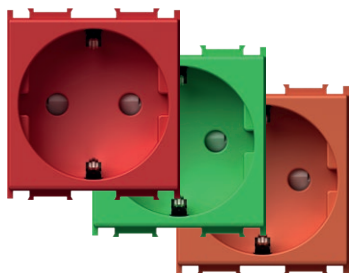

- VM10RD
- VM10GR
- VM10OR

- 2P+E šuko
- 16A 250V~, tip VM10
- sukladno normama IEC 60884-1, CEE7
- vijčano pričvršćivanje vodiča presjeka 1,5-2,5 mm²
- KS zaštita za djecu od dodira kontakta

SOCKET SCHUKO+KS 2P+E 16A 250V~ 2M

- 2P+E schuko
- 16A 250V~, type VM10
- in accordance with IEC 60884-1, CEE7
- screw contacts 1.5-2.5 mm²
- KS build-in child protection - shuttered live contacts



UTIČNICA ŠUKO+KS +POKLOPAC 2P+E 16A 250V~ 2M

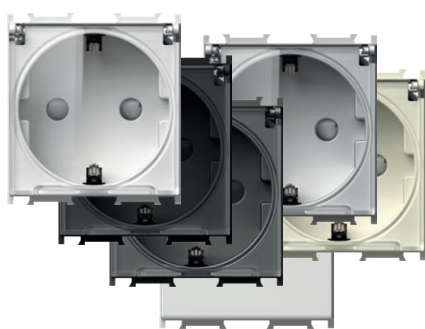

- VM11PT
- VM11BT
- VM11AT
- VM11ST
- VM11IT
- VM11PP

- 2P+E šuko + poklopac
- 16A 250V~, tip VM11
- sukladno normama IEC 60884-1, CEE7
- vijčano pričvršćivanje vodiča presjeka 1,5-2,5 mm²
- KS zaštita za djecu od dodira kontakta

SOCKET SCHUKO+KS+COVER
2P+E 16A 250V~ 2M

- 2P+E schuko+cover
- 16A 250V~, type VM11
- in accordance with IEC 60884-1, CEE7
- screw contacts 1.5-2.5 mm²
- KS build-in child protection - shuttered live contacts



UTIČNICA EURO+KS 2P 10A 250V~ 1M

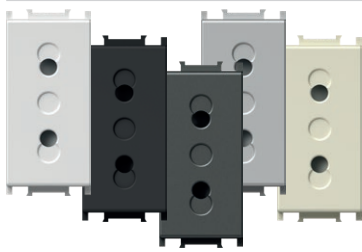

- VM20PW
- VM20SB
- VM20AT
- VM20ES
- VM20IW

- 2P Euro
- 10A 250V~, tip VM20
- sukladno normama IEC 60884-1, CEE7
- vijčano pričvršćivanje vodiča presjeka 1,5-2,5 mm²
- KS zaštita za djecu od dodira kontakta



SOCKET EURO+KS 2P 10A 250V~ 1M

- 2P Euro
- 10A 250V~, type VM20
- in accordance with IEC 60884-1, CEE7
- screw contacts 1.5-2.5 mm²
- KS build-in child protection - shuttered live contacts

UTIČNICA FRANCUSKA+KS 2P+E 16A 250V~ 2M

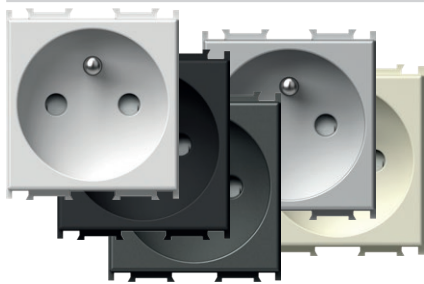

- VM40PW
- VM40SB
- VM40AT
- VM40ES
- VM40IW

- 2P+E francuska
- 16A 250V~, tip VM40
- sukladno normama IEC 60884-1, NF C 61-314 CEE7
- vijčano pričvršćivanje vodiča presjeka 1,5-2,5 mm²
- KS zaštita za djecu od dodira kontakta

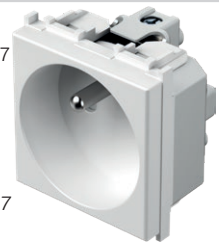

SOCKET FRENCH+KS 2P+E 16A 250V~ 2M

- 2P+E French
- 16A 250V~, type VM40
- in accordance with IEC 60884-1, NF C 61-314, CEE7
- screw contacts 1.5-2.5 mm²
- KS build-in child protection - shuttered live contacts

UTIČNICA FRANCUSKA+KS 2P+E 16A 250V~ 2M

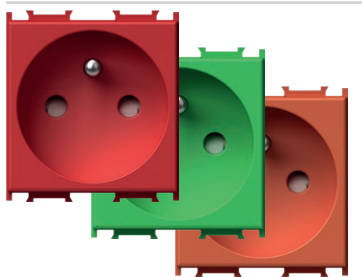

- VM40RD
- VM40GR
- VM40OR

- 2P+E francuska
- 16A 250V~, tip VM40
- sukladno normama IEC 60884-1, NF C 61-314 CEE7
- vijčano pričvršćivanje vodiča presjeka 1,5-2,5 mm²
- KS zaštita za djecu od dodira kontakta

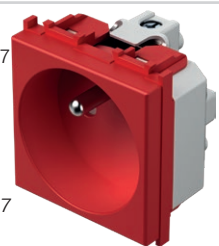

SOCKET FRENCH+KS 2P+E 16A 250V~ 2M

- 2P+E French
- 16A 250V~, type VM40
- in accordance with IEC 60884-1, NF C 61-314, CEE7
- screw contacts 1.5-2.5 mm²
- KS build-in child protection - shuttered live contacts

UTIČNICA FRANCUSKA+KS+POKLOPAC 2P+E 16A 250V~ 2M



- VM41PT
- VM41BT
- VM41AT
- VM41ST
- VM41IT

- 2P+E francuska+poklopac
- 16A 250V~, tip VM41
- sukladno normama IEC 60884-1, NF C 61-314 CEE7
- vijčano pričvršćivanje vodiča presjeka 1,5-2,5 mm²
- KS zaštita za djecu od dodira kontakta



SOCKET FRENCH+KS+COVER

- 2P+E 16A 250V~ 2M
- 2P+E French+cover
- 16A 250V~, type VM41
- in accordance with IEC 60884-1, NF C 61-314, CEE7
- screw contacts 1.5-2.5 mm²
- KS build-in child protection - shuttered live contacts

UTIČNICA TALIJANSKA P17/11+KS 2P+E 16A 250V~ 1M

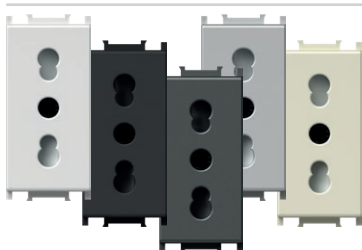

- VM30PW
- VM30SB
- VM30AT
- VM30ES
- VM30IW

- 2P+E talijanska P17/11
- 16A 250V~, tip VM30
- sukladno normama IEC 60884-1, CEI 23-50
- vijčano pričvršćivanje vodiča presjeka 1,5-2,5 mm²
- KS zaštita za djecu od dodira kontakta



SOCKET ITALIAN P17/11+KS 2P+E 16A 250V~ 1M

- 2P+E Italian P17/11
- 16A 250V~, type VM30
- in accordance with IEC 60884-1, CEI 23-50
- screw contacts 1.5-2.5 mm²
- KS build-in child protection - shuttered live contacts

UTIČNICA ŠUKO TALIJANSKA P17/11+KS 2P+E 16A 250V~ 2M

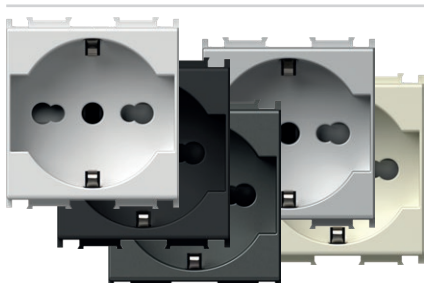

- VM31PW
- VM31SB
- VM31AT
- VM31ES
- VM31IW

- 2P+E šuko/talijanska P17/11
- 16A 250V~, tip VM31
- sukladno normama IEC 60884-1, CEI 23-50
- vijčano pričvršćivanje vodiča presjeka 1,5-2,5 mm²
- KS zaštita za djecu od dodira kontakta

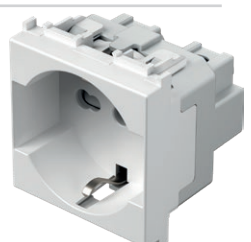

SOCKET SCHUKO/ITA P17/11+KS

- 2P+E 16A 250V~ 2M
- 2P+E schuko/italian P17/11
- 16A 250V~, type VM31
- in accordance with IEC 60884-1, CEI 23-50
- screw contacts 1.5-2.5 mm²
- KS build-in child protection - shuttered live contacts

UTIČNICA ŠUKO TALIJANSKA P30+KS 2P+E 16A 250V~ 2M

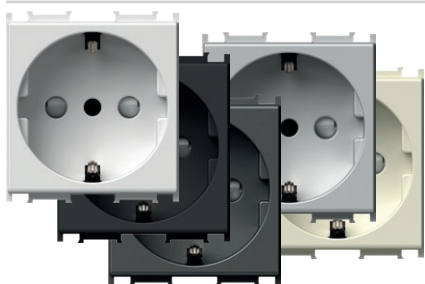

- VM32PW
- VM32SB
- VM32AT
- VM32ES
- VM32IW

- 2P+E šuko/talijanska P30
- 16A 250V[~], tip VM32
- sukladno normama IEC 60884-1, CEI 23-50
- vijčano pričvršćivanje vodiča presjeka 1,5-2,5 mm²
- KS zaštita za djecu od dodira kontakta



SOCKET SCHUKO/ITA P30+KS
2P+E 16A 250V~ 2M

- 2P+E schuko/italian P30
- 16A 250V[~], type VM32
- in accordance with IEC 60884-1, CEI 23-50
- screw contacts 1.5-2.5 mm²
- KS build-in child protection - shuttered live contacts

UTIČNICA TALIJANSKA P11+KS 2P+E 10A 250V~ 1M

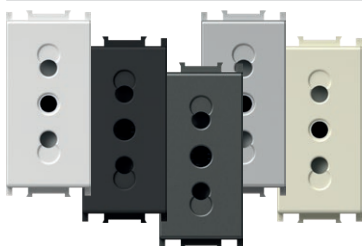

- VM33PW
- VM33SB
- VM33AT
- VM33ES
- VM33IW

- 2P+E talijanska P11
- 10A 250V[~], tip VM33
- sukladno normama IEC 60884-1, CEI 23-50
- vijčano pričvršćivanje vodiča presjeka 1,5-2,5 mm²
- KS zaštita za djecu od dodira kontakta



SOCKET ITALIAN P11+KS 2P+E 10A 250V~ 1M

- 2P+E Italian P11
- 10A 250V[~], type VM33
- in accordance with IEC 60884-1, CEI 23-50
- screw contacts 1.5-2.5 mm²
- KS build-in child protection - shuttered live contacts

UTIČNICA EURO/AMERIČKA+KS 2P 16A 250V~ 1M



- VM21PW
- VM21SB
- VM21AT
- VM21ES
- VM21IW

- 2P euro/američka
- 16A 250V[~], tip VM21
- vijčano pričvršćivanje vodiča presjeka 1,5-2,5 mm²
- KS zaštita za djecu od dodira kontakta
- samo za zemlje koje nisu članice EU-a



SOCKET EURO/AMERICAN+KS 2P 16A 250V~ 1M

- 2P Euro/American
- 16A 250V[~], type VM21
- screw contacts 1.5-2.5 mm²
- KS build-in child protection - shuttered live contacts
- only for countries not members of EU

UTIČNICA BRITANSKA BS 546+KS 2P+E 15A 250V~ 2M

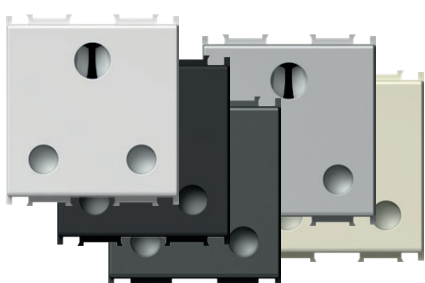

- VM51PW
- VM51SB
- VM51AT
- VM51ES
- VM51IW

- 2P+E britanska BS 546
- 15A 250V[~], tip VM51
- sukladno normi BS 546
- vijčano pričvršćivanje vodiča presjeka 1,5-4 mm²
- KS zaštita za djecu od dodira kontakta



SOCKET BRITISH BS 546+KS 2P+E 15A 250V~ 2M

- 2P+E British BS 546
- 15A 250V[~], type VM51
- in accordance with BS 546
- screw contacts 1.5-4 mm²
- KS build-in child protection - shuttered live contacts

UTIČNICA BRITANSKA BS 1363-2+KS 2P+E 13A 250V~ 2M

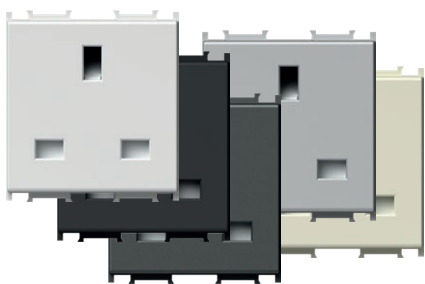

- VM52PW
- VM52SB
- VM52AT
- VM52ES
- VM52IW

- 2P+E britanska BS 1363-2
- 13A 250V[~], tip VM52
- sukladno normi BS 1363-2
- vijčano pričvršćivanje vodiča presjeka 1,5-4 mm²
- KS zaštita za djecu od dodira kontakta

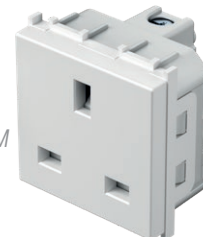

SOCKET BRITISH BS 1363-2+KS 2P+E 13A 250V~ 2M

- 2P+E British BS 1363-2
- 13A 250V[~], type VM52
- in accordance with BS 1363-2
- screw contacts 1.5-4 mm²
- KS build-in child protection - shuttered live contacts

PRENAPONSKA ZAŠTITA MPE MINI 275V/50Hz



VM80

- paralelni spoj s prvom utičnicom u nizu
- razred zaštite III
- Uc = 275Vac, Uoc/Isc = 6kV/3kA, Up < 800V
- sukladno normi IEC 61643-1
- vodiči presjeka 1,5 mm², IP20
- zvučni signal u slučaju proboja



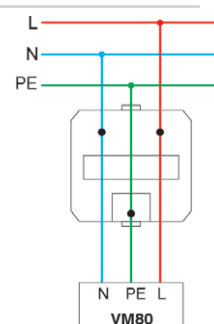

SURGE PROTECTOR MPE MINI 275V/50Hz

- parallel connection with the first socket in the row
- protection class III
- Uc = 275Vac, Uoc/Isc = 6kV/3kA, Up < 800V
- in accordance with IEC 61643-1
- wires 1.5mm², IP20
- sound signal at breakdown





S O C K E T S V M

POVEZIVANJE UTIČNICA I UTIKAČA SOCKETS AND PLUGS MATCHING

UTIČNICA / SOCKET	VM10 VM11	VM20	VM30	VM33	VM31	VM32	VM40 VM41	VM21
VRSTA UTIKAČA / PLUG STYLE								
Njemački / German 	•				•	•		
Francuski / French 	•				•	•	•	
Talijanski / Italian S11 			•	•	•	•		
Talijanski / Italian S17 			•	•	•			
euro 	•	•	•		•	•	•	•

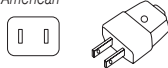
POVEZIVANJE UTIČNICA I UTIKAČA SOCKETS AND PLUGS MATCHING

UTIČNICA / SOCKET	VM21	VM51	VM52
VRSTA UTIKAČA / PLUG STYLE			
Američki / American 	•		
Britanski / British BS 546 		•	
Britanski / British BS 1363-2 			•

1M = 22,5 x 45
2M = 45 x 45

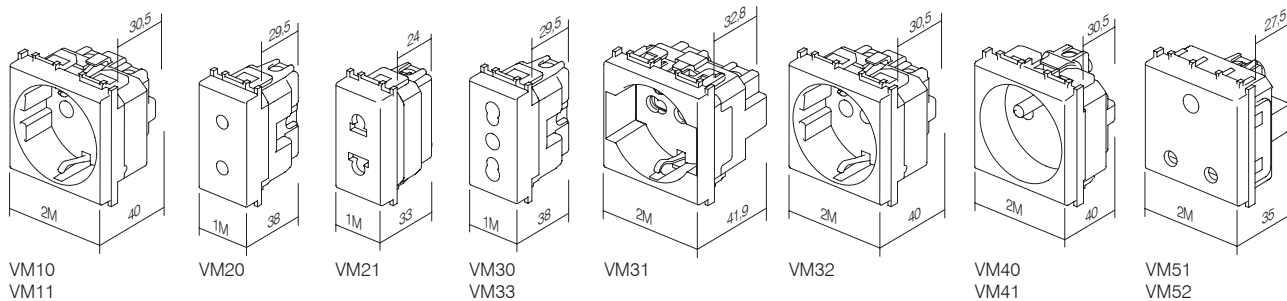

VM10
VM11

VM20

VM21

VM30
VM33

VM31

VM32

VM40
VM41

VM51
VM52



KM10

PW

tip type	naziv description	tehnički podaci technical data	veličina size	boja colour
KM10	UTIČNICA TV OSNOVNA SOCKET TV BASIC	0dB	1M	<input type="checkbox"/> PW bijela sjajna polar white
KM11	UTIČNICA TV ZAVRŠNA SOCKET TV END-LINE	1dB	1M	<input checked="" type="checkbox"/> SB crna mat soft touch black
KM12	UTIČNICA TV PROLAZNA SOCKET TV TROUGHPASS	10dB	1M	<input checked="" type="checkbox"/> AT anthracite
⋮	⋮	⋮	⋮	<input type="checkbox"/> ES srebrna mat elox silver
⋮	⋮	⋮	⋮	<input type="checkbox"/> IW bež sjajna ivory white

UTIČNICA TV OSNOVNA 0dB 1M

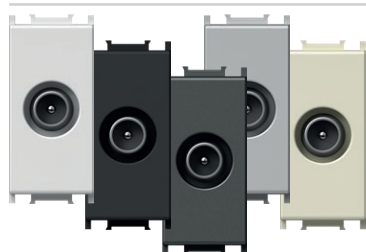

- KM10PW
- KM10SB
- KM10AT
- KM10ES
- KM10IW

- TV osnovna
 - prigušenje 0dB
 - stražnji konektor – F standard
- SOCKET TV BASIC 0dB 1M**
- TV basic
 - reduction 0dB
 - back connector – F standard



UTIČNICA TV OSNOVNA 0dB 2M

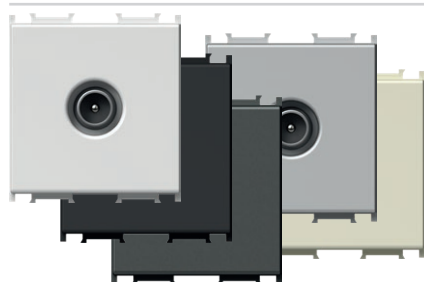

- KM20PW
- KM20SB
- KM20AT
- KM20ES
- KM20IW

- TV osnovna
 - prigušenje 0dB
 - stražnji konektor – F standard
- SOCKET TV BASIC 0dB 2M**
- TV basic
 - reduction 0dB
 - back connector – F standard



UTIČNICA TV ZAVRŠNA 1dB 1M

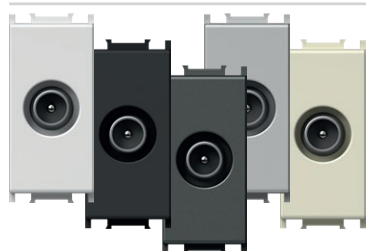

- KM11PW
- KM11SB
- KM11AT
- KM11ES
- KM11IW

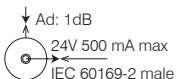

- TV završna
- propušta frekvenciju u rasponu 5÷2400 MHz
- prigušenje < 1 dB
- sukladno normi EN 50083-1
- vijčano pričvršćivanje vodiča

SOCKET TV END-LINE 1dB 1M

- TV end-line
- frequency range 5÷2400 MHz
- reduction < 1 dB
- in accordance with EN 50083-1
- screw contacts



UTIČNICA TV PROLAZNA 10dB 1M



- KM12PW
- KM12SB
- KM12AT
- KM12ES
- KM12IW

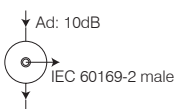

- TV prolazna
- propušta frekvenciju u rasponu 5÷2400 MHz
- prigušenje < 10 dB
- sukladno normi EN 50083-1
- vijčano pričvršćivanje vodiča

SOCKET TV TROUGHPASS 10dB 1M

- TV troughpass
- frequency range 5÷2400 MHz
- reduction < 10 dB
- in accordance with EN 50083-1
- screw contacts



UTIČNICA SAT OSNOVNA 0dB 1M



- KM15PW
- KM15SB
- KM15AT
- KM15ES
- KM15IW

- SAT osnovna
- prigušenje 0dB
- stražnji konektor – F standard

SOCKET SAT BASIC 0dB 1M

- SAT basic
- reduction 0dB
- back connector – F standard



UTIČNICA SAT OSNOVNA 0dB 2M

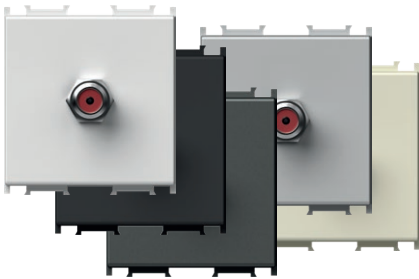

- KM24PW
- KM24SB
- KM24AT
- KM24ES
- KM24IW

- SAT osnovna
- prigušenje 0dB
- stražnji konektor – F standard

SOCKET SAT BASIC 0dB 2M

- SAT basic
- reduction 0dB
- back connector – F standard



UTIČNICA SAT ZAVRŠNA 1dB 1M



- KM16PW
- KM16SB
- KM16AT
- KM16ES
- KM16IW

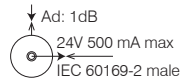

- SAT završna
- propušta frekvenciju u rasponu 5÷2400 MHz
- prigušenje < 1dB
- sukladno normi EN 50083-1
- vijčano pričvršćivanje vodiča

SOCKET SAT END-LINE 1dB 1M

- SAT end-line
- frequency range 5÷2400 MHz
- reduction < 1dB
- in accordance with EN 50083-1
- screw contacts



UTIČNICA R OSNOVNA 0dB 1M



- KM19PW
- KM19SB
- KM19AT
- KM19ES
- KM19IW

- R OSNOVNA
- prigušenje 0dB
- stražnji konektor – F standard

SOCKET R BASIC 0dB 1M

- R basic
- reduction 0dB
- back connector – F standard



UTIČNICA R OSNOVNA 0dB 2M

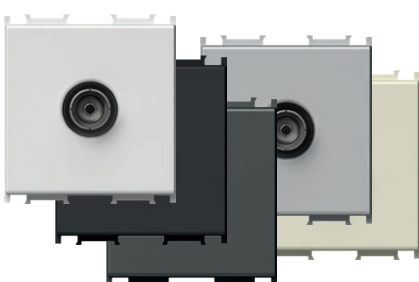

- KM29PW
- KM29SB
- KM29AT
- KM29ES
- KM29IW

- R osnovna
- prigušenje 0dB
- stražnji konektor – F standard

SOCKET R BASIC 0dB 2M

- R basic
- reduction 0dB
- back connector – F standard



UTIČNICA SAT-TV ZAVRŠNA 1dB 2M

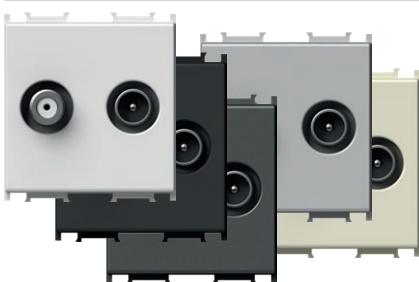

- KM25PW
- KM25SB
- KM25AT
- KM25ES
- KM25IW

- SAT-TV završna
- propušta frekvenciju u rasponu 5÷2400 MHz
- prigušenje < 1dB
- sukladno normi EN 50083-1
- vijčano pričvršćivanje vodiča

SOCKET SAT-TV END-LINE 1dB 2M

- SAT-TV end-line
- frequency range 5÷2400 MHz
- reduction < 1dB
- in accordance with EN 50083-1
- screw contacts

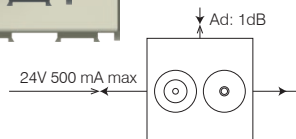

PRIMJERI OSNOVNOG SPOJA
BASIC CONNECTION SAMPLES

pojedinačni spoj
stand alone connection

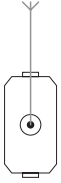

KM10
KM20
KM11
KM15
KM24
KM16
KM19
KM29
KM25

zvjezdasti spoj
star connection

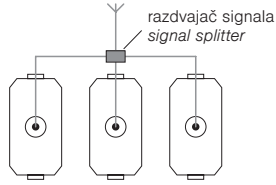

KM10
KM20
KM11
KM15
KM24
KM16
KM19
KM29
KM25

prolazni spoj
throughpass connection

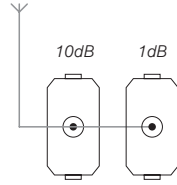

KM12 KM11



- KM22PW
- KM22SB
- KM22AT
- KM22ES
- KM22IW

UTIČNICA AUDIO 2xRCA 1M

- audio 2x RCA
- lemljenje spojeva kabela na stražnjoj strani

SOCKET AUDIO 2xRCA 1M

- audio 2x RCA
- soldering connection of cable at the back side



- KM23PW
- KM23SB
- KM23AT
- KM23ES
- KM23IW

UTIČNICA AUDIO ZVUČNICI 1M

- audio 2x Ø4 mm
- pričvršćivanje vodiča za zvučnike umetanjem ili banana utikačem Ø4 mm
- lemljenje spojeva kabela na stražnjoj strani

SOCKET AUDIO LOUDSPEAKERS 1M

- audio 2x Ø4mm
- to accommodate speaker wire, banana plug Ø4mm or spades
- soldering connection of cable at the back side



- KM26PW
- KM26SB
- KM26AT
- KM26ES
- KM26IW

UTIČNICA AUDIO ZVUČNICI 2M

- audio 2x Ø4 mm
- pričvršćivanje vodiča za zvučnike umetanjem ili banana utikačem Ø4 mm
- lemljenje spojeva kabela na stražnjoj strani

SOCKET AUDIO LOUDSPEAKERS 2M

- audio 2x Ø4mm
- to accommodate speaker wire, banana plug Ø4mm or spades
- soldering connection of cable at the back side



1M = 22,5 x 45
2M = 45 x 45

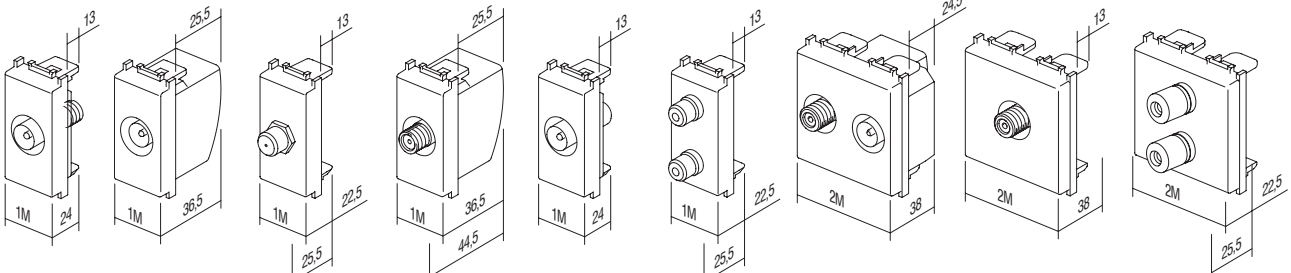

KM10

KM11
KM12

KM15

KM16

KM19

KM22
KM23

KM25

KM20
KM24
KM29

KM26

UTIČNICA TEL LT RJ11 6/4 1M



- KM30PW
- KM30SB
- KM30AT
- KM30ES
- KM30IW

- TEL LT vijak
- RJ11 6/4
- sukladno normi IEC 60603-7
- vijčano pričvršćivanje

SOCKET TEL LT RJ11 6/4 1M

- TEL LT screw
- RJ11 6/4
- in accordance with IEC 60603-7
- screw contacts



UTIČNICA TEL BT SEC 6/6 1M

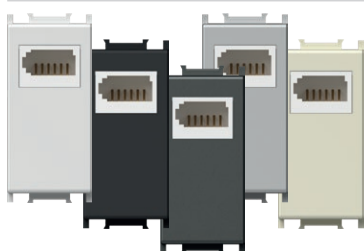

- KM31PW
- KM31SB
- KM31AT
- KM31ES
- KM31IW

- TEL BT britanski standard
- SEC sekundarna 6/6
- sukladno normi BS 6312
- vijčano pričvršćivanje

SOCKET TEL BT SEC 6/6 1M

- TEL BT British standard
- SEC secondary 6/6
- in accordance with BS 6312
- screw contacts



UTIČNICA TEL KS RJ11 6/4 1M

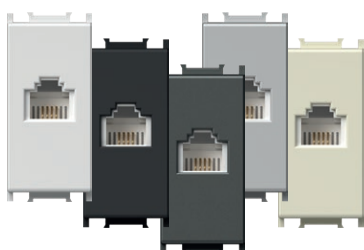

- KM36PW
- KM36SB
- KM36AT
- KM36ES
- KM36IW

- KS keystone standard pričvršćivanja
- RJ11 6/4
- sukladno normi IEC 60603-7

SOCKET TEL KS RJ11 6/4 1M

- KS keystone fixing standard
- RJ11 6/4
- in accordance with IEC 60603-7

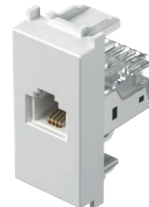

UTIČNICA CAT5e KS RJ45 8/8 1M

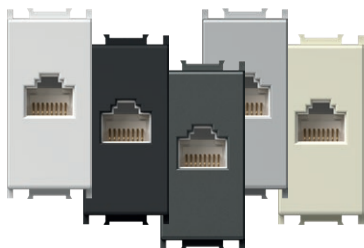

- KM37PW
- KM37SB
- KM37AT
- KM37ES
- KM37IW

- KS keystone standard pričvršćivanja
- CAT5e, RJ45 8/8
- sukladno normi IEC 60603-7

SOCKET CAT5e KS RJ45 8/8 1M

- KS keystone fixing standard
- CAT5e, RJ45 8/8
- in accordance with IEC 60603-7



ADAPTER KS 1M

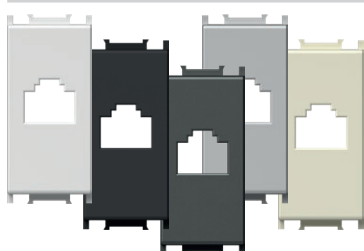

- KM35PW
- KM35SB
- KM35AT
- KM35ES
- KM35IW

- KS keystone standard pričvršćivanja
- AMP, Avaya, Brandrex, FMT, Mfico, Tyco, ...
- nije ugrađen komunikacijski modul

ADAPTER KS 1M

- KS keystone fixing standard
- AMP, Avaya, Brandrex, FMT, Mfico, Tyco, ...
- communication module not included



ADAPTER KS SA ZAŠTITOM OD PRAŠINE 1M



- KM38PW
- KM38SB
- KM38AT
- KM38ES
- KM38IW

- KS keystone standard pričvršćivanja sa zaštitom od prašine
- AMP, Avaya, Brandrex, FMT, Mfico, Tyco, ...
- nije ugrađen komunikacijski modul

ADAPTER KS WITH DUST PROTECTION 1M

- KS keystone fixing standard with dust protection
- AMP, Avaya, Brandrex, FMT, Mfico, Tyco, ...
- communication module not included



UTIČNICA CAT6 SCH KS RJ45 8/8 1M

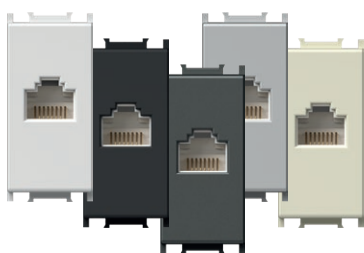

- KM39PW
- KM39SB
- KM39AT
- KM39ES
- KM39IW

- KS keystone standard pričvršćivanja
- CAT6 UTP toolless, RJ45 8/8
- odgovara ISO/IEC 11801

SOCKET CAT6 SCH KS RJ45 8/8 1M

- KS keystone fixing standard
- CAT6 UTP toolless, RJ45 8/8
- in accordance with ISO/IEC 11801



ADAPTER KS UNIVERZALNI 1M

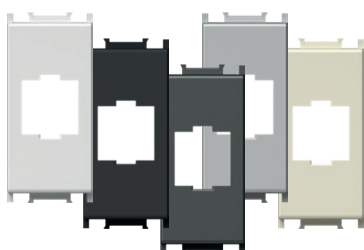

- KM50PW
- KM50SB
- KM50AT
- KM50ES
- KM50IW

- KS keystone standard pričvršćivanja
- prikladan za HDMI, USB
- nije ugrađen komunikacijski modul

ADAPTER KS UNIVERSAL 1M

- KS keystone fixing standard
- suitable for HDMI, USB
- communication module not included



ADAPTER PD 1M

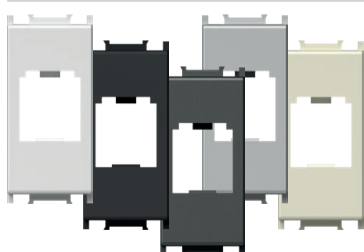

- KM40PW
- KM40SB
- KM40AT
- KM40ES
- KM40IW

- PD Panduit Mini-COM standard pričvršćivanja
- nije ugrađen komunikacijski modul

ADAPTER PD 1M

- PD Panduit Mini-COM fixing standard
- communication module not included

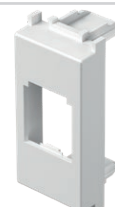

ADAPTER PD SA ZAŠTITOM OD PRAŠINE 1M



- KM43PW
- KM43SB
- KM43AT
- KM43ES
- KM43IW

- PD Panduit Mini-COM standard pričvršćivanja sa zaštitom od prašine
- nije ugrađen komunikacijski modul

ADAPTER PD WITH DUST PROTECTION 1M

- PD Panduit Mini-COM fixing standard with dust protection
- communication module not included



ADAPTER R&M 1M

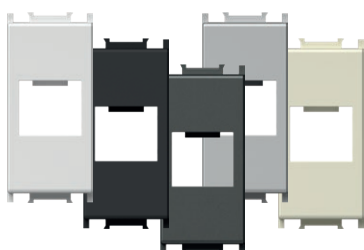

- KM46PW
- KM46SB
- KM46AT
- KM46ES
- KM46IW

- R&M standard pričvršćivanja
- nije ugrađen komunikacijski modul

ADAPTER R&M 1M

- R&M fixing standard
- communication module not included



ADAPTER R&M CAT6A 1M

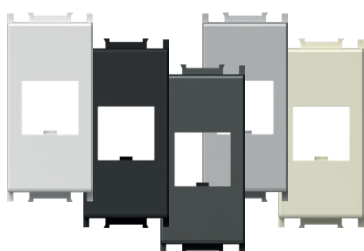

- KM52PW
- KM52SB
- KM52AT
- KM52ES
- KM52IW

- R&M montaža za CAT6A
- nije ugrađen komunikacijski modul

ADAPTER R&M CAT6A 1M

- R&M fixing for CAT6A
- communication module not included



ADAPTER R&M SA ZAŠTITOM OD PRAŠINE 1M



- KM47PW
- KM47SB
- KM47AT
- KM47ES
- KM47IW

- R&M standard pričvršćivanja sa zaštitom protiv prašine
- nije ugrađen komunikacijski modul

ADAPTER R&M WITH DUST PROTECTION 1M

- R&M fixing standard with dust protection
- communication module not included



ADAPTER R&M CAT6A SA ZAŠTITOM OD PRAŠINE 1M



- KM53PW
- KM53SB
- KM53AT
- KM53ES
- KM53IW

- R&M montaža za CAT6A s poklopcem za zaštitu od prašine
- nije ugrađen komunikacijski modul

ADAPTER R&M CAT6A WITH DUST PROTECTION 1M

- R&M fixing for CAT6A with dust protection
- communication module not included



ADAPTER LK 1M

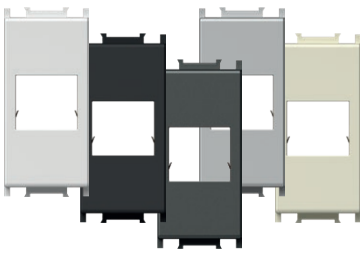

- KM45PW
- KM45SB
- KM45AT
- KM45ES
- KM45IW

- LK LeoniKerpen eLine / BKS NewLine standard pričvršćivanja
- nije uključen komunikacijski modul

ADAPTER LK 1M

- LK LeoniKerpen eLine / BKS NewLine fixing standard
- communication module not included



ADAPTER NEXANS/SCHRACK 2M

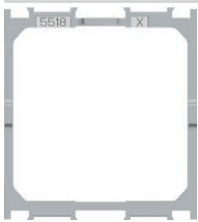

KA26

- pričvršćivanje adaptera za Nexans LANmark i module Schrack 45x45mm
- prikladno za tip Nexan N423.540N
- prikladno za tip Schrack HSEMD02W2F
- nije ugrađen komunikacijski modul

ADAPTER NEXANS/SCHRACK 2M

- fixing adapter for Nexans LANmark and Schrack module 45x45mm
- suitable for Nexans type N423.540N
- suitable for Schrack type HSEMD02W2F
- communication module not included

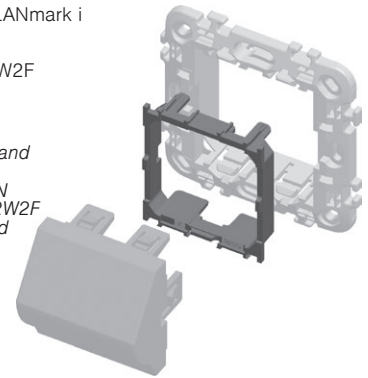

ADAPTER AT&T SYSTIMAX SA ZAŠTITOM OD PRAŠINE 1M



- KM48PW
- KM48SB
- KM48AT
- KM48ES
- KM48IW

- AT&T Systimax standard pričvršćivanja sa zaštitom od prašine
- nije ugrađen komunikacijski modul

ADAPTER AT&T SYSTIMAX WITH DUST PROTECTION 1M

- AT&T Systimax fixing standard with dust protection
- communication module not included



UTIČNICA USB TIP A 1M



- KM51PW
- KM51SB
- KM51AT
- KM51ES
- KM51IW

- USB 2.0 utičnica tip A
- vijčano pričvršćivanje, raster 5 mm, 1,5 mm², 1x2P + 1x3P
- spajanje:
PIN 1 – VCC (+5V, crvena žica)
PIN 2 – Data - (bijela žica)
PIN 3 – Data + (zeleno žica)
PIN 4 – GND - uzemljenje (crna žica)
S – zaštita
- sukladno direktivi 2011/95/EU (RoHS2)

SOCKET USB TYPE A 1M

- USB 2.0 socket type A
- screw contacts, raster 5 mm, 1,5 mm², 1x2P + 1x3P
- wiring:
PIN 1 – VCC (+5V, red wire)
PIN 2 – Data - (white wire)
PIN 3 – Data + (green wire)
PIN 4 – GND - ground (black wire)
S – shield
- in accordance with directive 2011/95/EU (RoHS2)



1M = 22,5 x 45
2M = 45 x 45

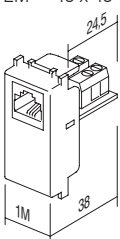

KM30

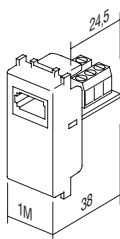

KM31

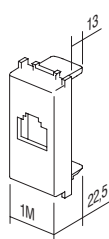

KM35
KM38
KM48

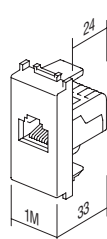

KM36
KM37
KM39

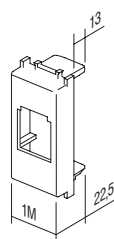

KM40
KM43

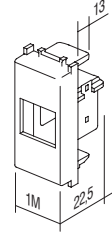

KM45

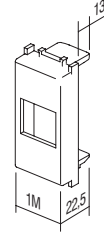

KM46
KM47
KM50
KM52
KM53

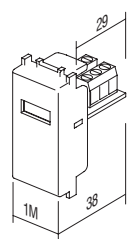

KM51

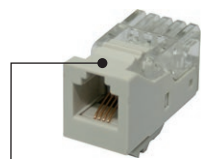

KA10

tip type	naziv description	tehnički podaci technical data
KA10	KONEKTOR KS CAT3 CONNECTOR KS CAT3	RJ11 6/4
KA11	KONEKTOR KS CAT5e CONNECTOR KS CAT5e	RJ45 8/8
KA12	KONEKTOR KS CAT5eS CONNECTOR KS CAT5eS	RJ45 8/8
⋮	⋮	⋮
⋮	⋮	⋮

KONEKTOR KS CAT3 RJ11 6/4



KA10

- KS keystone standard pričvrščivanja
- CAT3, RJ11 6/4
- skladno normi IEC 60603-7

CONNECTOR KS CAT3 RJ11 6/4

- KS keystone fixing standard
- CAT3, RJ11 6/4
- in accordance with IEC 60603-7

KONEKTOR KS CAT5e RJ45 8/8



KA11

- KS keystone standard pričvrščivanja
- CAT5e, RJ45 8/8
- skladno normi IEC 60603-7

CONNECTOR KS CAT5e RJ45 8/8

- KS keystone fixing standard
- CAT5e, RJ45 8/8
- in accordance with IEC 60603-7

KONEKTOR KS CAT5eS RJ45 8/8



KA12

- KS keystone standard pričvrščivanja
- CAT5eS, RJ45 8/8
- skladno normi IEC 60603-7

CONNECTOR KS CAT5eS RJ45 8/8

- KS keystone fixing standard
- CAT5eS, RJ45 8/8
- in accordance with IEC 60603-7

KONEKTOR KS CAT6 SCH RJ45 8/8



KA15

- KS keystone standard pričvrščivanja
- CAT6 UTP bezalatna montaža, RJ45 8/8
- skladno normi ISO/IEC 11801

CONNECTOR KS CAT6 SCH RJ45 8/8

- KS keystone fixing standard
- CAT6 UTP toolless, RJ45 8/8
- in accordance with ISO/IEC 11801

KONEKTOR KS CAT6S SCH RJ45 8/8



KA16

- KS keystone standard pričvrščivanja
- CAT6S STP bezalatna montaža, RJ45 8/8
- skladno normi ISO/IEC 11801

CONNECTOR KS CAT6S SCH RJ45 8/8

- KS keystone fixing standard
- CAT6S STP toolless, RJ45 8/8
- in accordance with ISO/IEC 11801

KONEKTOR KS CAT6a SCH RJ45 8/8

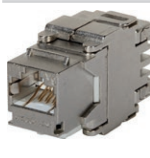

KA17

- KS keystone standard pričvrščivanja
- CAT6a STP bezalatna montaža, RJ45 8/8
- skladno normi ISO/IEC 11801

CONNECTOR KS CAT6a SCH RJ45 8/8

- KS keystone fixing standard
- CAT6a STP toolless, RJ45 8/8
- in accordance with ISO/IEC 11801



KA18

KONEKTOR TANKI KS CAT6S SCH RJ45 8/8

- KS keystone standard pričvrščivanja
- tanki dizajn
- CAT6S STP bezalatna montaža, RJ45 8/8
- skladno normi ISO/IEC 11801
- prikladno i s KE46 dvostrukim adapterom

CONNECTOR SLIM KS CAT6S SCH RJ45 8/8

- KS keystone fixing standard
- slim style
- CAT6S STP toolless, RJ45 8/8
- in accordance with ISO/IEC 11801
- suitable also for KE46 double adapter



KA27

KONEKTOR KS HDMI

- KS keystone standard pričvrščivanja
- samo u kombinaciji s adapterom KM50
- HDMI/HDMI

CONNECTOR KS HDMI

- KS keystone fixing standard
- only in combination with adapter KM50
- HDMI/HDMI



KA28

KABEL KS HDMI

- KS keystone standard pričvrščivanja
- samo u kombinaciji s adapterom KM50
- HDMI/HDMI

CABLE KS HDMI

- KS keystone fixing standard
- only in combination with adapter KM50
- HDMI/HDMI



EM31

PW

tip type	naziv description	tehnički podaci technical data	veličina size	boja colour
EM10	REGULATOR OSVJETLJENJA ROTACIJSKIR 300W <i>DIMMER ROTATIVE</i>		1M	<input type="checkbox"/> PW bijela sjajna <i>polar white</i>
EM12	REGULATOR OSVJETLJENJA ROTACIJSKI IZMJENIČNRL 300W <i>DIMMER ROTATIVE 2WAY</i>		1M	<input type="checkbox"/> SB crna mat <i>soft touch black</i>
EM23	REGULATOR OSVJETLJENJA UGRADNI RC,RL 200VA <i>DIMMER INBOX</i>		/	<input type="checkbox"/> AT antracit <i>anthracite</i>
·	·	·	·	<input type="checkbox"/> ES srebrna mat <i>elox silver</i>
·	·	·	·	<input type="checkbox"/> IW bež sjajna <i>ivory white</i>
·	·	·	·	<input type="checkbox"/> BL plava <i>blue</i>
·	·	·	·	<input type="checkbox"/> RD crvena <i>red</i>
·	·	·	·	<input type="checkbox"/> GR zelena <i>green</i>
·	·	·	·	<input type="checkbox"/> OR narančasta <i>orange</i>
·	·	·	·	<input type="checkbox"/> RG crveno-zelena <i>red/green</i>

REGULATOR OSVJETLJENJA ROTACIJSKI R 300W 1M



- EM10PW
- EM10SB
- EM10AT
- EM10ES
- EM10IW

- rotacijski bez sklopke
- tip RTS34, 43 RVP, opterećenje R, 40W – 300W
- mrežni napon 230V ~ 50Hz
- nije moguća kombinacija s izmjeničnom sklopkom
- povezivanje više regulatora osvjetljenja nije dopušteno
- sukladno normi EN 60669-1
- vijčano pričvršćivanje vodiča presjeka 1,5-2,5mm²
- LED indikacija



DIMMER ROTATIVE R 300W 1M

- rotation control without switch
- type RTS34, 43 RVP, load R, 40W - 300W
- supply voltage 230V ~ 50Hz
- 2-way switch combination is not possible
- more dimmers combination is not allowed
- in accordance with EN 60669-1
- screw contacts 1.5-2.5mm²
- LED indication

REGULATOR OSVJETLJENJA ROTACIJSKI IZMJENIČNI RL 300W 1M



- EM12PW
- EM12SB
- EM12AT
- EM12ES
- EM12IW

- rotacijski s izmjeničnom sklopkom
- opterećenje RL, 40 W – 300 W
- napajanje 230 V ~ 50 Hz
- moguća je kombinacija s izmjeničnom sklopkom
- zajedničko montiranje više uređaja u jednu dozu dopušteno je isključivo pod uvjetom da njihovo ukupno maksimalno opterećenje ne premašuje maksimalnu snagu jedne sklopke za zatamnjivanje
- dopušteno je korištenje samo jedne sklopke za zatamnjivanje po strujnom krugu
- osigurač nije montiran – morate upotrijebiti vanjski osigurač
- sukladno normi EN 60669-1
- vijčano pričvršćivanje vodiča presjeka 1,5 – 2,5 mm²
- integrirana LED rasvjeta označava razinu zatamnjivanja



DIMMER ROTATIVE/2WAY RL 300W 1M

- rotation control with 2-way switch
- load RL, 40W - 300W
- supply voltage 230V ~ 50Hz
- 2-way switch combination is possible
- installing several devices together in one box is only permitted if their total maximum load does not exceed the maximum power of a single dimmer
- one circuit allows the use of only one dimmer
- no built-in fuse – external fuse must be used
- in accordance with EN 60669-1
- screw contacts - 1.5-2.5mm²
- integrated LED indication of dimming level

REGULATOR OSVJETLJENJA ROTACIJSKI IZMJENIČNI LED 60W 1M



- EM13PW
- EM13SB
- EM13AT
- EM13ES
- EM13IW

- rotacijski s izmjeničnom sklopkom
- opterećenje:
 - LED, 0 – 60 W (maks. 6 LED tinjalica s regulacijom osvjetljenja)
 - GLS, 0 – 60 W
- napajanje 230 V \sim 50 Hz
- moguća je kombinacija s izmjeničnom sklopkom
- zajedničko montiranje više uređaja u jednu dozu dopušteno je isključivo pod uvjetom da njihovo ukupno maksimalno opterećenje ne premašuje maksimalnu snagu jedne sklopke za zatamnjene
- dopušteno je korištenje samo jedne sklopke za zatamnjene po strujnom krugu
- osigurač nije montiran – morate upotrijebiti vanjski osigurač
- sukladno normi IEC60669-2-1
- vijčano pričvršćivanje vodiča presjeka 1,5 – 2,5 mm²



DIMMER ROTATIVE/2WAY LED 60W 1M

- rotation control with 2-way switch
- loads: LED, 0 – 60W (max. 6 dimmable LED lamps)
- GLS, 0 – 60W
- supply voltage 230V \sim 50Hz
- 2-way switch combination is possible
- installing several devices together in one box is only permitted if their total maximum load does not exceed the maximum power of a single dimmer
- one circuit allows the use of only one dimmer
- no built-in fuse – external fuse must be used
- in accordance with IEC60669-2-1
- screw contacts - 1.5-2.5mm²

REGULATOR OSVJETLJENJA ROTACIJSKI IZMJENIČNI LED 180W 1M



- EM14PW
- EM14SB
- EM14AT
- EM14ES
- EM14IW

- rotacijski s izmjeničnom sklopkom
- opterećenje:
 - LED, 0 – 180 W (maks. 20 LED tinjalica s regulacijom osvjetljenja)
 - GLS, 0 – 180 W
- napajanje 230 V \sim 50 Hz
- moguća je kombinacija s izmjeničnom sklopkom
- zajedničko montiranje više uređaja u jednu dozu dopušteno je isključivo pod uvjetom da njihovo ukupno maksimalno opterećenje ne premašuje maksimalnu snagu jedne sklopke za zatamnjene
- dopušteno je korištenje samo jedne sklopke za zatamnjene po strujnom krugu
- osigurač nije montiran – morate upotrijebiti vanjski osigurač
- sukladno normi IEC60669-2-1
- vijčano pričvršćivanje vodiča presjeka 1,5 – 2,5 mm²

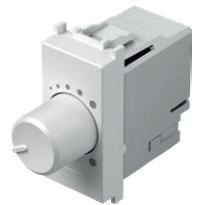

DIMMER ROTATIVE/2WAY LED 180W 1M

- rotation control with 2-way switch
- loads:
 - LED, 0 – 180W (max. 20 dimmable LED lamps)
 - GLS, 0 – 180W
- supply voltage 230V \sim 50Hz
- 2-way switch combination is possible
- installing several devices together in one box is only permitted if their total maximum load does not exceed the maximum power of a single dimmer
- one circuit allows the use of only one dimmer
- no built-in fuse – external fuse must be used
- in accordance with IEC60669-2-1
- screw contacts - 1.5-2.5mm²

REGULATOR OSVJETLJENJA ROTACIJSKI R 250W 1M



- EM15PW
- EM15SB
- EM15AT
- EM15ES
- EM15IW

- rotacijski bez sklopke
- tip RTS34, 43 RVP, opterećenje R, 40W – 250W
- mrežni napon 230V \sim 50Hz
- nije moguća kombinacija s izmjeničnom sklopkom
- povezivanje više regulatora osvjetljenja nije dopušteno
- sukladno normi EN 60669-1
- vijčano pričvršćivanje vodiča presjeka 1,5-2,5mm²
- LED indikacija



DIMMER ROTATIVE R 250W 1M

- rotation control without switch
- type RTS34, 43 RVP, load R, 40W - 250W
- supply voltage 230V \sim 50Hz
- 2-way switch combination is not possible
- more dimmers combination is not allowed
- in accordance with EN 60669-1
- screw contacts 1.5-2.5mm²
- LED indication

UGRADBENI ZATAMNJIVAČ R (250 W), (RC,RL 200VA)



EM23

- ugradbeni, za povezivanje s tipkalom
- opterećenje RLC 15-250W ili 15-200 VA
- napajanje 230 V[~] 50HZ
- moguće povezivanje više tipkala
- nije dopušteno povezivanje više tipkala
- ugrađena memorijska funkcija
- funkcija mekog uključivanja/isključivanja
- »leading edge«
- kompatibilan s EN60669, EN60950, EN 61000, ETSI EN 300 220-1, ETSI EN 300 220-2
- vijčana montaža vodiča do presjeka 2,5 mm²

DIMMER INBOX R (250 W), (RC, RL 200 VA)

- *inbox, controlled by external push button*
- *load RLC 15-250W or 15-200 VA*
- *supply voltage 230V[~] 50HZ*
- *several push-buttons combinations are possible*
- *more dimmers combination is not allowed*
- *light intensity memory*
- *soft start/stop function*
- *»leading edge«*
- *in accordance with EN60669, EN60950, EN 61000, ETSI EN 300 220-1, ETSI EN 300 220-2*
- *screw contacts to wires 2,5 mm²*

UGRADBENI ZATAMNJIVAČ LED 250 W



EM18

- ugradbeni, za povezivanje s tipkalom
- leading ili trailing edge
- napajanje 230 V[~] 50 Hz
- moguće povezivanje više tipkala
- ugrađena memorijska funkcija
- funkcija mekog uključivanja/isključivanja
- postavljanje minimalnog osvjetljenja
- montaža samo jednog uređaja u jednu dozu
- samo za unutrašnju uporabu
- usklađen s normama EN 60669-1 i EN 60669-2-1

DIMMER INBOX LED 250W

- *inbox, controlled by external push button*
- *for leading or trailing edge*
- *supply voltage 230V[~] 50Hz*
- *several push-buttons combinations is possible*
- *light intensity memory*
- *soft start / stop function*
- *minimum intensity control*
- *only one dimmer per wall box*
- *only for indoor usage*
- *in accordance with EN 60669-1 and EN 60669-2-1*

UGRADBENI ZATAMNJIVAČ DC LED 96 W



EM19

- ugradbeni, za povezivanje s tipkalom
- povezanost sa svim jedinicama napajanja LED rasvjete sa stalnim naponom i nekim jedinicama napajanja LED rasvjete sa stalnim tokom, 9 – 48 V DC, max 96 W
- nije namijenjeno uporabi s induktivnim opterećenjem
- moguće povezivanje više tipkala i zatamnivača
- ugrađena memorijska funkcija
- funkcija mekog uključivanja/isključivanja
- montaža samo jednog uređaja u jednu dozu
- samo za unutrašnju uporabu

DIMMER INBOX DC LED 96W

- *inbox, controlled by external push button*
- *for use with constant voltage LED drivers and some constant current LED drivers, 9-48V DC, max 96W (also for LED strips)*
- *not for use with inductive loads*
- *several push-buttons combinations and several dimmers is possible*
- *light intensity memory*
- *soft start / stop function*
- *only one dimmer per wall box*
- *only for indoor usage*

EM10 (40÷300W)
EM15 (40÷300W)

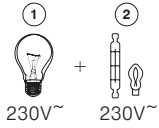

EM12 (40÷300W)

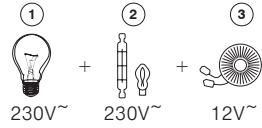

EM13 (0÷60W), EM14 (0÷180W),
EM23 (15÷250W, 15÷200VA),
EM18 (2÷250VA (3=10÷250VA), 2÷250W)

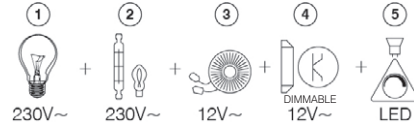

- 1 - žarulja sa žarnom niti / incandescent lamp
- 2 - halogena žarulja / halogen lamp
- 3 - klasični transformator / classical transformer
- 4 - elektronički transformator s regulatorom osvijetljenja / dimmable electronic transformer
- 5 - LED tinjalica s regulacijom osvijetljenja / dimmable LED lamp

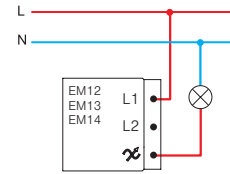
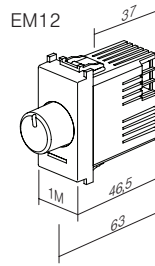
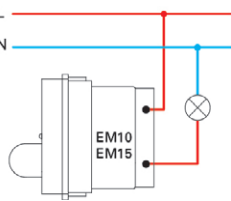
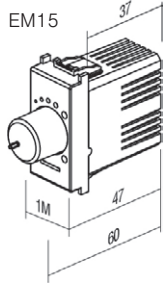
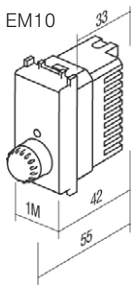

EM23

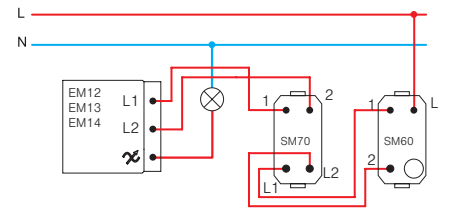
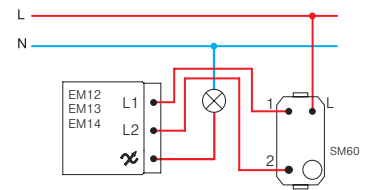
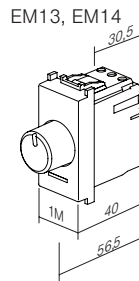
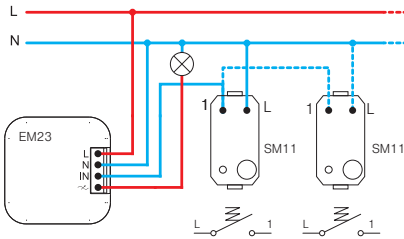
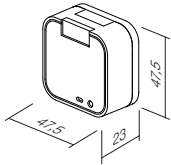

EM18

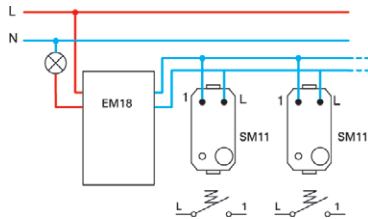
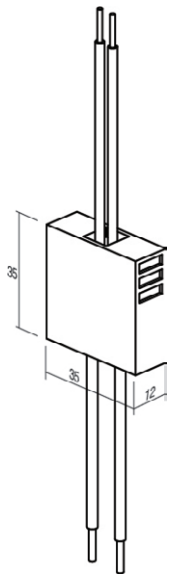

EM19

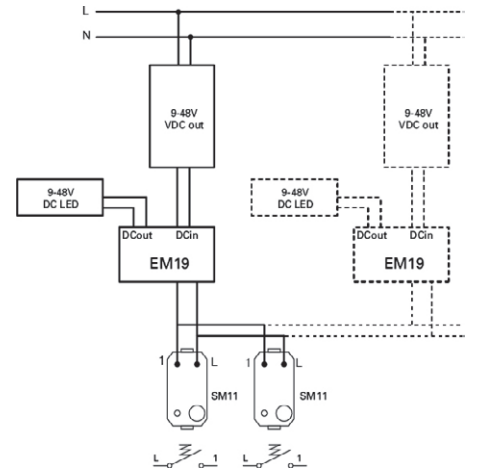
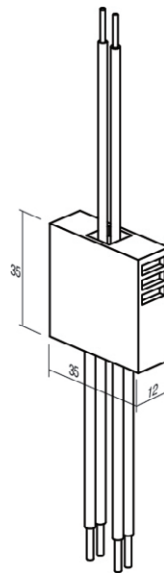

POZOR!

Ako se više regulatora osvijetljenja priključi u jednu kutiju, za svaki se dodatni regulator smanjuje maksimalna ukupna snaga za 10%.

ATTENTION!

If more dimmers are connected in one box reduce maximum common power for 10% for each dimmer.

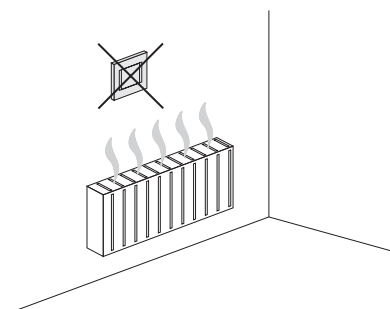

SKLOPKA / REGULATOR OSVJETLJENJA UNIVERZALNI RLC 0-300W 2M

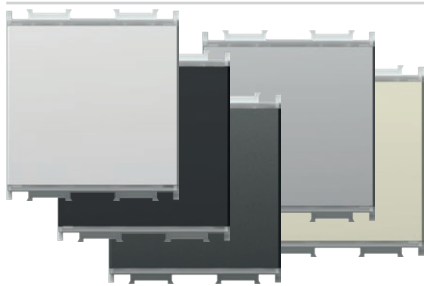

- EM25PW
- EM25SB
- EM25AT
- EM25ES
- EM25IW

- univerzalni elektronički regulator osvjetljenja za uključivanje i isključivanje i regulaciju osvjetljenja svih zatamnjenih žarulja (klasična, halogena, LED, CFL, ...) i nekih vrsta nezatamnjenih
- automatska detekcija tipa tinjalice i prilagodba režima rada
- smanjenje potrošnje energije
- funkcija usporenog starta produljuje vijek trajanja tinjalice
- kontrola preko ugrađene mikrosklopke
- ugrađena funkcija memorije – pri gašenju memorira stupanj svjetlosti
- može se priključiti do pet (5) dodatnih kontrolnih jedinica EM26
- nije moguće kombiniranje s izmjeničnom sklopkom
- ugrađena zaštita od kratkog spoja, pregrijavanja i preopterećenja
- mrežni napon 230V~ 50Hz
- elegantno LED osvjetljenje, prilagodljiva boja i stupanj osvjetljenja
- moguća zamjena klasične sklopke u dvožičnom spoju⁽¹⁾
- potpuna funkcionalnost postiže se u trožičnom spoju⁽²⁾
- sukladno normama EN 60669-1 i EN 60669-2-1
- vijčano pričvršćivanje vodiča presjeka 1,5 mm² (maks. moment zatezanja 0,4 Nm)



TOUCH EM25 je mikroprocesorski upravljani zatamnivač svjetla. Služi kao sklopka te zatamnivač za zatamnive i neke vrste nezatamnjenih žarulja. Ugrađeni mikroprocesor automatski prepoznaje vrstu žarulje i prilagođava način rada. Pamti razinu zatamnjenja nakon isključivanja, zahvaljujući ugrađenoj memorijskoj funkciji. Funkcija polaganog paljenja produžava vijek trajanja žarulje. U tipku integrirana elegantna LED rasvjeta omogućava razne boje i razine intenziteta. Moguće je spojiti do 5 dodatnih upravljačkih sklopki EM26 („slave“).

TOUCH EM25 is microprocessor controlled electronic light dimmer. It serves as switch and dimmer for dimmable and some of non-dimmable lamps. Integrated microprocessor automatically identifies the type of lamp and adjusts the operating mode. It remembers the level of dimming after switching off due to integrated memory function. Soft-start function extends the lamp service life. In button integrated elegant LED illumination enables many different colors and intensity levels. Optionally one can connect up to 5 additional control tasters EM26 (»slave«).

SWITCH / DIMMER UNIVERSAL RLC 0-300W 2M

- universal electronic dimmer for ON/OFF switching and dimming of all dimmable lamps (classical, halogen, LED, CFL, ...) and some non-dimmable lamps
- automatic detection of lamp type and adjustment of operating mode
- reduction of energy consumption
- soft start function extends life of lamps
- controlled by build-in micro switches
- memory function included – memorizes brightness on turn-off
- up to five (5) additional control units EM26 can be connected
- connection with 2-way switch is not possible
- build-in short-circuit, overheating and overload protection
- supply voltage 230V~ 50Hz
- elegant LED illumination, adjustable colour and brightness
- replacement of classical switch is possible at two-wire connection⁽¹⁾
- full functionality is achieved at three-wire connection⁽²⁾
- in accordance with EN 60669-1 and EN 60669-2-1
- screw contacts 1.5mm² (max. tightening torque 0.4Nm)

⁽¹⁾dvožični spoj
two-wire connection

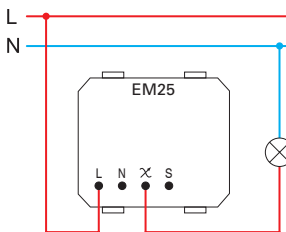

- dvožičano spajanje omogućava zatamnjenje zatamnjenih žarulja

- two-wire connection allows dimming of dimmable lamps

⁽²⁾trožični spoj
three-wire connection

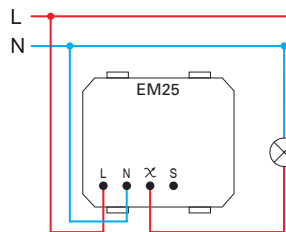

- trožičano spajanje omogućava zatamnjenje zatamnjenih žarulja te nekih nezatamnjenih LED i CFL lampi

- three-wire connection allows dimming of dimmable lamps and some of non-dimmable LED and CFL lamps

	1	2	5	6	7
Min.	40 W	40 W	40 VA	40 VA	40 VA
Max.	300 W	300 W	300 VA	100 VA	100 VA
	(F)	(F)	(F)		

1 - žarulja sa žarnom niti / incandescent lamp

2 - halogena žarulja / halogen lamp

4 - elektronički transformator s regulatorom osvjetljenja / dimmable electronic transformer

5 - klasični transformator / classical transformer

	1	2	4	6	7	8	9
Min.	0 W	0 W	0 VA	0 VA	0 VA	0 VA	0 VA
Max.	300 W	300 W	120 VA	120 VA	120 VA	120 VA	120 VA
	(F)	(F)	(F)			(F)	(F)

6 - štedna CFL tinjalica s regulacijom osvjetljenja / dimmable energy saving CFL lamp

7 - LED tinjalica s regulacijom osvjetljenja / dimmable LED lamp

8 - štedna CFL tinjalica bez regulacije osvjetljenja / non-dimmable energy saving CFL lamp

9 - LED tinjalica bez regulacije osvjetljenja / non-dimmable LED lamp

napomene / remarks

- (F) filter EM27
- preporučujemo korištenje EM27 filtra / it is recommended to use filter EM27
- sve spojene žarulje moraju biti jednake / all controlled lamps must be the same
- tablica opterećenja vrijedi za žarulje s faktorom PF>0,5 / table of loads is valid for lamps with power factor PF>0.5

paljenje / gašenje te zatamnivanje žarulje /
on / off switching and dimming of lamp

odabir boje i podešavanje intenziteta LED osvjetljenja /
LED colour selection and intensity level adjustment

*funkcija "RESET" /
"RESET" function

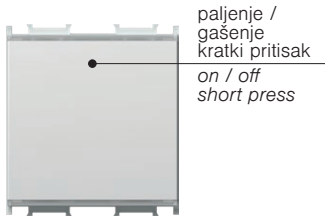

paljenje /
gašenje
kratki pritisak
on / off
short press

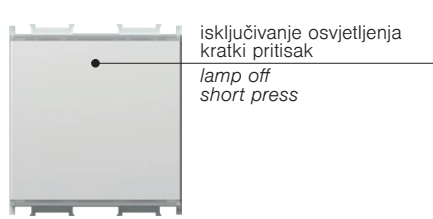

isključivanje osvjetljenja
kratki pritisak
lamp off
short press

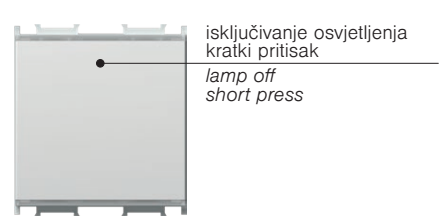

isključivanje osvjetljenja
kratki pritisak
lamp off
short press

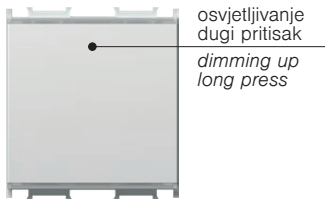

osvjetljivanje
dugi pritisak
dimming up
long press

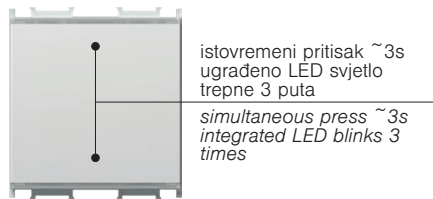

istovremeni pritisak ~3s
ugrađeno LED svjetlo
trepne 3 puta
simultaneous press ~3s
integrated LED blinks 3
times

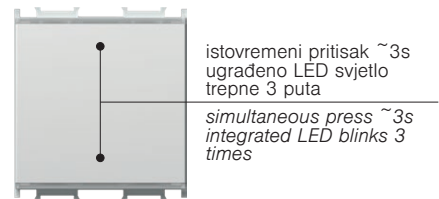

istovremeni pritisak ~3s
ugrađeno LED svjetlo
trepne 3 puta
simultaneous press ~3s
integrated LED blinks 3
times

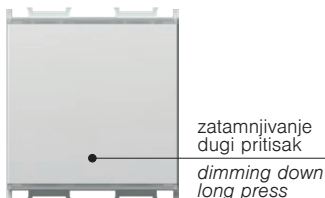

zatamnivanje
dugi pritisak
dimming down
long press

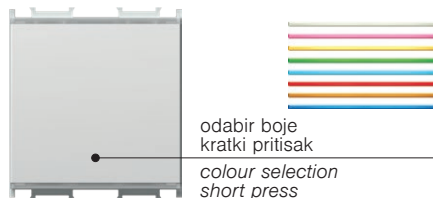

odabir boje
kratki pritisak
colour selection
short press

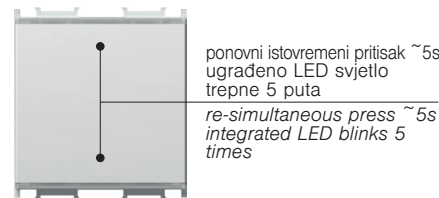

ponovni istovremeni pritisak ~5s
ugrađeno LED svjetlo
trepne 5 puta
re-simultaneous press ~5s
integrated LED blinks 5
times

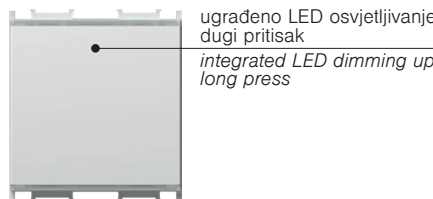

ugrađeno LED osvjetljivanje
dugi pritisak
integrated LED dimming up
long press

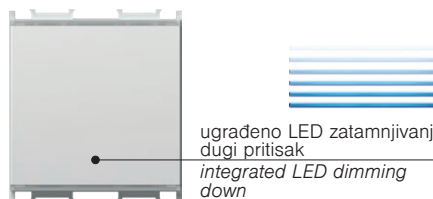

ugrađeno LED zatamnivanje
dugi pritisak
integrated LED dimming
down
long press

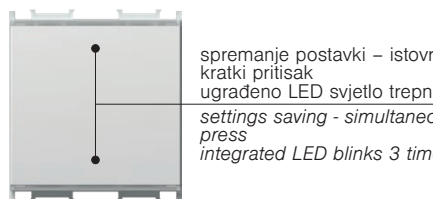

spremanje postavki – istovremeni
kratki pritisak
ugrađeno LED svjetlo trepne 3 puta
settings saving - simultaneous short
press
integrated LED blinks 3 times

- * - preporučuje se za ugradnju zatamnivača i pri zamjeni žarulje
- obavezno kod korištenja nezatamnivih žarulja
- funkcija "RESET" nije dostupna kod korištenja dvožičanog spajanja
- moguće samo za EM25
- it is recommended at dimmer installation and lamp replacement
- mandatory when using non-dimmable lamps
- "RESET" function is not possible when using two-wire connection
- only possible on EM25

upozorenja za ugradnju /

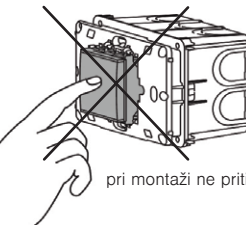
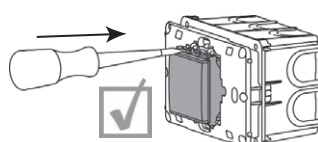
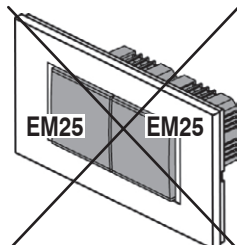
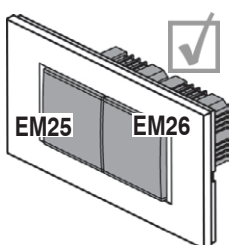

pri montaži ne pritišćite tipku /

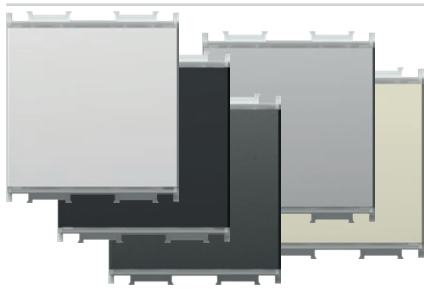

- EM26PW
- EM26SB
- EM26AT
- EM26ES
- EM26IW

UPRAVLJAČKA JEDINICA - TIPKALO 2M

- priključena na univerzalni regulator osvetljenja dopušta upravljanje tinjalicama s istom funkcionalnošću kao EM25
- mrežni napon 230V \sim 50Hz
- sukladno normama EN 60669-1 i EN 60669-2-1
- vijčano pričvršćivanje vodiča presjeka 1,5 mm² (maks. moment zatezanja 0,4 Nm)

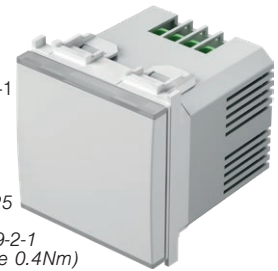

PUSH-BUTTON CONTROL UNIT 2M

- connected to universal dimmer EM25 allows controlling of lamps with same functionality as EM25
- supply voltage 230V \sim 50Hz
- in accordance with EN 60669-1 and EN 60669-2-1
- screw contacts 1.5mm² (max. tightening torque 0.4Nm)

(1) dvožični spoj
two-wire connection

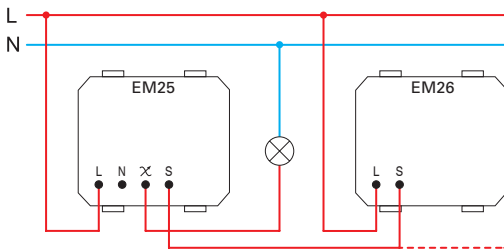

- dvožičano spajanje omogućava zatamnivanje zatamnjivih žarulja
- kod dvožičnog spajanja korištenje svake dodatne upravljačke jedinice povećava minimalno opterećenje za 25W

- two-wire connection allows dimming of dimmable lamps
- in a two-wire connection each additional control unit increases the minimum load by 25W

(2) trožični spoj
three-wire connection

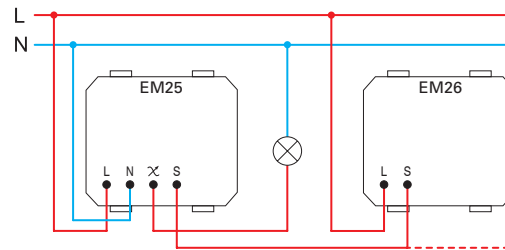

- trožičano spajanje omogućava zatamnivanje zatamnjivih žarulja te nekih nezatamnjivih LED i CFL lampi

- three-wire connection allows dimming of dimmable lamps and some of non-dimmable LED and CFL lamps

FREKVENCIJSKI FILTAR

EM27

- filter frekvencijskih smetnji za EM25
- prikaz je simboličan

FREQUENCY FILTER

- frequency filter for EM25
- image is symbolic

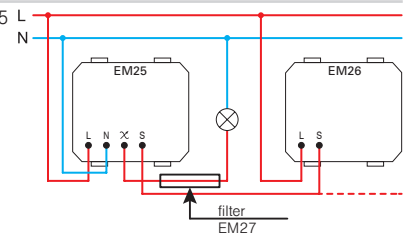

SET SKLOPKA / REGULATOR OSVJETLJENJA UNIVERZALNI RLC 0-300W 2M PP OL20

□ EM25PPOL20

- set uključuje regulator osvetljenja EM25, ugradbeni nosač 2M i okvir LINE 2M PW
- za tehničke detalje pogledajte EM25

SET SWITCH / DIMMER UNIVERSAL RLC 0-300W 2M PP OL20

- set includes dimmer EM25, mounting frame 2M and cover plate LINE 2M PW
- for technical details see EM25

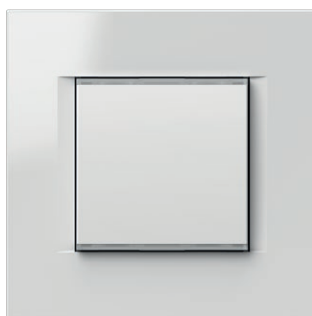

2M = 45 x 45

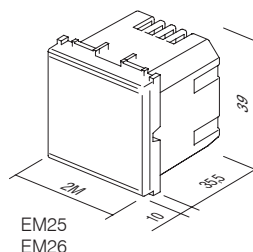

EM25
EM26

IR SKLOPKA 5A 230V~ 1M



- EM31PW
- EM31SB
- EM31AT
- EM31ES
- EM31IW

- IR infracrvena sklopka
- napajanje: 230V~ ± 10% 50Hz
- relej: 5A / 250V~ izlaz za ograničeni strujni tok s velikim otporom za prolaz kroz ništicu („zero crossing“)
- zaštitna razina: IP40
- presjek žica na kontaktnom terminalu: 0,75 - 2,5 mm²
- kut prepoznavanja: do 110° pri 20 °C
- raspon prepoznavanja: približno 8m pri 20 °C
- prilagodljivost trajanja: od približno 5 s do 12 min
- prilagodljivost osvijetljenja: od približno 5 do 200 LUX
- temperatura radnog okruženja: od 0 °C do +40 °C
- nije prikladan za ugradnju u kutije duboke 45 mm te podžbukne kutije CUBO IP20
- samo za unutrašnju uporabu



IR SWITCH 5A 230V~ 1M

- IR infrared switch
- supply voltage: 230V~ ±10 % 50Hz
- relay: 5A / 250V~ output for limited current with high resistance for zero crossing
- protection rating: IP40
- cross-section of wires at the contact terminal: 0.75 - 2.5 mm²
- detection angle: up to 110° at 20°C
- detection area: approx. 8 m at 20°C
- adjustability of duration: from approx. 5 s to 12 min
- adjustability of brightness: from approx. 5 to 200 LUX
- operating temperature: from 0°C to +40°C
- not suitable for installation in 45 mm deep boxes and surface mount box CUBO IP20
- only for indoor usage

IR SKLOPKA 5A 230V~ 2M



- EM32PW
- EM32SB
- EM32AT
- EM32ES
- EM32IW

- IR infracrvena sklopka
- napajanje: 230V~ ± 10% 50Hz
- relej: 5A / 250V~ izlaz za ograničeni strujni tok s velikim otporom za prolaz kroz ništicu („zero crossing“)
- zaštitna razina: IP40
- presjek žica na kontaktnom terminalu: 0,75 - 2,5 mm²
- kut prepoznavanja: do 110° pri 20 °C
- raspon prepoznavanja: približno 8m pri 20 °C
- prilagodljivost trajanja: od približno 5 s do 12 min
- prilagodljivost osvijetljenja: od približno 5 do 200 LUX
- temperatura radnog okruženja: od 0 °C do +40 °C
- nije prikladan za ugradnju u kutije duboke 45mm te podžbukne kutije CUBO IP20
- samo za unutrašnju uporabu

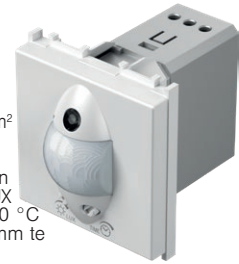

IR SWITCH 5A 230V~ 2M

- IR infrared switch
- supply voltage: 230V~ ±10 % 50Hz
- relay: 5A / 250V~ output for limited current with high resistance for zero crossing
- protection rating: IP40
- cross-section of wires at the contact terminal: 0.75 - 2.5 mm²
- detection angle: up to 110° at 20°C
- detection area: approx. 8 m at 20°C
- adjustability of duration: from approx. 5 s to 12 min
- adjustability of brightness: from approx. 5 to 200 LUX
- operating temperature: from 0°C to +40°C
- not suitable for installation in 45 mm deep boxes and surface mount box CUBO IP20
- only for indoor usage

mogućnost raspoznavanja

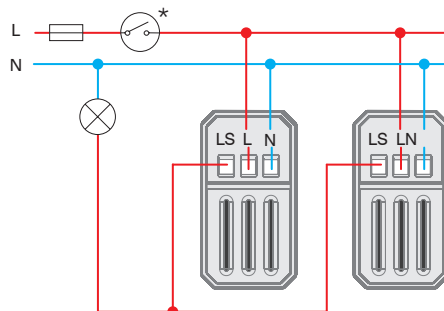
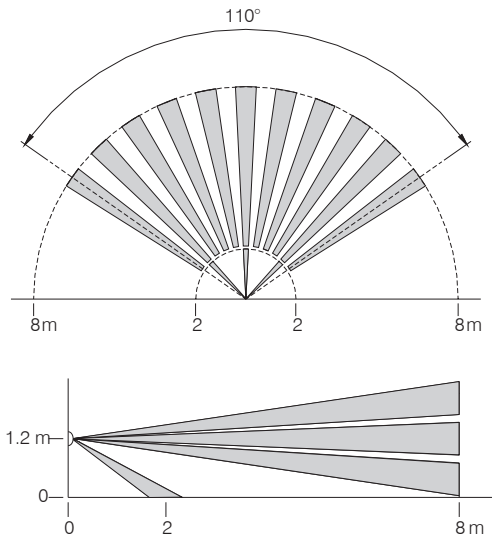

podešavanje vremena i osjetljivosti /

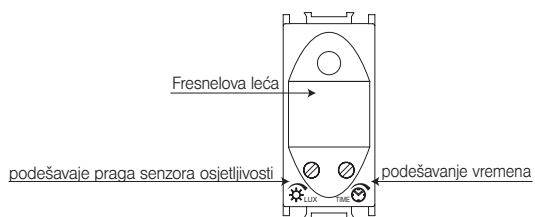

5 LUX	~5 s	200 LUX
		~12 min

	1	2	3	4	5	6	7	8
Min.	1 W	1 W		1 VA	1 W	1 W	1 VA	1 VA
Max.	800 W	800 W	5A	6x20 VA	6x36 W	4x36 W (20μF)	6x23 VA	6x20 VA

- 1 - žarulja sa žarnom niti /
- 2 - halogena žarulja /
- 3 - otporan grijaći element /
- 4 - elektronički transformator /
- 5 - fluorescentna cijev (izvedba 1) /
- 6 - fluorescentna cijev (izvedba 2) /
- 7 - štedna CFL žarulja /
- 8 - LED žarulja /

upozorenja /

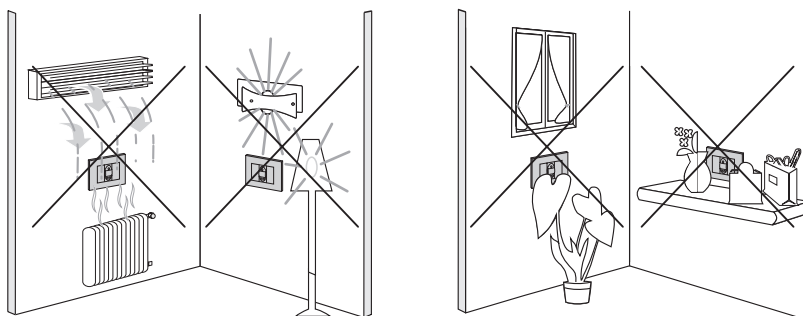

1M = 22,5 x 45

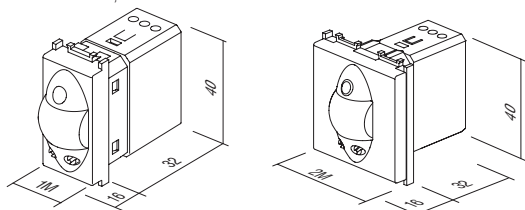

TERMOSTAT OSNOVNI 6A 230V~ 2M



- EM37PW
- EM37SB
- EM37AT
- EM37ES
- EM37IW

- elektronički termostat, osnovni
- način rada: grijanje / hlađenje / isključeno
- napajanje: 230 VAC, 50 Hz
- izlaz: 6(2) A, 230 VAC, relejna sklopka
- raspon regulacije: +10 °C do +30 °C
- histereza: ±0.5 °C, ED = 20min
- zaštita protiv smrzavanja (način grijanja): +6 °C
- zaštita protiv pregrijavanja (način hlađenja): +32 °C
- funkcija ECO za snižavanje temperature za 3 °C za 6 sati u načinu grijanja te povećanja temperature za 3 °C za 6 sati u načinu hlađenja
- prilagođena ECO funkcija, svaki dan automatski u isto vrijeme snižava temperaturu za 3 °C unutar 6 sati u načinu grijanja te povećava temperaturu za 3 °C unutar 6 sati u načinu hlađenja
- mogućnost uključivanja ECO funkcije vanjskim okidačem putem odvojenog unosa, LED indikator načina rada
- nije prikladan za električno podno grijanje
- vijčano pričvršćivanje vodiča presjeka maks. 2,5 mm²
- sukladno s LV Direktivom, EMC Direktivom, standardima EN60730-1 te EN60730-2-9
- za pravilno korištenje preporučujemo instaliranje u zasebnu kutiju, odvojenu od uređaja koji stvaraju toplinu
- temperatura korištenja: 5 ÷ 35 °C
- temperatura skladištenja: -20 ÷ 50 °C

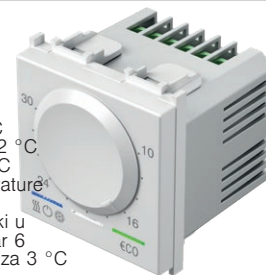

Termostat je namijenjen reguliranju temperature u prostoru. Termostat omogućava dva načina rada – grijanje ili hlađenje. Ugrađene su i sigurnosne funkcije protiv smrzavanja (način grijanja) te protiv pregrijavanja (način hlađenja). Način rada se označava preko LED osvjetljenja. Postavke termostata unose se pomoću okretnog mehanizma za postavljanje temperature te s drugim kapacitivnim dodirnim tipkama.

The thermostat is intended for regulating temperature in a room. A thermostat enables two modes of operation – heating or cooling. It has safety functions installed for protection against freezing (heating mode) and protection against overheating (cooling mode). The operation is indicated via LED lights. Thermostat setup is performed with the help of a rotary button for setting the temperature and with other capacitive touch buttons.

THERMOSTAT BASIC 6A 230 V ~ 2M

- electronic thermostat, basic
- operation mode: heating/cooling/turn off
- power supply: 230 VAC, 50 Hz
- output: 6(2) A, 230 VAC, relay switch
- regulation range: +10 °C to +30 °C
- hysteresis: ±0.5 °C, ED = 20min
- anti-freeze protection (heating mode): +6 °C
- overheating protection (cooling mode): +32 °C
- ECO function for lowering the temperature by 3 °C for 6 hours in the heating mode and raising temperature by 3 °C for 6 hours in the cooling mode
- adaptive ECO function, automatically every day at the same time lowers the temperature by 3 °C for 6 hours in the heating mode and raises temperature by 3 °C for 6 hours in the cooling mode
- option to turn on the ECO operating mode by external trigger via a separate input
- LED indication of operation
- not suitable for electrical floor heating
- screw contacts max. 2.5 mm²
- in accordance with the LV Directive, the EMC Directive, standards EN60730-1 and EN60730-2-9
- for correct operation, we recommend installing in an independent single box, separate from devices that generate heat
- operating temperature: 5 ÷ 35 °C
- storage temperature: -20 ÷ 50 °C

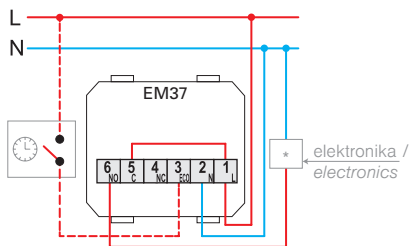

ciklulacijska crpka, plamenik (direktno spajanje)
termoelektrični pogon /
circulation pump, burner (direct connection)
thermoelectric drive

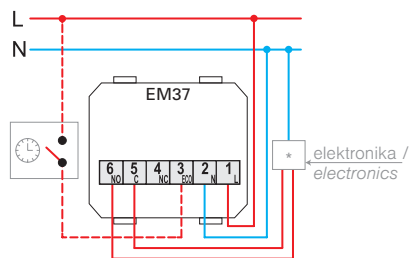

bojler, toplinska crpka, plamenik (upravljački unos T1/T2) /
boiler, heat pump, burner (control input T1/T2)

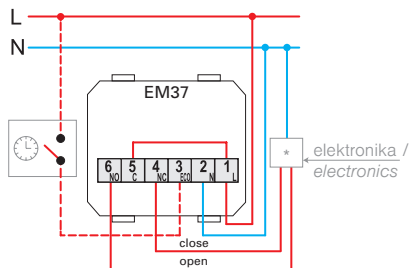

motorni pogon (ograničena uporaba s podnim grijanjem) /
motor drive (limited use with underfloor heating)

postavljanje načina rada i temperature /
function and temperature adjustment

tipka za izbor načina rada i LED indikator stanja:
crvena: grijanje
plava: hlađenje
ne svijetli: isključeno

function selection button and LED status indicator:
red: heating
blue: air conditioning
no light: switched off

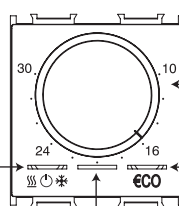

postavljanje temperature
temperature setting

tipka za izbor "ECO" načina i LED indikator "ECO" načina
zelena: ECO ušteda energije UKLJUČENA
narančasta: aktiviran prilagođeni ECO način
ne svijetli: dnevni način

"ECO" function selection button and LED "ECO" status indicator
green: ECO energy saving ON
orange: adaptive ECO mode activated
no light: day mode

LED indikator stanja izlaznog releja
bijela: relej uključen
ne svijetli: relej isključen

LED output relay state indicator
white: relay ON
no light: relay OFF

upozorenja /
attention

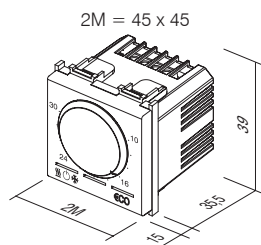
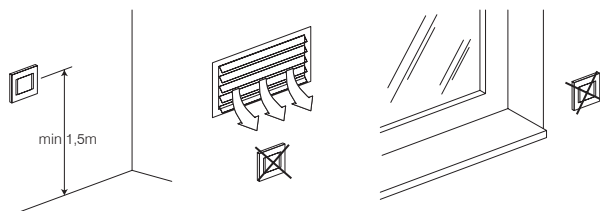

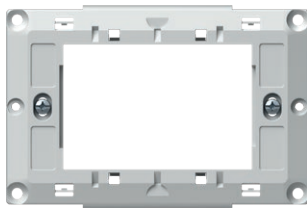

NM39

NOSAČ S VIJCIMA ZA TERMOSTATE FANTINI COSMI 3M

- nosač s vijcima za termostate Fantini Cosmi 3M
- prikladan za korištenje s dnevnim termostatima Fantini Cosmi modela CH121 i CH123
- prikladan za korištenje s tjednim termostatima Fantini Cosmi modela CH141A i CH143A
- ugradnja u pravokutne kutije 3M
- prikladan za kombiniranje s okvirima PURE, Line, Soft



MOUNTING FRAME WITH SCREWS FOR FANTINI COSMI THERMOSTATS 3M

- mounting frame with screws for Fantini Cosmi thermostats 3M
- suitable for use with Fantini Cosmi daily thermostats models CH121 and CH123
- suitable for use with Fantini Cosmi weekly thermostats models CH141A and CH143A
- for mounting in rectangular boxes 3M
- suitable for assembling with cover plates PURE, Line, Soft



- EM40PW
- EM40SB
- EM40AT
- EM40ES
- EM40IW

ŠTEDNA KARTIČNA SKLOPKA 3A 250V~ 3M

- osnovna kartična sklopka, za bilo koju ISO karticu
- mrežni napon 230V~ 50Hz
- izlaz: 3A 250V~ za sklopnik*
- zadržka isklopa 15-20s
- sukladno normi EN 61000-6-1
- kartica nije priložena
- nije za kontrolu pristupa



ENERGY SAVER CARD SWITCH 3A 250V~ 3M

- card switch basic, any ISO card
- supply voltage 230V~ 50Hz
- output 3A 250V~ for switching contactor *
- switch off delay 15-20s
- in accordance with EN 61000-6-1
- card is not included
- not for access control

3M = 67,5 x 45

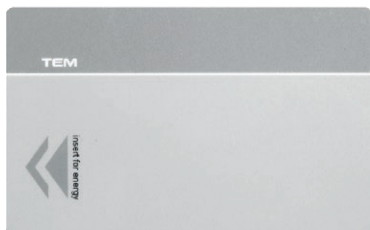
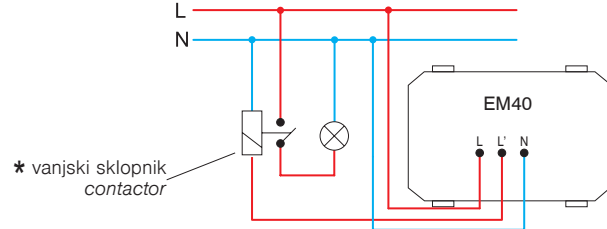
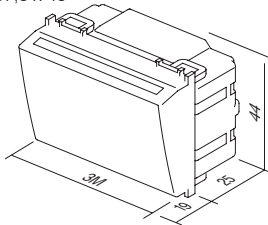

EM47

KARTICA ISO

- ISO kartica
- za uporabu s kartičnom sklopkom EM40
- veličina: 85x54 mm

CARD ISO

- ISO card
- for combination with card switch EM40
- size: 85x54 mm

ŠTEDNA KARTIČNA SKLOPKA RF HF 13,56MHz 3M



EM44BK

- kartična sklopka elektronska za RFID ISO karticu
- napajanje iz relejne jedinice EM49 putem kablovskih konektora RJ12
- izlaz treba biti spojen na relejni izlaz EM49
- 15-20s zadržka isklopa „glavnog napajanja” s povlačenjem kartice
- 1 min zadržka isklopa „HVAC” s povlačenjem kartice prilikom otvaranja balkonskih vrata ili prozora
- sukladno normi EN 61000-6-1
- kartica nije priložena
- nije za kontrolu pristupa

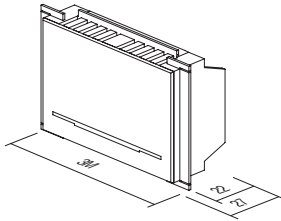

ENERGY SAVER CARD SWITCH RF HF 13,56MHz 3M

- electronic card switch for RFID ISO card
- supply from relay unit EM49 through cable connectors RJ12
- output to be connected to relay output unit EM49
- 15-20s "main power" switch off delay with card withdrawal
- 1 min "HVAC" switch off delay with card withdrawal when balcony doors or windows opened
- in accordance with EN 61000-6-1
- card is not included
- not for access control

ŠTEDNA KONTROLNA JEDINICA 2x16A 250V~

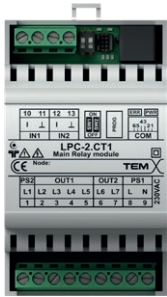

EM49

- relejna jedinica za kartične sklopke EM44
- mrežni napon 230V~ 50Hz
- sukladno normi EN 61000-6-1
- montaža na DIN tračnicu 35 mm, 4MU
- ulaz i izlaz ovisno o primjeni: jednokrevetna ili dvokrevetna soba

ENERGY SAVER CONTROL UNIT 2x16A 250V~

- relay unit for card switches EM44
- supply voltage 230V~ 50Hz
- in accordance with EN 61000-6-1
- mounting on DIN rail 35mm, 3MU
- input and output depending on implementation: single or double room

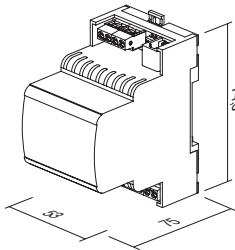

RAZDVAJAČ SPL-1

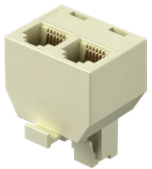

EM45

- koristi se za spajanje dva periferna modula EM44 s relejnom jedinicom EM49
- komunikacijski konektor RJ12
- veličina: 37 x 30 x 27 mm

SPLITTER SPL-1

- used to connect two peripheral modules EM44 to relay unit EM49
- communication connector RJ12
- size: 37 x 30 x 27 mm

dijagram spajanja za primjenu u jednokrevetnoj sobi / wiring diagram for single room implementation

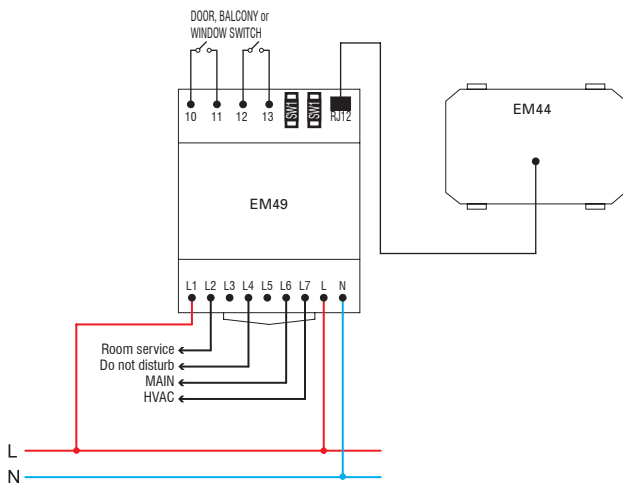

dijagram spajanja za primjenu u dvokrevetnoj sobi / wiring diagram for double room implementation

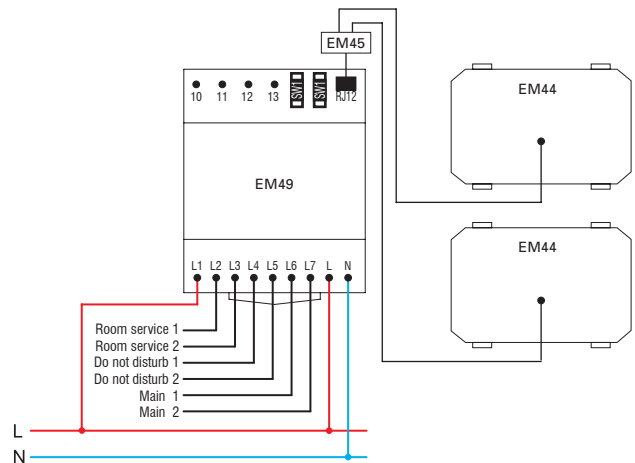

priključni kabel RJ12 između EM44 i EM49 / connection cable RJ12 between EM44 and EM49

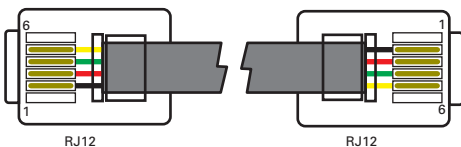



- EM60PW
- EM60SB
- EM60AT
- EM60ES
- EM60IW

3M = 67,5 x 45

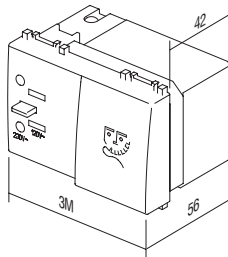

UTIČNICA ZA BRIJAČI APARAT 230V~/120V~ 3M

- utičnica za brijači aparat s izolacijskim transformatorom 20VA
- napajanje: 230V~ 50-60Hz
- izlaz: 230V~ za 2P 2,5A euro utikac ili 120V~ za 2P 15A američki utikač
- razred II
- sukladno normi EN 61558-2-5

SOCKET SHAVER 230V~/120V~ 3M

- shaver supply unit with isolating transformer 20VA
- supply: 230V~ 50-60Hz
- output: 230V~ for 2P 2.5A Europlug or 120V~ for 2P 15A American plug
- Class II
- in accordance with EN 61558-2-5

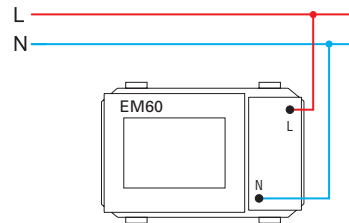

- EM66PW
- EM66SB
- EM66AT
- EM66ES
- EM66IW

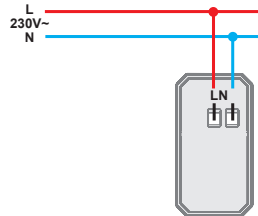
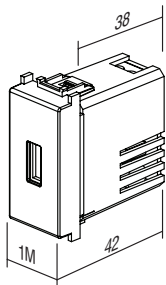

JEDINICA NAPAJANJA 5V 2,1A 1M

- Za punjenje elektroničkih uređaja putem standardnog USB priključka (sukladno i s Apple uređajima)
- napajanje: 100 – 230 V~ 50/60 Hz
- potrošnja: 300 mA pri 100 V~/150 mA pri 230 V~
- potrošnja pri mirovanju: 30 mW pri 230 V~
- nazivni izlazni napon: 5 VDC (±5 %) SELV
- nihanje (ripple) izlaznog napona: 150 mV
- nazivna izlazna snaga: 2,1 A (1x 2.100 mA) (±10 %)
- učinkovitost: maks. 77 %
- radna temperatura: 0 °C/+ 45 °C (unutarnja uporaba)
- IP zaštitni razred: IP20, samo za unutarnju uporabu
- gurnosni razred uređaja II
- prenaponska kategorija (EN 62109): Klasa III
- vijčano pričvršćivanje vodiča presjeka maks. 2,5 mm²
- uređaj s razmakom kontakta od najmanje 3 mm
- sukladno standardu EN 60950-1 te LVD i EMC direktivama



USB POWER SUPPLY UNIT 5V 2,1A 1M

- for charging of electronic devices via a standard USB port (also compatible with Apple devices)
- power supply: 100-230V~ 50/60Hz
- power consumption: 300mA at 100V~/150mA at 230V~
- standby power consumption: 30mW at 230V~
- nominal output voltage: 5 VCD (± 5%) SELV
- output ripple voltage: 150mV
- nominal output current: 2,1A (1 x 2.100mA) (±10%)
- efficiency: maximum of 77%
- operating temperature: 0°C/+45°C (indoor use)
- IP protection class: IP20, indoor use only
- class device II
- overvoltage category (EN 62109): Class III
- screw contacts: max. 2.5 mm²
- device with a contact gap of at least 3mm
- in accordance with EN 60950-1 and LVD & EMC directives

USB PUNJAČ 5V 1A 2M

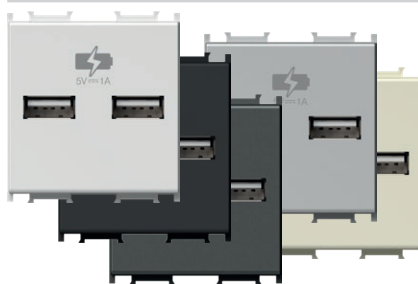

- EM65PW
- EM65SB
- EM65AT
- EM65ES
- EM65IW

2M = 45 x 45

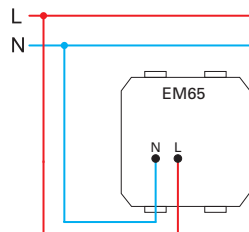
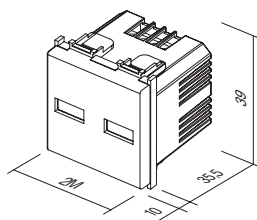

- za punjenje elektroničkih uređaja putem standardnog USB priključka (sukladno i s Apple uređajima)
- omogućava istovremeno punjenje dva uređaja
- napajanje: 230V~ 50Hz
- potrošnja pri mirovanju: 50 mW pri 230V~
- nazivni izlazni napon: 5 VDC (±5%) SELV
- nihanje (ripple) izlaznog napona: 150 mV
- nazivna izlazna snaga: 1A (1x 1.000mA ili 2 x 500mA) (±10%)
- učinkovitost: veća od 67%
- IP zaštitni razred: IP20, samo za unutrašnju uporabu
- vijčano pričvršćivanje vodiča presjeka maks. 2,5 mm²
- sukladno standardu EN 60950-1 te EMC direktivi
- kao dio instalacije potrebno je uzeti u obzir odgovarajući vanjski uređaj za isključivanje



POWER SUPPLY UNIT USB 5V 1A 2M

- for charging of electronic devices via a standard USB port (also compatible with Apple devices)
- enables charging of two devices simultaneously
- power supply: 230V~ 50Hz
- stand-by power consumption: 50 mW at 230V~
- nominal output voltage: 5 VDC (±5%) SELV
- output ripple voltage: 150 mV
- nominal output current: 1 A (1 x 1.000 mA or 2 x 500 mA) (±10%)
- efficiency: greater than 67%
- IP protection class: IP20, indoor use only
- screw contacts: max. 2.5 mm²
- in accordance with EN 60950-1 and EMC directive
- an appropriate external disconnect device needs to be considered as part of installation

JEDINICA NAPAJANJA 5V 2,4A 1M



- EM67PW
- EM67SB
- EM67AT
- EM67ES
- EM67IW

- Za punjenje elektroničkih uređaja putem standardnog USB priključka (sukladno i s Apple uređajima)
- napajanje: 100 – 230 V \sim 50/60 Hz
- potrošnja: 300 mA pri 100 V \sim / 150 mA pri 230 V \sim
- potrošnja pri mirovanju: 30 mW pri 230 V \sim
- nazivni izlazni napon: 5 VDC (\pm 5 %) SELV
- njihanje (ripple) izlaznog napona: 150 mV
- nazivna izlazna snaga: 2,4A (\pm 10 %)
- učinkovitost: maks. 77 %
- radna temperatura: 0 °C/+ 45 °C (unutarnja uporaba)
- IP zaštitni razred: IP20, samo za unutarnju uporabu
- gurnosni razred uređaja II
- prenaponska kategorija (EN 62109): Klasa III
- vijčano pričvršćivanje vodica presjeka maks. 2,5 mm 2
- uređaj s razmakom kontakta od najmanje 3 mm
- sukladno standardu EN 60950-1 te LVD i EMC direktivama

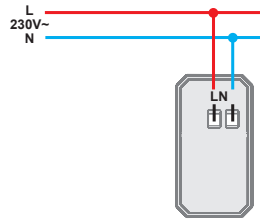
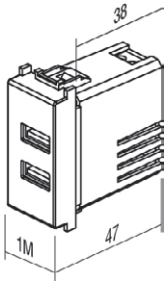

USB POWER SUPPLY UNIT 5V 2,4A 1M

- for charging of electronic devices via a standard USB port (also compatible with Apple devices)
- power supply: 100-230V \sim 50/60Hz
- power consumption: 300mA at 100V \sim /150mA at 230V \sim
- standby power consumption: 30mW at 230V \sim
- nominal output voltage: 5 VCD (\pm 5%) SELV
- output ripple voltage: 150mV
- nominal output current: 2,4A (\pm 10%)
- efficiency: maximum of 77%
- operating temperature: 0°C/+45°C (indoor use)
- IP protection class: IP20, indoor use only
- class device II
- overvoltage category (EN 62109): Class III
- screw contacts: max. 2.5 mm 2
- device with a contact gap of at least 3mm
- in accordance with EN 60950-1 and LVD & EMC directives

LED SVJETILKA ZA SLUČAJ NUŽDE 250V~ 0.9W, NiCd 3h 7M



□ EM55

- LED svjetiljka za slučaj nužde
- mrežni napon 250V \sim 50Hz 3xLED 0,3W LED, 10000mcd, 6500K
- NiCd akumulator 400 mAh, zamjenjiv
- autonoman rad 3 h, punjenje 24 h
- razred II
- sukladno normama EN 60598-1, EN 60598-2-2, EN 60598-2-22



LED EMERGENCY LIGHT 250V~ 0.90W, NiCd 3h 7M

- emergency LED lamp
- supply voltage 250V \sim 50Hz 3x LED 0,3W, 10000mcd, 6500K
- NiCd accumulator 400 mAh, replaceable
- autonomy 3h, charging 24h
- Class II
- in accordance with EN 60598-1, EN 60598-2-2, EN 60598-2-22

7M = 151,5 x 45

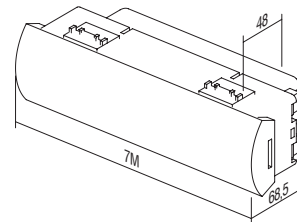
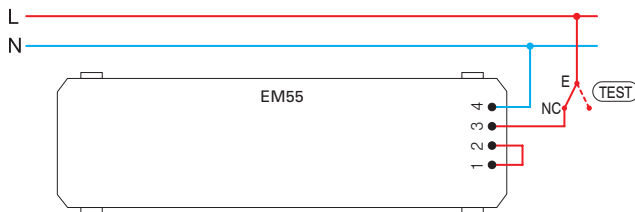

LED SVJETILKA ZA SLUČAJ NUŽDE 230V~ 50 Hz 0,5W, NiMH 2h 2M



EM57

- LED svjetiljka za slučaj nužde
- može se upotrebljavati kao prijenosna ručna svjetiljka (mehanizam na izvlačenje)
- mrežni napon 230V \sim 50Hz 1xLED 0,5W
- NiMH akumulator 140 mAh, zamjenjiv
- autonoman rad 2 h, punjenje 36 h
- razred II
- sukladno normama EN 60598-1, EN60598-2-2, EN62471, EN55015:2006, EN61547

LED EMERGENCY LIGHT 230V~50Hz, 0.5W, NiMH 2h 2M

- emergency LED lamp
- option to use it as a hand lamp (pull-out mechanism)
- supply voltage 230V \sim 50Hz, 1xLED 0.5W
- NiMH accumulator 140mAh, replaceable
- autonomy 2h, charging 36h
- class device II
- in accordance EN60598-1, EN60598-2-2, EN62471, EN55015:2006, EN61547

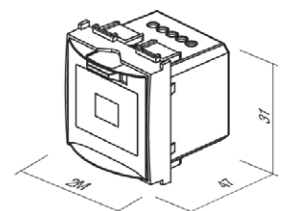
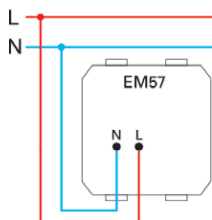
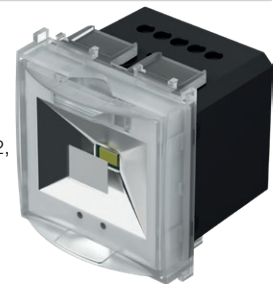

LED SVJETILJKA JEDNOBOJNA 250V~ 0,8W 2M

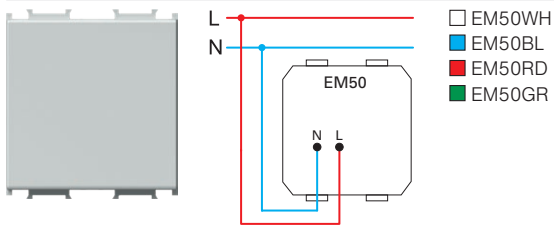

- LED svjetiljka za označavanje stepenica
- mrežni napon 230V~ 50Hz 0,8W, 6500K
- razred II
- sukladno normi EN 60598-1
- opcionalna uporaba za osvjetljavanje pravca ili signaliziranje s laserskom gravurom na difuzeru prema želji korisnika

LED LAMP MONOCOLOR 250V~ 0,8W 2M

- step marker LED lamp
- supply voltage 230V~ 50Hz 0,8W, 6500K
- Class II
- in accordance with EN 60598-1
- optional usage for directional or signal illumination with customized laser printing on diffuser



LED SVJETILJKA DVOBOJNA 250V~ 2x0,4W 2M

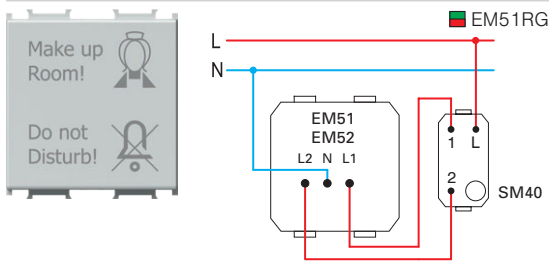

- LED svjetiljka s dvobojnom signalizacijom (crveno/zelenom)
- mrežni napon 230V~ 50Hz 2x0,4W, 6500K
- razred II
- sukladno normi EN 60598-1
- difuzer obuhvaća i grafiku prema prikazu
- moguć laserski otisak na difuzeru prema želji korisnika

LED LAMP DUAL COLOR 250V~ 2x0,4W 2M

- signaling dual color (red/green) LED lamp
- supply voltage 230V~ 50Hz 2x0,4W, 6500K
- Class II
- in accordance with EN 60598-1
- diffuser includes graphics as shown
- possible customized laser printing on diffuser



LED SVJETILJKA 3D DVOBOJNA 250V~ 2x0,4W 2M

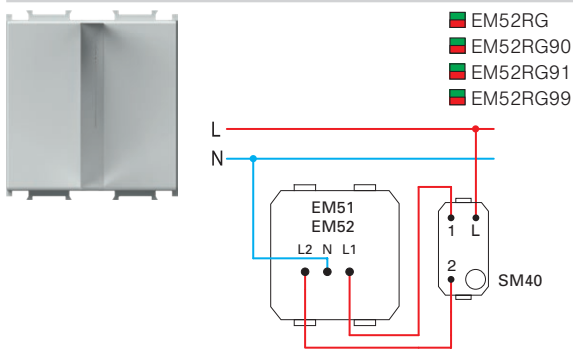

- LED dvobojna svjetiljka (crvena/zelena) s 3D simbolom, za označavanje
- mrežni napon 230V~ 50Hz 2x0,4W, 6500K
- razred II
- sukladno normi EN 60598-1
- mogućnost otiska prilagođenih grafika po želji
- 90 muških simbola, 91 ženski simbol, 99 simbola na zahtjev

LED LAMP 3D DUAL COLOR 250V~ 2x0,4W 2M

- signalling LED lamp, dual color (red/green) with 3D symbol
- supply voltage 230V~ 50Hz 2x0,4W, 6500K
- class II
- in accordance with EN 60598-1
- possible customized graphics on request
- 90 male symbol, 91 female symbol, 99 symbol on request

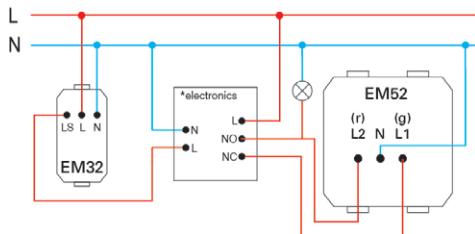
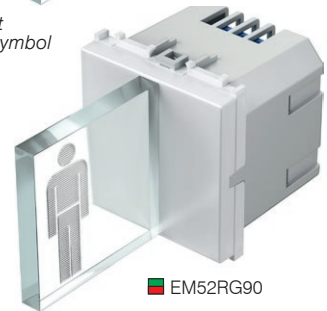
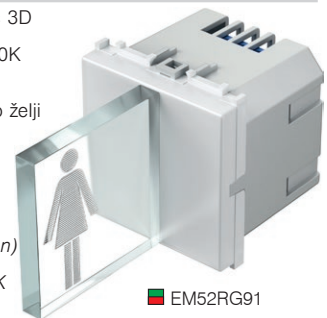

2M = 45 x 45

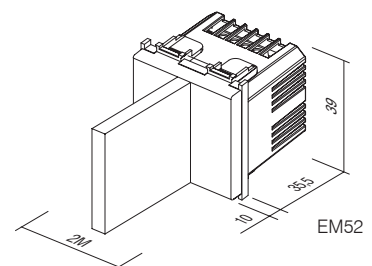
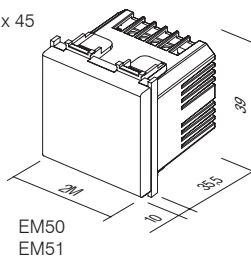

PREKIDAČ NA OTISAK PRSTA BIOPASS 2M



- EM71PW
- EM71SB
- EM71AT
- EM71ES
- EM71W

- prekidač na otisak prsta u kompletu s unutarnjom relejnom jedinicom i uređajem za napajanje
- kapacitet: 500 otisaka prsta
- jednostavno upravljanje s pomoću mobilne aplikacije X-Manager
- napon napajanja: 8 – 30 V – DC ili AC (uređaj za napajanje uključen)
- kapacitivni senzor
- 2 izlazna releja
- maksimalni napon/struja na releju: 40 V/3 A
- vrijeme pokretanja releja: 1 – 10 s
- maksimalna snaga: 3,6 W
- 256-bitna enkripcija veze između prekidača i unutarnje relejne jedinice
- Set također uključuje nosač NM24 i dekorativni okvir OS20.

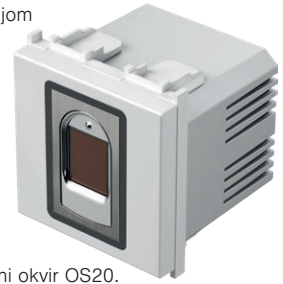

FINGERPRINT SWITCH BIOPASS 2M

- fingerprint switch with included internal relay unit and power supply
- capacity: 500 fingerprints
- easy management via X-Manager mobile app
- power supply voltage: 8-30V – DC or AC (power supply included)
- capacitive sensor
- 2 output relays
- maximum voltage/current on relay: 40V/3A
- relay triggering time: 1-10 sec
- maximum power: 3.6W
- 256-bit encrypted link between switch and internal relay unit
- Set also includes NM24 mounting frame and OS20 decorative cover plate.

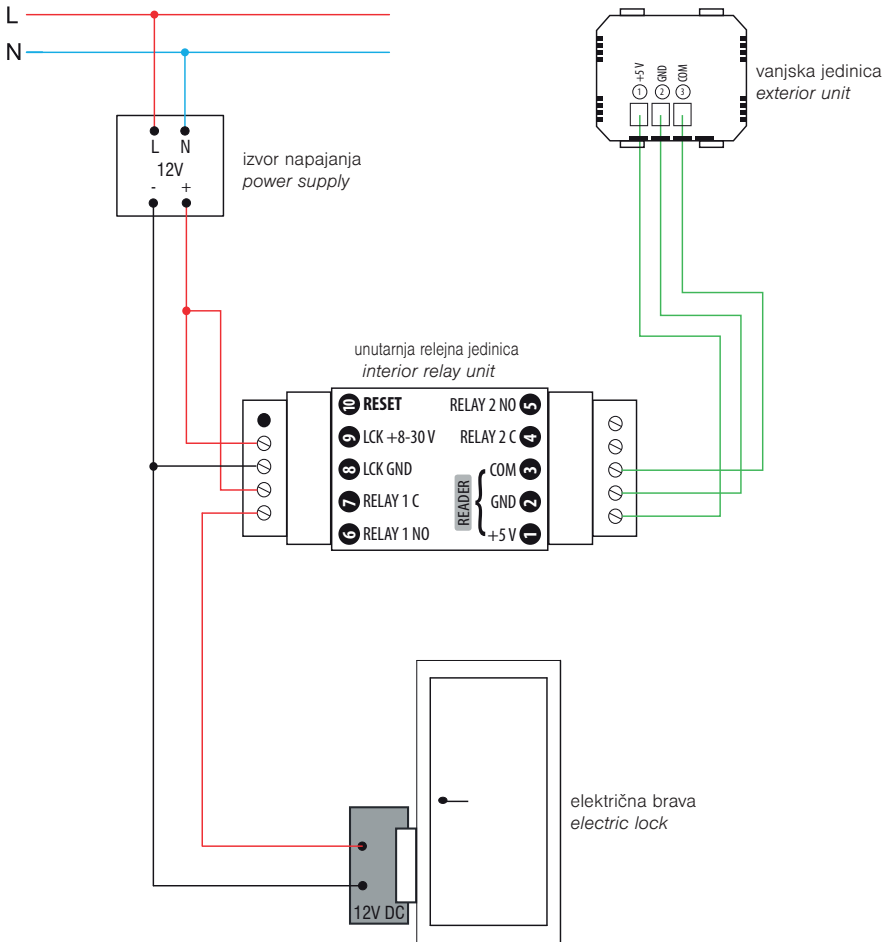

X-Manager app



support.tem.si



vanjska jedinica exterior unit

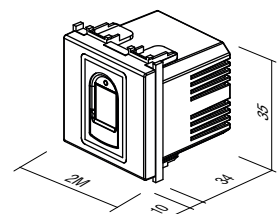

SKLOPKA, BESKONTAKTNA 10A 240V~



■ EM80GW

- beskontaktna sklopka za uključivanje i isključivanje („glavna“)
- napajanje: 240 V~ 50 Hz
- izlazni relej 10A / 250V~ (2400W pri 240V~)
- prilagodljivi raspon od 2 do 10 cm
- namijenjeno za ugradnju u standardnu okruglu kutiju Ø60 mm
- neutralan kabel (N) je potreban za spajanje
- nije moguće kombiniranje polužnom sklopkom
- moguće je povezivanje s do 5 EM81 upravljačkih sklopki
- jednostavna ugradnja dekorativnih poklopaca uz pomoć magnetskih gnetova
- vijčano pričvršćivanje kabela do 2.5 mm² (maks. vijčani moment zatezanja 0.4 Nm)
- sukladno normama EN 60669-1 i EN 60669-2-1
- samo za unutrašnju uporabu



SWITCH, TOUCHLESS 10A 240V~

- touchless switch for turning on/off (“master”)
- power supply: 240 V~ 50 Hz
- output relay 10A / 250V~ (2400W at 240V~)
- adjustable range from 2 to 10 cm
- intended for installation into a standard round Ø60 mm box
- a neutral lead (N) is required for connection
- connection with toggle switches is not possible
- connection with up to 5 EM81 control switches is possible
- simple installation of decorative covers with the help of magnets
- screw fastening of leads up to 2.5 mm² (max. screw tightening torque is 0.4 Nm)
- in accordance with EN 60669-1 and EN 60669-2-1
- only for indoor use



■ EM81GW

- upravljačka sklopka (“slave”)
- radi samo kad je spojena sa sklopkom EM80 („glavna”)
- prilagodljivi raspon od 2 do 10 cm
- jednostavna ugradnja dekorativnih poklopaca uz pomoć magnetskih gnetova
- vijčano pričvršćivanje kabela do 2.5 mm² (maks. vijčani moment zatezanja 0.4 Nm)
- sukladno normama EN 60669-1 i EN 60669-2-1
- samo za unutrašnju uporabu



SWITCH, TOUCHLESS, CONTROL UNIT

- control switch (“slave”)
- works only when connected with the EM80 switch (“master”)
- adjustable range from 2 to 10 cm
- simple installation of decorative covers with the help of magnets
- screw fastening of leads up to 2.5 mm² (max. screw tightening torque is 0.4 Nm)
- in accordance with EN 60669-1 and EN 60669-2-1
- only for indoor use

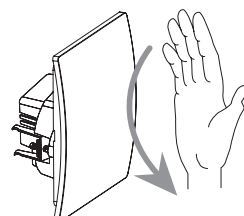
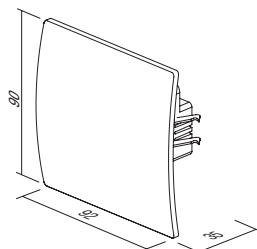
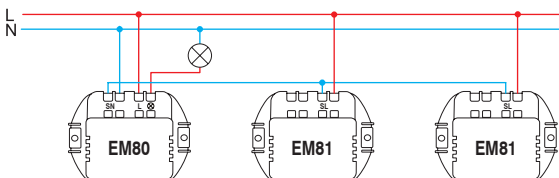
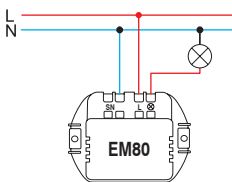

ZVONO 8VA 230V~ 1M

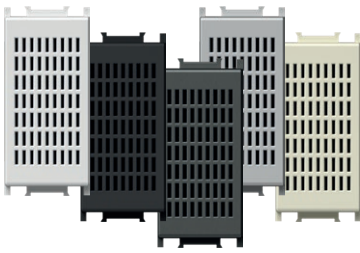

- EM90PW
- EM90SB
- EM90AT
- EM90ES
- EM90IW

- signalno zvono
 - emisija zvuka traje vremenski jednako kao i postupak posluživanja
 - mrežni napon 230V~ 50Hz 8VA

BUZZER 8VA 230V~1M

- signal buzzer
 - the sound emission has the same lasting time as the control operation
 - supply voltage 230V~ 50Hz 8VA



ZVONO 8VA 12V~ 1M

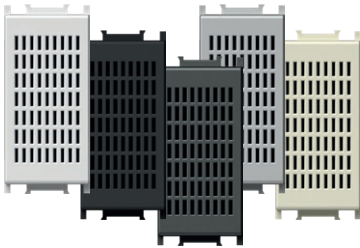

- EM91PW
- EM91SB
- EM91AT
- EM91ES
- EM91IW

- signalno zvono
 - emisija zvuka traje vremenski jednako kao i postupak posluživanja
 - mrežni napon 12V~ 50Hz 8VA

BUZZER 8VA 12V~1M

- signal buzzer
 - the sound emission has the same lasting time as the control operation
 - supply voltage 12V~ 50Hz 8VA



ZVONO 8VA 230V~ 1M

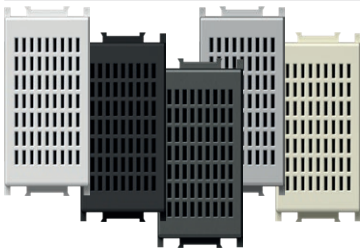

- EM92PW
- EM92SB
- EM92AT
- EM92ES
- EM92IW

- signalno zvono
 - emisija zvuka traje vremenski jednako kao i postupak posluživanja
 - mrežni napon 230V~ 50Hz 8VA

BELL 8VA 230V~1M

- signal bell
 - the sound emission has the same lasting time as the control operation
 - supply voltage 230V~ 50Hz 8VA



ZVONO 8VA 12V~ 1M

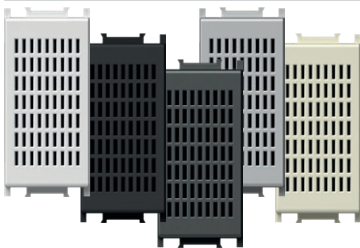

- EM93PW
- EM93SB
- EM93AT
- EM93ES
- EM93IW

- signalno zvono
 - emisija zvuka traje vremenski jednako kao i postupak posluživanja
 - mrežni napon 12V~ 50Hz 8VA

BELL 8VA 12V~1M

- signal bell
 - the sound emission has the same lasting time as the control operation
 - supply voltage 12V~ 50Hz 8VA

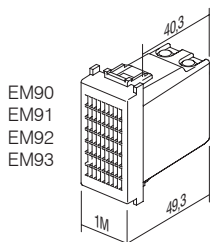

EM90
 EM91
 EM92
 EM93

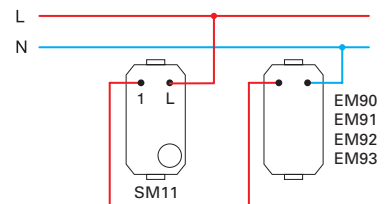

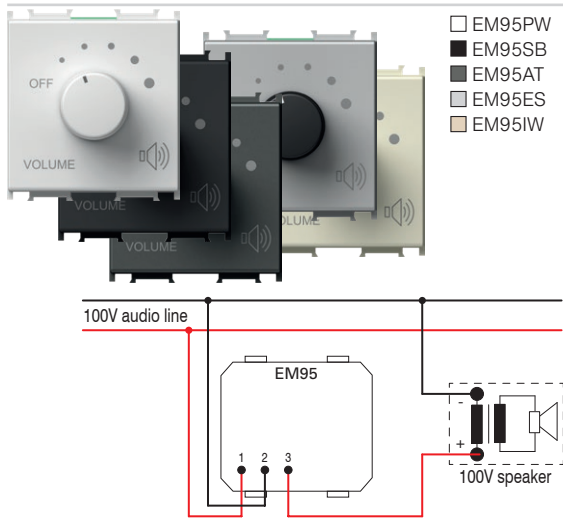

REGULATOR GLASNOĆE ZA 100V AUDIO LINIJU 35W 2M

- regulator glasnoće (atenuator) za 100V audio sustave
- nazivna snaga 35W (maks.45W), 6 razina glasnoće
- prikladan za ugradnju u kutije najmanje 60 mm dubine
- nije prikladan za ugradnju u kutije dubine 45 mm te podžbuknu ugradnju u kutije CUBO IP20
- samo za unutrašnju uporabu

VOLUME CONTROL 100V AUDIO LINE 35W 2M

- volume control (attenuator) for 100V audio systems
- power rating 35W (max.45W), 6 steps volume control
- suitable for boxes min. 60 mm deep
- not suitable for installation in 45 mm deep boxes and surface mount boxes CUBO IP20
- for indoor use only

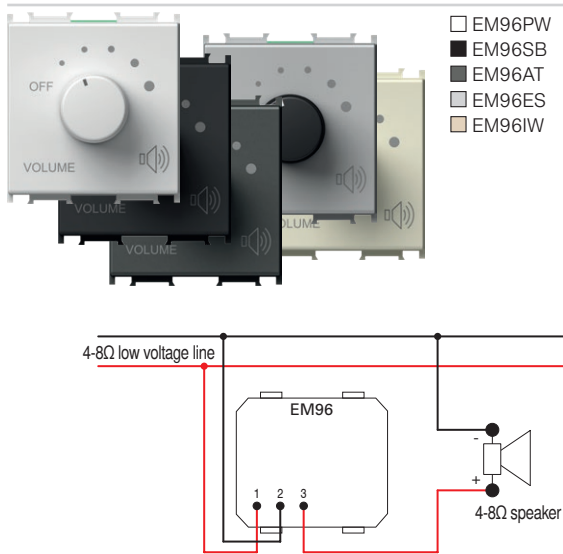

REGULATOR GLASNOĆE 4-8 Ω 35W 2M

- regulator glasnoće za niskonaponske izlaze 4-8 Ω, 35W
- nazivna snaga 35W, 6 razina glasnoće
- prikladan za ugradnju u kutije najmanje 60 mm dubine
- nije prikladan za ugradnju u kutije dubine 45 mm te podžbuknu ugradnju u kutije CUBO IP20
- samo za unutrašnju uporabu

VOLUME CONTROL 4-8 Ω 35W 2M

- volume control (attenuator) for low voltage outputs 4-8 Ω, 35W
- power rating 35W, 6 steps volume control
- suitable for boxes min. 60 mm deep
- not suitable for installation in 45 mm deep boxes and surface mount boxes CUBO IP20
- for indoor use only

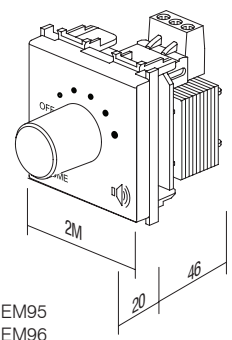

EM95
EM96



CM25

PW

OS

tip type	naziv description	tehnički podaci technical data	veličina size	boja colour	opsijski podaci 1 optional data 1
CM10	SET UTIČNICA 2X ŠUKO SOCKET SET 2x SCHUKO	2P+E 16A 250V~	4M	<input type="checkbox"/> PW bijela sjajna polar white	<input type="checkbox"/> OL okvir LINE cover plate LINE
CM11	SET UTIČNICA 3X ŠUKO SOCKET SET 3x SCHUKO	2P+E 16A 250V~	7M	<input checked="" type="checkbox"/> SB crna mat soft touch black	<input type="checkbox"/> OS okvir SOFT cover plate SOFT
CM15	SET SPOJNIH VODOVA LINK WIRE SET	3x1.5mm ²	1M	<input checked="" type="checkbox"/> AT antracit anthracite	
⋮	⋮	⋮	⋮	<input type="checkbox"/> ES srebrna mat elox silver	
⋮	⋮	⋮	⋮	<input type="checkbox"/> IW bež sjajna ivory white	

SET UTIČNICA 2x ŠUKO 2P+E 16A 250V~ 4M

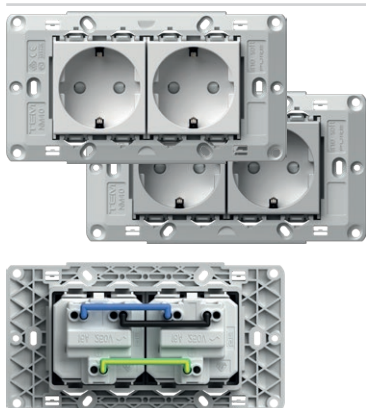

- CM10PW
- CM10ES

- set utičnica 2x šuko VM10 2P+E 16A 250V~
- utičnice povezane spojnim vodovima CM16
- s nosačem 4M bez vijaka
- za pričvršćivanje nosača vijci CM17, CM18 ili CM19
- vijčano pričvršćivanje vodiča presjeka 1,5-2,5 mm²
- sukladno normi IEC 60884-1, CEE7

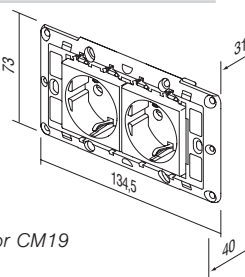

SOCKETS SET 2x SCHUKO 2P+E 16A 250V~ 4M

- socket set 2x schuko VM10 2P+E 16A 250V~
- prewired with link wires CM16
- with mounting frame 4M without screws
- for mounting frame fixing use screws CM17, CM18 or CM19
- screw contacts 1.5-2.5 mm²
- in accordance with IEC-60884-1, CEE7

SET UTIČNICA 3x ŠUKO 2P+E 16A 250V~ 7M

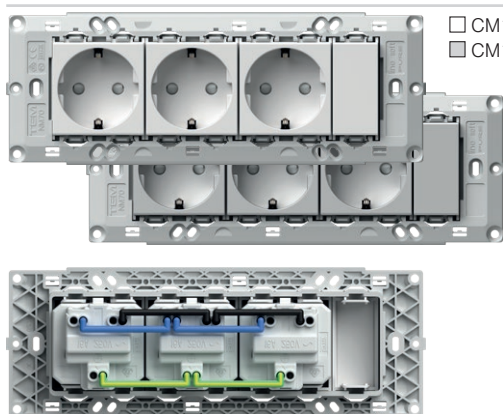

- CM11PW
- CM11ES

- set utičnica 3x šuko VM10 2P+E 16A 250V~
- utičnice povezane spojnim vodovima CM16
- s nosačem 7M bez vijaka
- za pričvršćivanje nosača vijci CM17, CM18 ili CM19
- vijčano pričvršćivanje vodiča presjeka 1,5-2,5 mm²
- sukladno normi IEC 60884-1, CEE7

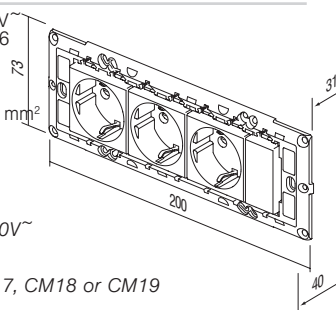

SOCKETS SET 3x SCHUKO 2P+E 16A 250V~ 7M

- socket set 3x schuko VM10 2P+E 16A 250V~
- prewired with link wires CM16
- with mounting frame 7M without screws
- for mounting frame fixing use screws CM17, CM18 or CM19
- screw contacts 1.5-2.5 mm²
- in accordance with IEC-60884-1, CEE7

SET SPOJNIH VODOVA 3x1,5mm² 1M



CM15

- set spojnih vodova za povezivanje dvaju elemenata veličine 1M
- sadrži 10 crnih, 10 plavih i 10 žuto-zelenih spojnih vodova

LINK WIRE SET 3x1.5mm² 1M

- link wire set to connect two elements size 1M
- includes 10 black, 10 blue and 10 yellow/green wires

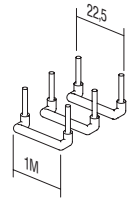

SET SPOJNIH VODOVA 3x2,5mm² 1M

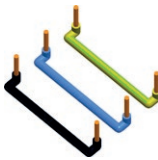

CM16

- set spojnih vodova za povezivanje dvaju elemenata veličine 2M
- sadrži 10 crnih, 10 plavih i 10 žuto-zelenih spojnih vodova

LINK WIRE SET 3x2.5mm² 2M

- link wire set to connect two elements size 2M
- includes 10 black, 10 blue and 10 yellow/green wires

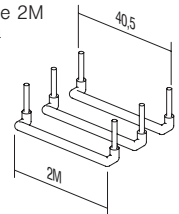

SET VIJAKA 3,5

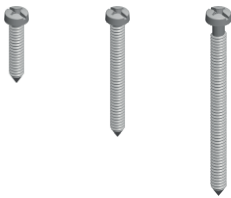

CM17
CM18
CM19

- set vijaka za pričvršćivanje nosača NM30, NM32, NM40, NM41, NM70
- CM17 - l=20 mm, 100 kom.
- CM18 - l=35 mm, 50 kom.
- CM19 - l=50 mm, 50 kom.

SCREW SET 3,5

- screw set for fixing mounting frames NM30, NM32, NM40, NM41, NM70
- CM17 - l=20mm, 100pcs
- CM18 - l=35mm, 50pcs
- CM19 - l=50mm, 50pcs

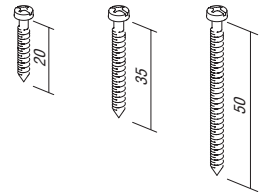

SET ZA SKLOPKE IP44 2M



CM22PW

- za ugradnju u vlažne prostore
- IP44 zaštita za sve Modul sklopke
- sklopke i tipke nisu sastavni dio seta
- okvir SOFT 2M s natpisnom pločicom
- sukladno normi IEC 60669-1

SET SWITCHES IP44 2M

- for usage in humid areas
- IP44 protection provides for all Modul switches
- switches and buttons are not part of the set
- SOFT 2M cover plate with inscription plate
- in accordance with IEC 60669-1



SET ZA UTIČNICU IP44 2M



CM23PW

- za ugradnju u vlažne prostore
- pruža IP44 zaštitu u kombinaciji s pokrivenom utičnicom (VM11, VM41)
- utičnice nisu sastavni dio seta
- okvir SOFT 2M s natpisnom pločicom
- sukladno normi IEC 60884-1

SET SOCKETS IP44 2M

- for usage in humid areas
- IP44 protection can be achieved only in combination with covered socket (VM11, VM41)
- sockets are not part of the set
- SOFT 2M cover plate with inscription plate
- in accordance with IEC 60884-1



KUPAONSKI SET 3x20A 250V~ 4M

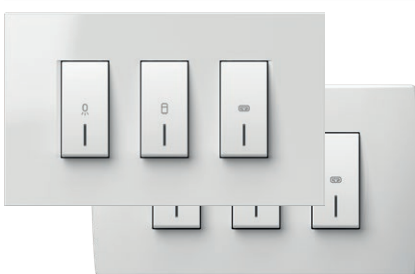

CM25PWOL
 CM25IWOL

 CM25PWOS
 CM25IWOS

- set sklopki 3xSM12 20A 250V~ s nosačem i okvirom
- vijčano pričvršćivanje vodiča presjeka 1,5-2 5mm²
- sukladno normi EN 60669-1
- univerzalno rješenje za pričvršćivanje na već ugrađene kutije s razmakom pričvršćivanja od 108 do 135 mm ili na kutije veličine 4M
- visina okvira 90 mm

SWITCH SET FOR BATHROOM 3x20A 250V~ 4M

- switch set 3xSM12 20A 250V~ with mounting frame and cover plate
- screw contacts 1.5-2.5mm²
- in accordance with EN 60669-1
- universal solution for renovation on boxes with fixing dimensions 108-135mm or boxes 4M size
- cover plate height 90mm

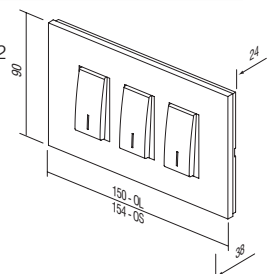

NOSAČI ZA KUPAONSKI SET 4M



NM41

- univerzalni nosač za kupaonski set s vijcima
- univerzalno rješenje za pričvršćivanje na pravokutne kutije s razmakom pričvršćivanja od 108 do 135 mm ili na kutije veličine 4M
- sukladno normi EN 60669-1





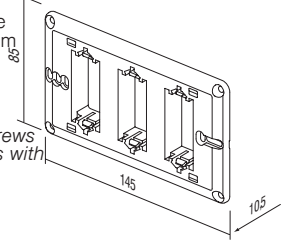

MOUNTING FRAME BATHROOM SET 4M

- universal mounting frame for bathroom set with screws
- universal solution for mounting on rectangular boxes with fixing dimensions 108-135mm or boxes 4M size
- in accordance with EN 60669-1



OKVIRI LINE ZA KUPAONSKI SET



-  OL41PW
-  OL41NB
-  OL41IW
-  OL41ES
-  OL41SG
-  OL41IB

- dekorativni okvir LINE za kupaonski set
- visina 90 mm
- sukladno normi EN 60669-1

COVER PLATE LINE BATHROOM SET

- decorative cover plate bathroom set LINE
- height 90mm
- in accordance with EN 60669-1

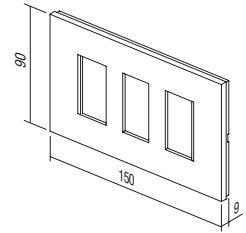

OKVIRI SOFT ZA KUPAONSKI SET



-  OS41PW
-  OS41NB
-  OS41IW
-  OS41ES
-  OS41SG
-  OS41SB
-  OS41WE

- dekorativni okvir SOFT za kupaonski set
- visina 90 mm
- sukladno normi EN 60669-1

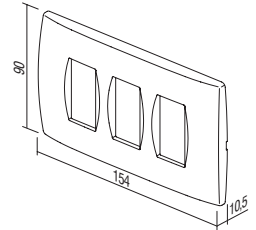

COVER PLATE SOFT BATHROOM SET

- decorative cover plate bathroom set SOFT
- height 90mm
- in accordance with EN 60669-1



S E T S C M



tip type	naziv description	veličina size	boja colour	opcijski podaci 1 optional data 1
TM11	TIPKA BUTTON	1M	<input type="checkbox"/> AW antibakterijska bijela antibacterial white	 NT neutralna neutral
TM21	SLIJEPI ELEMENT BLANK	1M		
VM10	UTIČNICA SOCKET	2M		 IN indikator indicator
.	.	.		
.	.	.		

ANTIBAKTERIJSKI PROGRAM MODUL

- brojne osobe svakodnevno dotiču sklopke i utičnice koje su stoga mjesta razvoja i širenja bakterija
- zahvaljujući prirodnim antibakterijskim svojstvima, srebro se tri tisuće godina koristi kao sigurno dezinfekcijsko sredstvo, jer je potpuno prirodan i neškodljiv materijal te ne zagađuje okoliš
- posebni antibakterijski ioni srebra pružaju dugotrajnu, pouzdanu i učinkovitu zaštitu od razvoja i širenja bakterija, virusa, mikroba i gljivica
- antibakterijska zaštita osigurava kvalitetnu higijenu, čistoću i zdravlje ljudima
- savršeno prikladan za korištenje u okruženjima koja zahtijevaju stroge higijenske uvjete (bolnice, zdravstveni centri, farmaceutska postrojenja, domovi za starije i nemoćne, domovi umirovljenika, laboratoriji, restorani, hoteli, zračne luke, autobusne i željezničke postaje, poslovni i trgovački prostori, javne institucije...)
- neovisni laboratoriji obavili su testiranja sukladno najvišim japanskim standardima JIS Z 2801
- niski troškovi osiguravanja ljudskog zdravlja
- dizajn i funkcionalnost antibakterijskog programa MODUL omogućava jednostavno čišćenje i održavanje
- antibakterijske tipke, okviri i utičnice kombinirani su sa standardnim ugradbenim okvirima i sklopkama
- proizvodi su označeni sa stražnje strane kao AB (antibakterijska bijela)

ANTIBACTERIAL PROGRAM MODUL

- switches and sockets are daily touched by many people, so this is a common place for development and spread of bacteria
- thanks to its natural antibacterial characteristics silver has been used for three millennia as a safe and effective disinfectant, since it is completely natural, healthy and environmentally friendly
- special antibacterial silver ions additive provides long-term, reliable and effective protection against the development and spread of bacteria, viruses, microbes and fungi
- antibacterial protection ensures hygiene, cleanliness and health for people
- perfectly suitable for use in environments with strict hygiene conditions (hospitals, health centers, pharmaceutical facilities, homes for elderly, nursing homes, laboratories, restaurants, hotels, airports, bus and railway stations, business and shopping areas, public institutions ...)
- independent laboratory testings have been carried out in accordance with highest Japanese standards JIS Z 2801
- low cost for providing human health
- design and functionality of antibacterial program MODUL allow easy cleaning and maintenance
- antibacterial buttons, cover plates and sockets are combined with classic mounting frames and switches
- products are labelled on the back with AW (antibacterial white)

TIPKA 1M



TM11AW

- zamjenjiva tipka 1M
- sukladno normi EN 60669-1
- antibakterijska zaštita usklađena s JIS Z 2801

BUTTON 1M

- replaceable button 1M
- in accordance with EN 60669-1
- antibacterial protection in accordance with JIS Z 2801



TIPKA 1M INDIKATOR



TM11AWIN

- zamjenjiva tipka 1M
- sukladno normi EN 60669-1
- antibakterijska zaštita usklađena s JIS Z 2801

BUTTON 1M INDICATOR

- replaceable button 1M
- in accordance with EN 60669-1
- antibacterial protection in accordance with JIS Z 2801



TIPKA 2M



TM12AW

- zamjenjiva tipka 2M s nosačem tipke
- upotrebljava se pri nadogradnji sklopke ili tipkala od veličine 1M na veličinu 2M
- sukladno normi EN 60669-1
- antibakterijska zaštita usklađena s JIS Z 2801

BUTTON 2M

- replaceable button 2M with button carrier
- to upgrade switch or push button from size 1M to size 2M
- in accordance with EN 60669-1
- antibacterial protection in accordance with JIS Z 2801



TIPKA 2M INDIKATOR



TM12AWIN

- zamjenjiva tipka 2M s nosačem tipke
- upotrebljava se pri nadogradnji sklopke ili tipkala od veličine 1M na veličinu 2M
- sukladno normi EN 60669-1
- antibakterijska zaštita usklađena s JIS Z 2801

BUTTON 2M INDICATOR

- replaceable button 2M with button carrier
- to upgrade switch or push button from size 1M to size 2M
- in accordance with EN 60669-1
- antibacterial protection in accordance with JIS Z 2801



SLIJEPI ELEMENT 1M



TM21AW

- slijepi element za popunjavanje praznog mjesta
- sukladno normi EN 60669-1
- antibakterijska zaštita usklađena s JIS Z 2801

BLANK 1M

- blank modul to fill up empty spaces
- in accordance with EN 60669-1
- antibacterial protection in accordance with JIS Z 2801



SLIJEPI ELEMENT 2M



TM22AW

- slijepi element za popunjavanje praznog mjesta
- sukladno normi EN 60669-1
- antibakterijska zaštita usklađena s JIS Z 2801

BLANK 2M

- blank modul to fill up empty spaces
- in accordance with EN 60669-1
- antibacterial protection in accordance with JIS Z 2801

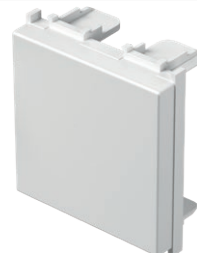



□ VM10AW

UTIČNICA ŠUKO+KS 2P+E 16A 250V~ 2M

- 2P+E šuko
- 16A 250V~, tip VM10
- sukladno normama IEC 60884-1, CEE7
- vijčano pričvršćivanje vodiča presjeka 1,5-2,5 mm²
- KS zaštita za djecu od dodira kontakta
- antibakterijska zaštita usklađena s JIS Z 2801

SOCKET SCHUKO+KS 2P+E 16A 250V~ 2M

- 2P+E schuko
- 16A 250V~, type VM10
- in accordance with IEC 60884-1, CEE7
- screw contacts 1.5-2.5 mm²
- KS build-in child protection - shuttered live contacts
- antibacterial protection in accordance with JIS Z 2801



□ VM11AW

UTIČNICA ŠUKO+KS +POKLOPAC 2P+E 16A 250V~ 2M

- 2P+E šuko+poklopac
- 16A 250V~, tip VM11
- sukladno normama IEC 60884-1, CEE7
- vijčano pričvršćivanje vodiča presjeka 1,5-2,5 mm²
- KS zaštita za djecu od dodira kontakta
- antibakterijska zaštita usklađena s JIS Z 2801

SOCKET SCHUKO+KS+COVER

- 2P+E schuko+cover
- 16A 250V~, type VM11
- in accordance with IEC 60884-1, CEE7
- screw contacts 1.5-2.5 mm²
- KS build-in child protection - shuttered live contacts
- antibacterial protection in accordance with JIS Z 2801



□ VM20AW

UTIČNICA EURO+KS 2P 10A 250V~ 1M

- 2P Euro
- 10A 250V~, tip VM20
- sukladno normama IEC 60884-1, CEE7
- vijčano pričvršćivanje vodiča presjeka 1,5-2,5 mm²
- KS zaštita za djecu od dodira kontakta
- antibakterijska zaštita usklađena s JIS Z 2801

SOCKET EURO+KS 2P 10A 250V~ 1M

- 2P Euro
- 10A 250V~, type VM20
- in accordance with IEC 60884-1, CEE7
- screw contacts 1.5-2.5 mm²
- KS build-in child protection - shuttered live contacts
- antibacterial protection in accordance with JIS Z 2801



□ KM11AW

UTIČNICA TV ZAVRŠNA 1dB 1M

- TV završna
- propušta frekvenciju u rasponu 5÷2400 MHz
- prigušenje < 1 dB
- sukladno normi EN 50083-1
- vijčano pričvršćivanje
- antibakterijska zaštita usklađena s JIS Z 2801

SOCKET TV END-LINE 1dB 1M

- TV end-line
- frequency range 5÷2400 MHz
- reduction < 1 dB
- in accordance with EN 50083-1
- screw contacts
- antibacterial protection in accordance with JIS Z 2801

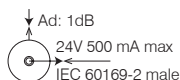

□ KM35AW

ADAPTER KS 1M

- KS keystone standard pričvršćivanja
- AMP, Avaya, Brandrex, FMT, Mfico, Tyco, ...
- nije ugraben komunikacijski modul
- antibakterijska zaštita usklađena s JIS Z 2801

ADAPTER KS 1M

- KS keystone fixing standard
- AMP, Avaya, Brandrex, FMT, Mfico, Tyco, ...
- communication module not included
- antibacterial protection in accordance with JIS Z 2801





OS20AW

OKVIR SOFT 2M

- dekorativni okvir SOFT 2M
- skladno normi EN 60669-1
- antibakterijska zaščita uskladenjena s JIS Z 2801

COVER PLATE SOFT 2M

- decorative cover plate SOFT 2M
- in accordance with EN 60669-1
- antibacterial protection in accordance with JIS Z 2801



OS24AW

OKVIR SOFT 2x2M

- dekorativni okvir SOFT 2x2M
- vodoravna ili okomita ugradnja
- skladno normi EN 60669-1
- antibakterijska zaščita uskladenjena s JIS Z 2801

COVER PLATE SOFT 2x2M

- decorative cover plate SOFT 2x2M
- horizontal or vertical mounting
- in accordance with EN 60669-1
- antibacterial protection in accordance with JIS Z 2801



OS26AW

OKVIR SOFT 3x2M

- dekorativni okvir SOFT 3x2M
- vodoravna ili okomita ugradnja
- skladno normi EN 60669-1
- antibakterijska zaščita uskladenjena s JIS Z 2801

COVER PLATE SOFT 3x2M

- decorative cover plate SOFT 3x2M
- horizontal or vertical mounting
- in accordance with EN 60669-1
- antibacterial protection in accordance with JIS Z 2801



OS30AW

OKVIR SOFT 3M

- dekorativni okvir SOFT 3M
- antibakterijska zaščita uskladenjena s JIS Z 2801
- skladno normi EN 60669-1

COVER PLATE SOFT 3M

- decorative cover plate SOFT 3M
- in accordance with EN 60669-1
- antibacterial protection in accordance with JIS Z 2801

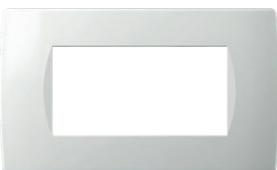

OS40AW

OKVIR SOFT 4M

- dekorativni okvir SOFT 4M
- skladno normi EN 60669-1
- antibakterijska zaščita uskladenjena s JIS Z 2801

COVER PLATE SOFT 4M

- decorative cover plate SOFT 4M
- in accordance with EN 60669-1
- antibacterial protection in accordance with JIS Z 2801

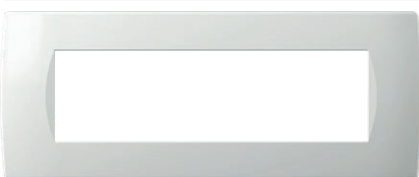

OS70AW

OKVIR SOFT 7M

- dekorativni okvir SOFT 7M
- skladno normi EN 60669-1
- antibakterijska zaščita uskladenjena s JIS Z 2801

COVER PLATE SOFT 7M

- decorative cover plate SOFT 7M
- in accordance with EN 60669-1
- antibacterial protection in accordance with JIS Z 2801

drvo
wood

WB bambus
bamboo



WW orah
walnut



WM javor
maple



WE wenge
wenge



Priroda je jedinstvena i dragocjena, baš kao i naši okviri, među kojima ne postoje dva ista.
Reklamacije zbog različitosti izgleda i međusobne raznolikosti drvenih okvira ne uvažavamo.

Nature is unique and precious, as our decorative cover plates where no two are the same.
Complaints about wooden decorative cover plate's diverse appearance and differentiation cannot be considered.

C O V E R P L A T E S P U R E O P

metal
metal

MH kovani čelik
hammered steel



ME lijevano željezo
etched iron



MS satenski srebrna
satin silver

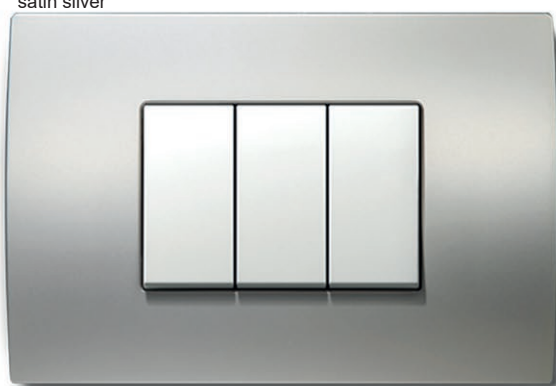

MN satenski poniklani
satin nickel

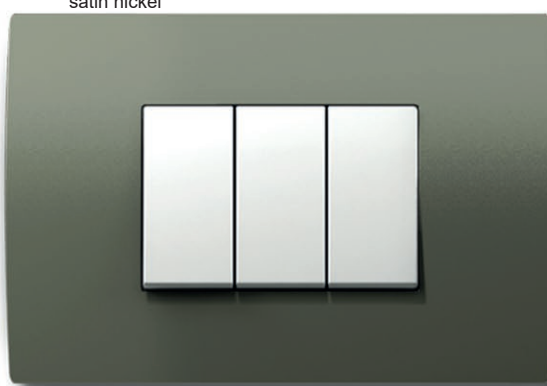

staklo
glass

GW ledeno bijela
ice white

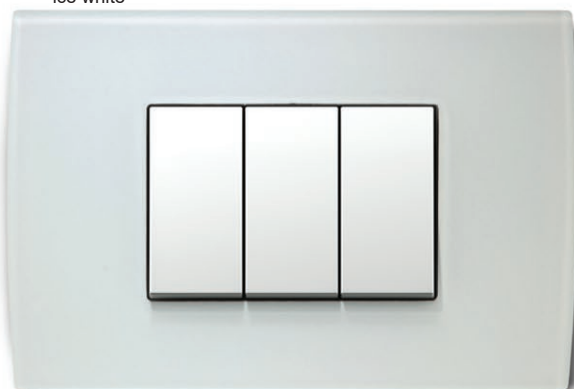

GG ledeno zelena
ice green

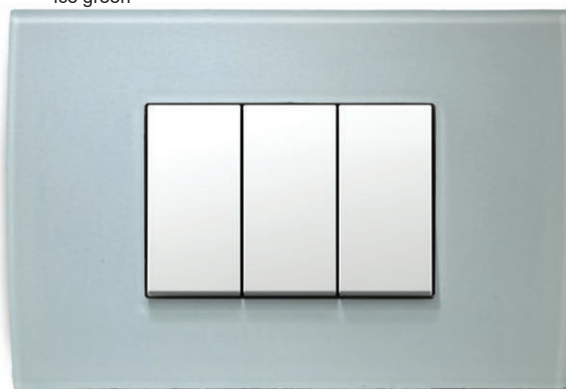

GY ledeno siva
ice grey

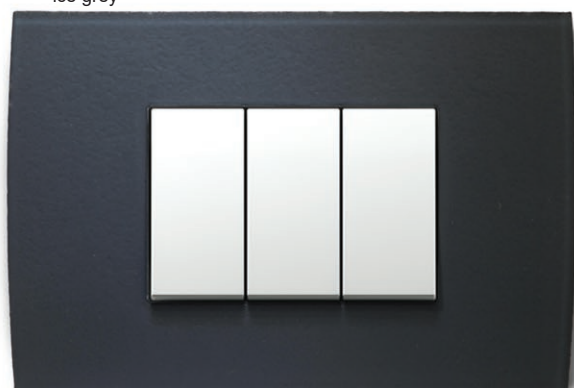

GB ledeno plava
ice blue

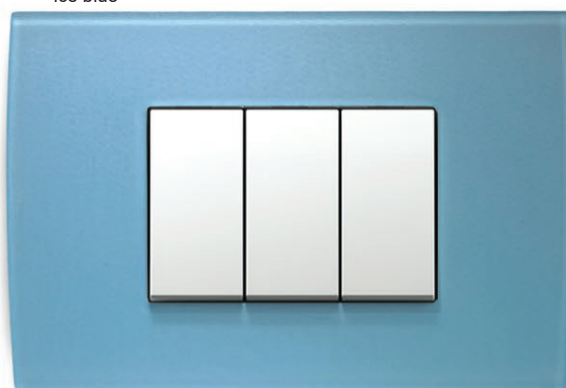



tip type	naziv description	veličina size	boja colour	
OP13	OKVIR PURE COVER PLATE PURE	1/3M	MH kovani čelik hammered steel	WB bambus bamboo
OP20	OKVIR PURE COVER PLATE PURE	2M	ME lijevano željezo etched iron	WW orah walnut
OP23	OKVIR PURE COVER PLATE PURE	2/3M	MS satenski srebrna satin silver	WM javor maple
.	.	.	MN satenski poniklani satin nickel	WE wenge wenge
.	.	.		GW ledeno bijela ice white
.	.	.		GG ledeno zelena ice green
.	.	.		GY ledeno siva ice grey
.	.	.		GB ledeno plava ice blue



OP20MH	OP20WB
OP20ME	OP20WW
OP20MS	OP20WM
OP20MN	OP20WE
	OP20GW
	OP20GG
	OP20GY
	OP20GB

OKVIR PURE 2M

- dekorativni okvir PURE 2M
- sukladno normi EN 60669-1
- samo u kombinaciji s nosačem NM24 ili NM25

COVER PLATE PURE 2M

- decorative cover plate PURE 2M
- in accordance with EN 60669-1
- only in combination with mounting frames NM24 or NM25

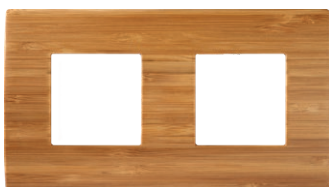

OP24MH	OP24WB
OP24ME	OP24WW
OP24MS	OP24WM
OP24MN	OP24WE
	OP24GW
	OP24GG
	OP24GY
	OP24GB

OKVIR PURE 2x2M

- dekorativni okvir PURE 2x2M
- vodoravna ili okomita ugradnja
- sukladno normi EN 60669-1
- samo u kombinaciji s nosačem NM24 ili NM25

COVER PLATE PURE 2x2M

- decorative cover plate PURE 2x2M
- horizontal or vertical mounting
- in accordance with EN 60669-1
- only in combination with mounting frames NM24 or NM25



OP26MH	OP26WB
OP26ME	OP26WW
OP26MS	OP26WM
OP26MN	OP26WE
	OP26GW
	OP26GG
	OP26GY
	OP26GB

OKVIR PURE 3x2M

- dekorativni okvir PURE 3x2M
- vodoravna ili okomita ugradnja
- sukladno normi EN 60669-1
- samo u kombinaciji s nosačem NM24 ili NM25

COVER PLATE PURE 3x2M

- decorative cover plate PURE 3x2M
- horizontal or vertical mounting
- in accordance with EN 60669-1
- only in combination with mounting frames NM24 or NM25

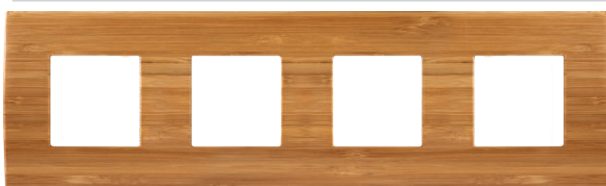

OP28MH	OP28WB
OP28ME	OP28WW
OP28MS	OP28WM
OP28MN	OP28WE
	OP28GW
	OP28GG
	OP28GY
	OP28GB

OKVIR PURE 4x2M

- dekorativni okvir PURE 4x2M
- vodoravna ili okomita ugradnja
- sukladno normi EN 60669-1
- samo u kombinaciji s nosačem NM24 ili NM25

COVER PLATE PURE 4x2M

- decorative cover plate PURE 4x2M
- horizontal or vertical mounting
- in accordance with EN 60669-1
- only in combination with mounting frames NM24 or NM25

C O V E R P L A T E S P U R E O P



OP30MH	OP30WB
OP30ME	OP30WW
OP30MS	OP30WM
OP30MN	OP30WE
	OP30GW
	OP30GG
	OP30GY
	OP30GB

OKVIR PURE 3M

- dekorativni okvir PURE 3M
- skladno normi EN 60669-1

COVER PLATE PURE 3M

- decorative cover plate PURE 3M
- in accordance with EN 60669-1



OP40MH	OP40WB
OP40ME	OP40WW
OP40MS	OP40WM
OP40MN	OP40WE
	OP40GW
	OP40GG
	OP40GY
	OP40GB

OKVIR PURE 4M

- dekorativni okvir PURE 4M
- skladno normi EN 60669-1

COVER PLATE PURE 4M

- decorative cover plate PURE 4M
- in accordance with EN 60669-1



OP70MH	OP70WB
OP70ME	OP70WW
OP70MS	OP70WM
OP70MN	OP70WE
	OP70GW
	OP70GG
	OP70GY
	OP70GB

OKVIR PURE 7M

- dekorativni okvir PURE 7M
- skladno normi EN 60669-1

COVER PLATE PURE 7M

- decorative cover plate PURE 7M
- in accordance with EN 60669-1



OP13MH	OP13WB
OP13ME	OP13WW
OP13MS	OP13WM
OP13MN	OP13WE
	OP13GW
	OP13GG
	OP13GY
	OP13GB

OKVIR PURE 1/3M

- dekorativni okvir PURE 1/3M
- skladno normi EN 60669-1

COVER PLATE PURE 1/3M

- decorative cover plate PURE 1/3M
- in accordance with EN 60669-1



OP23MH	OP23WB
OP23ME	OP23WW
OP23MS	OP23WM
OP23MN	OP23WE
	OP23GW
	OP23GG
	OP23GY
	OP23GB

OKVIR PURE 2/3M

- dekorativni okvir PURE 2/3M
- skladno normi EN 60669-1

COVER PLATE PURE 2/3M

- decorative cover plate PURE 2/3M
- in accordance with EN 60669-1

osnovni
basic

PW bijela sjajna
polar white

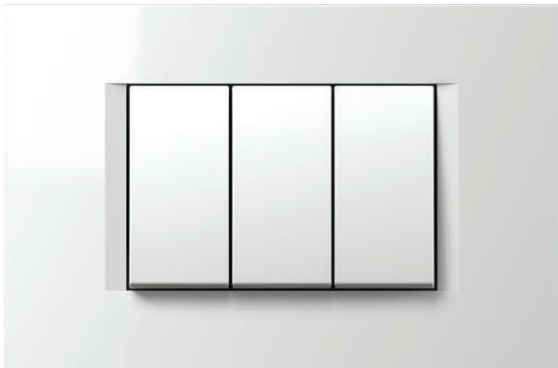

IW bež sjajna
ivory white

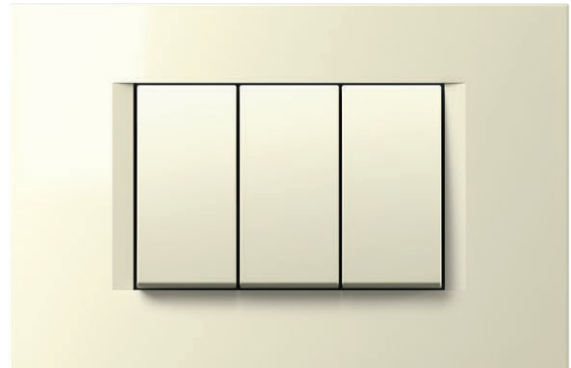

ES srebrna mat
elox silver



SB crna mat
soft touch black

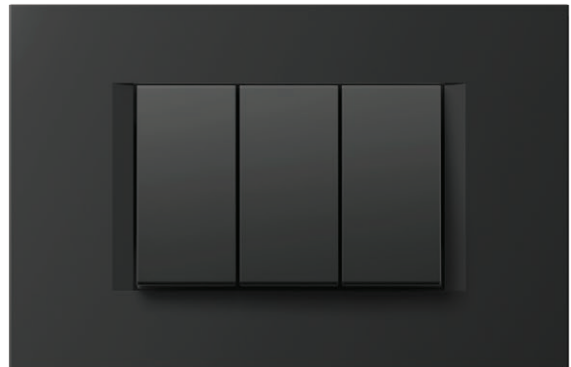

C O V E R P L A T E S L I N E O L

dekor
decor

SG zlatna mat
sand gold

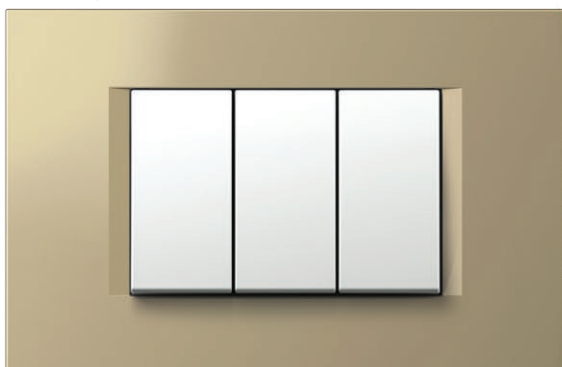

NB crna sjajna
night black

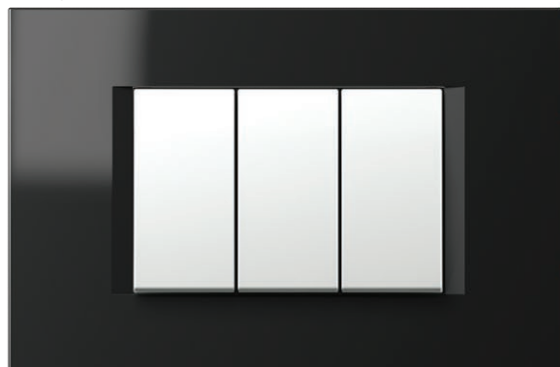

IB plava mat
impulse blue

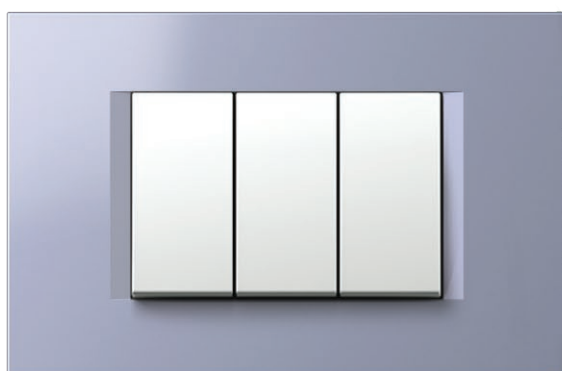

AT antracit
anthracite

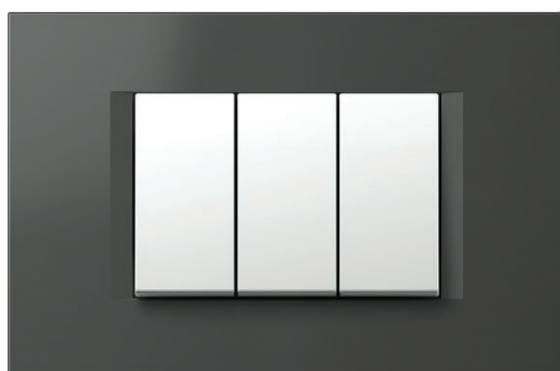

TI titan
titanium



SW kamen bijeli
stone white



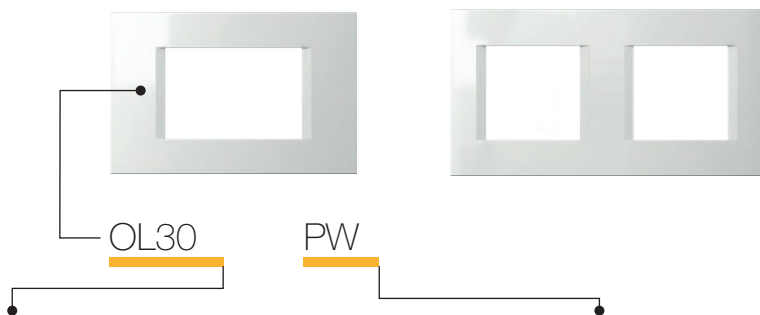

tip type	naziv description	veličina size	boja colour												
OL10	OKVIR LINE COVER PLATE LINE	1/2M	<table border="0"> <tr> <td></td> <td>PW bijela sjajna polar white</td> <td></td> <td>SG zlatna mat sand gold</td> <td></td> <td>AT antracit anthracite</td> </tr> </table>		PW bijela sjajna polar white		SG zlatna mat sand gold		AT antracit anthracite						
	PW bijela sjajna polar white		SG zlatna mat sand gold		AT antracit anthracite										
OL13	OKVIR LINE COVER PLATE LINE	1/3M	<table border="0"> <tr> <td></td> <td>IW bež sjajna ivory white</td> <td></td> <td>NB crna sjajna night black</td> <td></td> <td>TI titan titanium</td> </tr> </table>		IW bež sjajna ivory white		NB crna sjajna night black		TI titan titanium						
	IW bež sjajna ivory white		NB crna sjajna night black		TI titan titanium										
OL20	OKVIR LINE COVER PLATE LINE	2M	<table border="0"> <tr> <td></td> <td>ES srebrna mat elox silver</td> <td></td> <td>IB plava mat impulse blue</td> <td></td> <td>SW kamen bijeli stone white</td> </tr> <tr> <td></td> <td>SB crna mat soft touch black</td> <td></td> <td></td> <td></td> <td></td> </tr> </table>		ES srebrna mat elox silver		IB plava mat impulse blue		SW kamen bijeli stone white		SB crna mat soft touch black				
	ES srebrna mat elox silver		IB plava mat impulse blue		SW kamen bijeli stone white										
	SB crna mat soft touch black														
:	:	:													
:	:	:													



OKVIR LINE 2M

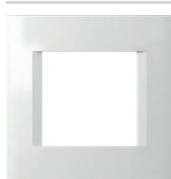

	OL20PW		OL20SG
	OL20IW		OL20NB
	OL20ES		OL20IB
	OL20SB		OL20AT
			OL20TI
			OL20SW

- dekorativni okvir LINE 2M
 - sukladno normi EN 60669-1
COVER PLATE LINE 2M
 - decorative cover plate LINE 2M
 - in accordance with EN 60669-1

OKVIR LINE 2x2M



	OL24PW		OL24SG
	OL24IW		OL24NB
	OL24ES		OL24IB
	OL24SB		OL24AT
			OL24TI
			OL24SW

- dekorativni okvir LINE 2x2M
 - vodoravna ili okomita ugradnja
 - sukladno normi EN 60669-1
COVER PLATE LINE 2x2M
 - decorative cover plate LINE 2x2M
 - horizontal or vertical mounting
 - in accordance with EN 60669-1

OKVIR LINE 3x2M

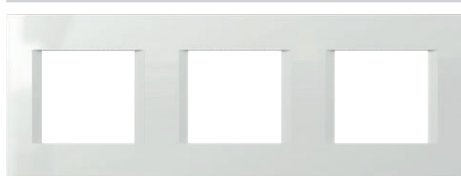

	OL26PW		OL26SG
	OL26IW		OL26NB
	OL26ES		OL26IB
	OL26SB		OL26AT
			OL26TI
			OL26SW

- dekorativni okvir LINE 3x2M
 - vodoravna ili okomita ugradnja
 - sukladno normi EN 60669-1
COVER PLATE LINE 3x2M
 - decorative cover plate LINE 3x2M
 - horizontal or vertical mounting
 - in accordance with EN 60669-1

OKVIR LINE 4x2M



	OL28PW		OL28SG
	OL28IW		OL28NB
	OL28ES		OL28IB
	OL28SB		OL28AT
			OL28TI
			OL28SW

- dekorativni okvir LINE 4x2M
 - vodoravna ili okomita ugradnja
 - sukladno normi EN 60669-1
COVER PLATE LINE 4x2M
 - decorative cover plate LINE 4x2M
 - horizontal or vertical mounting
 - in accordance with EN 60669-1

OKVIR LINE 5x2M

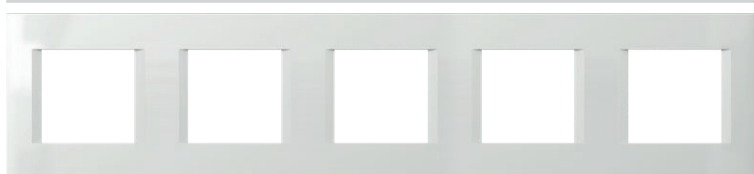

	OL29PW
	OL29IW
	OL29ES
	OL29SB
	OL29AT
	OL29TI

- dekorativni okvir LINE 5x2M
 - vodoravna ili okomita ugradnja
 - sukladno normi EN 60669-1
COVER PLATE LINE 5x2M
 - decorative cover plate LINE 5x2M
 - horizontal or vertical mounting
 - in accordance with EN 60669-1

C O V E R P L A T E S L I N E O L



	OL30PW		OL30SG
	OL30IW		OL30NB
	OL30ES		OL30IB
	OL30SB		OL30AT
			OL30TI
			OL30SW

OKVIR LINE 3M

- dekorativni okvir LINE 3M
- skladno normi EN 60669-1

COVER PLATE LINE 3M
- decorative cover plate LINE 3M
- in accordance with EN 60669-1

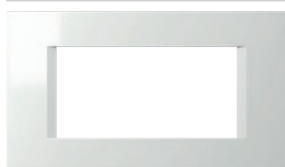

	OL40PW		OL40SG
	OL40IW		OL40NB
	OL40ES		OL40IB
	OL40SB		OL40AT
			OL40TI
			OL40SW

OKVIR LINE 4M

- dekorativni okvir LINE 4M
- skladno normi EN 60669-1

COVER PLATE LINE 4M
- decorative cover plate LINE 4M
- in accordance with EN 60669-1

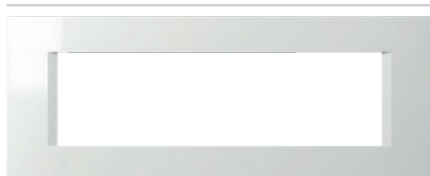

	OL70PW		OL70SG
	OL70IW		OL70NB
	OL70ES		OL70IB
	OL70SB		OL70AT
			OL70TI
			OL70SW

OKVIR LINE 7M

- dekorativni okvir LINE 7M
- skladno normi EN 60669-1

COVER PLATE LINE 7M
- decorative cover plate LINE 7M
- in accordance with EN 60669-1



	OL10PW		OL10SG
	OL10IW		OL10NB
	OL10ES		OL10IB
	OL10SB		OL10AT
			OL10TI
			OL10SW

OKVIR LINE 1/2M

- dekorativni okvir LINE 1/2M
- skladno normi EN 60669-1

COVER PLATE LINE 1/2M
- decorative cover plate LINE 1/2M
- in accordance with EN 60669-1

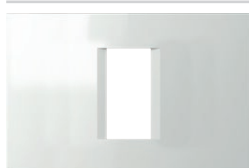

	OL13PW		OL13SG
	OL13IW		OL13NB
	OL13ES		OL13IB
	OL13SB		OL13AT
			OL13TI
			OL13SW

OKVIR LINE 1/3M

- dekorativni okvir LINE 1/3M
- skladno normi EN 60669-1

COVER PLATE LINE 1/3M
- decorative cover plate LINE 1/3M
- in accordance with EN 60669-1

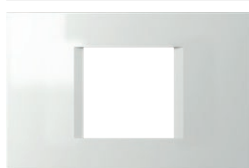

	OL23PW		OL23SG
	OL23IW		OL23NB
	OL23ES		OL23IB
	OL23SB		OL23AT
			OL23TI
			OL23SW

OKVIR LINE 2/3M

- dekorativni okvir LINE 2/3M
- skladno normi EN 60669-1

COVER PLATE LINE 2/3M
- decorative cover plate LINE 2/3M
- in accordance with EN 60669-1

osnovni
basic

PW bijela sjajna
polar white

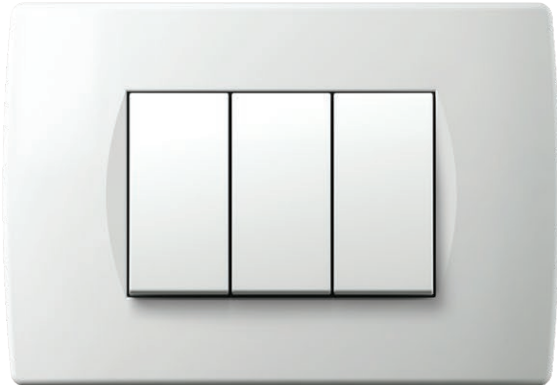

IW bež sjajna
ivory white

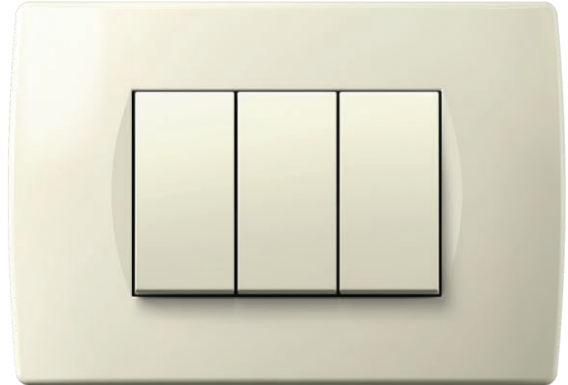

ES srebrna mat
elox silver

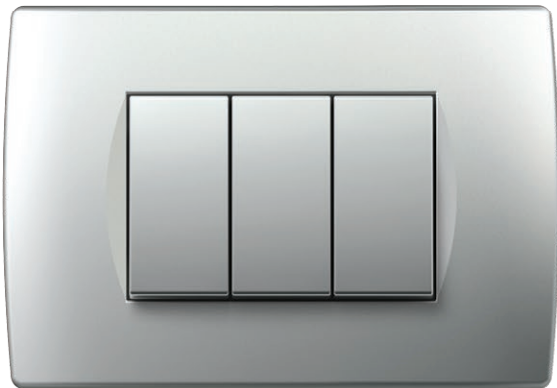

SB crna mat
soft touch black



C O V E R P L A T E S S O F T O S

dekor
decor

SG zlatna mat
sand gold

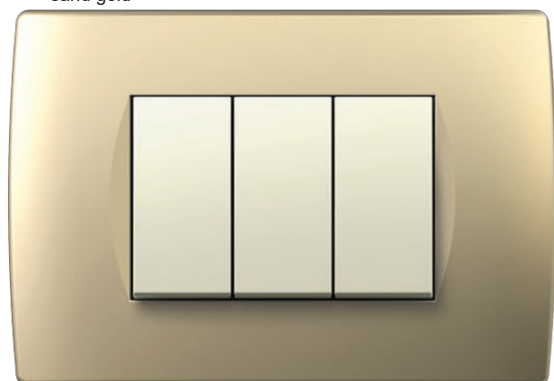

NB crna sjajna
night black

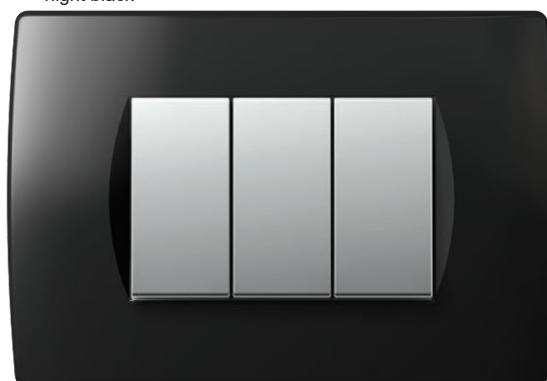

AT antracit
anthracite

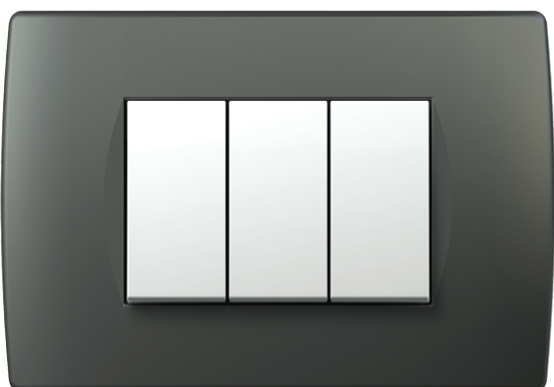

TI titan
titanium

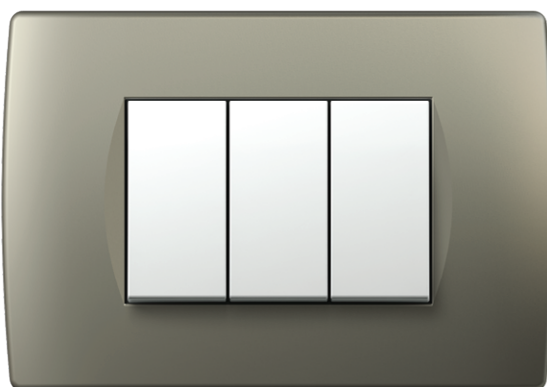

WE wenge
wenge



WW orah
walnut



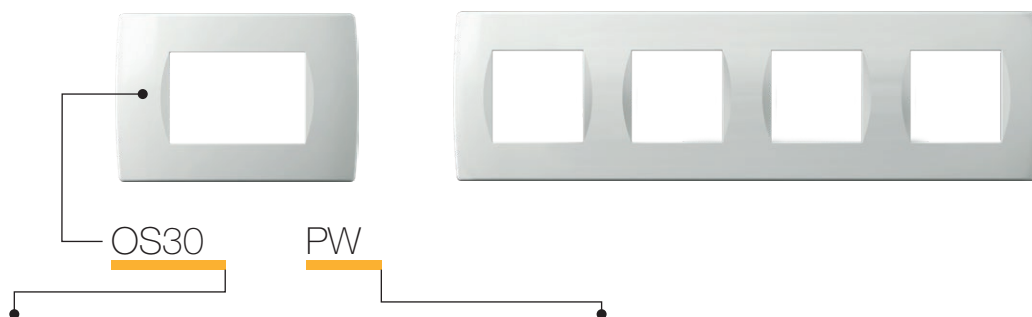

tip type	naziv description	veličina size	boja colour												
OS10	OKVIR SOFT COVER PLATE SOFT	1/2M	<table border="0"> <tr> <td></td> <td>PW bijela sjajna polar white</td> <td></td> <td>SG zlatna mat sand gold</td> <td></td> <td>WW orah walnut</td> </tr> </table>		PW bijela sjajna polar white		SG zlatna mat sand gold		WW orah walnut						
	PW bijela sjajna polar white		SG zlatna mat sand gold		WW orah walnut										
OS13	OKVIR SOFT COVER PLATE SOFT	1/3M	<table border="0"> <tr> <td></td> <td>IW bež sjajna ivory white</td> <td></td> <td>NB crna sjajna night black</td> <td></td> <td>WE wenge wenge</td> </tr> </table>		IW bež sjajna ivory white		NB crna sjajna night black		WE wenge wenge						
	IW bež sjajna ivory white		NB crna sjajna night black		WE wenge wenge										
OS20	OKVIR SOFT COVER PLATE SOFT	2M	<table border="0"> <tr> <td></td> <td>ES srebrna mat elox silver</td> <td></td> <td>AT antracit anthracite</td> <td></td> <td></td> </tr> <tr> <td></td> <td>SB crna mat soft touch black</td> <td></td> <td>TI titan titanium</td> <td></td> <td></td> </tr> </table>		ES srebrna mat elox silver		AT antracit anthracite				SB crna mat soft touch black		TI titan titanium		
	ES srebrna mat elox silver		AT antracit anthracite												
	SB crna mat soft touch black		TI titan titanium												
...												



	OS20PW		OS20SG
	OS20IW		OS20NB
	OS20ES		OS20AT
	OS20SB		OS20TI
			OS20WW
			OS20WE

OKVIR SOFT 2M

- dekorativni okvir SOFT 2M
- sukladno normi EN 60669-1

COVER PLATE SOFT 2M

- decorative cover plate SOFT 2M
- in accordance with EN 60669-1



	OS24PW		OS24SG
	OS24IW		OS24NB
	OS24ES		OS24AT
	OS24SB		OS24TI
			OS24WW
			OS24WE

OKVIR SOFT 2x2M

- dekorativni okvir SOFT 2x2M
- vodoravna ili okomita ugradnja
- sukladno normi EN 60669-1

COVER PLATE SOFT 2x2M

- decorative cover plate SOFT 2x2M
- horizontal or vertical mounting
- in accordance with EN 60669-1

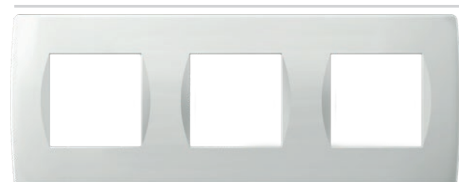

	OS26PW		OS26SG
	OS26IW		OS26NB
	OS26ES		OS26AT
	OS26SB		OS26TI
			OS26WW
			OS26WE

OKVIR SOFT 3x2M

- dekorativni okvir SOFT 3x2M
- vodoravna ili okomita ugradnja
- sukladno normi EN 60669-1

COVER PLATE SOFT 3x2M

- decorative cover plate SOFT 3x2M
- horizontal or vertical mounting
- in accordance with EN 60669-1



	OS28PW		OS28SG
	OS28IW		OS28NB
	OS28ES		OS28AT
	OS28SB		OS28TI
			OS28WW
			OS28WE

OKVIR SOFT 4x2M

- dekorativni okvir SOFT 4x2M
- vodoravna ili okomita ugradnja
- sukladno normi EN 60669-1

COVER PLATE SOFT 4x2M

- decorative cover plate SOFT 4x2M
- horizontal or vertical mounting
- in accordance with EN 60669-1

C O V E R P L A T E S S O F T O S



 OS30PW	 OS30SG
 OS30IW	 OS30NB
 OS30ES	 OS30AT
 OS30SB	 OS30TI
	 OS30WW
	 OS30WE











OKVIR SOFT 3M

- dekorativni okvir SOFT 3M
- sukladno normi EN 60669-1

COVER PLATE SOFT 3M

- decorative cover plate SOFT 3M
- in accordance with EN 60669-1



 OS40PW	 OS40SG
 OS40IW	 OS40NB
 OS40ES	 OS40AT
 OS40SB	 OS40TI
	 OS40WW
	 OS40WE









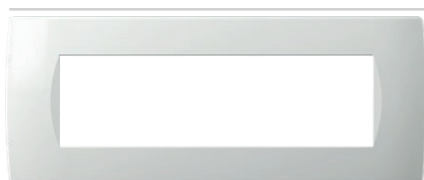

OKVIR SOFT 4M

- dekorativni okvir SOFT 4M
- sukladno normi EN 60669-1

COVER PLATE SOFT 4M

- decorative cover plate SOFT 4M
- in accordance with EN 60669-1



 OS70PW	 OS70SG
 OS70IW	 OS70NB
 OS70ES	 OS70AT
 OS70SB	 OS70TI
	 OS70WW
	 OS70WE







OKVIR SOFT 7M

- dekorativni okvir SOFT 7M
- sukladno normi EN 60669-1

COVER PLATE SOFT 7M

- decorative cover plate SOFT 7M
- in accordance with EN 60669-1



 OS72PW	 OS72AT
 OS72IW	 OS72TI
 OS72ES	
 OS72SB	

OKVIR SOFT 2x7M

- dekorativni okvir SOFT 2x7M s
natpisnom pločicom
- sukladno normi EN 60669-1

COVER PLATE SOFT 2x7M

- decorative cover plate SOFT 2x7M
with inscription plate
- in accordance with EN 60669-1



 OS10PW	 OS10SG
 OS10IW	 OS10NB
 OS10ES	 OS10AT
 OS10SB	 OS10TI
	 OS10WW
	 OS10WE









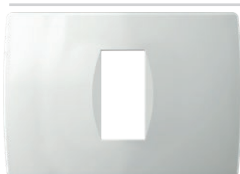

OKVIR SOFT 1/2M

- dekorativni okvir SOFT 1/2M
- sukladno normi EN 60669-1

COVER PLATE SOFT 1/2M

- decorative cover plate SOFT 1/2M
- in accordance with EN 60669-1



 OS13PW	 OS13SG
 OS13IW	 OS13NB
 OS13ES	 OS13AT
 OS13SB	 OS13TI
	 OS13WW
	 OS13WE

OKVIR SOFT 1/3M

- dekorativni okvir SOFT 1/3M
- sukladno normi EN 60669-1

COVER PLATE SOFT 1/3M

- decorative cover plate SOFT 1/3M
- in accordance with EN 60669-1

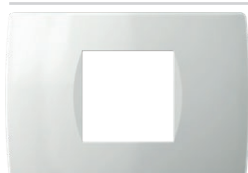

 OS23PW	 OS23SG
 OS23IW	 OS23NB
 OS23ES	 OS23AT
 OS23SB	 OS23TI
	 OS23WW
	 OS23WE

OKVIR SOFT 2/3M

- dekorativni okvir SOFT 2/3M
- sukladno normi EN 60669-1

COVER PLATE SOFT 2/3M

- decorative cover plate SOFT 2/3M
- in accordance with EN 60669-1

LASERSKO GRAVIRANJE NA OKVIRIMA



- lasersko graviranje proizvoljne grafike
- izrada po narudžbi
- prikladno za okvire OL, OS

LASER PRINT ON COVER PLATES

- laser print of any graphics
- made on request
- suitable for cover plates OL, OS

UKRAŠAVANJE OKVIRA









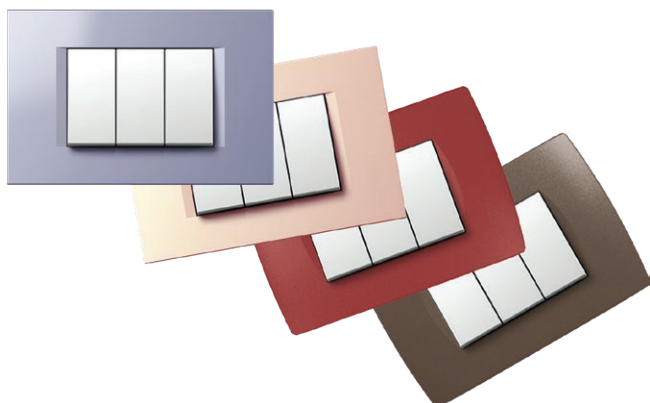

- tekstura i boje po želji kupca
- izrada po narudžbi
- prikladno za okvire OL, OS

COVER PLATES DECORATIONS

- customised textures and colours
- made on request
- suitable for cover plates OL, OS

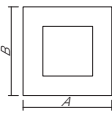
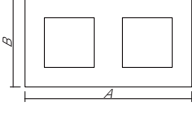
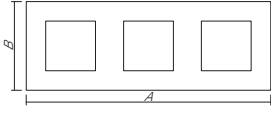
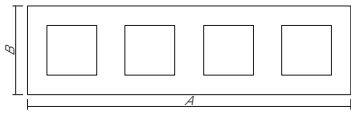

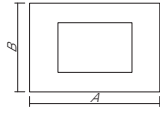
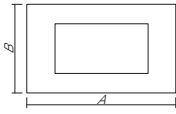
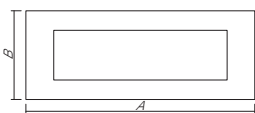
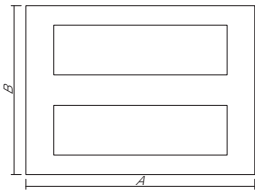
F R A M E S

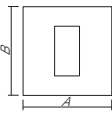
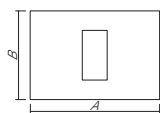
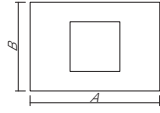
	 line A x B	 soft A x B	 PURE A x B
2M 	80 x 80 mm	84 x 84 mm	93 x 90 mm
2x2M 	151 x 80 mm	155 x 84 mm	164 x 90 mm
3x2M 	222 x 80 mm	226 x 84 mm	235 x 90 mm
4x2M 	293 x 80 mm	297 x 84 mm	304 x 90 mm
			
3M 	122 x 80 mm	122 x 84 mm	134 x 90 mm
4M 	149 x 80 mm	144 x 84 mm	157 x 90 mm
7M 	207 x 80 mm	212 x 84 mm	224 x 90 mm
2x7M 		212 x 158 mm	
			
1/2M 	80 x 80 mm	84 x 84 mm	
1/3M 	122 x 80 mm	122 x 84 mm	134 x 90 mm
2/3M 	122 x 80 mm	122 x 84 mm	134 x 90 mm

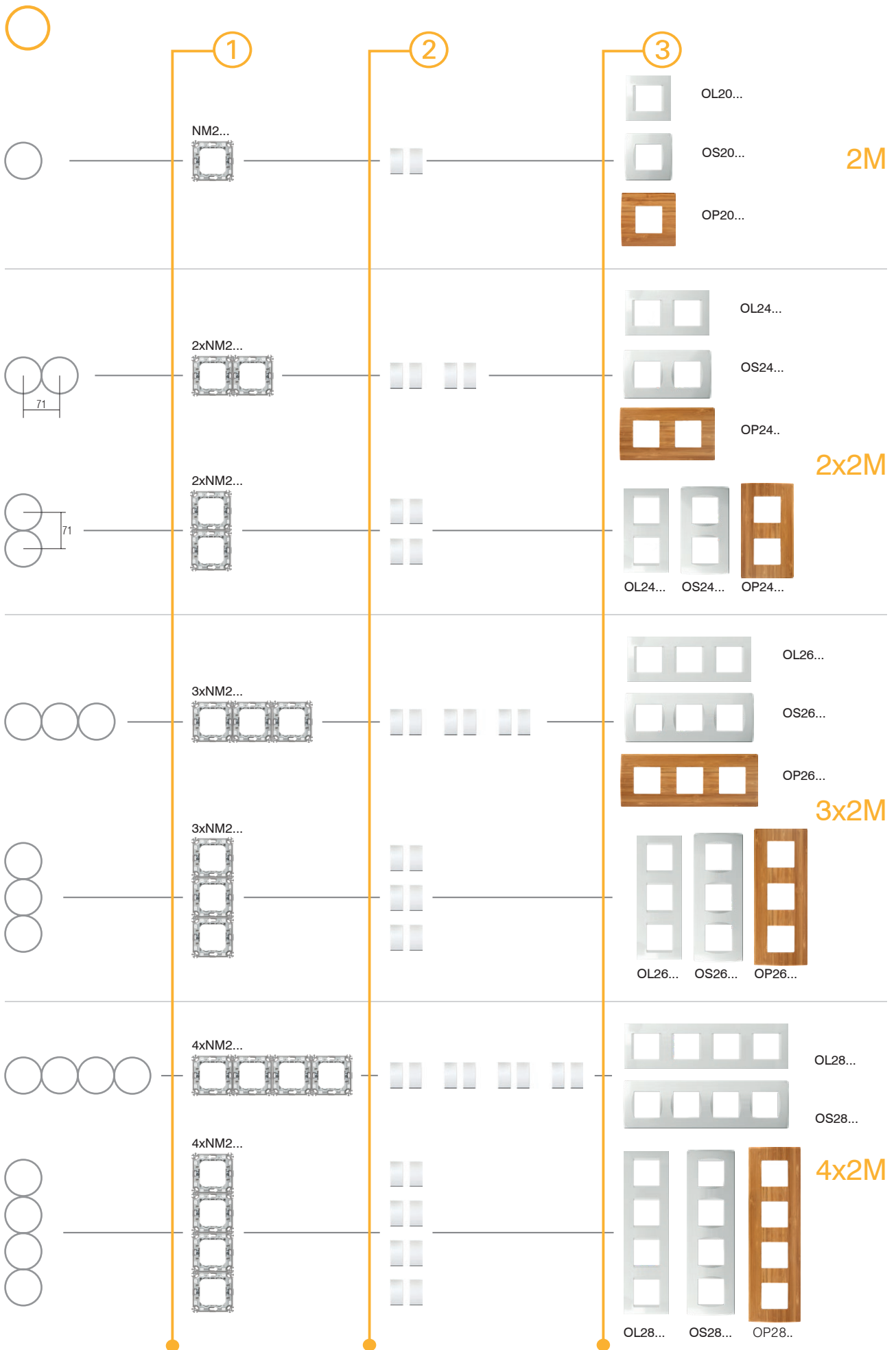

COMBINATIONS

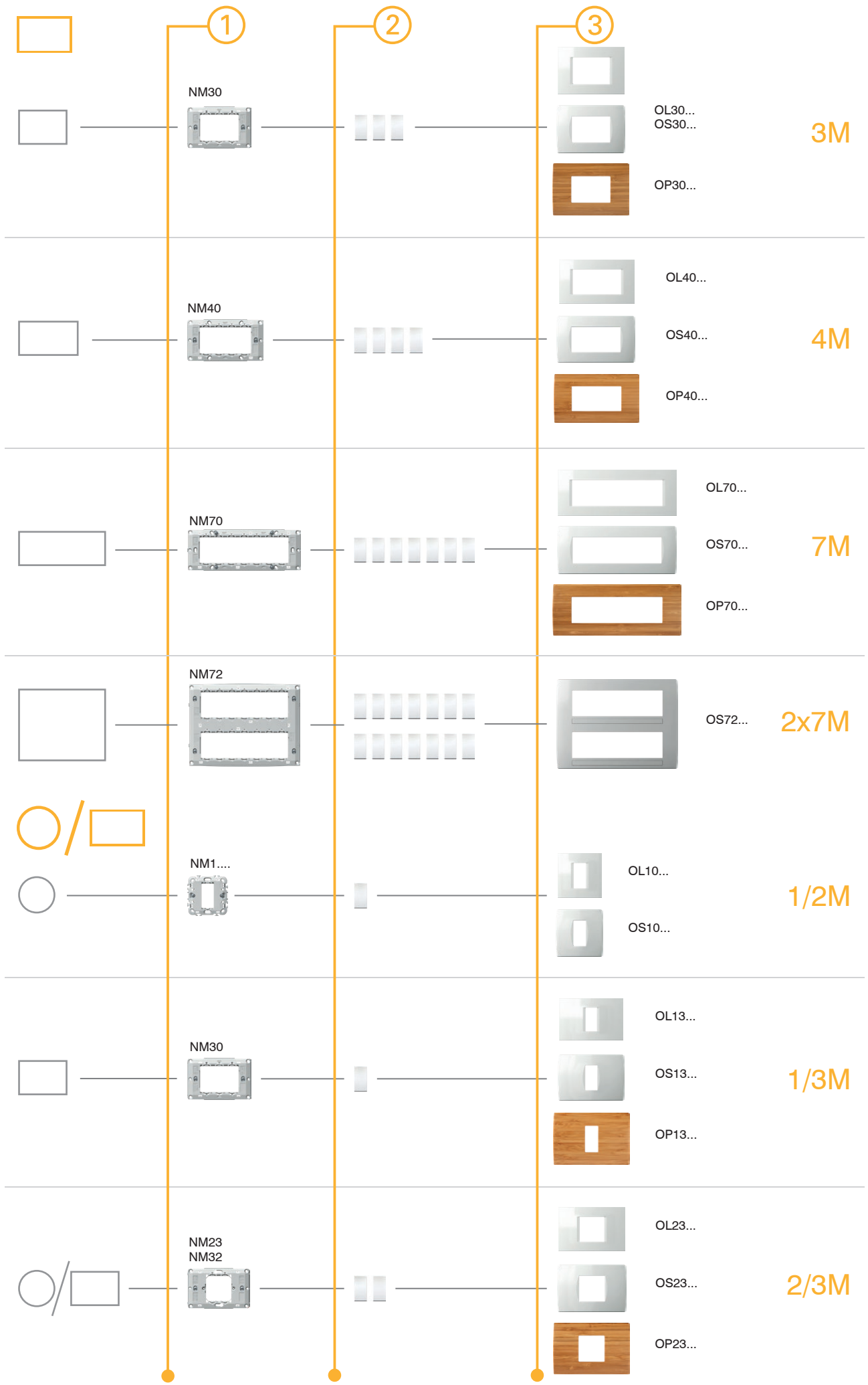

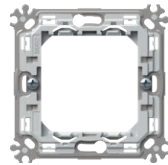

NM30

tip type	naziv description	veličina size
NM10	NOSAČ S NOŽICAMA MOUNTING FRAME WITH CLAWS	1/2M
NM11	NOSAČ BEZ VIJAKA MOUNTING FRAME WITHOUT SCREWS	1/2M
NM20	NOSAČ S NOŽICAMA MOUNTING FRAME WITH CLAWS	2M
...



NOSAČ S NOŽICAMA 2M

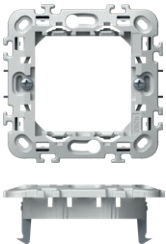

NM20

- nosač s nožicama 2M
- za ugradnju u kutije Ø60 (DE..) s nožicama
- moguće kombinacije vodoravne ili okomite ugradnje 2x2M, 3x2M i 4x2M
- prikladno za kombiniranje s okvirima LINE i SOFT
- sukladno normi EN 60669-1

MOUNTING FRAME WITH CLAWS 2M

- mounting frame 2M with claws
- for mounting on boxes Ø60 (DE..) with claws
- possible horizontal or vertical combinations 2x2M, 3x2M and 4x2M
- suitable for assembling with cover plates LINE and SOFT
- in accordance with EN 60669-1

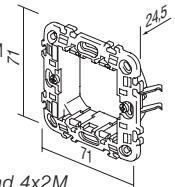

NOSAČ BEZ VIJAKA 2M

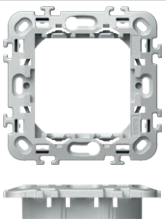

NM21

- nosač 2M bez vijaka i bez nožica
- za ugradnju u kutije Ø60 (HE.., BE..) s vijcima
- moguće kombinacije vodoravne ili okomite ugradnje 2x2M, 3x2M i 4x2M
- prikladno za kombiniranje s okvirima LINE i SOFT
- sukladno normi EN 60669-1

MOUNTING FRAME WITHOUT SCREWS 2M

- mounting frame 2M without screws and without claws
- for mounting on boxes Ø60 (HE.., BE..) with screws
- possible horizontal or vertical combinations 2x2M, 3x2M and 4x2M
- suitable for assembling with cover plates LINE and SOFT
- in accordance with EN 60669-1

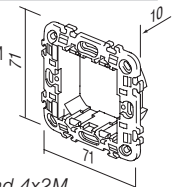

NOSAČ METALNI S NOŽICAMA 2M

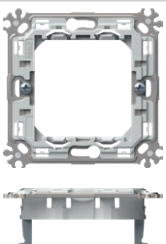

NM24

- metalni nosač 2M s nožicama - kruta inačica
- za ugradnju u kutije Ø60 (DE..) s nožicama
- moguće kombinacije vodoravne ili okomite ugradnje 2x2M, 3x2M i 4x2M
- prikladno za kombiniranje s okvirima PURE, LINE i SOFT
- sukladno normi EN 60669-1

MOUNTING FRAME METAL WITH CLAWS 2M

- metal mounting frame 2M with claws - stiff version
- for mounting on boxes Ø60 (DE..) with claws
- possible horizontal or vertical combinations 2x2M, 3x2M and 4x2M
- suitable for assembling with cover plates PURE, LINE and SOFT
- in accordance with EN 60669-1

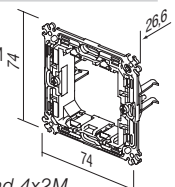

NOSAČ METALNI BEZ VIJAKA 2M

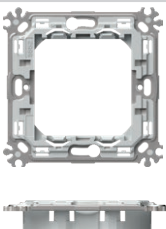

NM25

- metalni nosač 2M bez vijaka i bez nožica - kruta inačica
- za ugradnju u kutije Ø 60 (HE..., BE...) s vijcima
- moguće kombinacije vodoravne ili okomite ugradnje 2x2M, 3x2M i 4x2M
- prikladno za kombiniranje s okvirima PURE, LINE i SOFT
- sukladno normi EN 60669-1

MOUNTING FRAME METAL WITHOUT SCREWS 2M

- metal mounting frame 2M without screws and without claws - stiff version
- for mounting in boxes Ø60 (HE..., BE...) with screws
- possible horizontal or vertical combinations 2x2M, 3x2M and 4x2M
- suitable for assembling with cover plates PURE, LINE and SOFT
- in accordance with EN 60669-1

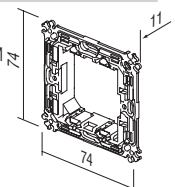

M O U N T I N G F R A M E S N M

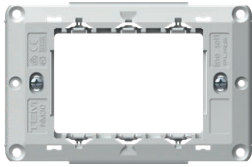

NM30

NOSAČ S VIJCIMA 3M

- nosač 3M s vijcima
- za ugradnju u pravokutne kutije 3M
- prikladno za kombiniranje s okvirima PURE, LINE i SOFT
- sukladno normi EN 60669-1

MOUNTING FRAME WITH SCREWS 3M

- mounting frame 3M with screws
- for mounting on rectangular boxes 3M
- suitable for assembling with cover plates PURE, LINE and SOFT
- in accordance with EN 60669-1

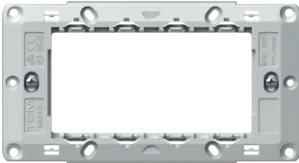
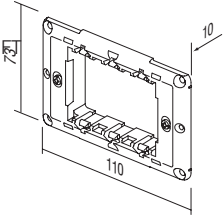

NM40

NOSAČ S VIJCIMA 4M

- nosač 4M s vijcima
- za ugradnju u pravokutne kutije 4M
- prikladno za kombiniranje s okvirima PURE, LINE i SOFT
- sukladno normi EN 60669-1

MOUNTING FRAME WITH SCREWS 4M

- mounting frame 4M with screws
- for mounting on rectangular boxes 4M
- suitable for assembling with cover plates PURE, LINE and SOFT
- in accordance with EN 60669-1

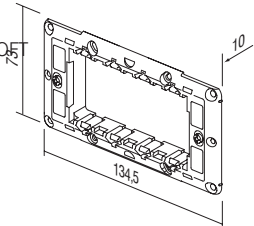

NM70

NOSAČ S VIJCIMA 7M

- nosač 7M s vijcima
- za ugradnju u pravokutne kutije 7M
- prikladno za kombiniranje s okvirima PURE, LINE i SOFT
- sukladno normi EN 60669-1

MOUNTING FRAME WITH SCREWS 7M

- mounting frame 7M with screws
- for mounting on rectangular boxes 7M
- suitable for assembling with cover plates PURE, LINE and SOFT
- in accordance with EN 60669-1

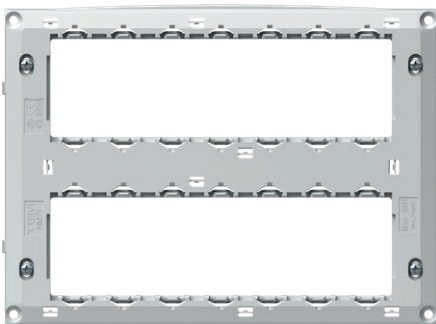
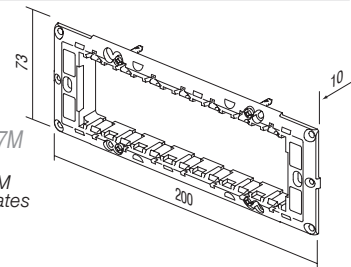

NM72

NOSAČ S VIJCIMA 2x7M

- nosač 2x7M s vijcima
- za ugradnju u pravokutne kutije 2x7M
- prikladan za sastavljanje s okvirom SOFT OS72
- sukladno normi EN 60669-1

MOUNTING FRAME WITH SCREWS 2x7M

- mounting frame 2x7M with screws
- for mounting on rectangular boxes 2x7M
- suitable for assembling with cover plate SOFT OS72
- in accordance with EN 60669-1

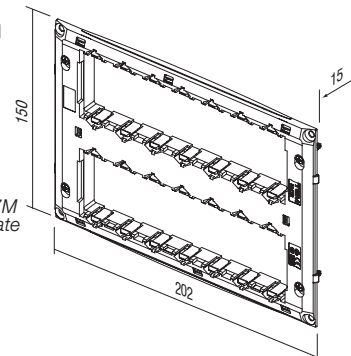



	<p>NM10</p>	<p>NOSAČ S NOŽICAMA 1/2M</p> <ul style="list-style-type: none"> - nosač 1/2M s nožicama - za ugradnju u kutije Ø60 (DE..) s nožicama - prikladno za kombiniranje s okvirima LINE i SOFT - sukladno normi EN 60669-1 <p><i>MOUNTING FRAME WITH CLAWS 1/2M</i></p> <ul style="list-style-type: none"> - mounting frame 1/2M with claws - for mounting on boxes Ø60 (DE..) with claws - suitable for assembling with cover plates LINE and SOFT - in accordance with EN 60669-1 	
	<p>NM11</p>	<p>NOSAČ BEZ VIJAKA 1/2M</p> <ul style="list-style-type: none"> - nosač 1/2M bez vijaka i bez nožica - za ugradnju u kutije Ø60 (HE.., BE..) s vijcima - prikladno za kombiniranje s okvirima LINE i SOFT - sukladno normi EN 60669-1 <p><i>MOUNTING FRAME WITHOUT SCREWS 1/2M</i></p> <ul style="list-style-type: none"> - mounting frame 1/2M without screws and without claws - for mounting on boxes Ø60 (HE.., BE..) with screws - suitable for assembling with cover plates LINE and SOFT - in accordance with EN 60669-1 	
	<p>NM23</p>	<p>NOSAČ S NOŽICAMA 2/3M</p> <ul style="list-style-type: none"> - nosač 2/3M s nožicama - za ugradnju u kutije Ø60 (DE..) s nožicama - prikladno za kombiniranje s okvirima PURE, LINE i SOFT - sukladno normi EN 60669-1 <p><i>MOUNTING FRAME WITH CLAWS 2/3M</i></p> <ul style="list-style-type: none"> - mounting frame 2/3M with claws - for mounting on boxes Ø60 (DE..) with claws - suitable for assembling with cover plates PURE, LINE and SOFT - in accordance with EN 60669-1 	
	<p>NM32</p>	<p>NOSAČ S VIJCIMA 2/3M</p> <ul style="list-style-type: none"> - nosač 2/3M s vijcima - za ugradnju u pravokutne kutije 3M - prikladno za kombiniranje s okvirima PURE, LINE i SOFT - sukladno normi EN 60669-1 <p><i>MOUNTING FRAME WITH SCREWS 2/3M</i></p> <ul style="list-style-type: none"> - mounting frame 2/3M with screws - for mounting on rectangular boxes 3M - suitable for assembling with cover plates PURE, LINE and SOFT - in accordance with EN 60669-1 	

M O U N T I N G F R A M E S N M

TEM

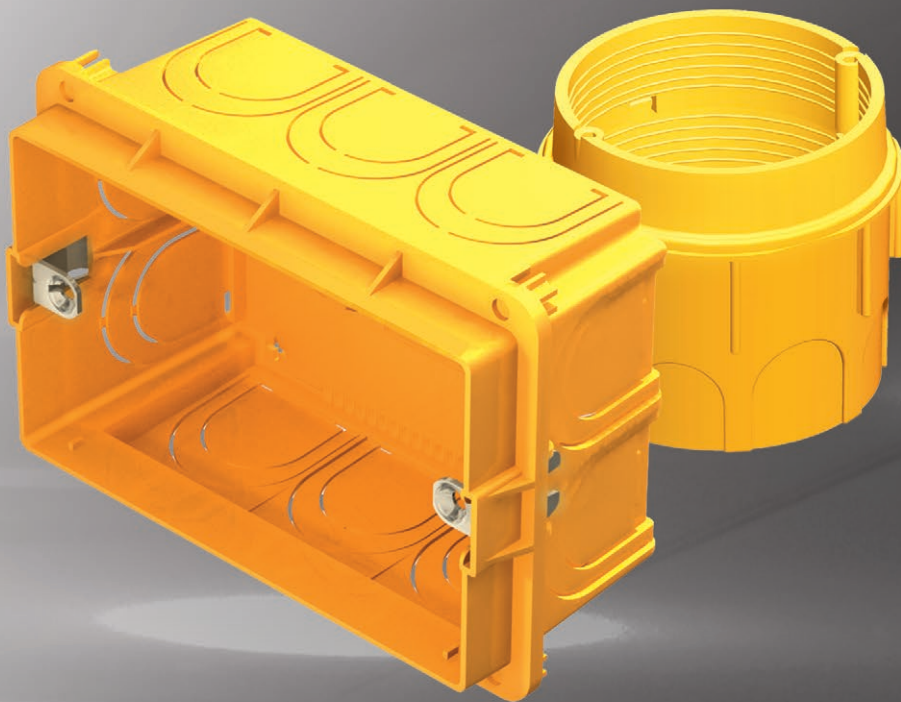



KUTIJE OKRUGLE
ROUND BOXES



140

KUTIJE PRAVOKUTNE
RECTANGULAR BOXES



148

KUTIJE PRIKLJUČNE
JUNCTION BOXES



156

PRIBOR ZA OŽIČENJE
WIRING ACCESSORIES



158



DE12



HE11



BE10

tip type	naziv description	veličina size
DE10	KUTIJA OKRUGLA ZA ZID OD OPEKE ROUND BOX BRICK	SM60-01
HE10	KUTIJA OKRUGLA ZA ŠUPLJE ZIDOVE ROUND BOX HOLLOW WALL	SM68X40
BE10	KUTIJA OKRUGLA ZA BETON ROUND BOX CONCRETE	
:	:	:
:	:	:

KUTIJA OKRUGLA ZA ZID OD OPEKE SM60-01



DE10

- Ø60, dubina 40mm
- 650°C, 500V
- sukladno normi IEC 60670-1
- bez halogena

ROUND BOX BRICK SM60-01

- Ø60, depth 40mm
- 650°C, 500V
- in accordance with IEC 60670-1
- halogen free

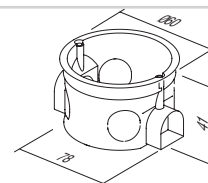

KUTIJA OKRUGLA ZA ZID OD OPEKE DUBOKA SM60-06



DE11

- Ø60, dubina 60mm
- 650°C, 500V
- sukladno normi IEC 60670-1
- bez halogena

ROUND BOX BRICK DEEP SM60-06

- Ø60, depth 60mm
- 650°C, 500V
- in accordance with IEC 60670-1
- halogen free

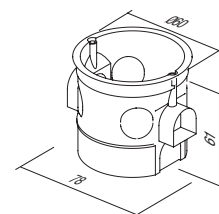

VEZNI ČLAN SM60-03



DE30

- za okomito povezivanje kutija SM60-06 ili SM60-01 na razmaku od 91 mm
- sukladno normi IEC 60670-1
- bez halogena

COMBI-CLIP SM60-03

- for vertical fitting of boxes SM60-06 or SM60-01 on distance 91 mm
- in accordance with IEC 60670-1
- halogen free

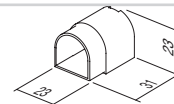

VEZNI ČLAN SM60-04

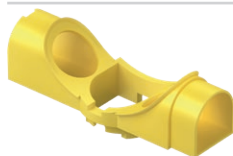

DE31

- za vodoravno povezivanje kutija SM60-06 ili SM60-01 na razmaku od 71 mm
- sukladno normi IEC 60670-1
- bez halogena

COMBI-CLIP SM60-04

- for horizontal fitting of boxes SM60-06 or SM60-01 on distance 71mm
- in accordance with IEC 60670-1
- halogen free

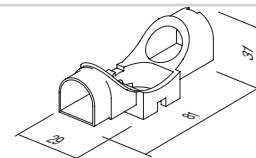

KUTIJA OKRUGLA ZA ZID OD OPEKE MD65-46



DE12

- Ø65, dubina 46mm
- 650°C, 500V
- sukladno normi IEC 60670-1
- bez halogena

ROUND BOX BRICK MD65-46

- Ø65, depth 46mm
- 650°C, 500V
- in accordance with IEC 60670-1
- halogen free

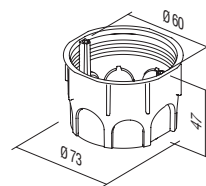

KUTIJA OKRUGLA ZA ZID OD OPEKE DUBOKA MD65-60



DE13

- Ø65/60, dubina 62mm
- 650°C, 500V
- sukladno normi IEC 60670-1
- bez halogena

ROUND BOX BRICK DEEP MD65-60

- Ø65/60, depth 62mm
- 650°C, 500V
- in accordance with IEC 60670-1
- halogen free

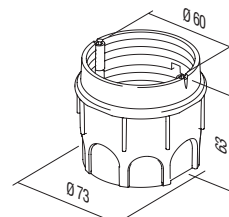

PRODUŽETAK ZA MD65-46



DE14

- Ø65/60, dubina 17mm
- 650°C, 500V
- sukladno normi IEC 60670-1
- bez halogena

ADDITIONAL PIECE FOR MD65-46

- Ø65/60, depth 17mm
- 650°C, 500V
- in accordance with IEC 60670-1
- halogen free

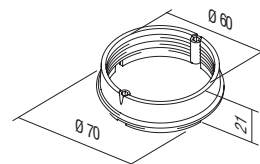

VEZNI ČLAN MD65-71



DE32

- za povezivanje kutija MD65 na razmaku od 71mm
- sukladno normi IEC 60670-1
- bez halogena

COMBI-CLIP MD65-71

- for fitting of boxes MD65 on distance 71mm
- in accordance with IEC 60670-1
- halogen free

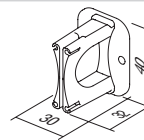

VEZNI ČLAN MD65-91



DE33

- za povezivanje kutija MD65 na razmaku od 91mm
- sukladno normi IEC 60670-1
- bez halogena

COMBI-CLIP MD65-91

- for fitting of boxes MD65 on distance 91mm
- in accordance with IEC 60670-1
- halogen free

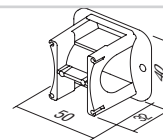

POKLOPAC KUTIJE ZAŠTITNI 60



DE20

- zaštitni poklopac za kutiju Ø60 za DE10, DE11, DE13, DE14
- sukladno normi IEC 60670-1
- zaštita kutije tijekom žbukanja

BOX COVER PROTECTIVE 60

- protective cover for box Ø60 for DE10, DE11, DE13, DE14
- in accordance with IEC 60670-1
- box protection during plastering

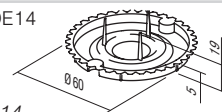

POKLOPAC KUTIJE ZAŠTITNI 65



DE21

- zaštitni poklopac za kutiju Ø65 za DE12
- sukladno normi IEC 60670-1
- zaštita kutije tijekom žbukanja

BOX COVER PROTECTIVE 65

- protective cover for box Ø65 for DE12
- in accordance with IEC 60670-1
- box protection during plastering

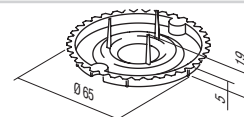

POKLOPAC KUTIJE DEKORATIVNI SM60



DE22

- dekorativni poklopac za kutije Ø60
- sukladno normi IEC 60670-1
- bez halogena

BOX COVER DECORATIVE SM60

- decorative cover for boxes Ø60
- in accordance with IEC 60670-1
- halogen free

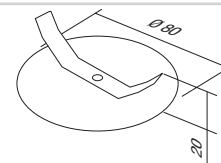



cigla / brick

upute za ugradnju /
assembly instructions

razmak između kutija /
distance between boxes: 71 mm

razmak između kutija /
distance between boxes: 91 mm

DE10,11

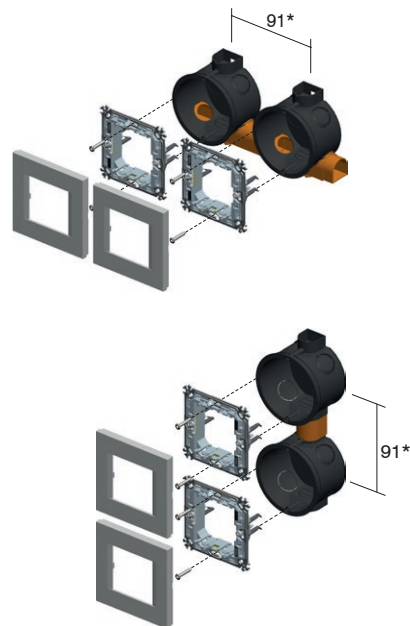
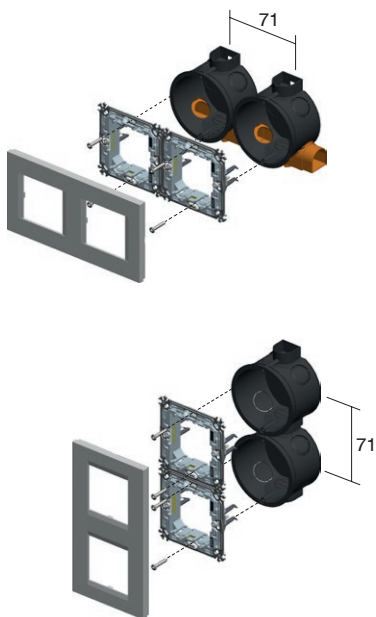
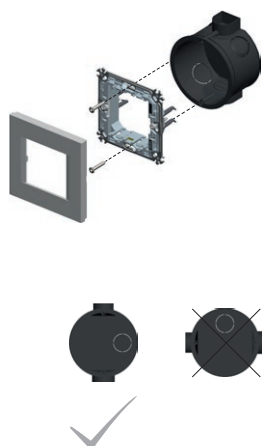

DE12,13

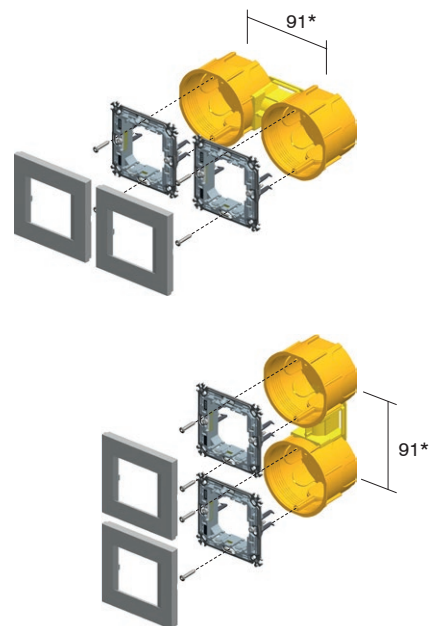
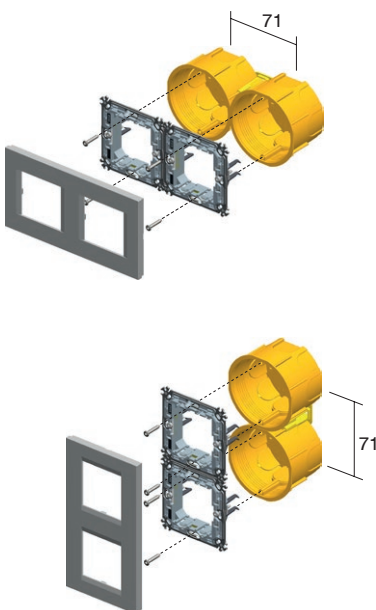
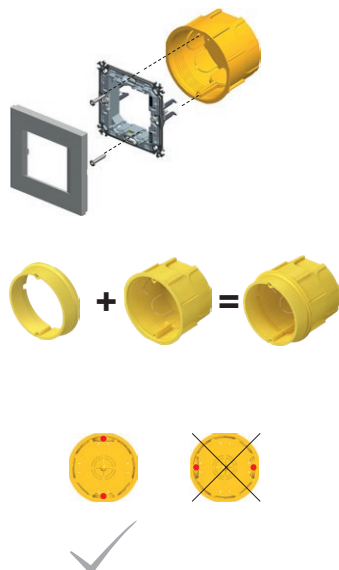

* za okvire PURE, min. razmak između kutija je 100 mm

* for PURE cover plates the minimum distance between boxes is 100mm

R O U N D B O X E S



DE10,11



DE12,13



NM20



NM24



DE10,11



DE12,13



NM10



71

2xDE10,11 + 2xDE31



2xNM20



2xDE12,13 + 1xDE32



2xNM24



2xDE10,11 2xDE12,13 + 1xDE32

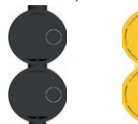

2xNM20



2xNM24



DE10,11



DE12,13



NM23



3xDE10,11 + 3xDE31



3xNM20



3xDE12,13 + 2xDE32



3xNM24



3xDE10,11 3xDE12,13 + 2xDE32

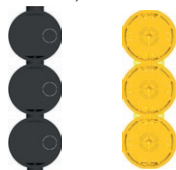

3xNM20



3xNM24



4xDE10,11 + 4xDE31



4xNM20



4xDE12,13 + 3xDE32



4xNM24



4xDE10,11 4xDE12,13 + 3xDE32

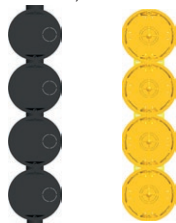

4xNM20



4xNM24





HE10

KUTIJA OKRUGLA ZA ŠUPLJE ZIDOVE SM68x40

- Ø60, dubina 40mm
- ugradni promjer Ø68
- 850°C, 400V~
- sukladno normi IEC 60670-1
- ugradnja s nožicama
- bez halogena

ROUND BOX HOLLOW WALL SM68x40

- Ø60, depth 40mm
- cutting hole Ø68
- 850°C, 400V~
- in accordance with IEC 60670-1
- mounting with claws
- halogen free

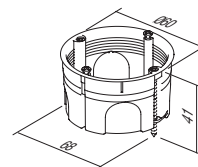

HE11

KUTIJA OKRUGLA ZA ŠUPLJE ZIDOVE SM68x55

- Ø60, dubina 55mm
- ugradni promjer Ø68
- 850°C, 400V~
- sukladno normi IEC 60670-1
- ugradnja s nožicama
- bez halogena

ROUND BOX HOLLOW WALL SM68x55

- Ø60, depth 55mm
- cutting hole Ø68
- 850°C, 400V~
- in accordance with IEC 60670-1
- mounting with claws
- halogen free

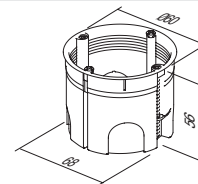

BE10

KUTIJA OKRUGLA ZA BETON

- Ø60 mm, dubina 49 mm
- 650°C, 500V~
- sukladno normi IEC 60670-1
- bez halogena

ROUND BOX CONCRETE

- Ø60mm, depth 49mm
- 650°C, 500V~
- in accordance with IEC 60670-1
- halogen free

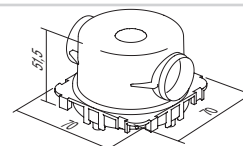

BE11

KUTIJA OKRUGLA ZA BETON DUBOKA

- Ø60 mm, dubina 58mm
- 650°C, 500V~
- sukladno normi IEC 60670-1
- bez halogena

ROUND BOX CONCRETE DEEP

- Ø60mm, depth 58mm
- 650°C, 500V~
- in accordance with IEC 60670-1
- halogen free

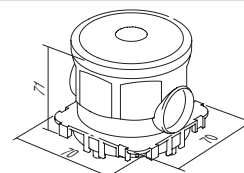

BE20

NOSAČ KUTIJE ZA BETON

- za učvršćivanje doze dilatacijskim profilom BM82 u suprotni zid
- sukladno normi IEC 60670-1
- bez halogena

COUNTER BOX SUPPORT CONCRETE

- to support concrete boxes with discance profile BM82 for extreme loads
- in accordance with IEC 60670-1
- halogen free

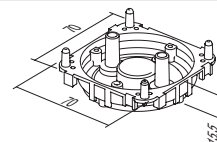

BE21

UVODNICA ZA KUTIJU ZA BETON 16

- za učvršćivanje instalacijske cijevi
- sukladno normi IEC 60670-1
- bez halogena

PIPE STOPPER CONCRETE BOX 16

- for firming installation pipe to box
- in accordance with IEC 60670-1
- halogen free

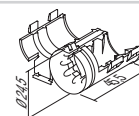

R O U N D

B O X E S

šuplji zidovi / hollow walls



beton / concrete



upute za ugradnju /
assembly instructions

razmak između kutija /
distance between boxes: 71mm

razmak između kutija /
distance between boxes: 91mm

HE10,11

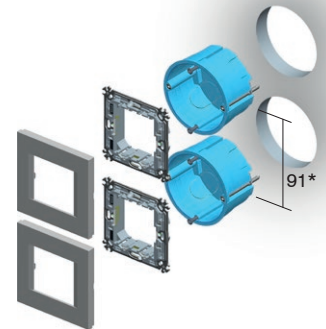
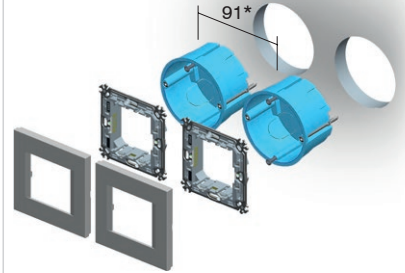
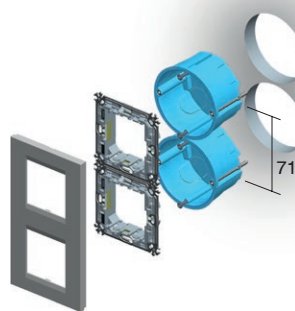
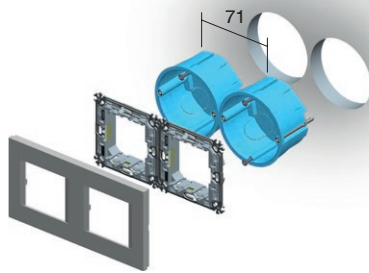
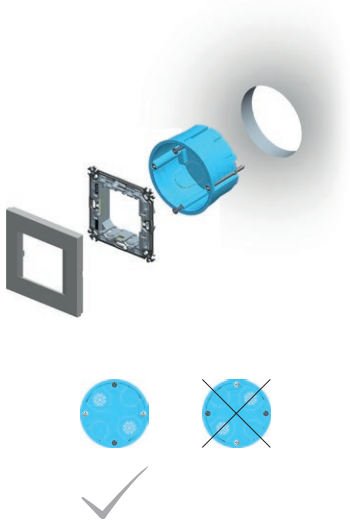

BE10

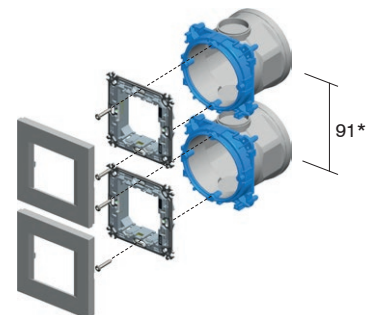
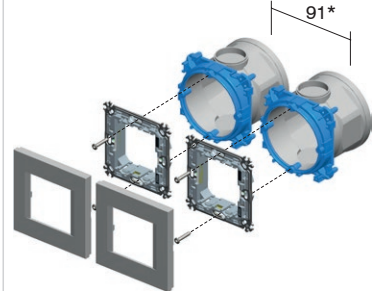
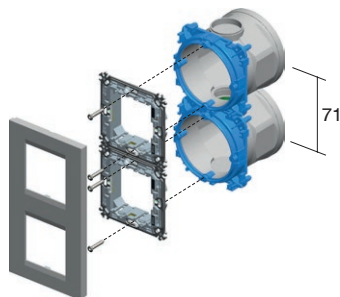
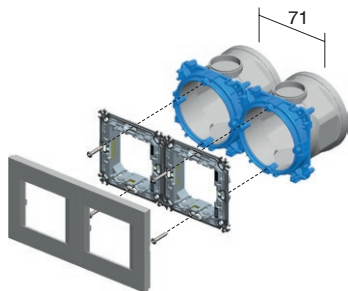
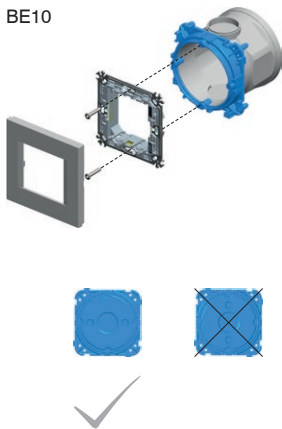

* za okvire PURE, min. razmak između kutija je 100 mm

* for PURE cover plates the minimum distance between boxes is 100mm

šuplji zidovi / hollow walls



beton / concrete

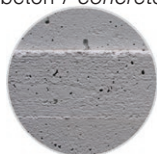

K U T I J E

HE10,11



BE10,11



NM21



NM25



2M

HE10,11



BE10,11



NM11



1/2M

2xHE10,11



2xBE10,11



2xNM21



2xNM25



2x2M

HE10,11



BE10,11



NM32



2/3M

2xHE10,11



2xBE10,11



2xNM21



2xNM25



3xHE10,11

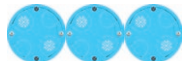

3xBE10,11



3xNM21



3xNM25



3x2M

3xHE10,11



3xBE10,11



3xNM21



3xNM25

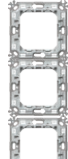

4xHE10,11



4xBE10,11



4xNM21



4xNM25



4x2M

4xHE10,11



4xBE10,11



4xNM21



4xNM25



R O U N D B O X E S

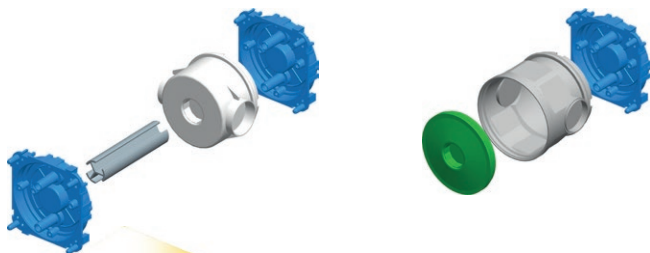

upute za ugradnju /
assembly instructions

1

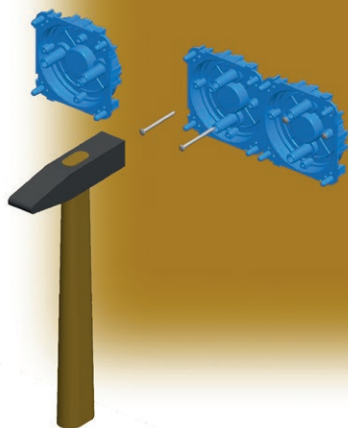

2

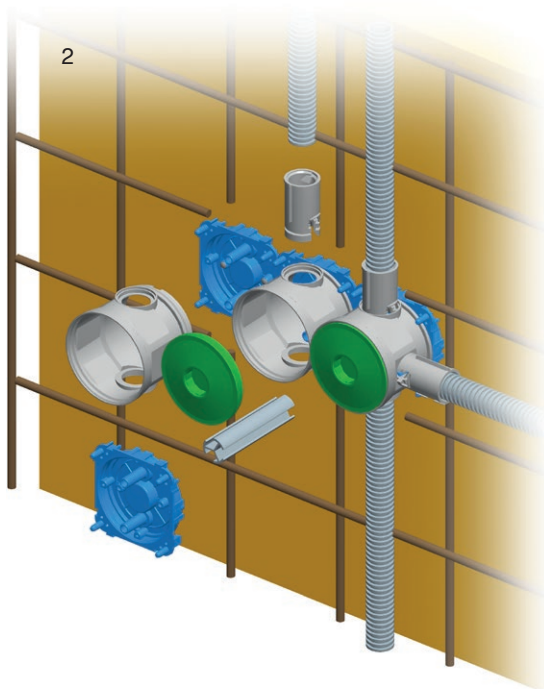

3

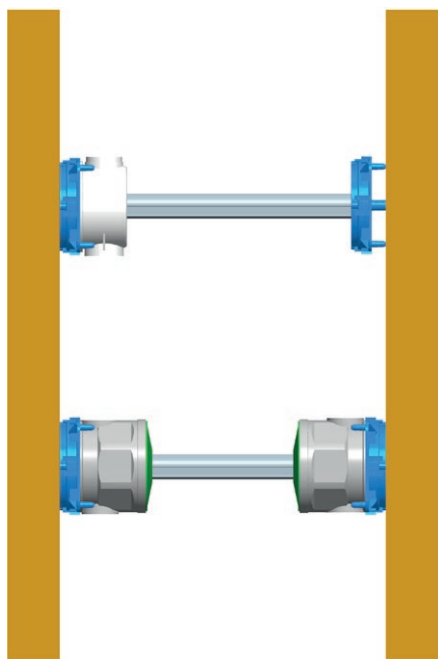

4

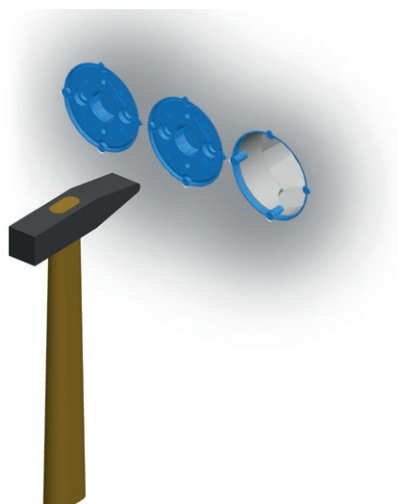

K U T I J E P R A V O K U T N E



DM30



HM30



BM30

K U T I J E

tip type	naziv description	veličina size
DM30	KUTIJA PRAVOKUTNA ZA ZID OD OPEKE PM3 <i>RECTANGULAR BOX BRICK</i>	
HM30	KUTIJA PRAVOKUTNA ZA ŠUPLJE ZIDOVE VM3 <i>RECTANGULAR BOX HOLLOW WALL</i>	
BM30	KUTIJA PRAVOKUTNA ZA BETON <i>RECTANGULAR BOX CONCRETE</i>	BM3
...

KUTIJA PRAVOKUTNA ZA ZID OD OPEKE PM3



DM30

- veličina 3M, dubina 49 mm
- 650°C, 400V ~
- sukladno normi IEC 60670-1
- bez halogena

RECTANGULAR BOX BRICK PM3

- size 3M, depth 49mm
- 650°C, 400V ~
- in accordance with IEC 60670-1
- halogen free

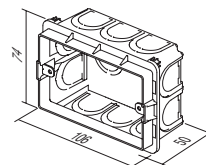

KUTIJA PRAVOKUTNA ZA ZID OD OPEKE PM3-65



DM31

- veličina 3M, dubina 65mm
- 650°C, 400V ~
- sukladno normi IEC 60670-1
- bez halogena

RECTANGULAR BOX BRICK PM3-65

- size 3M, depth 65mm
- 650°C, 400V ~
- in accordance with IEC 60670-1
- halogen free

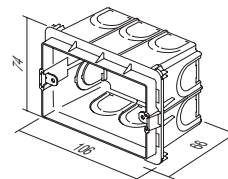

KUTIJA PRAVOKUTNA ZA ZID OD OPEKE PM4



DM40

- veličina 4M, dubina 49 mm
- 650°C, 400V ~
- sukladno normi IEC 60670-1
- bez halogena

RECTANGULAR BOX BRICK PM4

- size 4M, depth 49mm
- 650°C, 400V ~
- in accordance with IEC 60670-1
- halogen free

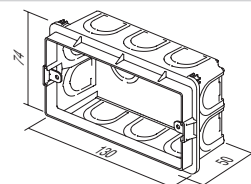

KUTIJA PRAVOKUTNA ZA ZID OD OPEKE PM4-65



DM41

- veličina 4M, dubina 65mm
- 650°C, 400V ~
- sukladno normi IEC 60670-1
- bez halogena

RECTANGULAR BOX BRICK PM4-65

- size 4M, depth 65mm
- 650°C, 400V ~
- in accordance with IEC 60670-1
- halogen free

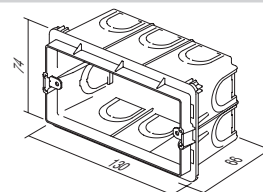

RECTANGULAR BOXES

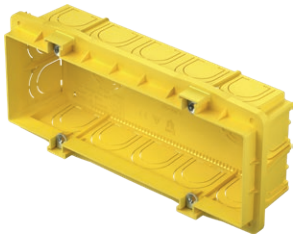

DM70

KUTIJA PRAVOKUTNA ZA ZID OD OPEKE PM7

- veličina 7M, dubina 49 mm
- 650°C, 400V ~
- sukladno normi IEC 60670-1
- bez halogena

RECTANGULAR BOX BRICK PM7

- size 7M, depth 49mm
- 650°C, 400V ~
- in accordance with IEC 60670-1
- halogen free

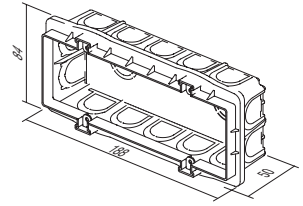

DM71

KUTIJA PRAVOKUTNA ZA ZID OD OPEKE PM7-65

- veličina 7M, dubina 65mm
- 650°C, 400V ~
- sukladno normi IEC 60670-1
- bez halogena

RECTANGULAR BOX BRICK PM7-65

- size 7M, depth 65mm
- 650°C, 400V ~
- in accordance with IEC 60670-1
- halogen free

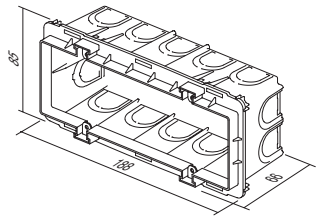

DM72

KUTIJA PRAVOKUTNA ZA ZID OD OPEKE PM72-65

- veličina 2x7M, dubina 64mm
- 650°C, 400V ~
- sukladno normi IEC 60670-1
- bez halogena

RECTANGULAR BOX BRICK PM72-65

- size 2x7M, depth 64mm
- 650°C, 400V ~
- in accordance with IEC 60670-1
- halogen free

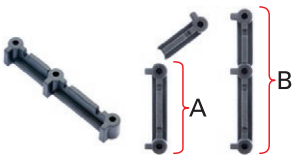
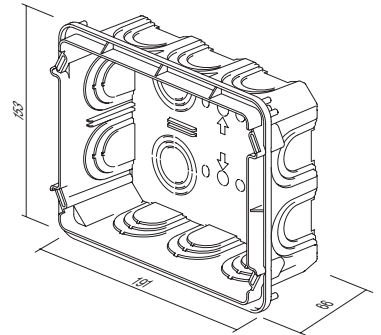

DM80

VEZNI ČLAN KUTIJE PM

- za okomito (A) i vodoravno (B) povezivanje kutija PM3, PM4 i PM7
- prikladan za dekorativne okvire Line i Soft (nije prikladan za PURE)

DISTANCE PIECE FOR BOX PM

- for vertical (A) and horizontal (B) fitting of boxes PM3, PM4 and PM7
- suitable for Line and Soft decorative cover plates (not for PURE)

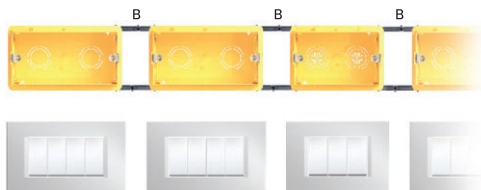
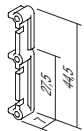



DM33

POKLOPAC KUTIJE ZAŠTITNI PM3

- zaštitni poklopac za kutiju PM3
- sukladno normi IEC 60670-1
- bez halogena
- zaštita kutije tijekom žbukanja

BOX COVER PROTECTIVE PM3

- protective cover for box PM3
- in accordance with IEC 60670-1
- halogen free
- box protection during plastering

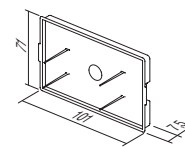

DM34

POKLOPAC KUTIJE DEKORATIVNI PM3

- dekorativni poklopac za kutije 3M
- vijci priloženi
- sukladno normi IEC 60670-1
- bez halogena

BOX COVER DECORATIVE PM3

- decorative cover for boxes 3M
- screws are included
- in accordance with IEC 60670-1
- halogen free

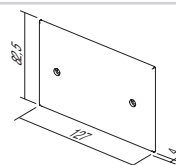

DM43

POKLOPAC KUTIJE ZAŠTITNI PM4

- zaštitni poklopac za kutiju PM4
- sukladno normi IEC 60670-1
- bez halogena
- zaštita kutije tijekom žbukanja

BOX COVER PROTECTIVE PM4

- protective cover for box PM4
- in accordance with IEC 60670-1
- halogen free
- box protection during plastering

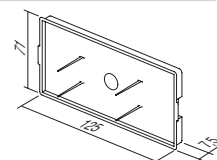

DM44

POKLOPAC KUTIJE DEKORATIVNI PM4

- dekorativni poklopac za kutije 4M
- vijci priloženi
- sukladno normi IEC 60670-1
- bez halogena

BOX COVER DECORATIVE PM4

- decorative cover for boxes 4M
- screws are included
- in accordance with IEC 60670-1
- halogen free

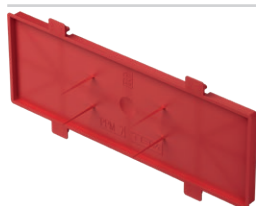
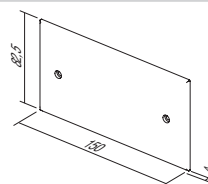

DM73

POKLOPAC KUTIJE ZAŠTITNI PM7

- zaštitni poklopac za kutiju PM7
- sukladno normi IEC 60670-1
- bez halogena
- zaštita kutije tijekom žbukanja

BOX COVER PROTECTIVE PM7

- protective cover for box PM7
- in accordance with IEC 60670-1
- halogen free
- box protection during plastering

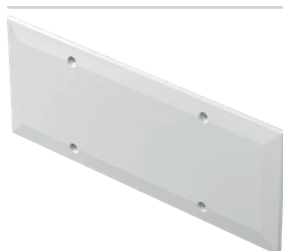
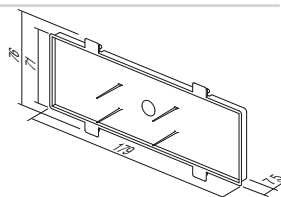

DM74

POKLOPAC KUTIJE DEKORATIVNI PM7

- dekorativni poklopac za kutije 7M
- vijci priloženi
- sukladno normi IEC 60670-1
- bez halogena

BOX COVER DECORATIVE PM7

- decorative cover for boxes 7M
- screws are included
- in accordance with IEC 60670-1
- halogen free

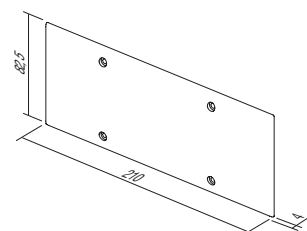

R E C T A N G U L A R B O X E S



DM75

POKLOPAC KUTIJE DEKORATIVNI PM72

- dekorativni poklopac za kutije 2x7M
- vijci priloženi
- sukladno normi IEC 60670-1

BOX COVER DECORATIVE PM72

- decorative cover for boxes 2x7M
- screws are included
- in accordance with IEC 60670-1

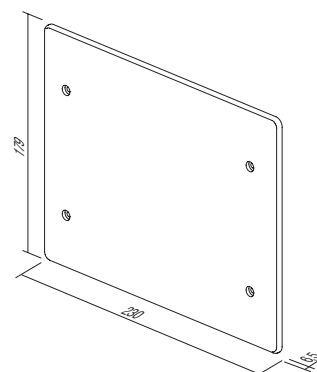



HM30

KUTIJA PRAVOKUTNA ZA ŠUPLJE ZIDOVE VM3

- veličina 3M, dubina 49 mm
- ugradni promjer 2xØ68/45mm
- 850°C, 400V
- sukladno normi IEC 60670-1
- bez halogena

RECTANGULAR BOX HOLLOW WALL VM3

- size 3M, depth 49mm
- cutting hole 2xØ68/45mm
- 850°C, 400V
- in accordance with IEC 60670-1
- halogen free

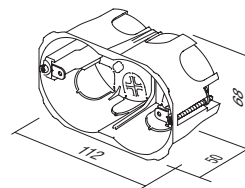

HM40

KUTIJA PRAVOKUTNA ZA ŠUPLJE ZIDOVE VM4

- veličina 4M, dubina 49 mm
- ugradni promjer 2xØ68/70mm
- 850°C, 400V
- sukladno normi IEC 60670-1
- bez halogena

RECTANGULAR BOX HOLLOW WALL VM4

- size 4M, depth 49mm
- cutting hole 2xØ68/70mm
- 850°C, 400V
- in accordance with IEC 60670-1
- halogen free

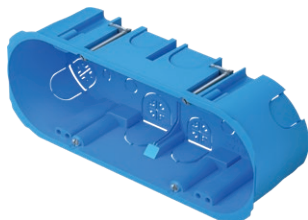
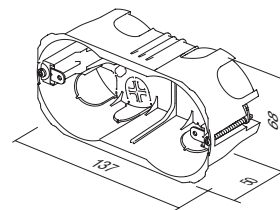

HM70

KUTIJA PRAVOKUTNA ZA ŠUPLJE ZIDOVE VM7

- veličina 7M, dubina 49 mm
- ugradni promjer 2xØ68/120mm
- 850°C, 400V
- sukladno normi IEC 60670-1
- bez halogena

RECTANGULAR BOX HOLLOW WALL VM7

- size 7M, depth 49mm
- cutting hole 2xØ68/120mm
- 850°C, 400V
- in accordance with IEC 60670-1
- halogen free

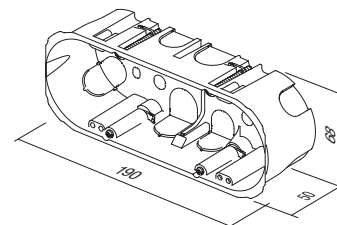

HM72

KUTIJA PRAVOKUTNA ZA ŠUPLJE ZIDOVE VM72







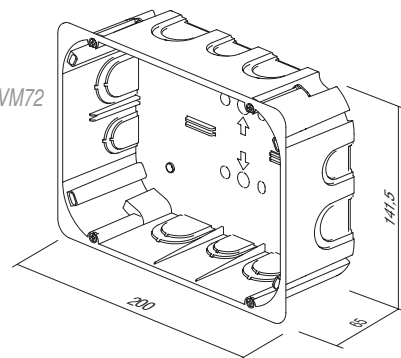

- veličina 2x7M, dubina 63mm
- 850°C, 400V
- sukladno normi IEC 60670-1
- bez halogena

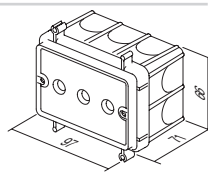
RECTANGULAR BOX HOLLOW WALL VM72

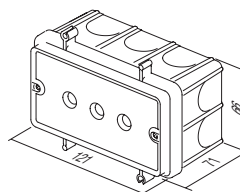
- size 2x7M, depth 63mm
- 850°C, 400V
- in accordance with IEC 60670-1
- halogen free

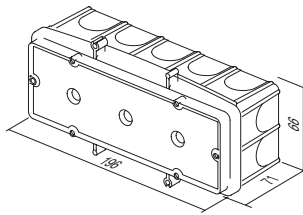

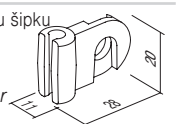
R E C T A N G U L A R B O X E S

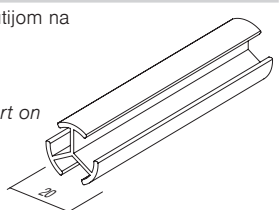
	BM30	PRAVOKUTNA KUTIJA ZA BETON BM3 - veličina 3M, dubina 60mm - 650°C, 400V ~ - sukladno normi IEC 60670-1 - bez halogena <i>RECTANGULAR BOX CONCRETE BM3</i> - size 3M, depth 60mm - 650°C, 400V ~ - in accordance with IEC 60670-1 - halogen free	
	BM40	PRAVOKUTNA KUTIJA ZA BETON BM4 - veličina 4M, dubina 60mm - 650°C, 400V ~ - sukladno normi IEC 60670-1 - bez halogena <i>RECTANGULAR BOX CONCRETE BM4</i> - size 4M, depth 60mm - 650°C, 400V ~ - in accordance with IEC 60670-1 - halogen free	
	BM70	PRAVOKUTNA KUTIJA ZA BETON BM7 - veličina 7M, dubina 60mm - 650°C, 400V ~ - sukladno normi IEC 60670-1 - bez halogena <i>RECTANGULAR BOX CONCRETE BM7</i> - size 7M, depth 60mm - 650°C, 400V ~ - in accordance with IEC 60670-1 - halogen free	
	BM80	PRIČVRSNI KOMBI-DRŽAČ BM - za brzo pričvršćivanje pravokutnih kutija BM na armiranu betonsku šipku - prikladno za šipku promjera do Ø8 mm <i>FIXING COMBI-CLIP BM</i> - for fast fixation of BM rectangular boxes on reinforcing bar - suitable for bar diameter up to Ø8mm	
	BM82	VEZNI PROFIL ZA KUTIJE BM - za podupiranje kutija BM s odgovarajućom kutijom na nasuprotnom zidu - duljina l = 1 m, promjer Ø20 mm <i>DISTANCE PROFIL FOR BOXES BM</i> - to support boxes BM with counter box support on opposite wall - length l=1m, diameter Ø20mm	

KUTIJE

K U T I J E P R A V O K U T N E



cigla / brick

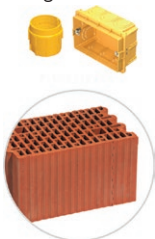

šuplji zidovi / hollow walls

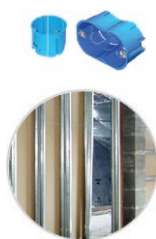

beton / concrete

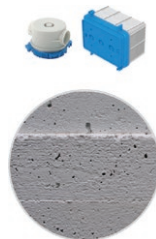



K U T I J E

DM30   **NM30**

HM30  

BM30 

3M



DM40   **NM40**

HM40  

BM40 

4M

DM70   **NM70**

HM70  

BM70 

7M

DM72   **NM72**

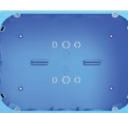
HM72 

2x7M

DM30   **NM32**

HM30  

BM30 

2/3M

RECTANGULAR BOXES

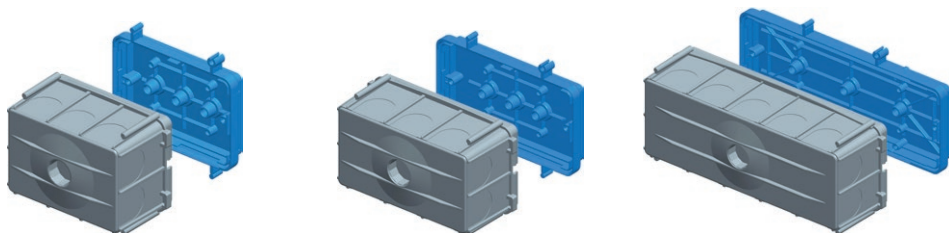

upute za ugradnju /
assembly instructions

1

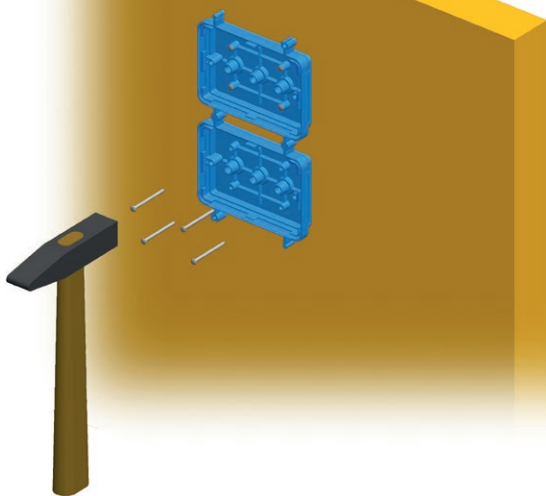

2

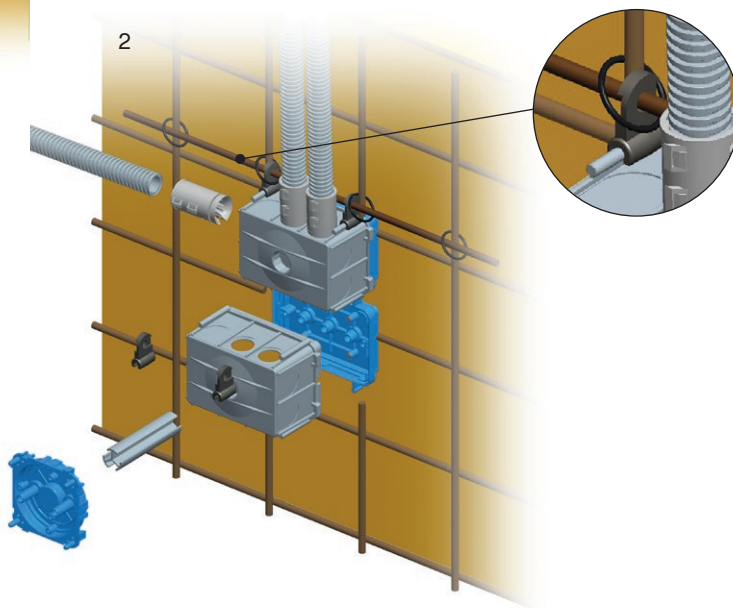

3

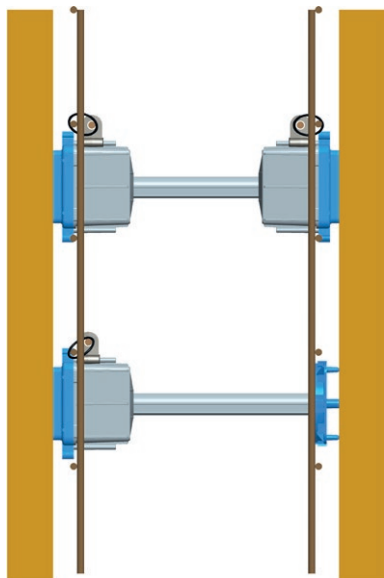

4

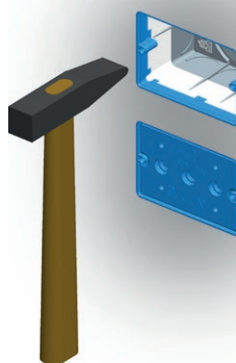



DW10

KUTIJA PRIKLJUČNA OKRUGLA ZA ZID OD OPEKE DSM78

- Ø78, dubina 40mm
- 650°C, 500V~
- sukladno normama IEC 60670-1 i IEC 60670-22
- bez halogena

CONNECTION ROUND BOX BRICK DSM78

- Ø78, depth 40mm
- 650°C, 500V~
- in accordance with IEC 60670-1 and IEC 60670-22
- halogen free

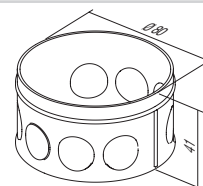

HW10

KUTIJA PRIKLJUČNA OKRUGLA ZA ŠUPLJE ZIDOVE SM78x45

- Ø78, dubina 45mm
- ugradni promjer Ø80
- 850°C, 400V~
- sukladno normama IEC 60670-1 i IEC 60670-22
- ugradnja s nožicama
- bez halogena

CONNECTION ROUND BOX HOLLOW WALL SM78x45

- Ø78, depth 45mm
- cutting hole Ø80
- 850°C, 400V~
- in accordance with IEC 60670-1 and IEC 60670-22
- mounting with claws
- halogen free

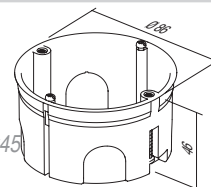

DE23

POKLOPAC KUTIJE DEKORATIVNI SM78

- dekorativni poklopac za kutije Ø78
- sukladno normama IEC 60670-1 i IEC 60670-22
- bez halogena

BOX COVER DECORATIVE SM78

- decorative cover for boxes Ø78
- in accordance with IEC 60670-1 and IEC 60670-22
- halogen free

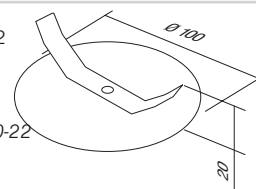

DE24

POKLOPAC KUTIJE ZAŠTITNI 78

- zaštitni poklopac za kutije Ø78
- sukladno normama IEC 60670-1 i IEC 60670-22
- bez halogena

BOX COVER PROTECTIVE 78

- protective cover for box Ø78
- in accordance with IEC 60670-1 and IEC 60670-22
- halogen free

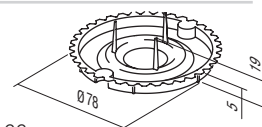

HW20

KUTIJA PRIKLJUČNA ČETVRTASTA ZA ZID OD OPEKE SM105x105

- veličina 105x105mm, dubina 50mm
- ugradnja u rupu prema priloženoj šablوني
- 850°C, 400V~
- sukladno normama IEC 60670-1 i IEC 60670-22
- ugradnja s nožicama
- bez halogena

CONNECTION SQUARE BOX BRICK SM105x105

- size 105x105mm, depth 50mm
- cutting hole according to attached template
- 850°C, 400V~
- in accordance with IEC 60670-1 and IEC 60670-22
- mounting with claws
- halogen free

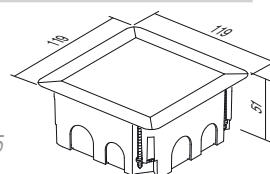

J U N C T I O N B O X E S

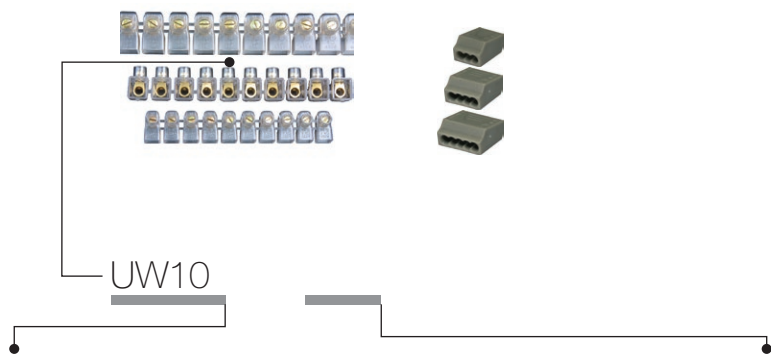

tip type	naziv description	tehnički podaci technical data	veličina size	boja colour
UW10	JEDNOREDNE STEZALJKE 1 ROW TERMINAL BLOCKS	2x2.5mm ²	10P	☑ TS transparentna transparent
UW11	JEDNOREDNE STEZALJKE 1 ROW TERMINAL BLOCKS	2x4mm ²	10P	☑ CO boja colour
UW12	JEDNOREDNE STEZALJKE 1 ROW TERMINAL BLOCKS	2x6mm ²	10P	☐ WH bijela white
⋮	⋮	⋮	⋮	☐ GY siva grey

JEDNOREDNE STEZALJKE ZATVORENE



- 450V[~]; 2x2,5mm² ÷ 2x6mm²
- termoplast PC, prozirne
- broj polova: 10

1 ROW TERMINAL BLOCKS CLOSED

- 450V[~]; 2x2.5mm² ÷ 2x6mm²
- termoplast PC, transparent
- number of poles: 10

UW10TS	(NS12)	2x2.5mm ²	10P
UW11TS	(NS12)	2x4mm ²	10P
UW12TS	(NS12)	2x6mm ²	10P

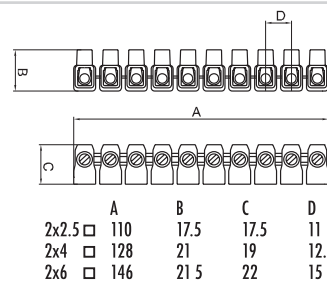

JEDNOREDNE STEZALJKE

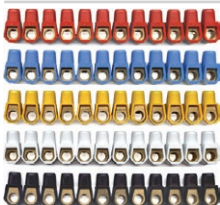

- 450V[~]; 2x2,5mm² ÷ 2x6mm²
- termoplast PA
- dostupne u raznim bojama
- broj polova: 12

1 ROW TERMINAL BLOCKS

- 450V[~]; 2x2.5mm² ÷ 2x6mm²
- termoplast PA
- available in different colours
- number of poles: 12

UW15CO	(NS12)	2x2.5mm ²	12P
UW16CO	(NS12)	2x4mm ²	12P
UW17CO	(NS12)	2x6mm ²	12P

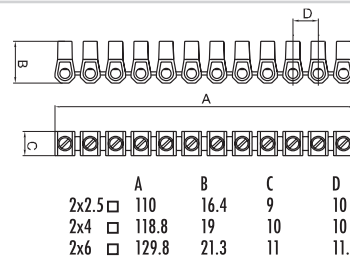

DVOREDNE STEZALJKE PP

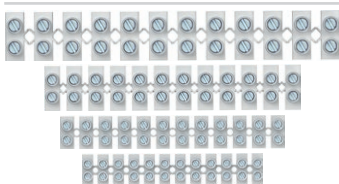

- 450 V[~]; 1 mm² ÷ 16 mm²
- termoplast polipropilen PP, bijele
- za upotrebu do 80 °C
- broj polova: 12

2 ROW TERMINAL BLOCKS PP

- 450V[~]; 1mm² ÷ 16mm²
- termoplast polypropylene PP, white
- for temperatures up to 80°C
- number of poles: 12

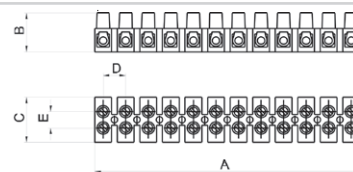

					A	B	C	D	E
UW29WHPP	1.0-4.0mm ²	24 A	450 V		94,9	13	16,6	8,1	6,4
UW30WHPP	1.5-6.0mm ²	32 A	450 V		116,5	14,9	18,9	10	7,3
UW31WHPP	2.5-10mm ²	41 A	450 V		133,8	17,3	23,4	11,5	10
UW32WHPP	4-16mm ²	76 A	450 V		174,5	20,7	25	15	11

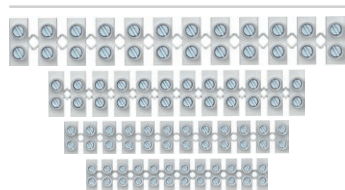

DVOREDNE STEZALJKE PA

- 450 V \sim ; 1 mm² ÷ 16 mm²
- termoplast poliamid PA, bijele
- za upotrebu do 110 °C
- broj polova: 12

2 ROW TERMINAL BLOCKS PA

- 450V \sim ; 1mm² ÷ 16mm²
- thermoplast polyamide PA, white
- for temperatures up to 110°C
- number of poles: 12

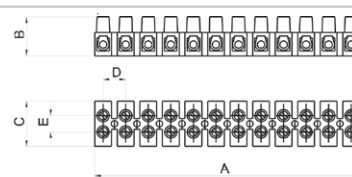

					A	B	C	D	E
UW25WHPA	1.0-4.0mm ²	24 A	450 V		93,6	13,4	16,2	8	6,4
UW26WHPA	1.5-6.0mm ²	32 A	450 V		117	15	18,6	10	7,3
UW27WHPA	2.5-10mm ²	41 A	450 V		132,8	17,3	22,2	11,5	10
UW28WHPA	4-16mm ²	76 A	450 V		173,9	20,8	25,2	15	11



BEZVIJČANE REDNE STEZALJKE

- 24A 450V \sim , termoplast PA, sive
- broj polova: 3÷8
- bezvijčani kontakti 0,5 ÷ 1,5 mm², za tvrde žice
- sukladno normi EN 60998-1

PLUG-IN WIRE CONNECTORS

- 24A 450V \sim , thermoplast PA, grey
- number of poles: 3÷8
- plug-in contacts 0.5÷1.5mm², for rigide wires
- in accordance with EN 60998-1



UW40GY	PC153	1.5mm ²	3P	3P	A	B	C
UW41GY	PC155	1.5mm ²	5P	5P	12	18	9
UW42GY	PC158	1.5mm ²	8P	8P	17	18	9
					26	18	9



BEZVIJČANE REDNE STEZALJKE

- 24A 450V \sim , termoplast PA, sive
- broj polova: 3÷5
- bezvijčani kontakti 1,5 ÷ 2,5 mm², za tvrde žice
- sukladno normi EN 60998-1

PLUG-IN WIRE CONNECTORS

- 24A 450V \sim , thermoplast PA, grey
- number of poles: 3÷5
- plug-in contacts 1.5÷2.5mm², for rigide wires
- in accordance with EN 60998-1



UW45GY	PC253	2.5mm ²	3P	3P	A	B	C
UW46GY	PC254	2.5mm ²	4P	4P	14	19	9
UW47GY	PC255	2.5mm ²	5P	5P	17	19	9
					21	19	9



BEZVIJČANE REDNE STEZALJKE

- 24A 450V \sim , termoplast PA, sive
- broj polova: 2 (tvrda žica) + 1 (meka žica)
- bezvijčani kontakti 1,5 ÷ 2,5mm²
- sukladno normi EN 60998-1

PLUG-IN WIRE CONNECTOR

- 24A 450V \sim , thermoplast PA, grey
- number of poles: 2 (rigide wire)+1 (soft wire)
- plug-in contacts 1.5÷2.5mm²
- in accordance with EN 60998-1

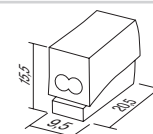



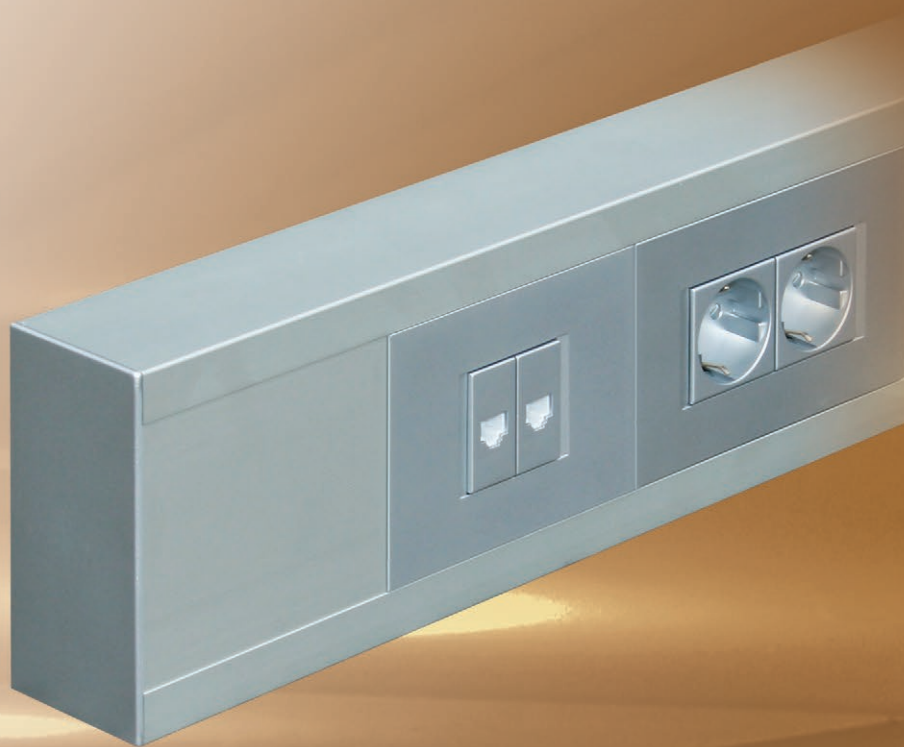

UW50WH	PC302	2.5mm ²	2/1P				
--------	-------	--------------------	------	--	--	--	--

TEM





<hr/> <i>KUĆIŠTA CUBO IP20 AC</i> <i>BOXES CUBO IP20 AC</i>		162
<hr/> <i>KUĆIŠTA CUBO IP55 AQ</i> <i>BOXES CUBO IP55 AQ</i>		163
<hr/> <i>PARAPETNI KANALI ALUMINIJ MA</i> <i>TRUNKING SYSTEM ALUMINIUM MA</i>		165
<hr/> <i>PODNE KUTIJE MT</i> <i>FLOOR BOXES MT</i>		171
<hr/> <i>RAZDJELNICI MO</i> <i>DISTRIBUTION BOARDS MO</i>		173

K U Ć I Š T A

C U B O

I P 5 5

A Q

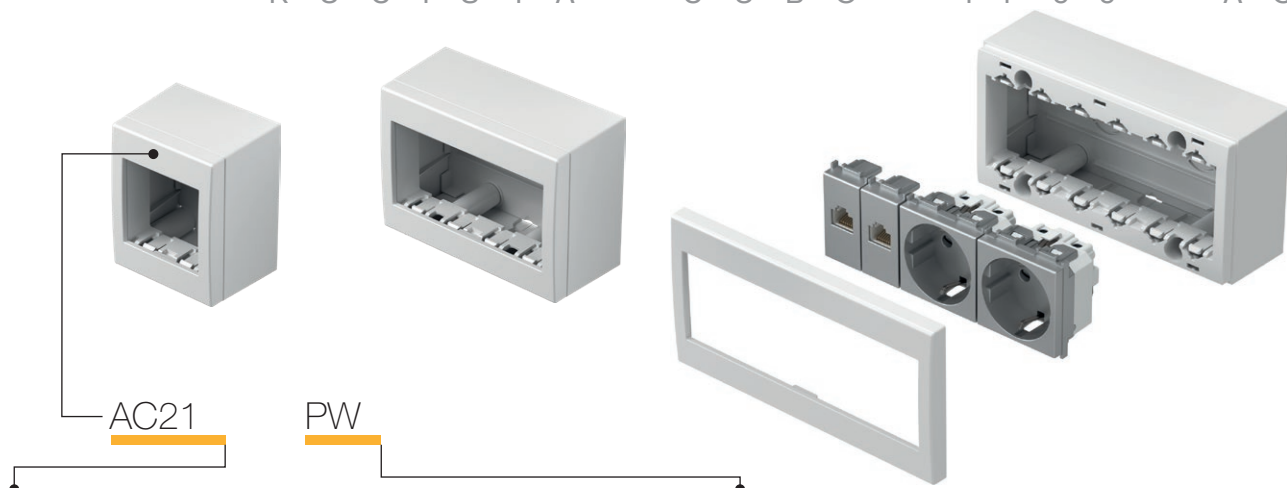

tip type	naziv description	tehnički podaci technical data	veličina size	boja colour
AC11	NADŽBUKNA KUTIJA SA STRAŽNJIM POKLOPCEM SURFACE MOUNT BOX WITH BACK SIDE COVER	IP20	1M	<input type="checkbox"/> PW bijela sjajna polar white
AC21	NADŽBUKNA KUTIJA SA STRAŽNJIM POKLOPCEM SURFACE MOUNT BOX WITH BACK SIDE COVER	IP20	2M	<input type="checkbox"/> ES srebrna mat elox silver
		IP20	4M	<input type="checkbox"/> IW bež sjajna ivory white
AC41	NADŽBUKNA KUTIJA SA STRAŽNJIM POKLOPCEM SURFACE MOUNT BOX WITH BACK SIDE COVER			

KUTIJA NO CUBO SA STRAŽNJIM POKLOPCEM IP20 1M



- AC11PW
- AC11ES
- AC11IW

- kutija IP20 1M
- za nadžbukno pričvršćivanje elemenata
- prikladno za SM sklopke
- sukladno normi EN 60669-1

BOX NO CUBO WITH BACK SIDE COVER IP20 1M

- box IP20 1M
- for surface mounting of elements
- suitable to SM switches
- in accordance with EN 60669-1



KUTIJA NO CUBO SA STRAŽNJIM POKLOPCEM IP20 2M



- AC21PW
- AC21ES
- AC21IW

- kutija IP20 2M
- za nadžbukno pričvršćivanje elemenata
- sukladno normama EN 60669-1, EN60884-1

BOX NO CUBO WITH BACK SIDE COVER IP20 2M

- box IP20 2M
- for surface mounting of elements
- in accordance with EN 60669-1, EN60884-1



KUTIJA NO CUBO SA STRAŽNJIM POKLOPCEM IP20 4M



- AC41PW
- AC41ES
- AC41IW

- kutija IP20 4M
- za nadžbukno pričvršćivanje elemenata
- sukladno normama EN 60669-1, EN60884-1

BOX NO CUBO WITH BACK SIDE COVER IP20 4M

- box IP20 4M
- for surface mounting of elements
- in accordance with EN 60669-1, EN60884-1



KUTIJA NO CUBO SA STRAŽNJIM POKLOPCEM IP20 6M



- AC61PW
- AC61ES
- AC61IW

- kutija IP20 6M
- za nadžbukno pričvršćivanje elemenata
- sukladno normama EN 60669-1, EN60884-1

BOX NO CUBO WITH BACK SIDE COVER IP20 6M

- box IP20 6M
- for surface mounting of elements
- in accordance with EN 60669-1, EN60884-1

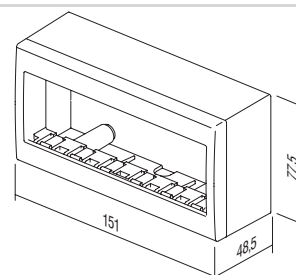
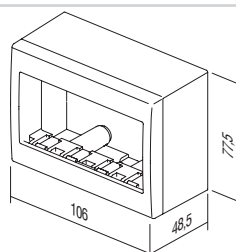
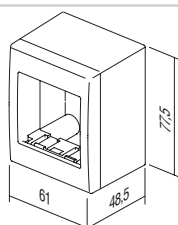
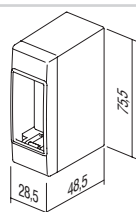

B O X E S C U B O I P 5 5 A Q

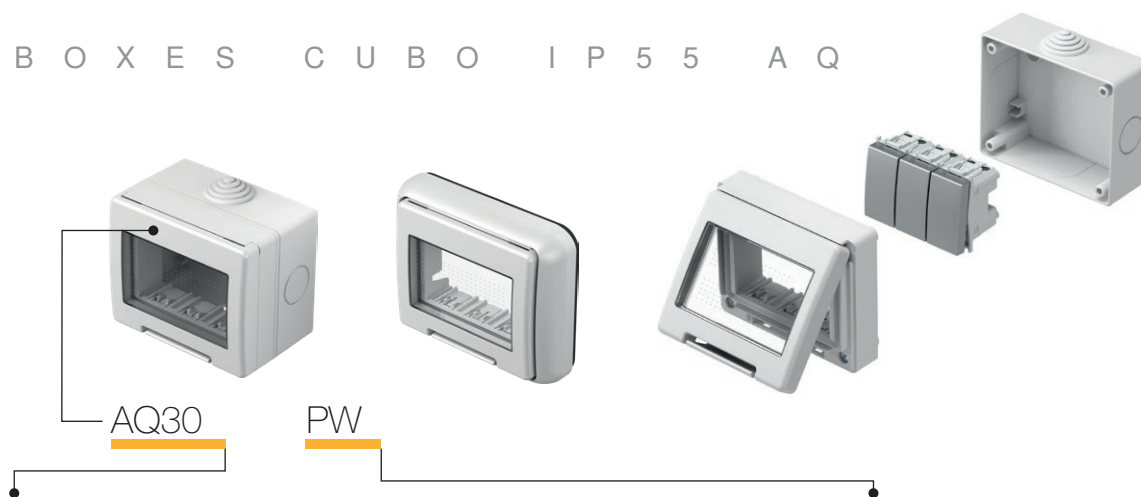

AQ30

PW

tip type	naziv description	tehnički podaci technical data	veličina size	boja colour
AQ20	VANJSKA NADŽBUKNA KUTIJA OUTDOOR SURFACE MOUNT BOX	IP55	2M	<input type="checkbox"/> PW bijela sjajna polar white
AQ22	VANJSKA NADŽBUKNA KUTIJA OUTDOOR SURFACE MOUNT BOX	IP55	2x2M	<input checked="" type="checkbox"/> GY siva grey
AQ30	VANJSKA NADŽBUKNA KUTIJA OUTDOOR SURFACE MOUNT BOX	IP55	3M	
AQ31	VANJSKA NADŽBUKNA KUTIJA OUTDOOR SURFACE MOUNT BOX	IP55	3M	

KUTIJA NO CUBO IP55 2M



- AQ20PW
 AQ20GY

- kutija IP55 2M
- za nadžbukno pričvršćivanje
- IP55 za ugradnju u vlažnom prostoru
- sukladno normama CEI 23-48, EN 60670

BOX NO CUBO IP55 2M

- box IP55 2M
- for surface mounting
- IP55 for usage in humid areas
- in accordance with CEI 23-48, EN 60670



KUTIJA NO CUBO IP55 2x2M



- AQ22PW
 AQ22GY

- kutija IP55 2x2M
- za nadžbukno pričvršćivanje
- IP55 za ugradnju u vlažnom prostoru
- sukladno normama CEI 23-48, EN 60670

BOX NO CUBO IP55 2x2M

- box IP55 2x2M
- for surface mounting
- IP55 for usage in humid areas
- in accordance with CEI 23-48, EN 60670



KUTIJA NO CUBO IP55 3M



- AQ30PW
 AQ30GY

- kutija IP55 3M
- za nadžbukno pričvršćivanje
- IP55 za ugradnju u vlažnom prostoru
- sukladno normama CEI 23-48, EN 60670

BOX NO CUBO IP55 3M

- box IP55 3M
- for surface mounting
- IP55 for usage in humid areas
- in accordance with CEI 23-48, EN 60670



KUTIJA PO CUBO IP55 3M



- AQ31PW
 AQ31GY

- kutija IP55 3M
- za podžbukno pričvršćivanje
- IP55 za ugradnju u vlažnom prostoru
- sukladno normama CEI 23-48, EN 60670

BOX PO CUBO IP55 3M

- box IP55 3M
- for flush mounting
- IP55 for usage in humid areas
- in accordance with CEI 23-48, EN 60670





□ AQ21PW

KUTIJA PO CUBO IP55 2M

- kutija IP55 2M
- moguće kombinacije sa svim funkcijskim elementima Modul
- za podžbukno pričvršćivanje
- IP55 za ugradnju u vlažnom prostoru
- sukladno normama CEI 23-48, EN 60670

BOX PO CUBO IP55 2M

- box IP55 2M
- can be combined with all Modul functional elements
- for flush mounting
- IP55 for usage in humid areas
- in accordance with CEI 23-48, EN 60670

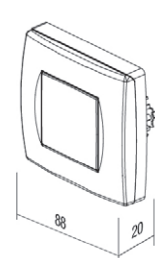
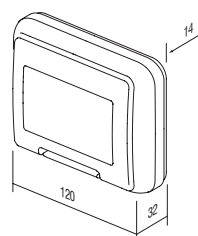
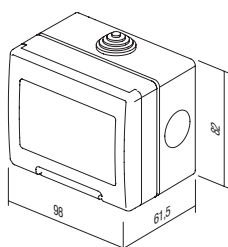
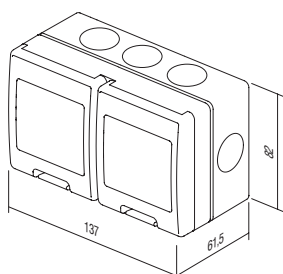
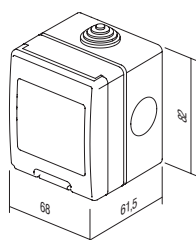

TRUNKING SYSTEM ALUMINIUM

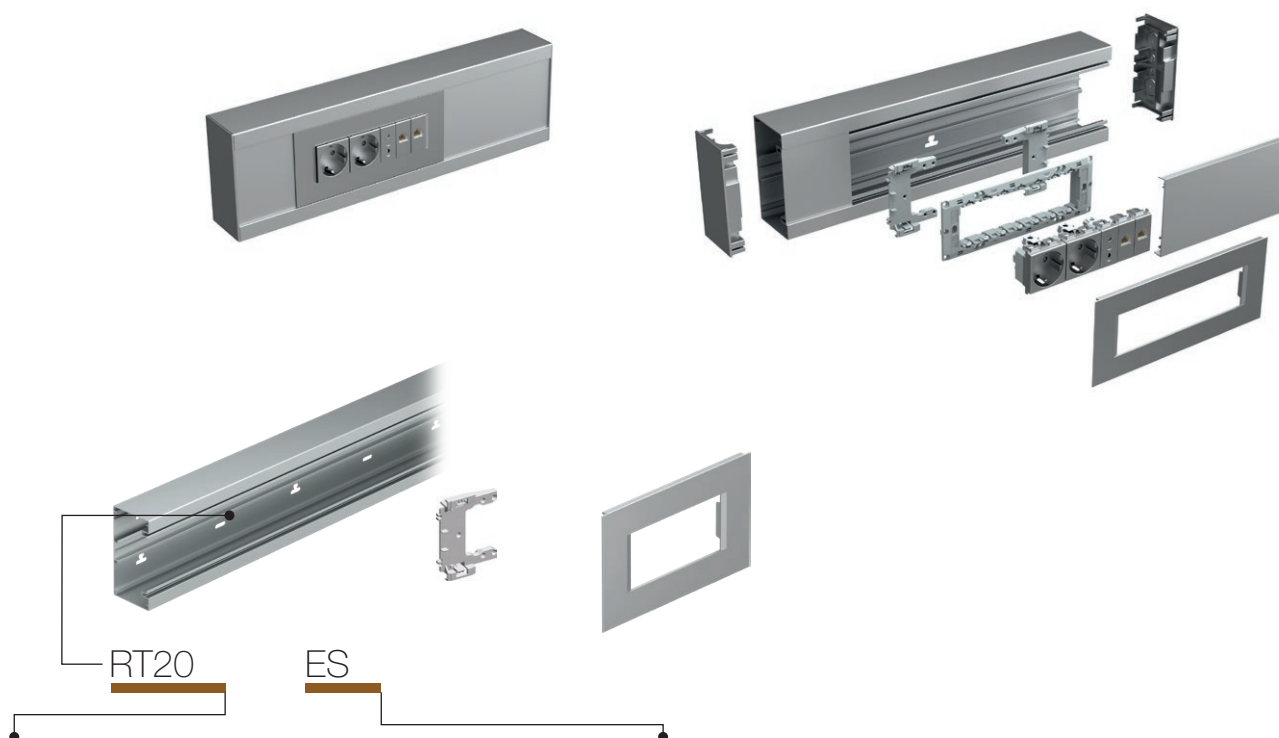

tip type	naziv description	veličina size	boja colour
RT10	ADAPTER MA 92 ADAPTER MA 92	/	■ ES srebrna mat elox silver-mat
RT12	POKLOPAC MA 92 COVER PLATE MA 92	2/3M	□ PW bijela mat (RAL 9016) white-mat
RT14	POKLOPAC MA 92 COVER PLATE MA 92	4M	
⋮	⋮	⋮	

ADAPTER MA 92



RT10

- adapter za pričvršćivanje nosača 2/3M, 4M ili 7M na kanal MA bez kutije
- za svaki su nosač potrebna dva adaptera
- sukladno normi EN 50085-1

ADAPTER MA 92

- adapter for fixing mounting frames 2/3M, 4M or 7M on MA trunking without box
- each mounting frame needs two adapters
- in accordance with EN 50085-1

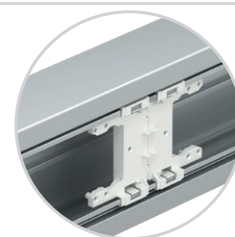

POKLOPAC MA 92 2/3M



■ RT12ES
□ RT12PW

- dekorativni poklopac MA 2/3M
- sukladno normi EN 50085-1

COVER PLATE MA 92 2/3M

- decorative cover plate MA 2/3M
- in accordance with EN 50085-1

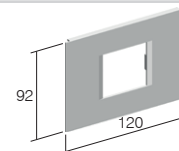

POKLOPAC MA 92 4M



■ RT14ES
□ RT14PW

- dekorativni poklopac MA 4M
- sukladno normi EN 50085-1

COVER PLATE MA 92 4M

- decorative cover plate MA 4M
- in accordance with EN 50085-1

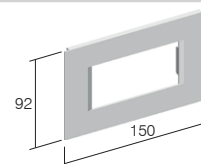

POKLOPAC MA 92 7M



■ RT17ES
□ RT17PW

- dekorativni poklopac MA 7M
- sukladno normi EN 50085-1

COVER PLATE MA 92 7M

- decorative cover plate MA 7M
- in accordance with EN 50085-1

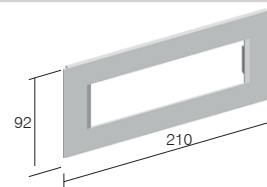



- RT20ES
- RT20PW

OSNOVA KANALA MA 130x65

- osnova kanala od ekstrudiranog aluminija
- visina 130 mm, duljina 2 m
- DIN tračnica 35 mm na dnu
- sukladno normi EN 50085-1

TRUNKING BASE MA 130x65

- trunking base from extruded aluminium
- height 130mm, length 2m
- DIN - rail 35mm shape on bottom
- in accordance with EN 50085-1

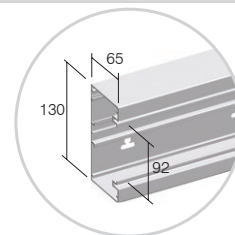

- RT21ES
- RT21PW

OSNOVA KANALA MA 165x65

- osnova kanala od ekstrudiranog aluminija
- visina 165mm, duljina 2 m
- DIN tračnica 35 mm na dnu
- sukladno normi EN 50085-1

TRUNKING BASE MA 165x65

- trunking base from extruded aluminium
- height 165mm, length 2m
- DIN - rail 35mm shape on bottom
- in accordance with EN 50085-1

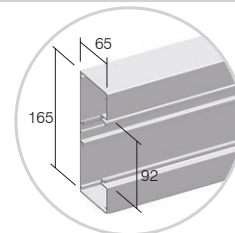

- RT25ES
- RT25PW

POKLOPAC KANALA MA 92

- poklopac kanala od ekstrudiranog aluminija
- visina 92mm, duljina 2 m
- sukladno normi EN 50085-1

FRONT COVER MA 92

- front cover from extruded aluminium
- height 92mm, length 2m
- in accordance with EN 50085-1

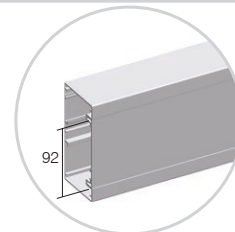

RT30

PREGRADA MA 43

- pregrada od ekstrudiranog polimera
- dubina 43 mm, duljina 2 m
- sukladno normi EN 50085-1

CABLE SHELF MA 43

- cable shelf from extruded polymer
- depth 43mm, length 2m
- in accordance with EN 50085-1

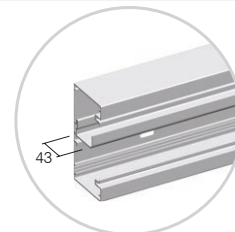

RT31

PREGRADA MA 43 AL

- pregrada od ekstrudiranog aluminija
- dubina 43 mm, duljina 2 m
- sukladno normi EN 50085-1

CABLE SHELF MA 43 AL

- cable shelf from extruded aluminium
- depth 43mm, length 2m
- in accordance with EN 50085-1

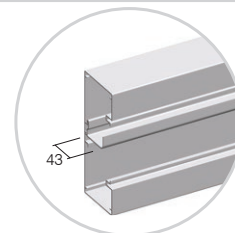

RT32

PREGRADA MA 43 AL DVOSTRUKA

- dvostruka pregrada od ekstrudiranog aluminija
- dubina 43 mm, duljina 2 m
- sukladno normi EN 50085-1

CABLE SHELF MA 43 AL DOUBLE

- double cable shelf from extruded aluminium
- depth 43mm, length 2m
- in accordance with EN 50085-1

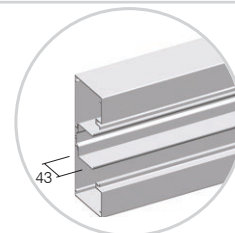

	<input checked="" type="checkbox"/> RT35ES <input type="checkbox"/> RT35PW	ZAVRŠNI ELEMENT MA 130x65 - završni element od polimera - visina 130mm - sukladno normi EN 50085-1 <i>STOP END MA 130x65</i> - stop end element from polymer - height 130mm - in accordance with EN 50085-1	
	<input checked="" type="checkbox"/> RT36ES <input type="checkbox"/> RT36PW	ZAVRŠNI ELEMENT MA 165x65 - završni element od metala - visina 165mm - sukladno normi EN 50085-1 <i>STOP END MA 165x65</i> - stop end element from metal - height 165mm - in accordance with EN 50085-1	
	RT38	SET SPOJNI ELEMENT MA 65 - spojni element od polimera - set sadrži 2 spojna elementa i vijke - sukladno normi EN 50085-1 <i>SET JOINING PIECE MA 65</i> - joining piece from polymer - set contains two pieces and screws - in accordance with EN 50085-1	
	<input checked="" type="checkbox"/> RT40ES <input type="checkbox"/> RT40PW	UNIVERZALNI KUT MA 130x65 - univerzalni kutni element - visina 130mm - sukladno normi EN 50085-1 <i>UNIVERSAL CORNER MA 130x65</i> - universal corner element - height 130mm - in accordance with EN 50085-1	
	<input checked="" type="checkbox"/> RT41ES <input type="checkbox"/> RT41PW	UNIVERZALNI KUT MA 165x65 - univerzalni kutni element - visina 165mm - sukladno normi EN 50085-1 <i>UNIVERSAL CORNER MA 165x65</i> - universal corner element - height 165mm - in accordance with EN 50085-1	
	RT42	ELEMENT ZA UZEMLJENJE MA 2x A6.3 - element za uzemljenje osnove kanala i poklopca - sukladno normi EN 50085-1 <i>EARTHING PIECE MA 2x A6.3</i> - earthing piece for earthing of trunking base and front cover - in accordance with EN 50085-1	

L-KOMAD ELEMENT MA 130x65

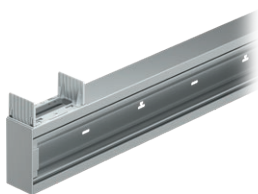

- RT43ES
- RT43PW

- univerzalni L-komad od aluminija
- visina 130 mm, duljina 400mm
- sukladno normi EN 50085-1

L-BEND MA 130x65

- universal L bend element from aluminium
- height 130mm, length 400mm
- in accordance with EN 50085-1

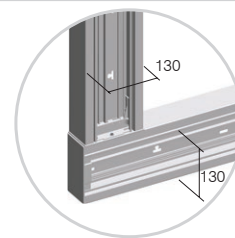

L-KOMAD ELEMENT MA 165x65



- RT44ES
- RT44PW

- univerzalni L-komad od aluminija
- visina 165mm, duljina 400mm
- za povezivanje na MA 130x65
- sukladno normi EN 50085-1

L-BEND MA 165x65

- universal L bend element from aluminium
- height 165mm, length 400mm
- connection on MA 130x65
- in accordance with EN 50085-1

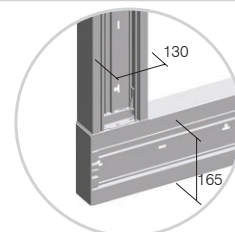

T-KOMAD MA 130x65



- RT45ES
- RT45PW

- univerzalni T-komad od aluminija
- visina 130 mm, duljina 400mm
- sukladno normi EN 50085-1

T-BEND MA 130x65

- universal T bend element from aluminium
- height 130mm, length 400mm
- in accordance with EN 50085-1

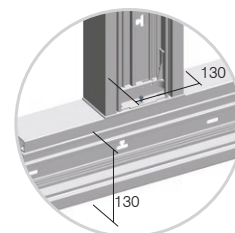

T-KOMAD MA 165x65



- RT46ES
- RT46PW

- univerzalni T-komad od aluminija
- visina 165mm, duljina 400mm
- za povezivanje na MA 130x65
- sukladno normi EN 50085-1

T-BEND MA 165x65

- universal T bend element from aluminium
- height 165mm, length 400mm
- connection on MA 130x65
- in accordance with EN 50085-1

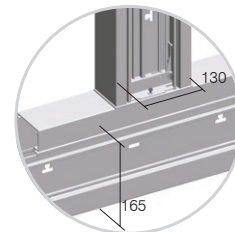

MA parapetni kanali temelje se na modularnom sustavu s kombinacijama elemenata veličine 2M, 4M ili 7M
MA trunking is based on modular system making 2M, 4M or 7M combinations of elements

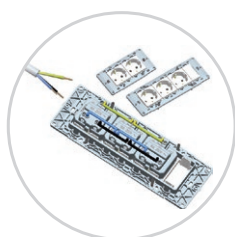

Modul sadrži specijalne elemente pripremljene za brzu instalaciju
In Modul we provide special elements for quick installation

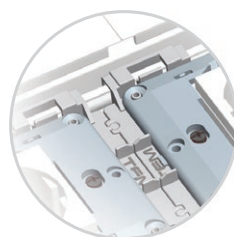

Adapter MA omogućuje točno postavljanje bez dodatnog napora
With Adapter MA exact positioning without extra effort is provided

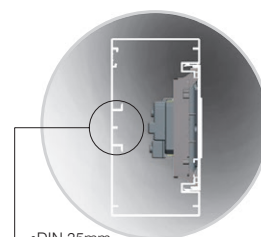

Montaža bez kutije znači više prostora za kablove, DIN tračnica ima oblik sukladan normi EN 60715
Mounted without box means more space for cables, DIN-rail base shape EN-60715

T R U N K I N G S Y S T E M A L U M I N I U M

**NOSAČ STUPIČA MA JEDNOSTRUKI 130x65**

- RT50ES
- RT50PW

- nosač za pričvršćivanje kanala MA130 na podu i/ili na stropu
- sukladno normi EN 50085-1

FIXING PLATE MA SINGLE 130x65

- fixing plate for fixing trunking base MA130 on the floor
and/or on the ceiling
- in accordance with EN 50085-1



- RT51ES
- RT51PW

NOSAČ STUPIČA MA DVOSTRUKI 130x65

- nosač za pričvršćivanje dva kanala MA130 na podu
i/ili na stropu
- sukladno normi EN 50085-1

FIXING PLATE MA DOUBLE 130x65

- fixing plate for fixing two trunking bases MA130 on the
floor and/or on the ceiling
- in accordance with EN 50085-1



- RT52ES
- RT52PW

STUPIČ MA 130x65x500

- stupač MA
- visina 500mm
- nosač 7M ugrađen
- sukladno normi EN 50085-1

SERVICE POST MA 130x65x500

- service post MA
- height 500mm
- mounting frame 7M included
- in accordance with EN 50085-1



- RT53ES
- RT53PW

STUPIČ MA DVOSTRUKI 130x130x500

- stupač MA dvostruki
- visina 500mm
- nosači 7M ugrađeni
- sukladno normi EN 50085-1

SERVICE POST MA DOUBLE 130x130x500

- service post MA double
- height 500mm
- mounting frames 7M included
- in accordance with EN 50085-1

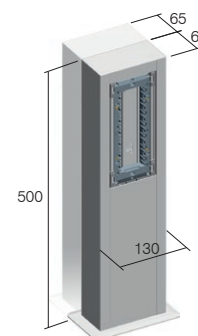

Cable intersection mm ²	Poprečni presjek vodiča / Cable cross-section (mm ²)				
	1 vodič / 1 wire	2 vodiča / 2 wires	3 vodiča / 3 wires	4 vodiča / 4 wires	5 vodiča / 5 wires
1,5	44	111	121	144	169
2,5	49	133	157	169	211
4	58	169	183	211	256
6	68	196	225	256	307

Kapacitet parapetnog kanala / Trunk capacity				
Kanal / Trunk	MA 130x65 prazan / empty	MA 130x65 s Modul sklopkama i utičnicama / with Modul switches and sockets	MA 165x65 prazan / empty	MA 130x65 s Modul sklopkama i utičnicama / with Modul switches and sockets
kapaciteta capacity	7600 mm ²	5500 mm ²	9900 mm ²	7800 mm ²
max ø	54 mm	2x42 mm	54 mm	2x42 mm



RB33

distribucija

tip type	naziv description	tehnički podaci technical data
RB30	PODNA KUTIJA FLOOR BOX	MT 7
RB31	SPOJNA PRIRUBNICA PODNE KUTIJE MT 7 FLOOR BOX FLANGE	
RB33	PODNA KUTIJA FLOOR BOX	MT 14
⋮	⋮	⋮

	RB30	RB33	RB36	RB40	RB43	RB46
a	170	260	350	170	260	350
b	260	260	260	260	260	260
X	140	230	320	140	230	320
Y	230	230	230	230	230	230

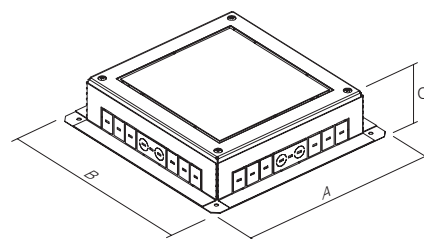
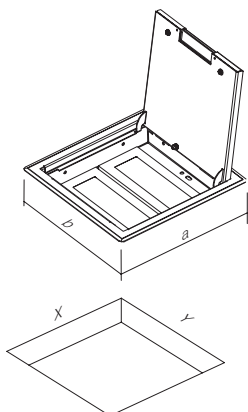

	RB31	RB34	RB37	RB41	RB44	RB47
A	250	340	430	250	340	430
B	340	340	340	340	340	340
C	95-125	95-125	95-125	125-150	125-150	125-150

PODNA KUTIJA MT 7

RB30

- podna kutija MT 7
- metalna, srebrne boje RAL 9006
- nosač MODUL 7M ugrađen
- ugradne dimenzije 140x230 mm, dubina min. 95 mm
- debljina podne obloge poklopca do 10 mm
- sukladno normama EN 50085-1 i EN 50085-2-2

FLOOR BOX MT 7

- floor box MT 7
- metal, colour silver RAL 9006
- mounting frame MODUL 7M included
- mounting dimensions 140x230mm, depth min 95mm
- floor lining thickness up to 10mm
- in accordance with EN 50085-1 and EN 50085-2-2

PODNA KUTIJA MT 7 H = 88mm

RB40

- podna kutija MT 7
- metalna, srebrne boje RAL 9006
- nosač MODUL 7M ugrađen
- ugradne dimenzije 140x230 mm, dubina min. 120mm
- debljina podne obloge poklopca do 10 mm
- sukladno normama EN 50085-1 i EN 50085-2-2

FLOOR BOX MT 7 H=88mm

- floor box MT 7
- metal, colour silver RAL 9006
- mounting frame MODUL 7M included
- mounting dimensions 140x230mm, depth min 120mm
- floor lining thickness up to 10mm
- in accordance with EN 50085-1 and EN 50085-2-2

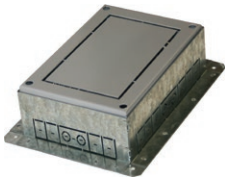
SPOJNA PRIRUBNICA PODNE KUTIJE MT 7

RB31

- spojna prirubnica podne kutije za poklopac MT 7
- metalna, galvanizirana
- za ugradnju u pod ili dvostruki pod
- prilagodljiva visina 95-125 mm
- sukladno normama EN 50085-1 i EN 50085-2-2

FLOOR BOX FLANGE MT 7

- floor box flange for box cover MT 7
- metal, galvanized
- for installation in a floor or double floor
- adjustable height 95-125mm
- in accordance with EN 50085-1 and EN 50085-2-2

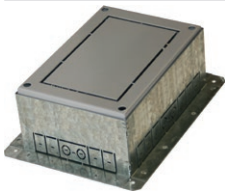
SPOJNA PRIRUBNICA PODNE KUTIJE MT 7 H = 88mm

RB41

- spojna prirubnica podne kutije za poklopac MT 7 H = 88 mm
- metalna, galvanizirana
- za ugradnju u pod ili dvostruki pod
- prilagodljiva visina 125-150mm
- sukladno normama EN 50085-1 i EN 50085-2-2

FLOOR BOX FLANGE MT 7 H=88mm

- floor box flange for box cover MT 7 H=88mm
- metal, galvanized
- for installation in a floor or double floor
- adjustable height 125-150mm
- in accordance with EN 50085-1 and EN 50085-2-2

PODNA KUTIJA MT 14

RB33

- podna kutija MT 14
- metalna, srebrne boje RAL 9006
- nosači MODUL 2x7M ugrađeni
- ugradne dimenzije 230x230 mm, dubina min. 95 mm
- debljina podne obloge poklopca do 10 mm
- sukladno normama EN 50085-1 i EN 50085-2-2

FLOOR BOX MT 14

- floor box MT 14
- metal, colour silver RAL 9006
- mounting frames MODUL 2x7M included
- mounting dimensions 230x230mm, depth min 95mm
- floor lining thickness up to 10mm
- in accordance with EN 50085-1 and EN 50085-2-2

PODNA KUTIJA MT 14 H = 88mm

RB43

- podna kutija MT 14
- metalna, srebrne boje RAL 9006
- nosači MODUL 2x7M ugrađeni
- ugradne dimenzije 230x230 mm, dubina min. 120mm
- debljina podne obloge poklopca do 10 mm
- sukladno normama EN 50085-1 i EN 50085-2-2

FLOOR BOX MT 14 H=88mm

- floor box MT 14
- metal, colour silver RAL 9006
- mounting frames MODUL 2x7M included
- mounting dimensions 230x230mm, depth min 120mm
- floor lining thickness up to 10mm
- in accordance with EN 50085-1 and EN 50085-2-2

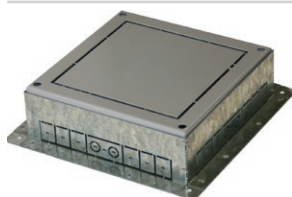

RB34

SPOJNA PRIRUBNICA PODNE KUTIJE MT 14

- spojna prirubnica podne kutije za poklopac MT 14
- metalna, galvanizirana
- za ugradnju u pod ili dvostruki pod
- prilagodljiva visina 95-125 mm
- sukladno normama EN 50085-1 i EN 50085-2-2

FLOOR BOX FLANGE MT 14

- floor box flange for box cover MT 14
- metal, galvanized
- for installation in a floor or double floor
- adjustable height 95-125mm
- in accordance with EN 50085-1 and EN 50085-2-2

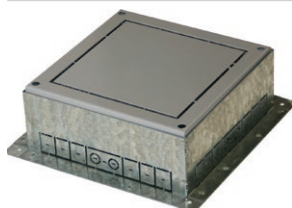

RB44

SPOJNA PRIRUBNICA PODNE KUTIJE MT 14 H = 88mm

- spojna prirubnica podne kutije za poklopac MT 14 H = 88 mm
- metalna, galvanizirana
- za ugradnju u pod ili dvostruki pod
- prilagodljiva visina 125-150mm
- sukladno normama EN 50085-1 i EN 50085-2-2

FLOOR BOX FLANGE MT 14 H=88mm

- floor box flange for box cover MT 14 H=88mm
- metal, galvanized
- for installation in a floor or double floor
- adjustable height 125-150mm
- in accordance with EN 50085-1 and EN 50085-2-2



RB36

PODNA KUTIJA MT 21

- podna kutija MT 21
- metalna, srebrne boje RAL 9006
- nosači MODUL 3x7M ugrađeni
- ugradne dimenzije 320x230 mm, dubina min. 95 mm
- debljina podne obloge poklopca do 10 mm
- sukladno normama EN 50085-1 i EN 50085-2-2

FLOOR BOX MT 21

- floor box MT 21
- metal, colour silver RAL 9006
- mounting frames MODUL 3x7M included
- mounting dimensions 320x230mm, depth min 95mm
- floor lining thickness up to 10mm
- in accordance with EN 50085-1 and EN 50085-2-2



RB46

PODNA KUTIJA MT 21 H = 88mm

- podna kutija MT 21
- metalna, srebrne boje RAL 9006
- nosači MODUL 3x7M ugrađeni
- ugradne dimenzije 320x230 mm, dubina min. 120mm
- debljina podne obloge poklopca do 10 mm
- sukladno normama EN 50085-1 i EN 50085-2-2

FLOOR BOX MT 21 H=88mm

- floor box MT 21
- metal, colour silver RAL 9006
- mounting frames MODUL 3x7M included
- mounting dimensions 320x230mm, depth min 120mm
- floor lining thickness up to 10mm
- in accordance with EN 50085-1 and EN 50085-2-2

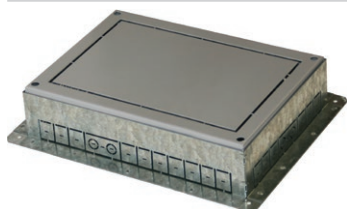

RB37

SPOJNA PRIRUBNICA PODNE KUTIJE MT 21

- spojna prirubnica podne kutije za poklopac MT 21
- metalna, galvanizirana
- za ugradnju u pod ili dvostruki pod
- prilagodljiva visina 95-125 mm
- sukladno normama EN 50085-1 i EN 50085-2-2

FLOOR BOX FLANGE MT 21

- floor box flange for box cover MT 21
- metal, galvanized
- for installation in a floor or double floor
- adjustable height 95-125mm
- in accordance with EN 50085-1 and EN 50085-2-2

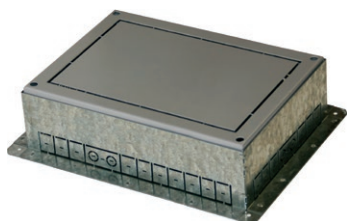

RB47

SPOJNA PRIRUBNICA PODNE KUTIJE MT 21 H = 88mm

- spojna prirubnica podne kutije za poklopac MT 21 H = 88 mm
- metalna, galvanizirana
- za ugradnju u pod ili dvostruki pod
- prilagodljiva visina 125-150mm
- sukladno normama EN 50085-1 i EN 50085-2-2

FLOOR BOX FLANGE MT 21 H=88mm

- floor box flange for box cover MT 21 H=88mm
- metal, galvanized
- for installation in a floor or double floor
- adjustable height 125-150mm
- in accordance with EN 50085-1 and EN 50085-2-2

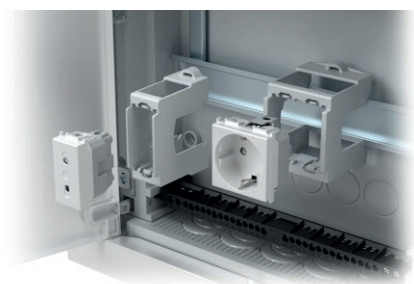

RB20

tip type	naziv description	tehnički podaci technical data
RB10	ADAPTER ZA DIN TRAČNICU ADAPTER FOR DIN RAIL	35mm 1M
RB11	ADAPTER ZA DIN TRAČNICU ADAPTER FOR DIN RAIL	35mm 2M
RB20	RAZDJELNI ORMARIĆ DISTRIBUTION BOX	MO 12+2
⋮	⋮	⋮

ADAPTER ZA DIN TRAČNICU 35mm 1M



RB10

- adapter MODUL 1M
- za Din tračnicu 35 mm
- sukladno normi EN 50022

ADAPTER FOR DIN RAIL 35mm 1M

- adapter MODUL 1M
- for DIN rail 35mm
- in accordance with EN 50022

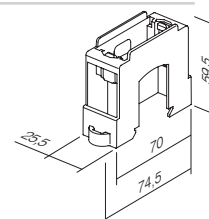

ADAPTER ZA DIN TRAČNICU 35mm 2M



RB11

- adapter MODUL 2M
- za Din tračnicu 35 mm
- sukladno normi EN 50022

ADAPTER FOR DIN RAIL 35mm 2M

- adapter MODUL 2M
- for DIN rail 35mm
- in accordance with EN 50022

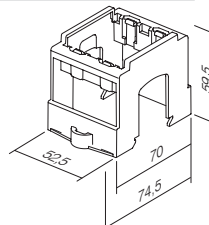

RAZDJELNI ORMARIĆ MO 12 + 2



- RB20
- razdjelni ormarić MO jedan red 12+2MU
 - 400V ~, razred II, IP40
 - metalna vratašca i okvir, bijele boje RAL 9016
 - priloženi konektori za vod za uzemljenje i neutralni vod
 - ugradnja u zid od opeke
 - sukladno normama EN 60670-1 i IEC 60670-24

DISTRIBUTION BOX MO 12+2

- distribution box MO single row 12+2MU
- 400V~, Class II, IP40
- metal leveling frame and door, colour white RAL 9016
- neutral and earth conductor terminals enclosed
- for brick wall mounting
- in accordance with EN 60670-1 and IEC 60670-24

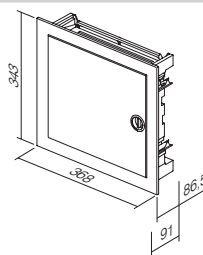

- RB20V0
- ugradnja u šuplje zidove
 - for hollow wall mounting

RAZDJELNI ORMARIĆ MO 24 +4



- RB21
- razdjelni ormarić MO dva reda 24+4MU
 - 400V ~, razred II, IP40
 - metalna vratašca i okvir, bijele boje RAL 9016
 - priloženi konektori za vod za uzemljenje i neutralni vod
 - ugradnja u zid od opeke
 - sukladno normama EN 60670-1 i IEC 60670-24

DISTRIBUTION BOX MO 24+4

- distribution box MO double row 24+4MU
- 400V~, Class II, IP40
- metal leveling frame and door, colour white RAL 9016
- neutral and earth conductor terminals enclosed
- for brick wall mounting
- in accordance with EN 60670-1 and IEC 60670-24

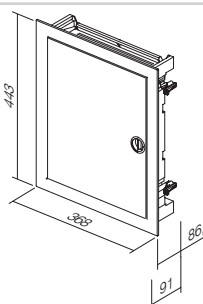

- RB21V0
- ugradnja u šuplje zidove
 - for hollow wall mounting

RAZDJELNI ORMARIĆ MO 36 +6



- RB22
- razdjelni ormarić MO tri reda 36+6MU
 - 400V ~, razred II, IP40
 - metalna vratašca i okvir, bijele boje RAL 9016
 - priloženi konektori za vod za uzemljenje i neutralni vod
 - ugradnja u zid od opeke
 - sukladno normama EN 60670-1 i IEC 60670-24

DISTRIBUTION BOX MO 36+6

- distribution box MO triple row 36+6 MU
- 400V~, Class II, IP40
- metal leveling frame and door, colour white RAL 9016
- neutral and earth conductor terminals enclosed
- for brick wall mounting
- in accordance with EN 60670-1 and IEC 60670-24

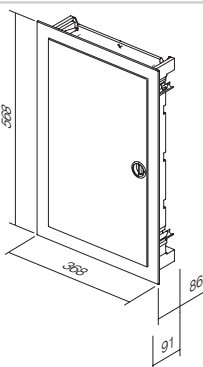

- RB22V0
- ugradnja u šuplje zidove
 - for hollow wall mounting

RAZDJELNI ORMARIĆ MO 48 +8



- RB23
- razdjelni ormarić MO četiri reda 48+8MU
 - 400V ~, razred II, IP40
 - metalna vratašca i okvir, bijele boje RAL 9016
 - priloženi konektori za vod za uzemljenje i neutralni vod
 - ugradnja u zid od opeke
 - sukladno normama EN 60670-1 i IEC 60670-24

DISTRIBUTION BOX MO 48+8

- distribution box MO quad row 48+8 MU
- 400V~, Class II, IP40
- metal leveling frame and door, colour white RAL 9016
- neutral and earth conductor terminals enclosed
- for brick wall mounting
- in accordance with EN 60670-1 and IEC 60670-24

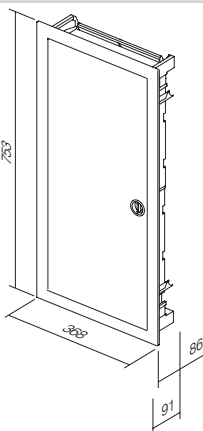

- RB23V0
- ugradnja u šuplje zidove
 - for hollow wall mounting

distribucija

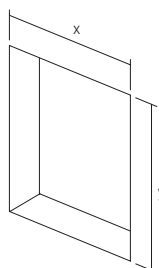

	RB20 RB20V0	RB21 RB21V0	RB22 RB22V0	RB23 RB23V0
x	314	314	314	314
y	314	414	539	724



ekonomik[®]



Planned for excellence
Style is essential



ERGO

METAL

SOFT

Neutralan, kompaktan, elegantan dizajn može se prilagoditi svakom okruženju u kojem boravite ili radite. Ne odstupa od interijera, nego se u njega harmonično uklapa.

A neutral, compact, elegant design is adjustable to every working or living area. It does not stick out from the interior, but rather harmonically fits into it.



ekonomik®



Planirano za savršenstvo Stil je bitan



Čista linija nježno je zaobljena – dobro osmišljena ergonomija posebno za vas.

A pure line is slightly curved - well considered ergonomics especially for you.



Možete birati između sjajnih reflektirajućih površina i suvremenoga metalnog izgleda.

You can choose between shiny reflective surfaces and modern metallic look.



Mekoća oblika pronaći će svoje mjesto, kako u modernim interijerima tako i u onim klasičnim.

The softness of the form will find its place in modern as well as in classic interiors.

HARMONY

REFLEX

UV PROTECT

Želje mogu biti vrlo različite. Stoga smo za vas pomno odabrali mogućnosti koje vam pružaju pravi odgovor. Neutralna paleta boja dodatno će ispuniti vaš ambijent – neće vas ograničavati.

Desires can be very different. Therefore we have carefully selected possibilities for you, which can offer you the right answer. A neutral palette of colours will only complement your ambient - it will not restrict it.

Press and the world will spring to life
Colourful landscape between walls



Doživljaj refleksije pružit će vam sjajni metali od polimera u bijeloj i bež boji.

Shiny polymer materials in white and beige colours enable reflective mood.



Odabrani dekorativni metalni sloj istovremeno je i moderan i neutralan.

Selected decorative metallic coat is at the same time modern and neutral.

Pritisnite i svijet će oživjeti Šareni krajolik između zidova



Za sve vas, koji se želite igrati pastelnim bojama, Ekonomik Colour idealno je rješenje.

For those who want to play with pastel colours Ekonomik Color represents a perfect solution.



Robusnost i velika otpornost na vanjske utjecaje (UV) osigurane su duroplastičnim materijalom (linija Colour).

Robustness and high resistance to external effects (UV) are secured by duroplastic materials (Color line).

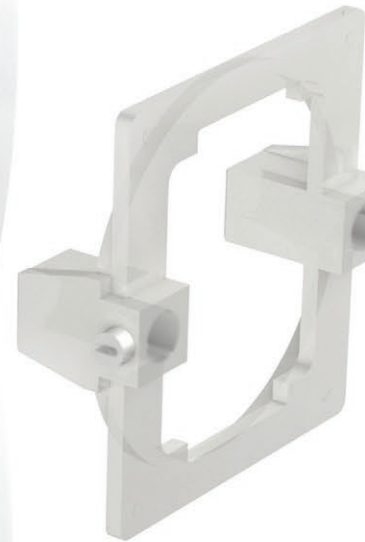
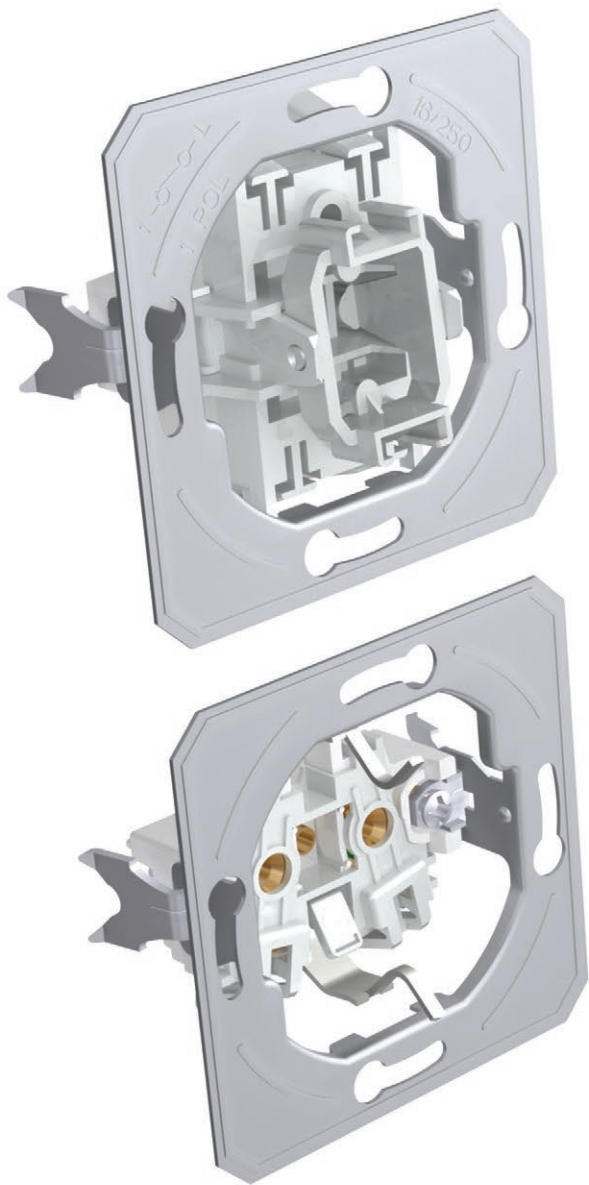

VERTICAL

HORIZONTAL

SAVE SPACE



Pri sastavljanju sačuvajte prostor na zidu. Ako raspoložete s malo prostora, prava je odluka „okomito“.

With combining you save space on the wall. When faced with a limited space, »vertically« is the right decision.



Kombinirajte prema vlastitoj želji.

Combine as you please.



Vidljivi elementi mogu se jednostavno demontirati. Bit će vam zahvalni i majstori.

Visible elements can be easily taken apart. Painters will be grateful to you.



Prolonge your day with a touch
Simplified living

Produžite svoj dan dodirom Za jednostavniji život

Ekonomik je rješenje za sustav standardnih okruglih kutija. Pomoću njega možemo planirati kako jednostavne instalacije, novogradnje i adaptacije tako i one zahtjevnije. Sustav karakterizira spajanje bez upotrebe vijaka što će vam uštedjeti vrijeme pri ugradnji elemenata.

Ekonomik is a solution for the system of standardized round installations boxes. It can be used for simple as well as more demanding installations, new buildings and adaptations. The system is characterised by plug-in contacts which save time during installation of elements.

Osjećajte se ugodno u sigurnom skloništu Potpuno povjerenje u dobru izgradnju

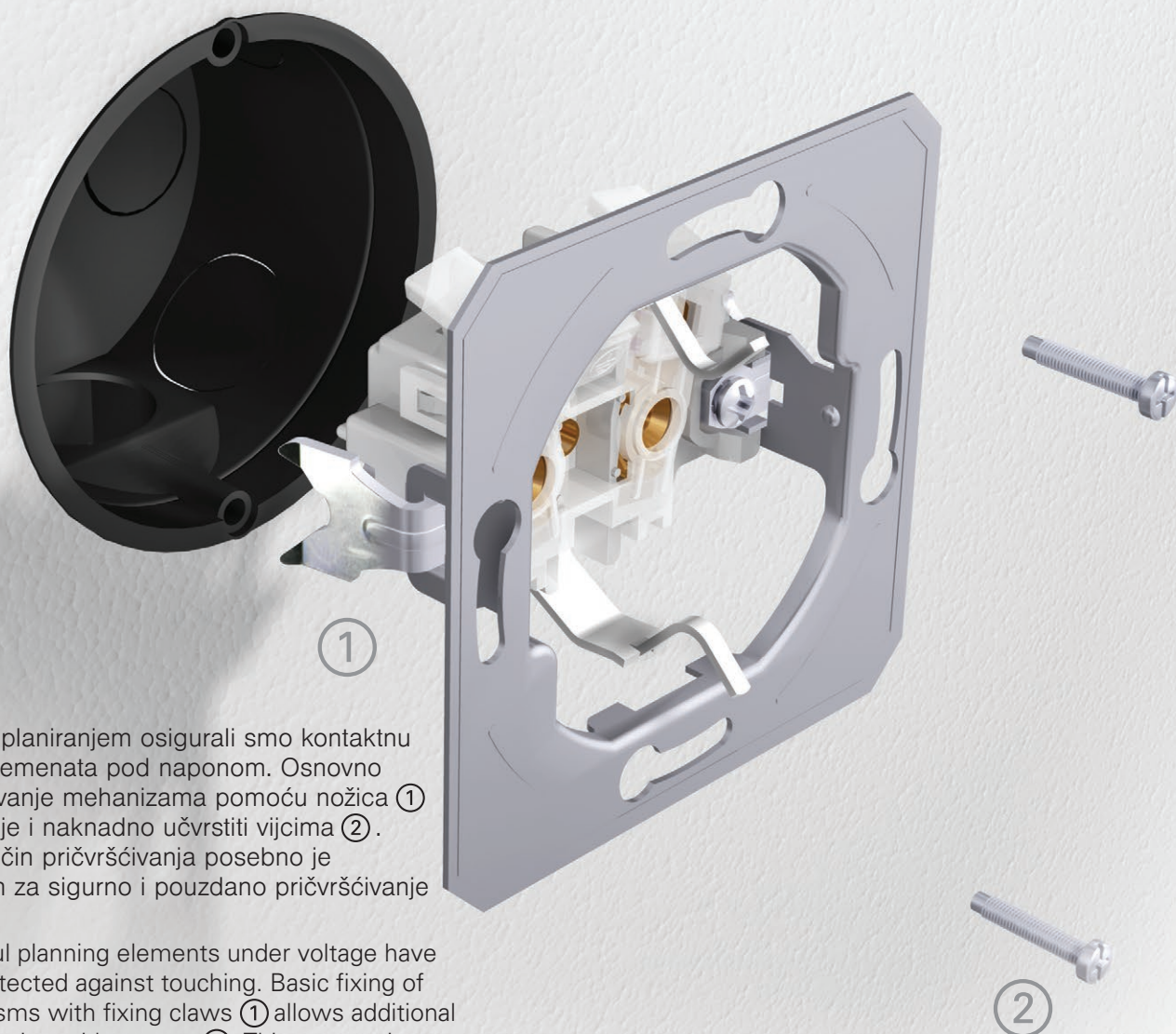

Pomnim planiranjem osigurali smo kontaktnu zaštitu elemenata pod naponom. Osnovno pričvršćivanje mehanizama pomoću nožica ① moguće je i naknadno učvrstiti vijcima ②. Takav način pričvršćivanja posebno je primjeren za sigurno i pouzdano pričvršćivanje utičnica.

By careful planning elements under voltage have been protected against touching. Basic fixing of mechanisms with fixing claws ① allows additional strengthening with screws ②. This manner is especially appropriate for safe and reliable fixing of sockets.

SIMPLE

FAST

FLEX

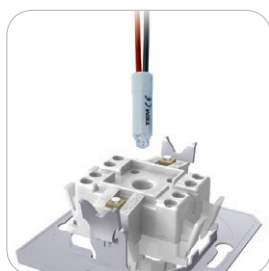

Dobro osmišljena konstrukcija sklopki omogućava također i jednostavno dodatno osvjetljenje.

A well-planned switch construction makes easy illumination possible also subsequently.



Spajanje bez vijaka omogućava brzo i pouzdano priključenje vodiča. Na isti se kontakt mogu pričvrstiti dva vodiča različitih presjeka.

Plug-in contacts enable quick and reliable attachment of wires. Two wires of different diameters can be attached to the same contact.

Montažne kutije olakšat
 će vam posao ugradnje.
 Zajamčene su odgovarajuće
 duljine.
 Easy-fitting installation boxes
 will make your work easier.
 Proper lengths are guaranteed.



Feeling well in a safe shelter
 Total confidence in a good construction

SAFE

THRUST

CERTIFIED



Sklopke su testirane prema
 međunarodnim standardima
 koji jamče sigurnost i dug
 vijek trajanja.

Switches were tested
 according to international
 standards which guarantee
 safety and long life span.



Pouzdanost preklopa
 osiguravaju kontakti izrađeni
 od srebrne legure (AgNi).

Contacts made of silver
 alloy (Ag-Ni) guarantee
 safe switching.

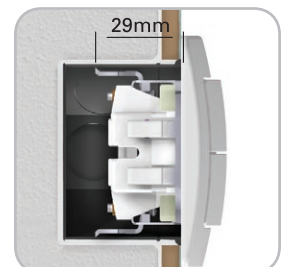

Nožice omogućavaju dublje
 pričvršćivanje (i preko
 keramičkih pločica i sl.)

Fixing claws enable deeper
 fixing (also through ceramic
 tiles, etc.)











Sve sklopke na prednjoj strani
 nose vidljivu oznaku.

All switches have a clear
 identification in the back.







TEM

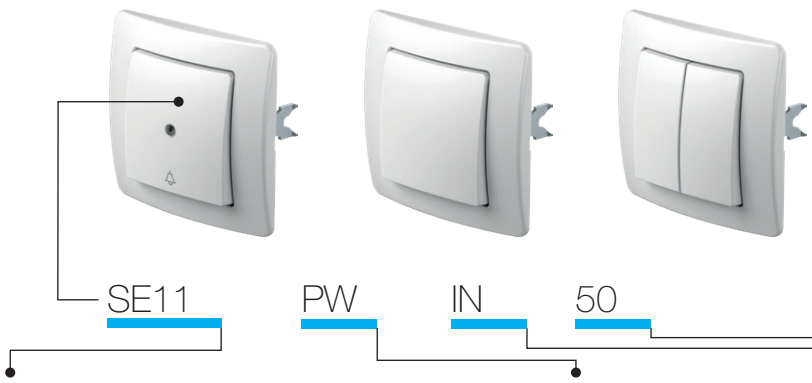



<i>SKLOPKE SE</i> <i>SWITCHES SE</i>		188
<i>TIPKE TE</i> <i>BUTTONS TE</i>		192
<i>OSVJETLJENJE IA</i> <i>ILLUMINATION IA</i>		193
<i>UTIČNICE VE</i> <i>SOCKETS VE</i>		196
<i>KOMUNIKACIJE KE</i> <i>COMMUNICATIONS KE</i>		199
<i>POKLOPCI PE</i> <i>COVERS PE</i>		204
<i>ELEKTRONIKA EE</i> <i>ELECTRONICS EE</i>		205
<i>PRIBOR AE</i> <i>ACCESSORIES AE</i>		210
<i>OKVIRI OE</i> <i>SURROUNDS OE</i>		212



tip type	naziv description	tehnički podaci technical data	boja colour	opcijski podaci 1 optional data 1	opcijski podaci 2 optional data 2
SE10	SKLOPKA JEDNOPOLNA SWITCH 1WAY	10AX 250V~	<input type="checkbox"/> PW bijela sjajna polar white	 NT neutralna neutral	 50
SE11	TIPKALO JEDNOPOLNO PUSH BUTTON 1WAY	10A 250V~	<input type="checkbox"/> IW bež sjajna ivory white	 IN indikator indicator	 51
SE22	SKLOPKA DVOPOLNA SWITCH 2POLE	16AX 250V~	<input type="checkbox"/> ES srebrna mat elox silver		 03
...	<input type="checkbox"/> CO bijeli duroplast white thermoset		 04
...	<input type="checkbox"/> NB crna sjajna night black		 04

SKLOPKA JEDNOPOLNA 10AX 250V ~

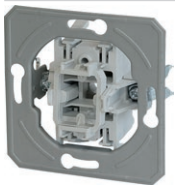

SE10

- 10AX 250V~, tip SE10
- sukladno normi EN 60669-1
- bezvičani kontakti 1,5-2,5mm²



SWITCH 1WAY 10AX 250V~

- 10AX 250V~, type SE10
- in accordance with EN 60669-1
- plug-in contacts 1.5-2.5mm²

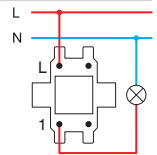

TIPKALO JEDNOPOLNO 10A 250V ~



SE11

- 10A 250V~, tip SE11
- sukladno normi EN 60669-1
- bezvičani kontakti 1,5-2,5mm²

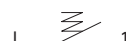

PUSH BUTTON 1WAY 10A 250V~

- 10A 250V~, type SE11
- in accordance with EN 60669-1
- plug-in contacts 1.5-2.5mm²

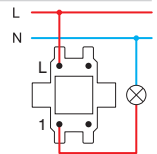

SKLOPKA DVOPOLNA 16AX 250V ~



SE22

- 16AX 250V~, tip SE22
- sukladno normi EN 60669-1
- vijčano pričvršćivanje vodiča presjeka 1,5-2 5mm²
- samo u kombinaciji s tipkom TE10__NT03

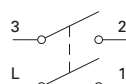

SWITCH 2POLE 16AX 250V~

- 16AX 250V~, type SE22
- in accordance with EN 60669-1
- screw contacts 1.5-2.5mm²
- only in combination with button TE10__NT03

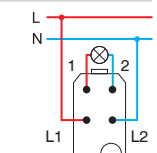

SKLOPKA SERIJSKA JEDNOPOLNA 10AX 250V ~



SE50

- 10AX 250V~, tip SE50
- sukladno normi EN 60669-1
- bezvičani kontakti 1,5-2,5mm²



SWITCH 2GANG-1WAY 10AX 250V~

- 10AX 250V~, type SE50
- in accordance with EN 60669-1
- plug-in contacts 1.5-2.5mm²

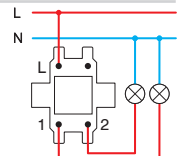

TIPKALO SERIJSKO-JEDNOPOLNO 10A 250V ~



SE51

- 10A 250V~, tip SE51
- skladno normi EN 60669-1
- bezvijčani kontakti 1,5-2,5mm²

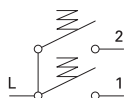

PUSH BUTTON 2GANG-1WAY 10A 250V~

- 10A 250V~, type SE51
- in accordance with EN 60669-1
- plug-in contacts 1.5-2.5mm²

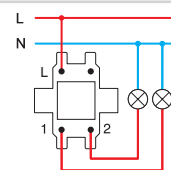

SKLOPKA ŽALUZIJSKA 10AX 250V ~



SE52

- 10AX 250V~, tip SE52
- skladno normi EN 60669-1
- bezvijčani kontakti 1,5-2,5mm²
- s mehaničkom blokodom

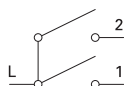

SWITCH SHUTTERS 10AX 250V~

- 10AX 250V~, type SE52
- in accordance with EN 60669-1
- plug-in contacts 1.5-2.5mm²
- with mechanical interblock

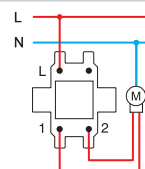

TIPKALO ŽALUZIJSKO 10A 250V ~



SE53

- 10A 250V~, tip SE53
- skladno normi EN 60669-1
- bezvijčani kontakti 1,5-2,5mm²
- s mehaničkom blokodom

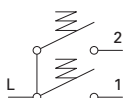

PUSH BUTTON SHUTTERS 10A 250V~

- 10A 250V~, type SE53
- in accordance with EN 60669-1
- plug-in contacts 1.5-2.5mm²
- with mechanical interblock

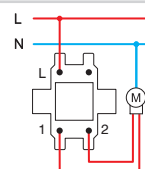

SKLOPKA IZMJENIČNA 10AX 250V ~



SE60

- 10AX 250V~, tip SE60
- skladno normi EN 60669-1
- bezvijčani kontakti 1,5-2,5mm²

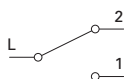

SWITCH 2WAY 10AX 250V~

- 10AX 250V~, type SE60
- in accordance with EN 60669-1
- plug-in contacts 1.5-2.5mm²

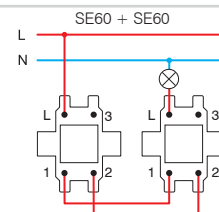

SKLOPKA IZMJENIČNA DVOSTRUKA 10AX 250V ~



SE63

- 10AX 250V~, tip SE63
- skladno normi EN 60669-1
- bezvijčani kontakti 1,5-2,5mm²



SWITCH DOUBLE 2WAY 10AX 250V~

- 10AX 250V~, type SE63
- in accordance with EN 60669-1
- plug-in contacts 1.5-2.5mm²

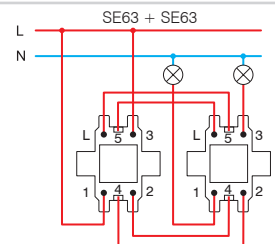

SKLOPKA KRIŽNA 10AX 250V ~



SE70

- 10AX 250V~, tip SE70
- skladno normi EN 60669-1
- bezvijčani kontakti 1,5-2,5mm²



SWITCH INTERMEDIATE 10AX 250V~

- 10AX 250V~, type SE70
- in accordance with EN 60669-1
- plug-in contacts 1.5-2.5mm²

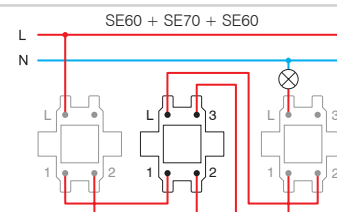

SKLOPKA JEDNOPOLNA 10AX 250V ~



- SE10PW
- SE10IW
- SE10ES
- SE10CO
- SE10NB

- 10AX 250V~, tip SE10
- sukladno normi EN 60669-1
- bezvijčani kontakti 1,5-2,5mm²

SWITCH 1WAY 10AX 250V~
- 10AX 250V~, type SE10
- in accordance with EN 60669-1
- plug-in contacts 1.5-2.5mm²



SKLOPKA JEDNOPOLNA 10AX 250V ~ __ IN



- SE10PWIN
- SE10IWIN
- SE10ESIN
- SE10COIN
- SE10NBIN

- IN indikator
- 10AX 250V~, tip SE10
- sukladno normi EN 60669-1
- bezvijčani kontakti 1,5-2,5mm²

SWITCH 1WAY 10AX 250V~ __ IN
- IN indicator
- 10AX 250V~, type SE10
- in accordance with EN 60669-1
- plug-in contacts 1.5-2.5mm²



TIPKALO JEDNOPOLNO 10A 250V ~



- SE11PW
- SE11IW
- SE11ES
- SE11CO
- SE11NB

- 10A 250V~, tip SE11
- sukladno normi EN 60669-1
- bezvijčani kontakti 1,5-2,5mm²

PUSH BUTTON 1WAY 10A 250V~
- 10A 250V~, type SE11
- in accordance with EN 60669-1
- plug-in contacts 1.5-2.5mm²



TIPKALO JEDNOPOLNO 10A 250V ~ __ TI 50



- SE11PWTI50
- SE11IWTI50
- SE11ESTI50
- SE11COTI50
- SE11NBTI50

- TI 50 indikator zvono + neonska tinjalica
- 10A 250V~, tip SE11
- sukladno normi EN 60669-1
- bezvijčani kontakti 1,5-2,5mm²

PUSH BUTTON 1WAY 10A 250V~ __ TI 50
- TI 50 indicator bell+neon lamp
- 10A 250V~, type SE11
- in accordance with EN 60669-1
- plug-in contacts 1.5-2.5mm²



TIPKALO JEDNOPOLNO 10A 250V ~ __ TI 51



- SE11PWTI51
- SE11IWTI51
- SE11ESTI51
- SE11COTI51
- SE11NBTI51

- TI 51 indikator svjetlo + neonska tinjalica
- 10A 250V~, tip SE11
- sukladno normi EN 60669-1
- bezvijčani kontakti 1,5-2,5mm²

PUSH BUTTON 1WAY 10A 250V~ __ TI 51
- TI 51 indicator light+neon lamp
- 10A 250V~, type SE11
- in accordance with EN 60669-1
- plug-in contacts 1.5-2.5mm²



TIPKALO JEDNOPOLNO 10A 250V ~ __ IL



- SE11PWIL
- SE11IWIL
- SE11ESIL
- SE11COIL
- SE11NBIL

- IL natpisna pločica
- 10A 250V~, tip SE11
- sukladno normi EN 60669-1
- bezvijčani kontakti 1,5-2,5mm²

PUSH BUTTON 1WAY 10A 250V~ __ IL
- IL inscription plate
- 10A 250V~, type SE11
- in accordance with EN 60669-1
- plug-in contacts 1.5-2.5mm²



SKLOPKA DVOPOLNA 16AX 250V ~ __ IN 03



- SE22PWIN03
- SE22IWIN03
- SE22ESIN03
- SE22NBIN03

- IN 03 neutralna 0-1
- 16AX 250V~, tip SE22
- sukladno normi EN 60669-1
- vijčano pričvršćivanje vodiča presjeka 1,5-2,5mm²

SWITCH 2POLE 16AX 250V~ __ IN 03
- IN 03 neutral 0-1
- 16AX 250V~, type SE22
- in accordance with EN 60669-1
- screw contacts 1.5-2.5mm²



SKLOPKA SERIJSKA-JEDNOPOLNA 10AX 250V ~



- SE50PW
- SE50IW
- SE50ES
- SE50CO
- SE50NB

- 10AX 250V~, tip SE50
- skladno normi EN 60669-1
- bezvijčani kontakti 1,5-2,5mm²

SWITCH 2GANG-1WAY 10AX 250V~

- 10AX 250V~, type SE50
- in accordance with EN 60669-1
- plug-in contacts 1.5-2.5mm²



TIPKALO SERIJSKO-JEDNOPOLNO 10A 250V ~



- SE51PW
- SE51IW
- SE51ES
- SE51CO
- SE51NB

- 10A 250V~, tip SE51
- skladno normi EN 60669-1
- bezvijčani kontakti 1,5-2,5mm²

PUSH BUTTON 2GANG-1WAY 10A 250V~

- 10A 250V~, type SE51
- in accordance with EN 60669-1
- plug-in contacts 1.5-2.5mm²



SKLOPKA ŽALUZIJSKA 10AX 250V ~ __ NT 09



- SE52PWNT09
- SE52IWNT09
- SE52ESNT09
- SE52CONT09
- SE52NBNT09

- NT 09 neutralno gore-dolje
- 10AX 250V~, tip SE52
- skladno normi EN 60669-1
- bezvijčano pričvrščivanje vodiča presjeka 1,5-2,5 mm²
- s mehaničkom blokado

SWITCH SHUTTERS 10AX 250V~ __ NT 09

- NT 09 neutral up-down
- 10AX 250V~, type SE52
- in accordance with EN 60669-1
- plug-in contacts 1.5-2.5mm²
- with mechanical interblock



TIPKALO ŽALUZIJSKO 10A 250V~ __ NT 09



- SE53PWNT09
- SE53IWNT09
- SE53ESNT09
- SE53CONT09
- SE53NBNT09

- NT 09 neutralno gore-dolje
- 10A 250V~, tip SE53
- skladno normi EN 60669-1
- bezvijčani kontakti 1,5-2,5mm²
- s mehaničkom blokado

PUSH BUTTON SHUTTERS 10A 250V~ __ NT 09

- NT 09 neutral up-down
- 10A 250V~, type SE53
- in accordance with EN 60669-1
- plug-in contacts 1.5-2.5mm²
- with mechanical interblock



SKLOPKA IZMJENIČNA 10AX 250V ~



- SE60PW
- SE60IW
- SE60ES
- SE60CO
- SE60NB

- 10AX 250V~, tip SE60
- skladno normi EN 60669-1
- bezvijčani kontakti 1,5-2,5mm²

SWITCH 2WAY 10AX 250V~

- 10AX 250V~, type SE60
- in accordance with EN 60669-1
- plug-in contacts 1.5-2.5mm²



SKLOPKA IZMJENIČNA DVOSTRUKA 10AX 250V ~



- SE63PW
- SE63IW
- SE63ES
- SE63CO
- SE63NB

- 10AX 250V~, tip SE63
- skladno normi EN 60669-1
- bezvijčani kontakti 1,5-2,5mm²

SWITCH DOUBLE 2WAY 10AX 250V~

- 10AX 250V~, type SE63
- in accordance with EN 60669-1
- plug-in contacts 1.5-2.5mm²



SKLOPKA KRIŽNA 10AX 250V ~



- SE70PW
- SE70IW
- SE70ES
- SE70CO
- SE70NB

- 10AX 250V~, tip SE70
- skladno normi EN 60669-1
- bezvijčani kontakti 1,5-2,5mm²

SWITCH INTERMEDIATE 10AX 250V~

- 10AX 250V~, type SE70
- in accordance with EN 60669-1
- plug-in contacts 1.5-2.5mm²

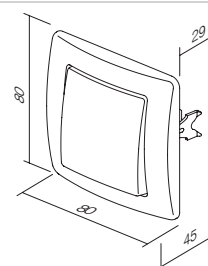
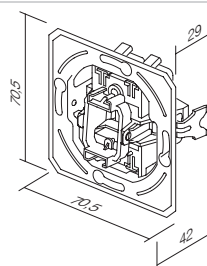

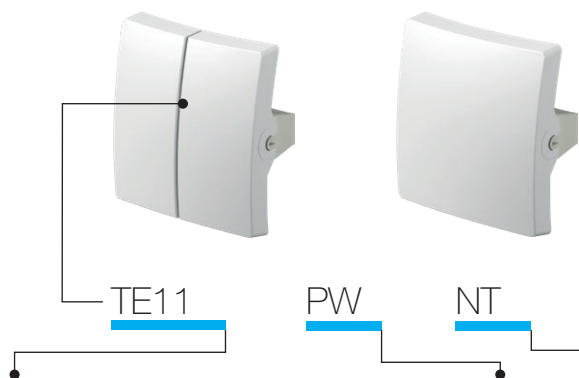

tip type	naziv description	boja colour	opcijski podaci 1 optional data 1	opcijski podaci 2 optional data 2
TE10	TIPKA OBIČNA BUTTON 1GANG	<input type="checkbox"/> PW bijela sjajna polar white	NT neutralna neutral	50
TE11	TIPKA SERIJSKA BUTTON 2GANG	<input type="checkbox"/> IW bež sjajna ivory white	IN indikator indicator	51
...	...	<input type="checkbox"/> ES srebrna mat elox silver		03
...	...	<input type="checkbox"/> CO bijeli duroplast white thermoset		04
...	...	<input type="checkbox"/> NB crna sjajna night black		...

TIPKA OBIČNA



- TE10PW
- TE10IW
- TE10ES
- TE10CO
- TE10NB

- tipka zajedno s nosačem
BUTTON 1GANG
- button together with carrier



TIPKA INDIKATOR

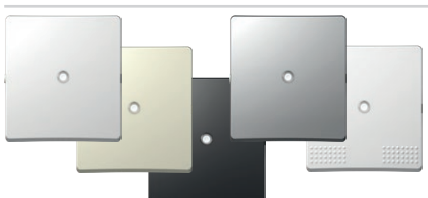

- TE10PIN
- TE10IWIN
- TE10ESIN
- TE10COIN
- TE10NBIN

- tipka zajedno s nosačem
BUTTON INDICATOR
- button together with carrier



TIPKA S NATPISNOM PLOČICOM

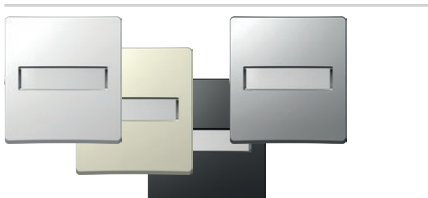

- TE13PWIL
- TE13IWIL
- TE13ESIL
- TE13NBIL

- tipka zajedno s nosačem, s natpisnom pločicom
BUTTON WITH INSCRIPTION PLATE
- button together with carrier, with inscription plate



TIPKA SERIJSKA



- TE11PW
- TE11IW
- TE11ES
- TE11CO
- TE11NB

- tipka serijska zajedno s nosačem
BUTTON 2GANG
- button 2gang together with carrier

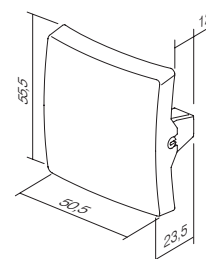
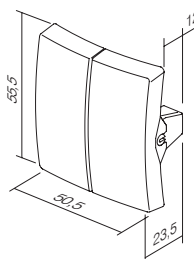

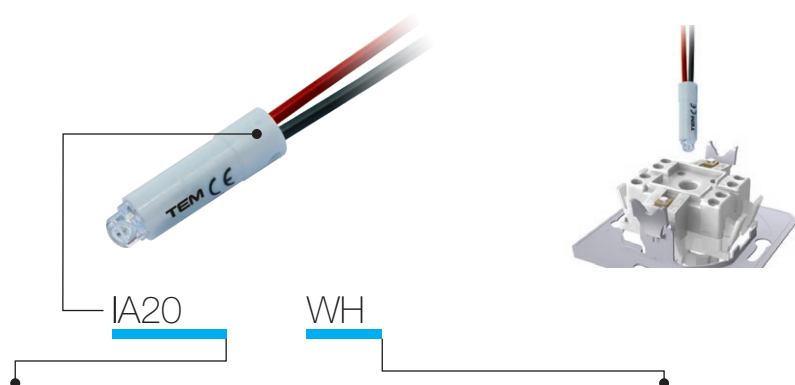

tip type	naziv description	tehnički podaci technical data	boja colour
IA10	NEONSKA TINJALICA NEON LAMP	230V~ 0,34W	<input type="checkbox"/> WH bijela white
IA20	LED TINJALICA LED LAMP	230V~ 0,40W	<input checked="" type="checkbox"/> BL plava blue
IA21	LED TINJALICA LED LAMP	24V AC/DC 0,20W	<input checked="" type="checkbox"/> RD crvena red
·	·	·	<input checked="" type="checkbox"/> GR zelena green
·	·	·	<input checked="" type="checkbox"/> OR narančasta orange

NEONSKA TINJALICA 230V~ 0,34W

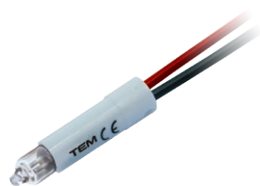

 IA10OR

- za indicaciju, osvjtljenje ili stalno osvjtljenje sklopke
- u kombinaciji s tipkom s indikatorom

NEON LAMP 230V~ 0,34W

- for indication, illumination or constant illumination of switch
- in combination with button with indicator

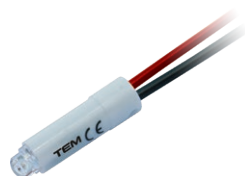
LED TINJALICA 230V AC/DC 0,40W



 IA20WH
 IA20GR
 IA20RD
 IA20BL

- za indicaciju, osvjtljenje ili stalno osvjtljenje sklopke
- u kombinaciji s tipkom s indikatorom

LED LAMP 230V AC/DC 0,40W

- for indication, illumination or constant illumination of switch
- in combination with button with indicator

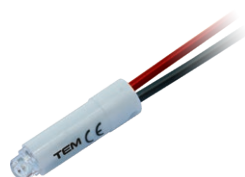
LED TINJALICA 24V AC/DC 0,20W

 IA21WH
 IA21RD

- za indicaciju, osvjtljenje ili stalno osvjtljenje sklopke
- u kombinaciji s tipkom s indikatorom

LED LAMP 24V AC/DC 0,20W

- for indication, illumination or constant illumination of switch
- in combination with button with indicator

LED TINJALICA 12V AC/DC 0,10W

 IA22WH
 IA22RD

- za indicaciju, osvjtljenje ili stalno osvjtljenje sklopke
- u kombinaciji s tipkom s indikatorom

LED LAMP 12V AC/DC 0,10W

- for indication, illumination or constant illumination of switch
- in combination with button with indicator

* Indikacija /
Indication

Rasvjetna tijela /
Illumination

* Osvjetljenje stalno uključeno /
Illumination always on

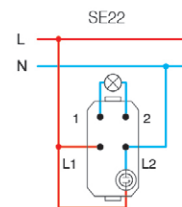
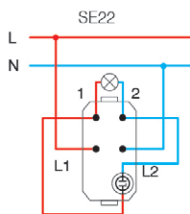
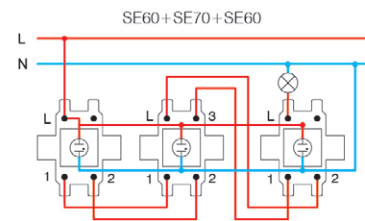
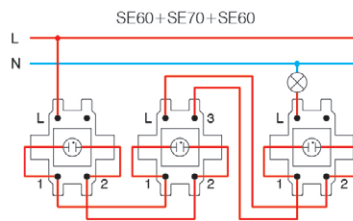
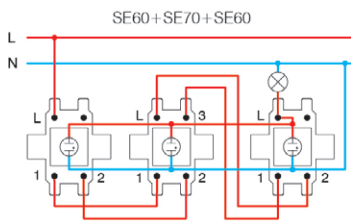
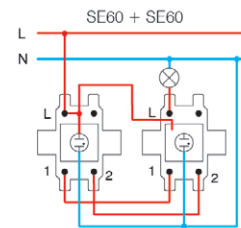
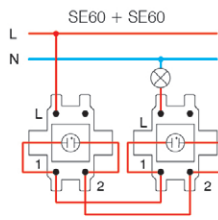
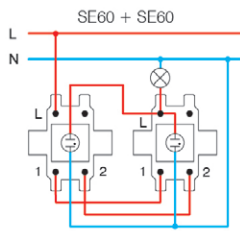
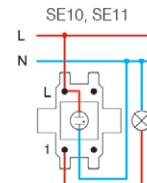
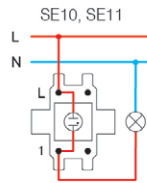
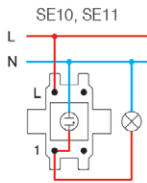

* spojne shema kompaktne fluorescentne tinjalice (CFL, LED) /
wiring scheme for energy saving lamps (CFL, LED)

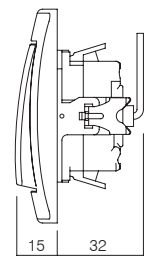

S O C K E T S V E

VE11 PT XO KS

tip type	naziv description	tehnički podaci technical data	opcijski podaci 1 optional data 1	opcijski podaci 2 optional data 2
VE10	ŠUKO UTIČNICA SOCKET SCHUKO	2P+E 16A 250V~	XO bez okvira without cover plate	KS zaštita za djecu child protection
VE11	ŠUKO UTIČNICA+POKLOPAC SOCKET SCHUKO+COVER	2P+E 16A 250V~		
VE12	ŠUKO UTIČNICA SOCKET SCHUKO	2P+E 16A 250V~ BV	KS zaštita za djecu child protection	
⋮	⋮	⋮		
⋮	⋮	⋮		

boja
colour

<input type="checkbox"/> PW bijela sjajna polar white	<input type="checkbox"/> PT bijela+prozirna white+transparent	<input type="checkbox"/> PP bijela+bijela white+white
<input type="checkbox"/> IW bež sjajna ivory white	<input type="checkbox"/> IT bež+prozirna ivory+transparent	<input type="checkbox"/> II bež+bež ivory+ivory
<input type="checkbox"/> ES srebrna mat elox silver	<input type="checkbox"/> ST srebrna+prozirna silver+transparent	<input type="checkbox"/> SS srebrna+srebrna silver+silver
<input type="checkbox"/> CO bijeli duroplast white thermoset	<input type="checkbox"/> CT bijela+prozirna white+transparent	<input type="checkbox"/> BB crna+crna black+black
<input type="checkbox"/> NB crna sjajna night black	<input type="checkbox"/> BT crna+prozirna black+transparent	<input type="checkbox"/> RR crvena+crvena red+red
<input type="checkbox"/> RD crvena red	<input type="checkbox"/> RT crvena+prozirna red+transparent	<input type="checkbox"/> GG zelena+zelena green+green
<input type="checkbox"/> GR zelena green	<input type="checkbox"/> GT zelena+prozirna green+transparent	<input type="checkbox"/> OO narančasta+narančasta orange+orange
<input type="checkbox"/> OR narančasta orange	<input type="checkbox"/> OT narančasta+prozirna orange+transparent	



šuko – sukladno normi EN 60884-1, CEE7 (lista standarda III)

francuska – sukladno normi NF C 61-314 (lista standarda V)

schuko - in accordance with EN 60884-1, CEE7 (standard sheet III)

French - in accordance with NF C 61-314 (standard sheet V)

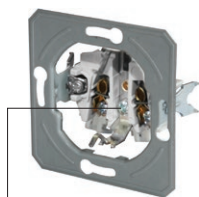
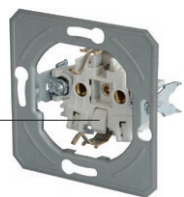
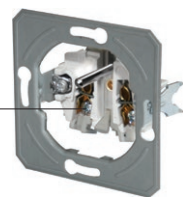
vijčano pričvršćivanje vodiča
screw contactsBV bezvijčano pričvršćivanje
BV plug-in contactsvijčano pričvršćivanje vodiča
screw contactsBV bezvijčano pričvršćivanje
BV plug-in contacts

UTIČNICA ŠUKO 2P + E 16A 250V ~ __ XO



- VE10PWXO
- VE10IWXO
- VE10ESXO
- VE10COXO
- VE10NBXO
- VE10RDXO
- VE10GRXO
- VE10ORXO

- vijčano pričvršćivanje vodiča presjeka 1,5-2,5mm²
- XO bez okvira
- 2P+E šuko
- 16A 250V~, tip VE10

SOCKET SCHUKO 2P+E 16A 250V~ __ XO

- screw contacts 1.5-2.5mm²
- XO without surround
- 2P+E schuko
- 16A 250V~, type VE10



UTIČNICA ŠUKO + POKLOPAC 2P + E 16A 250V ~ __ XO

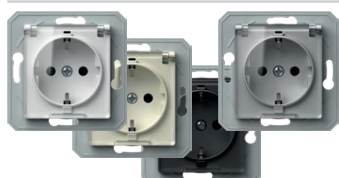

- VE11PTXO
- VE11ITXO
- VE11STXO
- VE11BTXO

- vijčano pričvršćivanje vodiča presjeka 1,5-2,5mm²
- XO bez okvira
- 2P+E šuko+poklopac
- 16A 250V~, tip VE11

SOCKET SCHUKO+COVER 2P+E 16A 250V~ __ XO

- screw contacts 1.5-2.5mm²
- XO without surround
- 2P+E schuko+cover
- 16A 250V~, type VE11



UTIČNICA ŠUKO 2P + E 16A 250V ~ BV __ XO



- VE12PWXO
- VE12IWXO
- VE12ESXO
- VE12COXO
- VE12NBXO
- VE12RDXO
- VE12GRXO
- VE12ORXO

- BV bezvijčani kontakti 1,5-2,5mm²
- XO bez okvira
- 2P+E šuko
- 16A 250V~, tip VE12

SOCKET SCHUKO 2P+E 16A 250V~ BV __ XO

- BV plug-in contacts 1.5-2.5mm²
- XO without surround
- 2P+E schuko
- 16A 250V~, type VE12



UTIČNICA ŠUKO + POKLOPAC 2P + E 16A 250V~ BV __ XO

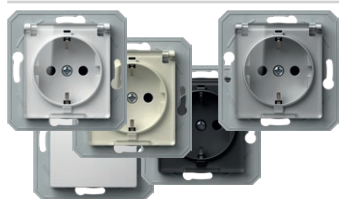

- VE13PTXO
- VE13ITXO
- VE13STXO
- VE13BTXO
- VE13PPXO

- BV bezvijčani kontakti 1,5-2,5mm²
- XO bez okvira
- 2P+E šuko+poklopac
- 16A 250V~, tip VE13

SOCKET SCHUKO+COVER 2P+E 16A 250V~ BV __ XO

- BV plug-in contacts 1.5-2.5mm²
- XO without surround
- 2P+E schuko+cover
- 16A 250V~, type VE13



UTIČNICA ŠUKO 2P + E 16A 250V ~



- VE10PW
- VE10IW
- VE10ES
- VE10CO
- VE10NB

- vijčano pričvršćivanje vodiča presjeka 1,5-2,5mm²
- 2P+E šuko
- 16A 250V~, tip VE10

SOCKET SCHUKO 2P+E 16A 250V~

- screw contacts 1.5-2.5mm²
- 2P+E schuko
- 16A 250V~, type VE10



UTIČNICA ŠUKO + POKLOPAC 2P + E 16A 250V~

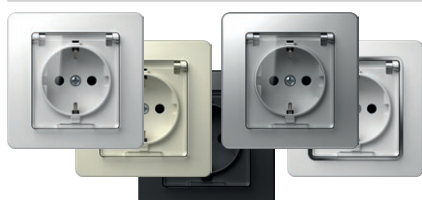

- VE11PT
- VE11IT
- VE11ST
- VE11CT
- VE11BT

- vijčano pričvršćivanje vodiča presjeka 1,5-2,5mm²
- 2P+E šuko+poklopac
- 16A 250V~, tip VE11

SOCKET SCHUKO+COVER 2P+E 16A 250V~

- screw contacts 1.5-2.5mm²
- 2P+E schuko+cover
- 16A 250V~, type VE11



UTIČNICA ŠUKO 2P + E 16A 250V ~ BV



- VE12PW
- VE12IW
- VE12ES
- VE12CO
- VE12NB

- BV bezvijčani kontakti 1,5-2,5mm²
- 2P+E šuko
- 16A 250V~, tip VE12

SOCKET SCHUKO 2P+E 16A 250V~ BV

- BV plug-in contacts 1.5-2.5mm²
- 2P+E schuko
- 16A 250V~, type VE12



UTIČNICA ŠUKO + POKLOPAC 2P + E 16A 250V ~ BV

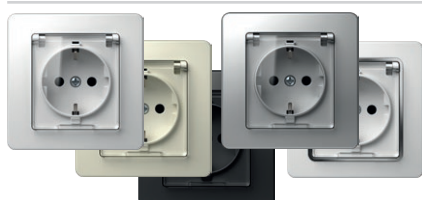

- VE13PT
- VE13IT
- VE13ST
- VE13CT
- VE13BT

- BV bezvijčani kontakti 1,5-2,5mm²
- 2P+E šuko+poklopac
- 16A 250V~, tip VE13

SOCKET SCHUKO+COVER 2P+E 16A 250V~ BV

- BV plug-in contacts 1.5-2.5mm²
- 2P+E schuko+cover
- 16A 250V~, type VE13



UTIČNICA FRANCUSKA 2P + E 16A 250V ~ __ XO



- VE40PWXO
- VE40IWXO
- VE40ESXO
- VE40COXO
- VE40NBXO
- VE40RDXO
- VE40GRXO
- VE40ORXO

- vijčano pričvršćivanje vodiča presjeka 1,5-2,5mm²
- XO bez okvira
- 2P+E francuska
- 16A 250V[~], tip VE40

SOCKET FRENCH 2P+E 16A 250V~ __ XO

- screw contacts 1.5-2.5mm²
- XO without surround
- 2P+E French
- 16A 250V[~], type VE40



UTIČNICA FRANCUSKA + POKLOPAC 2P + E 16A 250V~ __ XO

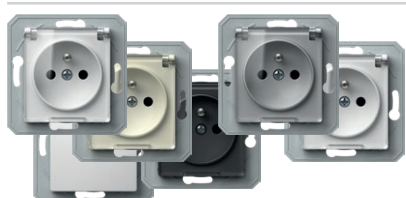

- VE41PTXO
- VE41ITXO
- VE41STXO
- VE41PTXO
- VE41BTXO
- VE41PPXO

- vijčano pričvršćivanje vodiča presjeka 1,5-2,5mm²
- XO bez okvira
- 2P+E francuska+poklopac
- 16A 250V[~], tip VE41

SOCKET FRENCH+COVER 2P+E 16A 250V~ __ XO

- screw contacts 1.5-2.5mm²
- XO without surround
- 2P+E French+cover
- 16A 250V[~], type VE41



UTIČNICA FRANCUSKA 2P + E 16A 250V~ BV __ XO



- VE42PWXO
- VE42IWXO
- VE42ESXO
- VE42COXO
- VE42NBXO
- VE42RDXO
- VE42GRXO
- VE42ORXO

- BV bezvijčani kontakti 1,5-2,5mm²
- XO bez okvira
- utičnica sa zaštitnim kontaktom francuska
- 16A 250V[~], tip VE42

SOCKET FRENCH 2P+E 16A 250V~ BV __ XO

- BV plug-in contacts 1.5-2.5mm²
- XO without surround
- 2P+E French
- 16A 250V[~], type VE42



UTIČNICA FRANCUSKA + POKLOPAC 2P + E 16A 250V~ BV __ XO

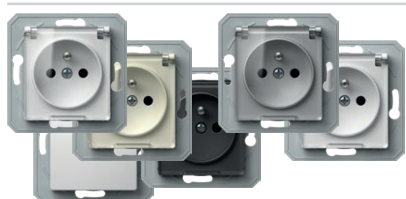

- VE43PTXO
- VE43ITXO
- VE43STXO
- VE43PTXO
- VE43BTXO
- VE43PPXO

- BV bezvijčani kontakti 1,5-2,5mm²
- XO bez okvira
- 2P+E francuska+poklopac
- 16A 250V[~], tip VE43

SOCKET FRENCH+COVER 2P+E 16A 250V~ BV __ XO

- BV plug-in contacts 1.5-2.5mm²
- XO without surround
- 2P+E French+cover
- 16A 250V[~], type VE43



UTIČNICA FRANCUSKA 2P + E 16A 250V ~



- VE40PW
- VE40IW
- VE40ES
- VE40CO
- VE40NB

- vijčano pričvršćivanje vodiča presjeka 1.5-2.5mm²
- 2P+E francuska
- 16A 250V[~], tip VE40

SOCKET FRENCH 2P+E 16A 250V~

- screw contacts 1.5-2.5mm²
- 2P+E French
- 16A 250V[~], type VE40



UTIČNICA FRANCUSKA + POKLOPAC 2P + E 16A 250V~



- VE41PT
- VE41IT
- VE41ST
- VE41CT
- VE41BT

- vijčano pričvršćivanje vodiča presjeka 1,5-2,5mm²
- 2P+E francuska+poklopac
- 16A 250V[~], tip VE41

SOCKET FRENCH+COVER 2P+E 16A 250V~

- screw contacts 1.5-2.5mm²
- 2P+E French+cover
- 16A 250V[~], type VE41



UTIČNICA FRANCUSKA 2P + E 16A 250V ~ BV



- VE42PW
- VE42IW
- VE42ES
- VE42CO
- VE42NB

- BV bezvijčani kontakti 1,5-2,5mm²
- utičnica sa zaštitnim kontaktom francuska
- 16A 250V[~], tip VE42

SOCKET FRENCH 2P+E 16A 250V~ BV

- BV plug-in contacts 1.5-2.5mm²
- 2P+E French
- 16A 250V[~], type VE42



UTIČNICA FRANCUSKA + POKLOPAC 2P + E 16A 250V ~ BV



- VE43PT
- VE43IT
- VE43ST
- VE43CT
- VE43BT

- BV bezvijčani kontakti 1,5-2,5mm²
- 2P+E francuska+poklopac
- 16A 250V[~], tip VE43

SOCKET FRENCH+COVER 2P+E 16A 250V~ BV

- BV plug-in contacts 1.5-2.5mm²
- 2P+E French+cover
- 16A 250V[~], type VE43





- VE16PWKS
- VE16IWKS
- VE16ESKS
- VE16NBKS

UTIČNICA ŠUKO DVOSTRUKA 2P + E 16A 250V~

- 2P+E šuko dvostruka
- 16A 250V~, tip VE16
- sukladno normama IEC 60884-1, CEE7
- vijčano pričvršćivanje vodiča presjeka 1,5-2,5 mm²
- KS zaštita za djecu od dodira kontakta

SOCKET SCHUKO DOUBLE 2P+E 16A 250V~

- 2P+E schuko double
- 16A 250V~, type VE16
- in accordance with IEC 60884-1, CEE7
- screw contacts 1.5-2.5 mm²
- KS build-in child protection – shuttered live contacts



- VE46PWKS
- VE46IWKS
- VE46ESKS
- VE46NBKS

UTIČNICA FRANCUSKA DVOSTRUKA 2P + E 16A 250V~

- 2P + E francuska dvostruka
- 16A 250V~, tip VE46
- sukladno normama IEC 60884-1, CEE7; NF C 61-314, CSN 33 2318; PN-E 93201
- vijčano pričvršćivanje vodiča presjeka 1,5-2,5 mm²
- KS zaštita za djecu od dodira kontakta

SOCKET FRENCH DOUBLE 2P+E 16A 250V~

- 2P+E French double
- 16A 250V~, type VE46
- in accordance with IEC 60884-1, CEE7; NF C 61-314, CSN 33 2318; PN-E 93201
- screw contacts 1.5-2.5 mm²
- KS build-in child protection – shuttered live contacts



- VE30PW
- VE30IW
- VE30ES
- VE30NB

UTIČNICA 2P 16A 250V ~

- 2P bez voda za uzemljenje
- 16A 250V~
- sukladno normama EN 60884-1, CEE7 (lista standarda I)
- vijčano pričvršćivanje vodiča presjeka 1,5-2,5mm²

SOCKET 2P 16A 250V~

- 2P without earthing contact
- 16A 250V~
- in accordance with EN 60884-1, CEE7 (standard sheet I)
- screw contacts 1.5-2.5mm²

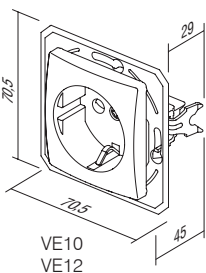

VE10
VE12

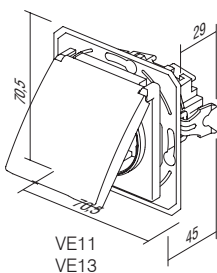

VE11
VE13
VE41
VE43

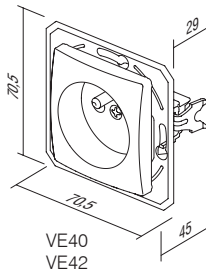

VE40
VE42

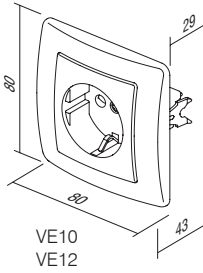

VE10
VE12

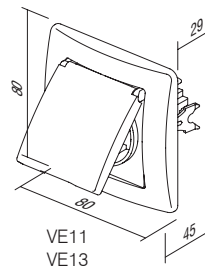

VE11
VE13
VE41
VE43

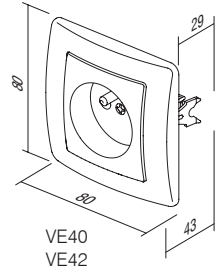

VE40
VE42

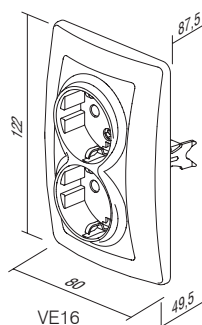

VE16

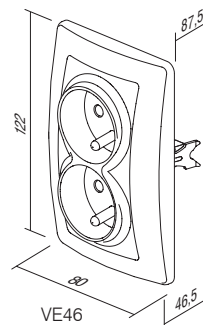

VE46

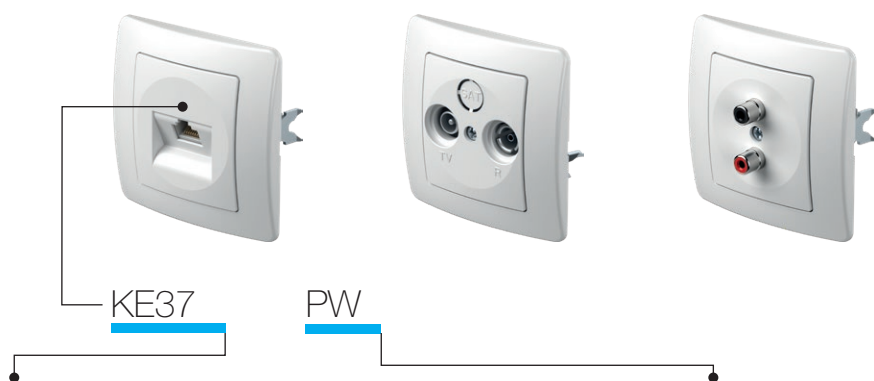

tip type	naziv description	tehnički podaci technical data	boja colour
KE11	UTIČNICA TV-R ZAVRŠNA SOCKET TV-R END-LINE	1dB	<input type="checkbox"/> PW bijela sjajna polar white
KE12	UTIČNICA TV-R PROLAZNA SOCKET TV-R THROUGHPASS	10dB	<input type="checkbox"/> IW bež sjajna ivory white
KE16	UTIČNICA SAT-TV-R ZAVRŠNA SOCKET SAT-TV-R END-LINE	3dB	<input type="checkbox"/> ES srebrna mat elox silver
⋮	⋮	⋮	<input type="checkbox"/> CO bijeli duroplast white thermoset
⋮	⋮	⋮	<input type="checkbox"/> NB crna sjajna night black

UTIČNICA TV-R ZAVRŠNA 1dB



KE11

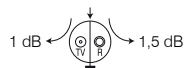

- TV-R završna
- propušta frekvenciju u rasponu 5÷862MHz
- prigušenje: R-1,5dB, TV-1dB
- sukladno normi EN 50083-1
- vijčano pričvršćivanje

SOCKET TV-R END-LINE 1dB

- TV-R end-line
- frequency range 5÷862MHz
- reduction: R-1,5dB, TV-1dB
- in accordance with EN 50083-1
- screw contacts

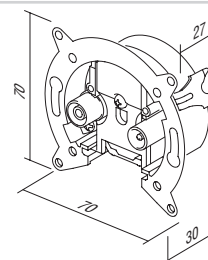

UTIČNICA TV-R PROLAZNA 10dB



KE12

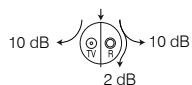

- TV-R prolazna
- propušta frekvenciju u rasponu 5÷862MHz
- prigušenje: R-10dB, TV-10dB, prolaz-2dB
- sukladno normi EN 50083-1
- vijčano pričvršćivanje

SOCKET TV-R TROUGHPASS 10dB

- TV-R troughpass
- frequency range 5÷862MHz
- reduction: R-10dB, TV-10dB, trough-2dB
- in accordance with EN 50083-1
- screw contacts

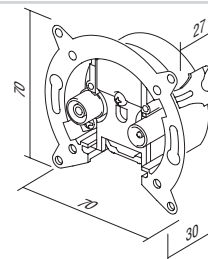

UTIČNICA SAT-TV-R ZAVRŠNA 3dB



KE16

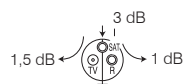

- SAT-TV-R završna
- propušta frekvenciju u rasponu 5÷2400MHz
- prigušenje: R-1dB, TV-1,5dB, SAT-3dB
- za ugradnju u okruglu kutiju Ø60 s nožicama ili vijcima
- sukladno normi EN 50083-1
- vijčano pričvršćivanje

SOCKET SAT-TV-R END-LINE 3dB

- SAT-TV-R end-line
- frequency range 5÷2400MHz
- reduction: R-1dB, TV-1,5dB, SAT-3dB
- for mounting in round box Ø60 with claws or screws
- in accordance with EN 50083-1
- screw contacts

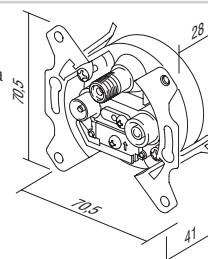

UTIČNICA TEL KS RJ11 6/4



KE36

- KS keystone standard pričvršćivanja
- RJ11 6/4
- sukladno normi IEC 60603-7

SOCKET TEL KS RJ11 6/4

- KS keystone fixing standard
- RJ11 6/4
- in accordance with IEC 60603-7

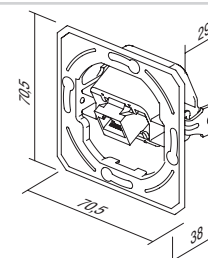

UTIČNICA CAT5e KS RJ45 8/8



KE37

- KS keystone standard pričvršćivanja
- CAT5e, RJ45 8/8
- sukladno normi IEC 60603-7

SOCKET CAT5e KS RJ45 8/8

- KS keystone fixing standard
- CAT5e, RJ45 8/8
- in accordance with IEC 60603-7

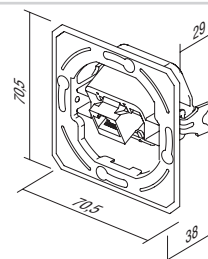

UTIČNICA CAT6s KS RJ45 8/8 SLIM



KE40

- KS keystone standard pričvršćivanja
- CAT6s, RJ45 8/8
- sukladno normi IEC 60603-7

SOCKET CAT6s KS RJ45 8/8 SLIM

- KS keystone fixing standard
- CAT6s, RJ45 8/8
- in accordance with IEC 60603-7

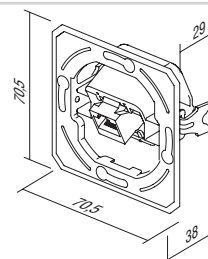

UTIČNICA TEL KS DVOSTRUKA 2x RJ11 6/4



KE38

- KS keystone standard pričvršćivanja
- 2x RJ11 6/4
- sukladno normi IEC 60603-7

SOCKET TEL KS DOUBLE 2x RJ11 6/4

- KS keystone fixing standard
- 2x RJ11 6/4
- in accordance with IEC 60603-7

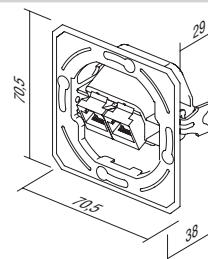

UTIČNICA CAT5e KS DVOSTRUKA 2x RJ45 8/8



KE39

- KS keystone standard pričvršćivanja
- 2x CAT5e, RJ45 8/8
- sukladno normi IEC 60603-7

SOCKET CAT5e KS DOUBLE 2x RJ45 8/8

- KS keystone fixing standard
- 2x CAT5e, RJ45 8/8
- in accordance with IEC 60603-7

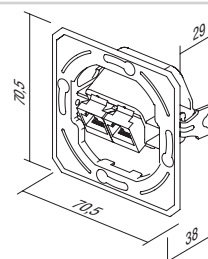

UTIČNICA CAT6s KS DVOSTRUKA 2x RJ45 8/8 SLIM



KE41

- KS keystone standard pričvršćivanja
- 2x CAT6s, RJ45 8/8
- sukladno normi IEC 60603-7

SOCKET CAT6s KS DOUBLE 2x RJ45 8/8 SLIM

- KS keystone fixing standard
- 2x CAT6s, RJ45 8/8
- in accordance with IEC 60603-7

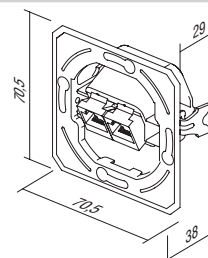

ADAPTER KS JEDNOSTRUKI



KE45

- KS keystone standard priključivanja - jednostruki
- AMP, Avaya, Brandrex, FMT, Mfico, Tyco, ...
- nije ugrađen komunikacijski modul

ADAPTER KS SINGLE

- KS keystone fixing standard - single
- AMP, Avaya, Brandrex, FMT, Mfico, Tyco, ...
- communication module not included

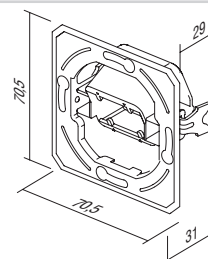



KE46

ADAPTER KS DVOSTRUKI

- KS keystone standard priključivanja - dvostruki
- AMP, Tyco, ...
- nije ugrađen komunikacijski modul

ADAPTER KS DOUBLE

- KS keystone fixing standard - double
- AMP, Tyco, ...
- communication module not included

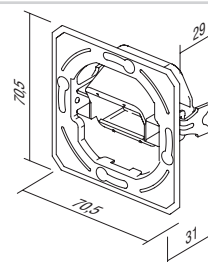

KE47

ADAPTER PD DVOSTRUKI

- standard pričvršćivanja PD Panduit Mini-COM – dvostruki
- nije ugrađen komunikacijski modul

ADAPTER PD DOUBLE

- PD Panduit Mini-COM fixing standard - double
- communication module not included

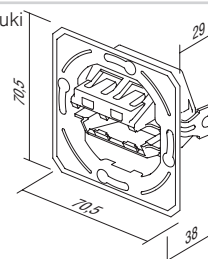

UTIČNICA TV OSNOVNA 0dB



- KE10PW
- KE10IW
- KE10ES
- KE10CO
- KE10NB

- TV osnovna
- prigušenje 0dB
- stražnji konektor – F standard

SOCKET TV BASIC 0dB

- TV basic
- reduction 0dB
- back connector – F standard



UTIČNICA TV-R ZAVRŠNA 1dB



- KE11PW
- KE11IW
- KE11ES
- KE11CO
- KE11NB

- TV-R završna
- propušta frekvenciju u rasponu 5-862 MHz
- prigušenje: R-1,5dB, TV-1dB
- sukladno normi EN 50083-1
- vijčano pričvršćivanje

SOCKET TV-R END-LINE 1dB

- TV-R end-line
- frequency range 5-862 MHz
- reduction: R-1.5dB, TV-1dB
- in accordance with EN 50083-1
- screw contact



UTIČNICA TV-R PROLAZNA 10dB



- KE12PW
- KE12IW
- KE12ES
- KE12CO
- KE12NB

- TV-R prolazna
- propušta frekvenciju u rasponu 5-862 MHz
- prigušenje: R-10dB, TV-10dB, prolaz-2dB
- sukladno normi EN 50083-1
- vijčano pričvršćivanje

SOCKET TV-R TROUGHPASS 10dB

- TV-R troughpass
- frequency range 5-862 MHz
- reduction: R-10dB, TV-10dB, trough-2dB
- in accordance with EN 50083-1
- screw contacts



UTIČNICA SAT-TV-R ZAVRŠNA 3dB



- KE16PW
- KE16IW
- KE16ES
- KE16CO
- KE16NB

- SAT-TV-R završna
- propušta frekvenciju u rasponu 5-2400 MHz
- prigušenje: R-1dB, TV-1,5dB, SAT-3dB
- sukladno normi EN 50083-1
- vijčano pričvršćivanje

SOCKET SAT-TV-R END-LINE 3dB

- SAT-TV-R end-line
- frequency range 5-2400 MHz
- reduction: R-1dB, TV-1.5dB, SAT-3dB
- in accordance with EN 50083-1
- screw contacts



UTIČNICA AUDIO 2xRCA



- KE22PW
- KE22IW
- KE22ES
- KE22CO
- KE22NB

- audio 2xRCA
- pričvršćivanje vodiča lemljenjem

SOCKET AUDIO 2xRCA

- audio 2xRCA
- soldering connection of cable



UTIČNICA AUDIO ZVUČNICI



- KE23PW
- KE23IW
- KE23ES
- KE23CO
- KE23NB

- audio 2x Ø4 mm
- pričvršćivanje vodiča za zvučnike umetanjem ili banana utikačem Ø4 mm
- lemljenje spojeva kabela na stražnjoj strani

SOCKET AUDIO LOUDSPEAKERS

- audio 2x Ø4mm
- to accommodate speaker wire, banana plug Ø4mm or spades
- soldering connection of cable at the back side



UTIČNICA TEL KS RJ11 6/4

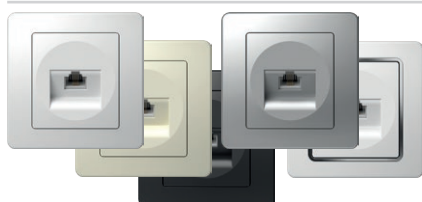

- KE36PW
- KE36IW
- KE36ES
- KE36CO
- KE36NB

- KS keystone standard pričvršćivanja
- RJ11 6/4
- sukladno normi IEC 60603-7

SOCKET TEL KS RJ11 6/4

- KS keystone fixing standard
- RJ11 6/4
- in accordance with IEC 60603-7





- KE37PW
- KE37IW
- KE37ES
- KE37CO
- KE37NB

UTIČNICA CAT5e KS RJ45 8/8

- KS keystone standard pričvršćivanja
- CAT5e, RJ45 8/8
- sukladno normi IEC 60603-7

SOCKET CAT5e KS RJ45 8/8

- KS keystone fixing standard
- CAT5e, RJ45 8/8
- in accordance with IEC 60603-7



- KE40PW
- KE40IW
- KE40ES
- KE40CO
- KE40NB

UTIČNICA CAT6s KS RJ45 8/8 SLIM

- KS keystone standard pričvršćivanja
- CAT6s, RJ45 8/8
- sukladno normi IEC 60603-7

SOCKET CAT6s KS RJ45 8/8 SLIM

- KS keystone fixing standard
- CAT6s, RJ45 8/8
- in accordance with IEC 60603-7

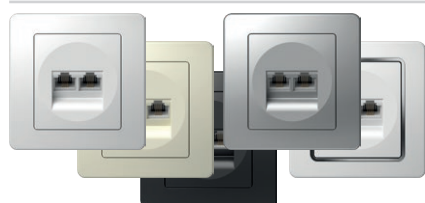

- KE38PW
- KE38IW
- KE38ES
- KE38CO
- KE38NB

UTIČNICA TEL KS DVOSTRUKA 2x RJ11 6/4

- KS keystone standard pričvršćivanja
- 2x RJ11, 6/4
- sukladno normi IEC 60603-7

SOCKET TEL KS DOUBLE 2x RJ11 6/4

- KS keystone fixing standard
- 2x RJ11, 6/4
- in accordance with IEC 60603-7



- KE39PW
- KE39IW
- KE39ES
- KE39CO
- KE39NB

UTIČNICA CAT5e KS DVOSTRUKA 2x RJ45 8/8

- KS keystone standard pričvršćivanja
- 2x CAT5e, RJ45 8/8
- sukladno normi IEC 60603-7

SOCKET CAT5e KS DOUBLE 2x RJ45 8/8

- KS keystone fixing standard
- 2x CAT5e, RJ45 8/8
- in accordance with IEC 60603-7



- KE41PW
- KE41IW
- KE41ES
- KE41CO
- KE41NB

UTIČNICA CAT6s KS DVOSTRUKA 2x RJ45 8/8 SLIM

- KS keystone standard pričvršćivanja
- 2x CAT6s, RJ45 8/8
- sukladno normi IEC 60603-7

SOCKET CAT6s KS DOUBLE 2x RJ45 8/8 SLIM

- KS keystone fixing standard
- 2x CAT6s, RJ45 8/8
- in accordance with IEC 60603-7

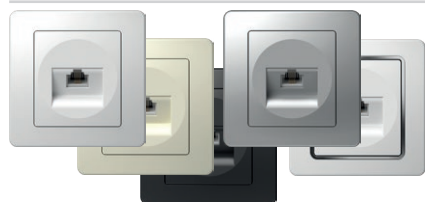

- KE35PW
- KE35IW
- KE35ES
- KE35CO
- KE35NB

UTIČNICA TEL LT RJ11 6/4

- TEL LT vijak
- vijčano pričvršćivanje
- RJ11 6/4
- sukladno normi IEC 60603-7

SOCKET TEL LT RJ11 6/4

- TEL LT screw
- screw contacts
- RJ11 6/4
- in accordance with IEC 60603-7

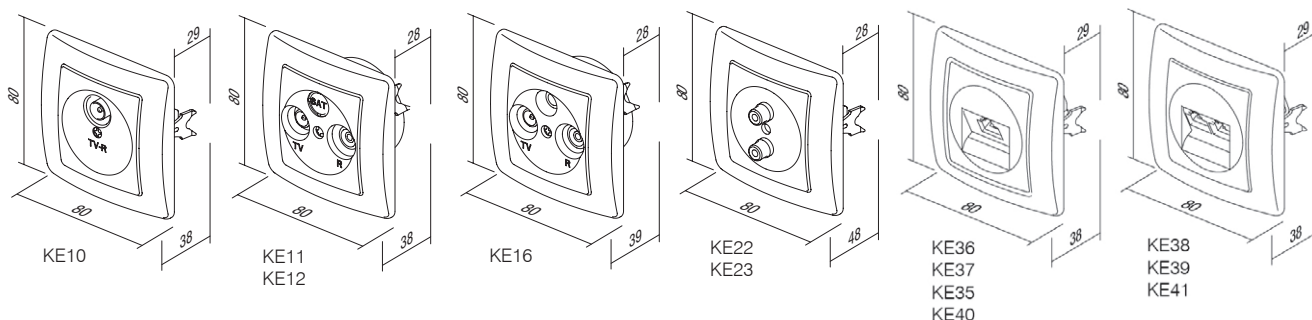



PE20

PW

tip type	naziv description	tehnički podaci technical data	boja colour
PE10	POKLOPAC TV-R COVER TV-R	2P/3P	<input type="checkbox"/> PW bijela sjajna polar white
PE20	POKLOPAC KS JEDNOSTRUKI COVER KS SINGLE		<input type="checkbox"/> IW bež sjajna ivory white
PE21	POKLOPAC KS DVOSTRUKI COVER KS DOUBLE		<input type="checkbox"/> ES srebrna mat elox silver
...	<input type="checkbox"/> CO bijeli duroplast white thermoset
			<input type="checkbox"/> NB crna sjajna night black

POKLOPAC TV-R 2P/3P

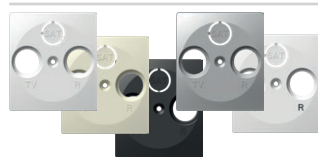

- PE10PW
- PE10IW
- PE10ES
- PE10CO
- PE10NB

- poklopac TV-R, 2P ili 3P s vijkom

COVER TV-R 2P/3P

- TV-R cover, 2P or 3P with screw



POKLOPAC KS JEDNOSTRUKI

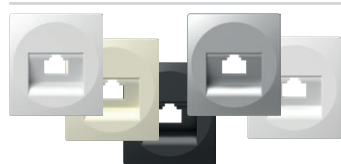

- PE20PW
- PE20IW
- PE20ES
- PE20CO
- PE20NB

- KS poklopac jednostrukim

COVER KS SINGLE

- KS cover single



POKLOPAC KS DVOSTRUKI

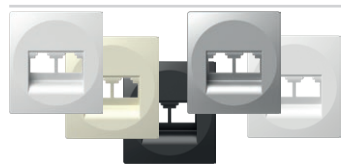

- PE21PW
- PE21IW
- PE21ES
- PE21NB

- KS poklopac dvostruki

COVER KS DOUBLE

- KS cover double



POKLOPAC TAE/TDO



- PE30PW
- PE30IW
- PE30ES
- PE30NB

- TAE ili TDO poklopac s vijkom

COVER TAE/TDO

- TAE or TDO cover with screw



POKLOPAC IR SKLOPKA



- PE32PW
- PE32IW
- PE32ES
- PE32NB

- poklopac IR sklopka

COVER IR SWITCH

- cover IR switch

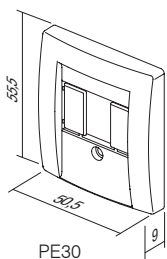

PE30

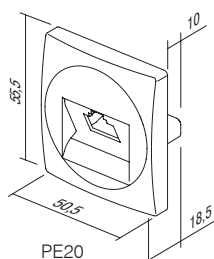

PE20

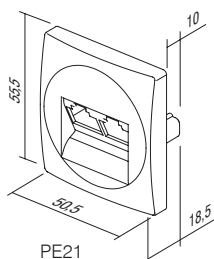

PE21

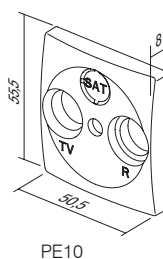

PE10

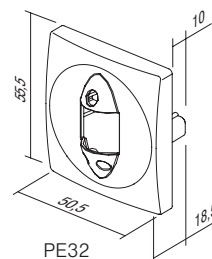

PE32

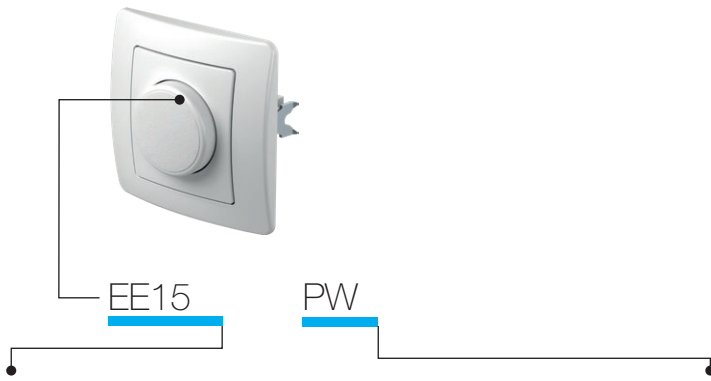

tip type	naziv description	tehnički podaci technical data	boja colour
EE15	REGULATOR OSVJETLJENJA ROTACIJSKI IZMJENIČNI <i>DIMMER ROTATIVE 2WAY</i>	RL 400W	<input type="checkbox"/> PW bijela sjajna <i>polar white</i>
EE16	REGULATOR OSVJETLJENJA ROTACIJSKI IZMJENIČNI <i>DIMMER ROTATIVE 2WAY</i>	RLC 400W	<input type="checkbox"/> IW bež sjajna <i>ivory white</i>
EE19	REGULATOR OSVJETLJENJA ROTACIJSKI IZMJENIČNI <i>DIMMER ROTATIVE 2WAY</i>	LED 100W	<input type="checkbox"/> ES srebrna mat <i>elox silver</i>
⋮	⋮	⋮	<input type="checkbox"/> CO bijeli duroplast <i>white thermoset</i>
⋮	⋮	⋮	<input type="checkbox"/> NB crna sjajna <i>night black</i>

REGULATOR OSVJETLJENJA ROTACIJSKI IZMJENIČNI RL 400W



EE15

- rotacijski s izmjeničnom sklopkom
- opterećenje RL, 40W – 400W
- moguća je kombinacija s izmjeničnom sklopkom
- povezivanje više regulatora osvjetljenja nije dopušteno
- sukladno normama EN 60669-1 i EN 60669-2-1
- bezvijčani kontakti 1,5mm²
- napajanje 230V ~ 50Hz
- unutarnji promjer tipke Ø6 mm
- priložen zamjenjivi osigurač

DIMMER ROTATIVE 2WAY RL 400W

- rotation control with 2-way switch
- load RL, 40W - 400W
- 2-way switch combination is possible
- more dimmers combination is not allowed
- in accordance with EN 60669-1 and EN 60669-2-1
- plug-in contacts 1.5mm²
- supply 230V ~ 50Hz
- button inner diameter Ø6mm
- replaceable fuse included

REGULATOR OSVJETLJENJA ROTACIJSKI IZMJENIČNI RLC 400W



EE16

- rotacijski s izmjeničnom sklopkom
- opterećenje RLC, 20W – 400W
- moguća je kombinacija s izmjeničnom sklopkom
- povezivanje više regulatora osvjetljenja nije dopušteno
- sukladno normama EN 60669-1 i EN 60669-2-1
- bezvijčani kontakti 1,5mm²
- unutarnji promjer tipke Ø6 mm
- napajanje 230V ~ 50Hz
- elektronski osigurač

DIMMER ROTATIVE 2WAY RLC 400W

- rotation control with 2-way switch
- load RLC, 20W - 400W
- 2-way switch combination is possible
- more dimmers combination is not allowed
- in accordance with EN 60669-1 and EN 60669-2-1
- plug-in contacts 1.5mm²
- supply 230V ~ 50Hz
- button inner diameter Ø6mm
- electronic fuse



EE19

REGULATOR OSVJETLJENJA ROTACIJSKI IZMJENIČNI LED 100W

- rotacijski s izmjeničnom sklopkom
- opterećenje: LED, 0-100W (maks. 10 LED)
GLS, 10-250W
- moguća je kombinacija s izmjeničnom sklopkom
- povezivanje više regulatora osvjetljenja nije dopušteno
- sukladno normama EN 60669-1 i EN 60669-2-1
- bezvijčani kontakti 1,5mm²
- napajanje 230V ~ 50Hz
- priložen zamjenjivi osigurač
- unutarnji promjer tipke Ø6 mm

DIMMER ROTATIVE 2WAY LED 100W

- rotation control with 2-way switch
- load: LED, 0-100W (max. 10 LEDs)
GLS, 10-250W
- 2-way switch combination is possible
- more dimmers combination is not allowed
- in accordance with EN 60669-1 and EN 60669-2-1
- plug-in contacts 1.5mm²
- supply 230V ~ 50Hz
- replaceable fuse included
- button inner diameter Ø6mm

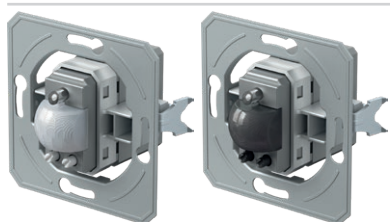

- EE32A1
- EE32A2

IR SKLOPKA 5A 230V~

- IR infracrvena sklopka
- napajanje: 230V ~ ± 10% 50Hz
- relej: 5A / 250V ~ izlaz za ograničeni strujni tok s velikim otporom za prolaz kroz ništicu („zero crossing“)
- zaštitna razina: IP40
- presjek žica na kontaktnom terminalu: 0,75 - 2,5 mm²
- kut prepoznavanja: do 110° pri 20 °C
- raspon prepoznavanja: približno 8m pri 20 °C
- prilagodljivost trajanja: od približno 5 s do 12 min
- prilagodljivost osvjetljenja: od približno 5 do 200 LUX
- temperatura radnog okruženja: od 0 °C do +40 °C
- nije prikladno za ugradnju u kutije duboke 45 mm
- samo za unutrašnju uporabu

IR SWITCH 5A 230V~

- IR infrared switch
- supply voltage: 230V ~ ±10 % 50Hz
- relay: 5A / 250V ~ output for limited current with high resistance for zero crossing
- protection rating: IP40
- cross-section of wires at the contact terminal: 0.75 - 2.5 mm²
- detection angle: up to 110° at 20°C
- detection area: approx. 8 m at 20°C
- adjustability of duration: from approx. 5 s to 12 min
- adjustability of brightness: from approx. 5 to 200 LUX
- operating temperature: from 0°C to +40°C
- not suitable for installation in 45 mm deep boxes
- only for indoor usage



- EE15PW
- EE15IW
- EE15ES
- EE15CO
- EE15NB

REGULATOR OSVJETLJENJA ROTACIJSKI IZMJENIČNI RL 400W

- rotacijski s izmjeničnom sklopkom
- opterećenje RL, 40W – 400W
- moguća je kombinacija s izmjeničnom sklopkom
- povezivanje više regulatora osvjetljenja nije dopušteno
- sukladno normama EN 60669-1 i EN 60669-2-1
- bezvijčani kontakti 1,5mm²
- napajanje 230V ~ 50Hz
- priložen zamjenjivi osigurač

DIMMER ROTATIVE 2WAY RL 400W

- rotation control with 2-way switch
- load RL, 40W - 400W
- 2-way switch combination is possible
- more dimmers combination is not allowed
- in accordance with EN 60669-1 and EN 60669-2-1
- plug-in contacts 1.5mm²
- supply 230V ~ 50Hz
- replaceable fuse included



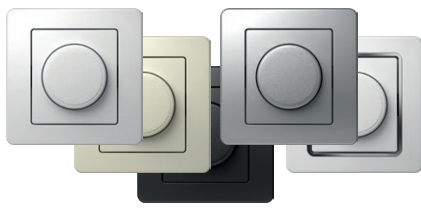

- EE16PW
- EE16IW
- EE16ES
- EE16CO
- EE16NB

REGULATOR OSVJETLJENJA ROTACIJSKI IZMJENIČNI RLC 400W

- rotacijski s izmjeničnom sklopkom
- opterećenje RLC, 20W – 400W
- moguća je kombinacija s izmjeničnom sklopkom
- povezivanje više regulatora osvjetljenja nije dopušteno
- sukladno normama EN 60669-1 i EN 60669-2-1
- bezvijačni kontakti 1,5mm²
- napajanje 230V ~ 50Hz
- elektronski osigurač



DIMMER ROTATIVE 2WAY RLC 400W

- rotation control with 2-way switch
- load RLC, 20W - 400W
- 2-way switch combination is possible
- more dimmers combination is not allowed
- in accordance with EN 60669-1 and EN 60669-2-1
- plug-in contacts 1.5mm²
- supply 230V ~ 50Hz
- electronic fuse

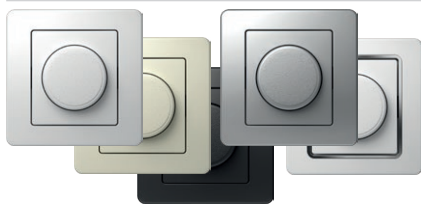

- EE19PW
- EE19IW
- EE19ES
- EE19CO
- EE19NB

REGULATOR OSVJETLJENJA ROTACIJSKI IZMJENIČNI LED 100W

- rotacijski s izmjeničnom sklopkom
- opterećenje: LED, 0-100W (maks. 10 LED)
GLS, 10-250W
- moguća je kombinacija s izmjeničnom sklopkom
- povezivanje više regulatora osvjetljenja nije dopušteno
- sukladno normama EN 60669-1 i EN 60669-2-1
- bezvijačni kontakti 1,5mm²
- napajanje 230V ~ 50Hz
- priložen zamjenjivi osigurač



DIMMER ROTATIVE 2WAY LED 100W

- rotation control with 2-way switch
- load: LED, 0-100W (max. 10 LEDs)
GLS, 10-250W
- 2-way switch combination is possible
- more dimmers combination is not allowed
- in accordance with EN 60669-1 and EN 60669-2-1
- plug-in contacts 1.5mm²
- supply 230V ~ 50Hz
- replaceable fuse included



- EE32PW
- EE32IW
- EE32ES
- EE32CO
- EE32NB

IR SKLOPKA 5A 230V~

- IR infracrvena sklopka
- napajanje: 230V ~ ± 10% 50Hz
- relej: 5A / 250V~ izlaz za ograničeni strujni tok s velikim otporom za prolaz kroz ništicu („zero crossing“)
- zaštitna razina: IP40
- presjek žica na kontaktnom terminalu: 0,75 - 2,5 mm²
- kut prepoznavanja: do 110° pri 20 °C
- raspon prepoznavanja: približno 8m pri 20 °C
- prilagodljivost trajanja: od približno 5 s do 12 min
- prilagodljivost osvjetljenja: od približno 5 do 200 LUX
- temperatura radnog okruženja: od 0 °C do +40 °C
- nije prikladno za ugradnju u kutije duboke 45 mm
- samo za unutrašnju uporabu



IR SWITCH 5A 230V~

- IR infrared switch
- supply voltage: 230V ~ ±10 % 50Hz
- relay: 5A / 250V~ output for limited current with high resistance for zero crossing
- protection rating: IP40
- cross-section of wires at the contact terminal: 0.75 - 2.5 mm²
- detection angle: up to 110° at 20°C
- detection area: approx. 8 m at 20°C
- adjustability of duration: from approx. 5 s to 12 min
- adjustability of brightness: from approx. 5 to 200 LUX
- operating temperature: from 0°C to +40°C
- not suitable for installation in 45 mm deep boxes
- only for indoor usage

EE15, EE16, EE19

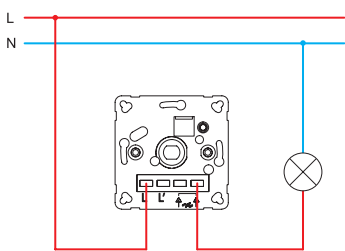

EE15, EE16, EE19

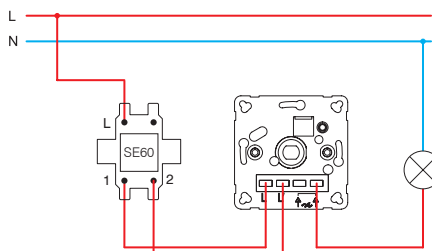

EE15, EE16, EE19

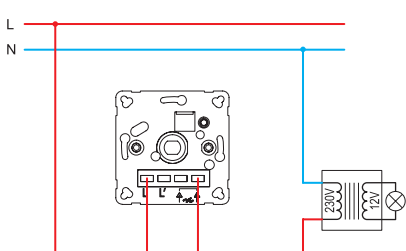

EE15, EE16, EE19

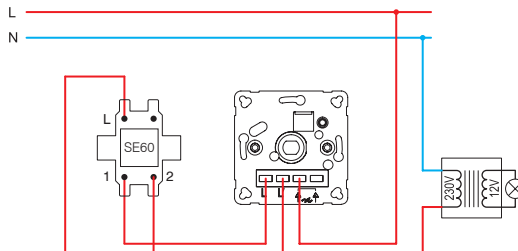

EE16, EE19

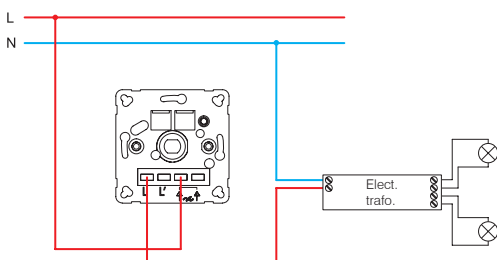

EE16, EE19

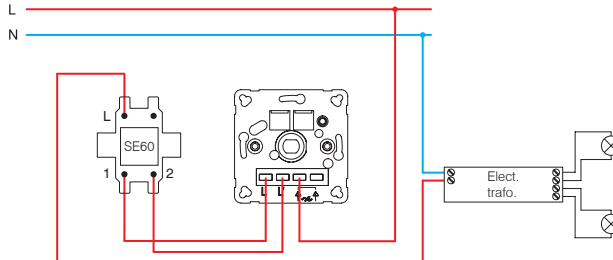

ekonomik

EE15 (40÷400W)

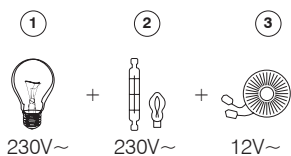

- 1 - žarulja sa žarnom niti / incandescent lamp
- 2 - halogena žarulja / halogen lamp

EE16 (20÷400W)

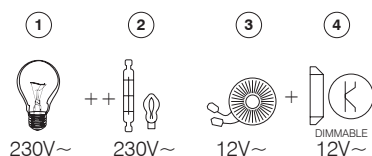

- 3 - klasični transformator / classical transformer
- 4 - elektronički transformator s regulatorom osvijetljenja / dimmable electronic transformer

EE19 (GLS 10÷250W ; LED 0÷100W)

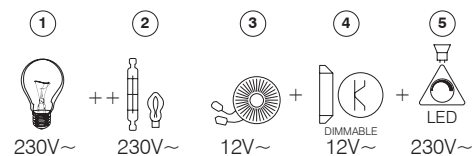

- 5 - LED tinjalica s regulacijom osvijetljenja / dimmable LED lamp

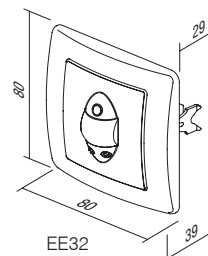
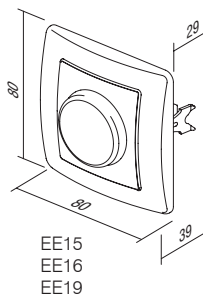
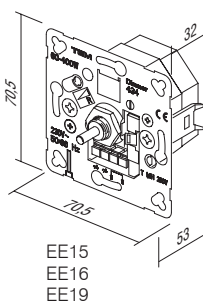

P O K L O P C I P E

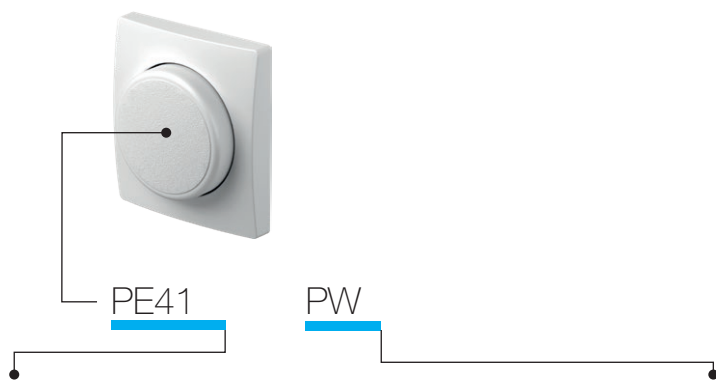

tip type	naziv description	boja colour
PE41	POKLOPAC REGULATORA OSVJETLJENJA COVER DIMMER	<input type="checkbox"/> PW bijela sjajna <i>polar white</i> <input type="checkbox"/> IW bež sjajna <i>ivory white</i> <input type="checkbox"/> ES srebrna mat <i>elox silver</i> <input type="checkbox"/> CO bijeli duroplast <i>white thermoset</i> <input type="checkbox"/> NB crna sjajna <i>night black</i>



- PE41PW
- PE41IW
- PE41ES
- PE41CO
- PE41NB

POKLOPAC REGULATORA OSVJETLJENJA Ø6

- poklopac regulatora osvjetljenja Ø6 mm
- za EE15, EE16, EE19

COVER DIMMER Ø6

- cover dimmer Ø6mm
- for EE15, EE16, EE19

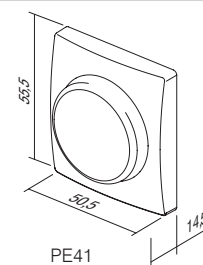

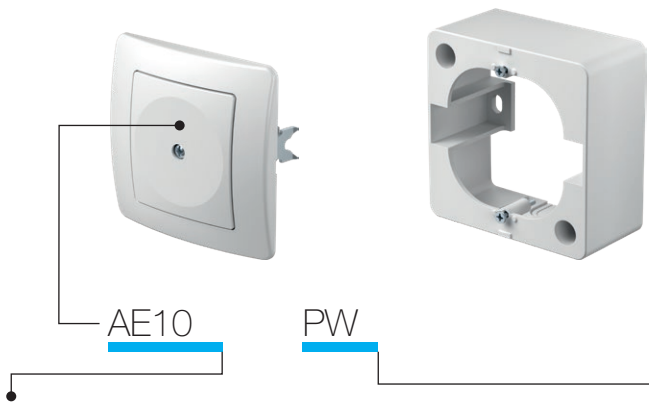

tip type	naziv description	boja colour
AE10	SLIJEPI ELEMENT BLANK	<input type="checkbox"/> PW bijela sjajna polar white
AE20	PRIKLJUČNA KUTIJA 3P + N + E 5X4mm ² CONNECTION BOX 3P+N+E 5X4mm ²	<input type="checkbox"/> IW bež sjajna ivory white
AE30	NADŽBUKNA KUTIJA SURFACE MOUNT BOX	<input type="checkbox"/> ES srebrna mat elox silver
·	·	<input type="checkbox"/> CO bijeli duroplast white thermoset
·	·	<input type="checkbox"/> NB crna sjajna night black

SLIJEPI ELEMENT



- AE10PW
- AE10IW
- AE10ES
- AE10CO
- AE10NB

- za pokrivanje praznog prostora
BLANK
- for filling up empty spaces



PRIKLJUČNA KUTIJA 5-POLNA 3P + N + E 5x4mm²



- AE20PW
- AE20IW

- priključna kutija 3P+N+E
- 16A 400V
- sukladno normi VDE 0606-1:2000
- vijčano pričvršćivanje vodiča presjeka 1,5-4mm²
CONNECTION BOX 5POLE 3P+N+E 5x4mm²
- 3P+N+E connection box
- 16A 400V
- in accordance with VDE 0606-1:2000
- screw contacts 1.5-4mm²



NADŽBUKNA KUTIJA 1

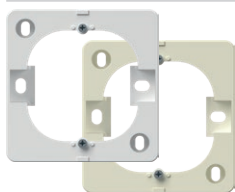

- AE30PW
- AE30IW

- nadžbukna kutija
SURFACE MOUNT BOX 1
- surface mounting box



NADŽBUKNA KUTIJA ZA DVOSTRUKU UTIČNICU EKONOMIK

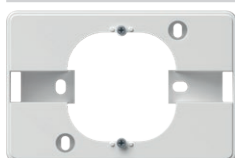

- AE31PW

- nadžbukna kutija
SURFACE MOUNT BOX FOR
EKONOMIK DOUBLE SOCKET
- surface mounting box





- AE50PW
- AE50TS

ZIDNI ŠTITNIK

- štiti površinu oko utičnice ili sklopke

WALL PROTECTION

- protects surface around socket or switch

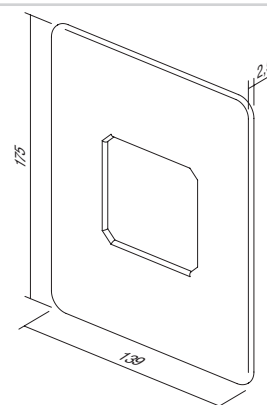

- AE51PW
- AE51IW

ZAŠTITA ZA DJECU KS

- KS dodatna zaštita za djecu od dodira kontakta

CHILD PROTECTION KS

- KS additional child protection insert - shuttered live contacts

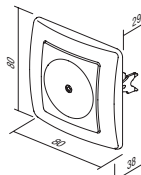
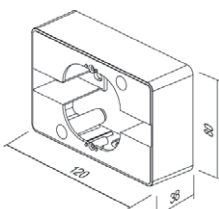
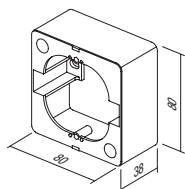
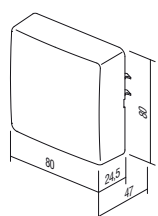
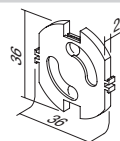

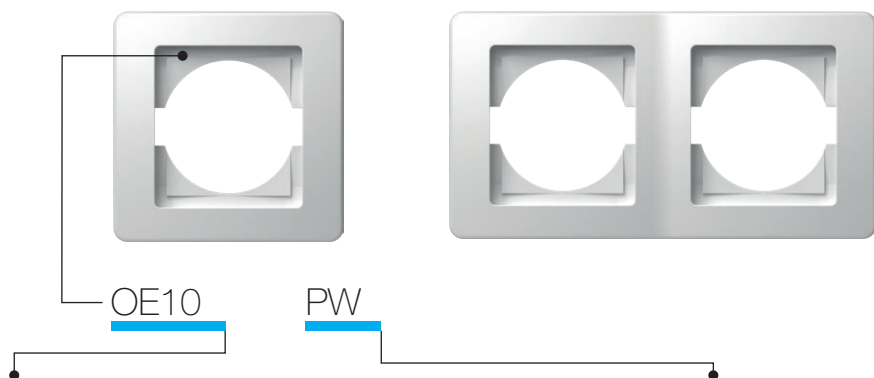

tip type	naziv description	boja colour
OE10	OKVIR EKONOMIK 1 SURROUND EKONOMIK 1	<input type="checkbox"/> PW bijela sjajna polar white
OE20	OKVIR EKONOMIK 2 VODORAVNI SURROUND EKONOMIK 2 HORIZONTAL	<input type="checkbox"/> IW bež sjajna ivory white
OE30	OKVIR EKONOMIK 3 VODORAVNI SURROUND EKONOMIK 3 HORIZONTAL	<input type="checkbox"/> ES srebrna mat elox silver
·	·	<input type="checkbox"/> CO bijeli duroplast white thermoset
·	·	<input type="checkbox"/> NB crna sjajna night black



- OE10PW
- OE10IW
- OE10ES
- OE10CO
- OE10NB

OKVIR EKONOMIK 1

- dekorativni pojedinačni okvir
- sukladno normi EN 60669-1
SURROUND EKONOMIK 1
- decorative surround 1-gang
- in accordance with EN 60669-1

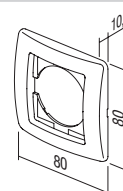

- OE20PW
- OE20IW
- OE20ES
- OE20CO
- OE20NB

OKVIR EKONOMIK 2 VODORAVNI

- dekorativni dvostruki okvir vodoravni
- sukladno normi EN 60669-1
SURROUND EKONOMIK 2 HORIZONTAL
- decorative surround 2-gang horizontal
- in accordance with EN 60669-1

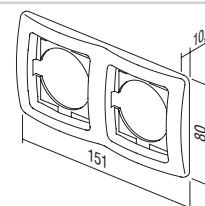

- OE21PW
- OE21IW
- OE21ES
- OE21CO
- OE21NB

OKVIR EKONOMIK 2 OKOMITI

- dekorativni dvostruki okvir okomiti
- sukladno normi EN 60669-1
SURROUND EKONOMIK 2 VERTICAL
- decorative surround 2-gang vertical
- in accordance with EN 60669-1

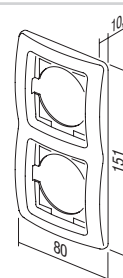

- OE30PW
- OE30IW
- OE30ES
- OE30CO
- OE30NB

OKVIR EKONOMIK 3 VODORAVNI

- dekorativni trostruki okvir vodoravni
- sukladno normi EN 60669-1
SURROUND EKONOMIK 3 HORIZONTAL
- decorative surround 3-gang horizontal
- in accordance with EN 60669-1

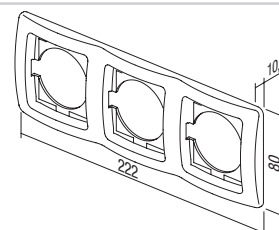



- OE31PW
- OE31IW
- OE31ES
- OE31CO
- OE31NB

OKVIR EKONOMIK 3 OKOMITI

- dekorativni trostruki okvir okomiti
- sukladno normi EN 60669-1

SURROUND EKONOMIK 3 VERTICAL

- decorative surround 3-gang vertical
- in accordance with EN 60669-1

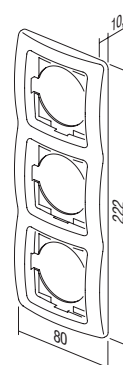

- OE40PW
- OE40IW
- OE40ES
- OE40NB

OKVIR EKONOMIK 4 VODORAVNI

- dekorativni četverostruki okvir vodoravni
- sukladno normi EN 60669-1

SURROUND EKONOMIK 4 HORIZONTAL

- decorative surround 4-gang horizontal
- in accordance with EN 60669-1

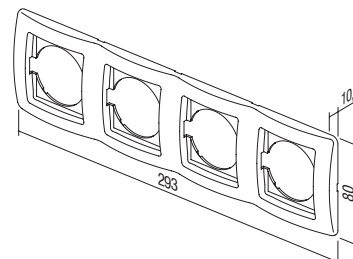

- OE41PW
- OE41IW
- OE41ES
- OE41NB

OKVIR EKONOMIK 4 OKOMITI

- dekorativni četverostruki okvir okomiti
- sukladno normi EN 60669-1

SURROUND EKONOMIK 4 VERTICAL

- decorative surround 4-gang vertical
- in accordance with EN 60669-1

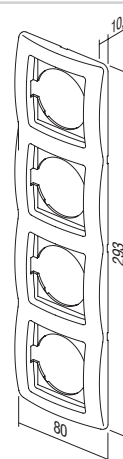

- OE50PW
- OE50IW
- OE50ES
- OE50NB

OKVIR EKONOMIK 5 VODORAVNI

- dekorativni peterostruki horizontalni okvir
- sukladno normi EN 60669-1

SURROUND EKONOMIK 5 HORIZONTAL

- decorative surround 5-gang horizontal
- in accordance with EN 60669-1

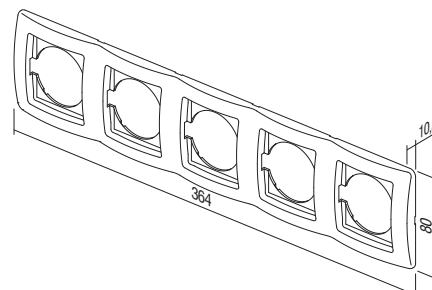

DEKORATIVNI UMETCI U BOJI /
COLOR DECORATIVE FRAMES



OE90GR	ZELENI / GREEN	OE90YL	ŽUTI / YELLOW	OE90MB	MET. PLAVI / MET. BLUE
OE90BL	PLAVI / BLUE	OE90WH	BIJELI / WHITE	OE90BZ	BRONČANI / BRONZE
OE90VO	LJUBIČASTI / VIOLET	OE90GY	SIVI / GREY	OE90CR	SREBRNI / SILVER
OE90PI	RUŽIČASTI / PINK	OE90BK	CRNI / BLACK	OE90GO	ZLATNI / GOLD
OE90RD	CRVENI / RED				



TEM



KATALOG / CATALOGUE

fontana

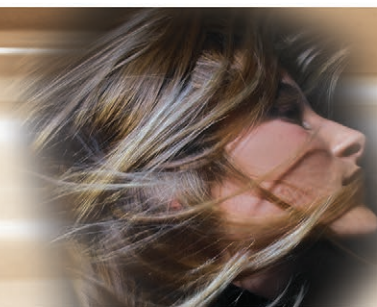

SKLOPKE SF
SWITCHES SF



218

UTIČNICE VF
SOCKETS VF



220

SETOVI CF
SETS CF



221

PRIBOR AF
ACCESSORIES AF



223

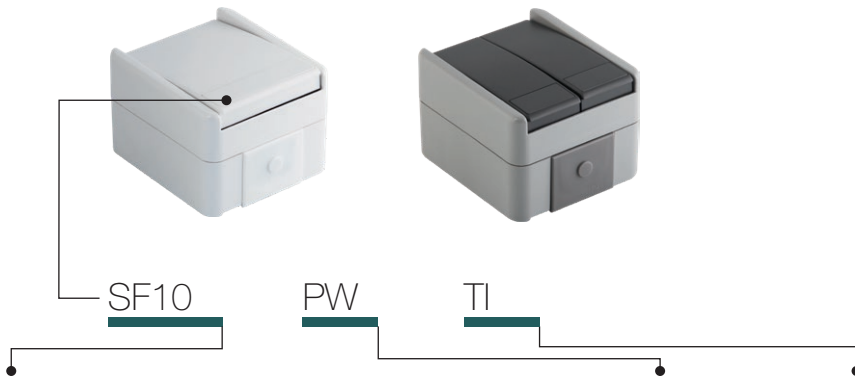

tip type	naziv description	tehnički podaci technical data	boja colour	opsijski podaci 1 optional data 1
SF10	SKLOPKA JEDNOPOLNA SWITCH 1WAY	IP44 10AX 250V~	<input type="checkbox"/> PW <i>bijela mat (RAL 9016)</i> <input type="checkbox"/> TI <i>neonska tinjalica + indikator neon lamp+indication</i>	
SF11	TIPKALO JEDNOPOLNO PUSH BUTTON 1WAY	IP44 10A 250V~	<input type="checkbox"/> GY <i>mat siva grey-mat</i>	
SF20	SKLOPKA DVOPOLNA SWITCH 2POLE	IP44 10AX 250V~		
:	:	:		
:	:	:		

SKLOPKA JEDNOPOLNA IP44 10AX 250V ~



- SF10PW
 SF10GY

- 10AX 250V~, tip SF10
- sukladno normi EN 60669-1
- bezvijčani kontakti 1,5-2,5mm²
SWITCH 1WAY IP44 10AX 250V~
- 10AX 250V~, type SF10
- in accordance with EN 60669-1
- plug-in contacts 1.5-2.5mm²



SKLOPKA JEDNOPOLNA IP44 10AX 250V ~ __ TI



- SF10PWTI
 SF10GYTI

- TI indikator + neonska tinjalica
- 10AX 250V~, tip SF10
- sukladno normi EN 60669-1
- bezvijčani kontakti 1,5-2,5mm²
SWITCH 1WAY IP44 10AX 250V~ __ TI
- TI indikator+neon lamp
- 10AX 250V~, type SF10
- in accordance with EN 60669-1
- plug-in contacts 1.5-2.5mm²



TIPKALO JEDNOPOLNO IP44 10A 250V~ __ TI



- SF11PWTI
 SF11GYTI

- TI indikator + neonska tinjalica
- 10A 250V~, tip SF11
- sukladno normi EN 60669-1
- bezvijčani kontakti 1,5-2,5mm²
PUSH BUTTON 1WAY IP44 10A 250V~ __ TI
- TI indikator+neon lamp
- 10A 250V~, type SF11
- in accordance with EN 60669-1
- plug-in contacts 1.5-2.5mm²



SKLOPKA DVOPOLNA IP44 10AX 250V ~



- SF20PW
 SF20GY

- 10AX 250V~, tip SF20
- sukladno normi EN 60669-1
- bezvijčani kontakti 1,5-2,5mm²
SWITCH 2POLE IP44 10AX 250V~
- 10AX 250V~, type SF20
- in accordance with EN 60669-1
- plug-in contacts 1.5-2.5mm²



SKLOPKA SERIJSKA JEDNOPOLNA IP44 10AX 250V ~



- SF50PW
- SF50GY

- 10AX 250V~, tip SF50
- sukladno normi EN 60669-1
- bezvijčani kontakti 1,5-2,5mm²

SWITCH 2GANG-1WAY IP44 10AX 250V~

- 10AX 250V~, type SF50
- in accordance with EN 60669-1
- plug-in contacts 1.5-2.5mm²



TIPKALO SERIJSKO JEDNOPOLNO IP44 10A 250V ~



- SF51PW
- SF51GY

- 10A 250V~, tip SF51
- sukladno normi EN 60669-1
- bezvijčani kontakti 1,5-2,5mm²

PUSH BUTTON 2GANG-1WAY IP44 10A 250V~

- 10A 250V~, type SF51
- in accordance with EN 60669-1
- plug-in contacts 1.5-2.5mm²



SKLOPKA IZMJENIČNA IP44 10AX 250V ~



- SF60PW
- SF60GY

- 10AX 250V~, tip SF60
- sukladno normi EN 60669-1
- bezvijčani kontakti 1,5-2,5mm²

SWITCH 2WAY IP44 10AX 250V~

- 10AX 250V~, type SF60
- in accordance with EN 60669-1
- plug-in contacts 1.5-2.5mm²



SKLOPKA IZMJENIČNA IP44 10AX 250V ~ __ TI



- SF60PWTI
- SF60GYTI

- TI indikator + neonska tinjalica
- 10AX 250V~, tip SF60
- sukladno normi EN 60669-1
- bezvijčani kontakti 1,5-2,5mm²

SWITCH 2WAY IP44 10AX 250V~ __ TI

- TI indicator+neon lamp
- 10AX 250V~, type SF60
- in accordance with EN 60669-1
- plug-in contacts 1.5-2.5mm²



SKLOPKA IZMJENIČNA DVOSTRUKA IP44 10AX 250V ~



- SF63PW
- SF63GY

- 10AX 250V~, tip SF63
- sukladno normi EN 60669-1
- bezvijčani kontakti 1,5-2,5mm²

SWITCH 2WAY DOUBLE IP44 10AX 250V~

- 10AX 250V~, type SF63
- in accordance with EN 60669-1
- plug-in contacts 1.5-2.5mm²



SKLOPKA KRIŽNA IP44 10AX 250V ~



- SF70PW
- SF70GY

- 10AX 250V~, tip SF70
- sukladno normi EN 60669-1
- bezvijčani kontakti 1,5-2,5mm²

SWITCH INTERMEDIATE IP44 10AX 250V~

- 10AX 250V~, type SF70
- in accordance with EN 60669-1
- plug-in contacts 1.5-2.5mm²

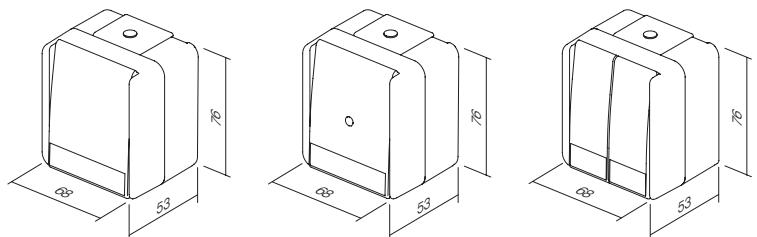

U T I Č N I C E V F S O C K E T S



VF10

PW

tip type	naziv description	tehnički podaci technical data	boja colour
VF10	ŠUKO UTIČNICA+POKLOPAC SOCKET SCHUKO+COVER	IP44 2P+E 16A 250V~	<input type="checkbox"/> PW bijela mat (RAL 9016) white-mat <input type="checkbox"/> GY mat siva grey-mat

UTIČNICA ŠUKO + POKLOPAC IP44 2P+E 16A 250V ~



- VF10PW
- VF10GY

- vijčano pričvršćivanje vodiča presjeka 1,5-2,5 mm²
- 2P+E šuko+poklopac
- 16A 250V~, tip VF10
- sukladno normama EN 60884-1, CEE7

SOCKET SCHUKO+COVER IP44 2P+E 16A 250V~

- screw contacts 1.5-2.5mm²
- 2P+E schuko+cover
- 16A 250V~, type VF10
- in accordance with EN 60884-1, CEE7



UTIČNICA ŠUKO + POKLOPAC IP44 2P+E 16A 250V ~ BV



- VF12PW
- VF12GY

- BV bezvijčani kontakti 1,5-2,5mm²
- 2P+E šuko+poklopac
- 16A 250V~, tip VF12
- sukladno normama EN 60884-1, CEE7

SOCKET SCHUKO+COVER IP44 2P+E 16A 250V~ BV

- BV plug-in contacts 1.5-2.5mm²
- 2P+E schuko+cover
- 16A 250V~, type VF12
- in accordance with EN 60884-1, CEE7

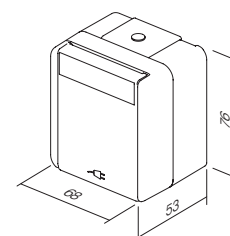

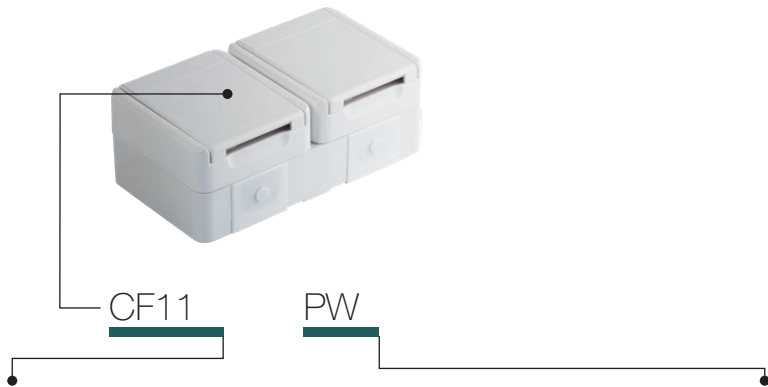

tip type	naziv description	tehnički podaci technical data	boja colour
CF10	SET ŠUKO UTIČNICA DVOSTRUKIH VODORAVNE SOCKET SET SCHUKO DOUBLE HORIZ	2x 2P+E 16A 250V~ IP44	<input type="checkbox"/> PW bijela mat (RAL 9016) white-mat
CF11	SET ŠUKO UTIČNICA DVOSTRUKIH OKOMITE SOCKET SET SCHUKO DOUBLE VERT	2x 2P+E 16A 250V~ IP44	<input checked="" type="checkbox"/> GY mat siva grey-mat
CF12	ŠUKO UTIČNICA + SKLOPKA IZMJENIČNI VODORAVNI SOCKET SCH+SWITCH 2WAY HORIZ	16A + 10A 250V~ IP44	
⋮	⋮	⋮	
⋮	⋮	⋮	



- CF10PW
 CF10GY

SET ŠUKO UTIČNICA, DVOSTRUKI, VODORAVNI IP44 2x 2P+E 16A 250V ~

- vijčano pričvršćivanje vodiča presjeka 1,5-2,5 mm²
- 2x 2P+E šuko + poklopac vodoravni
- 16A 250V~, tip CF10
- sukladno normama EN 60884-1, CEE7

SOCKET SET SCHUKO DOUBLE HORIZONTAL IP44 2x 2P+E 16A 250V~

- screw contacts 1.5-2.5mm²
- 2x 2P+E schuko+cover horizontal
- 16A 250V~, type CF10
- in accordance with EN 60884-1, CEE7



- CF11PW
 CF11GY

SET ŠUKO UTIČNICA DVOSTRUKI, OKOMITI IP44 2x 2P+E 16A 250V ~

- vijčano pričvršćivanje vodiča presjeka 1,5-2,5 mm²
- 2x 2P+E šuko + poklopac, okomiti set
- 16A 250V~, tip CF11
- sukladno normama EN 60884-1, CEE7

SOCKET SET SCHUKO DOUBLE VERTICAL IP44 2x 2P+E 16A 250V~

- screw contacts 1.5-2.5mm²
- 2x 2P+E schuko+cover vertical
- 16A 250V~, type CF11
- in accordance with EN 60884-1, CEE7



- CF12PW
 CF12GY

SET ŠUKO UTIČNICA + SKLOPKA IZMJENIČNA, VODORAVNI IP44 16A + 10AX 250V ~

- vijčano (priključnica), bezvijčano (sklopka) pričvršćivanje vodiča presjeka 1,5-2,5mm²
- 2P+E šuko+poklopac + sklopka izmjenična vodoravna
- 16A + 10AX 250V~, tip CF12
- sukladno normama EN 60884-1, CEE7, EN 60669-1

SOCKET SCH+SWITCH SET 2WAY HORIZONTAL IP44 16A + 10AX 250V~

- screw (socket), plug-in (switch) contacts 1.5-2.5mm²
- 2P+E schuko+cover + switch 2-way horizontal
- 16A + 10AX 250V~, type CF12
- in accordance with EN 60884-1, CEE7, EN 60669-1



SET ŠUKO UTIČNICA + SKLOPKA IZMJENIČNA, OKOMITI, IP44 16A + 10AX 250V~



- CF13PW
- CF13GY

- vijčano (prikjučnica), bezvijčano (sklopka)
- pričvršćivanje vodiča presjeka 1,5-2,5mm²
- 2P+E šuko+poklopac + sklopka izmjenična okomita
- 16A + 10AX 250V ~, tip CF13
- sukladno normama EN 60884-1, CEE7, EN 60669-1

SOCKET SCH+SWITCH 2WAY SET VERTICAL IP44 16A + 10AX 250V~

- screw (socket), plug-in (switch)
- contacts 1.5-2.5mm²
- 2P+E schuko+cover + switch 2-way vertical
- 16A + 10AX 250V~, type CF13
- in accordance with EN 60884-1, CEE7, EN 60669-1



SET ŠUKO UTIČNICA DVOSTRUKI, VODORAVNI, IP44 2X 2P+E 16A 250V ~ BV



- CF14PW
- CF14GY

- BV bezvijčani kontakti 1,5-2,5mm²
- 2x 2P+E šuko + poklopac vodoravni
- 16A 250V~, tip CF14
- sukladno normama EN 60884-1, CEE7

SOCKET SET SCHUKO DOUBLE HORIZONTAL IP44 2x 2P+E 16A 250V~ BV

- BV plug-in contacts 1.5-2.5mm²
- 2x 2P+E schuko+cover horizontal
- 16A 250V~, type CF14
- in accordance with EN 60884-1, CEE7



SET ŠUKO UTIČNICA DVOSTRUKI, OKOMITI, IP44 2X 2P+E 16A 250V ~ BV



- CF15PW
- CF15GY

- BV bezvijčani kontakti 1,5-2,5mm²
- 2x 2P+E šuko + poklopac, okomiti set
- 16A 250V~, tip CF15
- sukladno normama EN 60884-1, CEE7

SOCKET SET SCHUKO DOUBLE VERTICAL IP44 2x 2P+E 16A 250V~ BV

- BV plug-in contacts 1.5-2.5mm²
- 2x 2P+E schuko+cover vertical
- 16A 250V~, type CF15
- in accordance with EN 60884-1, CEE7



SET UTIČNICA + SKLOPKA IZMJENIČNA, VODORAVNI, IP44 16A + 10AX 250V ~ BV



- CF16PW
- CF16GY

- BV bezvijčani kontakti 1,5-2,5mm²
- 2P+E šuko+poklopac + sklopka izmjenična vodoravna
- 16A + 10AX 250V ~, tip CF16
- sukladno normama EN 60884-1, CEE7, EN 60669-1

SOCKET+SWITCH SET SCH+2WAY HORIZONTAL IP44 16A + 10AX 250V~ BV

- BV plug-in contacts 1.5-2.5mm²
- 2P+E schuko+cover + switch 2-way horizontal
- 16A + 10AX 250V~, type CF16
- in accordance with EN 60884-1, CEE7, EN 60669-1



SET UTIČNICA + SKLOPKA IZMJENIČNA, OKOMITI, IP44 16A + 10AX 250V ~ BV



- CF17PW
- CF17GY

- BV bezvijčani kontakti 1,5-2,5mm²
- 2P+E šuko+poklopac + sklopka izmjenična okomita
- 16A + 10AX 250V ~, tip CF17
- sukladno normama EN 60884-1, CEE7, EN 60669-1

SOCKET SCH+SWITCH 2WAY SET VERTICAL IP44 16A + 10AX 250V~ BV

- BV plug-in contacts 1.5-2.5mm²
- 2P+E schuko+cover + switch 2-way vertical
- 16A + 10AX 250V~, type CF17
- in accordance with EN 60884-1, CEE7, EN 60669-1



P R I B O R A F
A C C E S S O R I E S

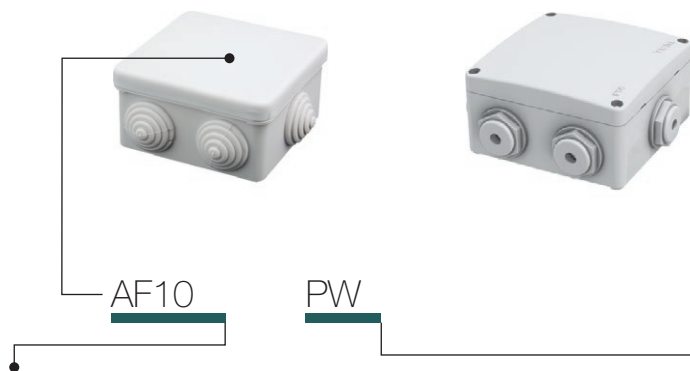

tip type	naziv description	tehnički podaci technical data	boja colour
AF10	RAZDJELNI ORMARIĆ DISTRIBUTION BOX	IP44 RN01	<input type="checkbox"/> PW bijela mat (RAL 9016) white-mat
AF20	RAZDJELNI ORMARIĆ DISTRIBUTION BOX	IP55 NDO1	<input type="checkbox"/> GY mat siva grey-mat

RAZDJELNI ORMARIĆ IP44 RN01



- AF10PW
- AF10GY

- nadžbukni razdjelni ormarić IP44
- 16A 400V ~
- sukladno normi IEC/EN 60670-1, IEC/EN 60670-22

DISTRIBUTION BOX IP44 RN01

- surface mounting distribution box IP44
- 16A 400V ~
- in accordance with IEC/EN 60670-1, IEC/EN 60670-22

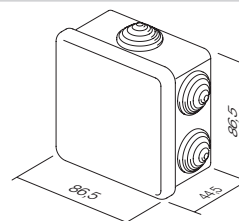

RAZDJELNI ORMARIĆ IP55 ND01



- AF20PW
- AF20GY

- nadžbukna priključna kutija IP55
- brtve uključene
- sukladno normi IEC/EN 60670-1, IEC/EN 60670-22

DISTRIBUTION BOX IP55 ND01

- surface mounting connection box IP55
- glands included
- in accordance with IEC/EN 60670-1, IEC/EN 60670-22

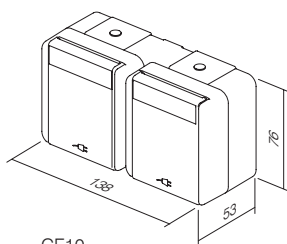
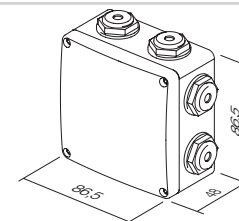

CF10
CF14

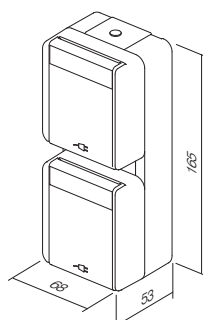

CF11
CF15

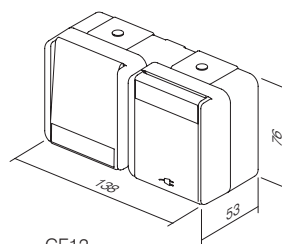

CF12
CF16

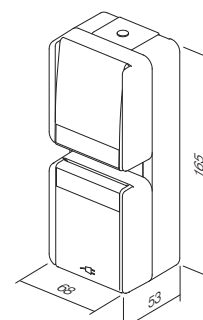

CF13
CF17

MODUL

šifra	opis proizvoda	stranica	šifra	opis proizvoda	stranica
SKLOPKE SM			KOMUNIKACIJE KM		
SM10	SKLOPKA JEDNOPOLNA 16AX 250V~ 1M	68	KM10--	UTIČNICA TV OSNOVNA 0dB 1M	82
SM11	TIPKALO JEDNOPOLNO 16A 250V~ 1M	68	KM20--	UTIČNICA TV OSNOVNA 0dB 2M	82
SM12	SKLOPKA JEDNOPOLNA 20A 250V~ 1M	68	KM11--	UTIČNICA TV ZAVRŠNA 1dB 1M	82
SM20	SKLOPKA DVOPOLNA 16AX 250V~ 1M	68	KM12--	UTIČNICA TV PROLAZNA 10dB 1M	82
SM40	SKLOPKA ŽALUZIJSKA 1-0-2 16AX 250V~ 1M	69	KM15--	UTIČNICA SAT OSNOVNA 0dB 1M	83
SM41	TIPKALO ŽALUZIJSKO 1-0-2 16A 250V~ 1M	69	KM24--	UTIČNICA SAT OSNOVNA 0dB 2M	83
SM60	SKLOPKA IZMJENIČNA 16AX 250V~ 1M	69	KM16--	UTIČNICA SAT ZAVRŠNA 1dB 1M	83
SM61	TIPKALO IZMJENIČNO 16A 250V~ 1M	69	KM19--	UTIČNICA R OSNOVNA 0dB 1M	83
SM70	SKLOPKA KRIŽNA 16AX 250V~ 1M	69	KM29--	UTIČNICA R OSNOVNA 0dB 2M	83
SM10--	SKLOPKA JEDNOPOLNA 16AX 250V~ 1M	70	KM25--	UTIČNICA SAT-TV ZAVRŠNA 1dB 2M	83
SM10--IN	SKLOPKA JEDNOPOLNA 16AX 250V~ 1M IN	70	KM22--	UTIČNICA AUDIO 2xRCA 1M	84
SM11--	TIPKALO JEDNOPOLNO 16A 250V~ 1M	70	KM23--	UTIČNICA AUDIO ZVUČNICI 1M	84
SM11--IN01	TIPKALO JEDNOPOLNO 16A 250V~ 1M IN 01	70	KM26--	UTIČNICA AUDIO ZVUČNICI 2M	84
SM11--IN02	TIPKALO JEDNOPOLNO 16A 250V~ 1M IN 02	71	KM30--	UTIČNICA TEL LT RJ11 6/4 1M	85
SM20--NT03	SKLOPKA DVOPOLNA 16AX 250V~ 1M NT 03	71	KM31--	UTIČNICA TEL BT SEC 6/6 1M	85
SM20--IN	SKLOPKA DVOPOLNA 16AX 250V~ 1M IN	71	KM36--	UTIČNICA TEL KS RJ11 6/4 1M	85
SM40--NT10	SKLOPKA ŽALUZIJSKA 1-0-2 16AX 250V~ 1M NT 10	71	KM37--	UTIČNICA CAT5e KS RJ45 8/8 1M	85
SM41--NT10	TIPKALO ŽALUZIJSKO 1-0-2 16A 250V~ 1M NT 10	71	KM35--	ADAPTER KS 1M	85
SM60--	SKLOPKA IZMJENIČNA 16AX 250V~ 1M	71	KM38--	ADAPTER KS SA ZAŠTITOM OD PRAŠINE 1M	85
SM61--	TIPKALO IZMJENIČNO 16A 250V~ 1M	72	KM39--	UTIČNICA CAT6 SCH KS RJ45 8/8 1M	86
SM62--CD	TIPKALO IZMJENIČNO S UZICOM 16A 250V~ 1M CD	72	KM50--	ADAPTER KS UNIVERZALNI 1M	86
SM70--	SKLOPKA KRIŽNA 16AX 250V~ 1M	72	KM40--	ADAPTER PD 1M	86
TIPKE TM			KM43--	ADAPTER PD SA ZAŠTITOM OD PRAŠINE 1M	86
TM11--	TIPKA 1M	73	KM46--	ADAPTER R&M 1M	86
TM11--IN	TIPKA 1M INDIKATOR	73	KM52--	ADAPTER R&M CAT6A 1M	86
TM12--	TIPKA 2M	73	KM47--	ADAPTER R&M SA ZAŠTITOM OD PRAŠINE 1M	87
TM12--IN	TIPKA 2M INDIKATOR	73	KM53--	ADAPTER R&M CAT6A SA ZAŠTITOM OD PRAŠINE 1M	87
TM13--IL	TIPKA 2M S NATPISNOM PLOČICOM	74	KM45--	ADAPTER LK 1M	88
TM15--	TIPKA 1M DVOPOLNA	74	KA26	ADAPTER NEXSANS/SCHRACK 2M	88
TM21--	SLJEPI ELEMENT 1M	74	KM48--	ADAPTER AT&T SYSTIMAX SA ZAŠTITOM OD PRAŠINE 1M	88
TM22--	SLJEPI ELEMENT 2M	74	KM51--	UTIČNICA USB TIP A 1M	88
TM31--	UVODNICA 1M	74	DODACI KOMUNIKACIJA KA		
OSVETLJENJE IA			KA10	KONEKTOR KS CAT3 RJ11 6/4	89
IA10--	NEONSKA TINJALICA 230V~ 0,34W	76	KA11	KONEKTOR KS CAT5e RJ45 8/8	89
IA20--	LED TINJALICA 230V~ AC/DC 0,40W	76	KA12	KONEKTOR KS CAT5eS RJ45 8/8	89
IA21--	LED TINJALICA 24V AC/DC 0,20W	76	KA15	KONEKTOR KS CAT6 SCHRACK RJ45 8/8	89
IA22--	LED TINJALICA 12V AC/DC 0,10W	76	KA16	KONEKTOR KS CAT6S SCHRACK RJ45 8/8	89
IA50	RC SKLOP 250V	76	KA17	KONEKTOR KS CAT6a SCHRACK RJ45 8/8	89
UTIČNICE VM			KA18	KONEKTOR TANKI KS CAT6S SCHRACK RJ45 8/8	90
VM10--	UTIČNICA ŠUKO+KS 2P+E 16A 250V~ 2M	78	KA27	KONEKTOR KS HDMI	90
VM11--	UTIČNICA ŠUKO+KS+POKLOPAC 2P+E 16A 250V~ 2M	78	KA28	KABEL KS HDMI	90
VM20--	UTIČNICA EURO+KS 2P 10A 250V~ 1M	79	ELEKTRONIKA EM		
VM40--	UTIČNICA FRANCUSKA+KS 2P+E 16A 250V~ 2M	79	EM10--	REGULATOR OSVETLJENJA ROTACIJSKI R 300W 1M	91
VM41--	UTIČNICA FRANCUSKA+KS+POKLOPAC 2P+E 16A 250V~ 2M	79	EM12--	REGULATOR OSVETLJENJA ROTACIJSKI IZMJENIČNI RL 300W 1M	91
VM30--	UTIČNICA TALIJANSKA P17/11+KS 2P+E 16A 250V~ 1M	79	EM13--	REGULATOR OSVETLJENJA ROTACIJSKI IZMJENIČNI LED 60W 1M	92
VM31--	UTIČNICA ŠUKO TALIJANSKA P17/11+KS 2P+E 16A 250V~ 2M	79	EM14--	REGULATOR OSVETLJENJA ROTACIJSKI IZMJENIČNI LED 180W 1M	92
VM32--	UTIČNICA ŠUKO TALIJANSKA P30+KS 2P+E 16A 250V~ 2M	80	EM15--	REGULATOR OSVETLJENJA ROTACIJSKI R 250W 1M	92
VM33--	UTIČNICA TALIJANSKA P11+KS 2P+E 10A 250V~ 1M	80	EM23	UGRADBENI ZATAMNIVAČ R (250 W), (RC, RL 200VA)	93
VM21--	UTIČNICA EURO/AMERIČKA+KS 2P 16A 250V~ 1M	80	EM18	UGRADBENI ZATAMNIVAČ LED 250 W	93
VM51--	UTIČNICA BRITANSKA BS546+KS 2P+E 15A 250V~ 2M	80	EM19	UGRADBENI ZATAMNIVAČ DC LED 96 W	93
VM52--	UTIČNICA BRITANSKA BS 1363+KS 2P+E 13A 250V~ 2M	80	EM25--	SKLOPKA/REGULATOR OSVETLJENJA UNIVERZALNI RLC 0-300W 2M	95
VM80	PRENAPONSKA ZAŠTITA MPE MINI 275V/50Hz	80	EM26--	UPRAVLJAČKA JEDINICA - TIPKALO 2M	97
			EM27	FREKVENCIJSKI FILTAR	97
			EM25PPOL20	SET SKLOPKA/REGULATOR OSVETLJENJA UNIVERZALNI RLC 0-300W 2M PP OL20	97
			EM31--	IR SKLOPKA 5A 250V~ 1M	98
			EM32--	IR SKLOPKA 5A 250V~ 2M	98
			EM37--	TERMOSTAT OSNOVNI 6A 230V~2M	100
			NM39	NOSAČ S VIJCIMAZA TERMOSTATE FANTINI COSMI 3M	101
			EM40--	ŠTEDNA KARTIČNA SKLOPKA 3A 250V~ 3M	101
			EM47	KARTICA ISO	101
			EM44--	ŠTEDNA KARTIČNA SKLOPKA RF HF 13,56MHz 3M	102
			EM49	ŠTEDNA KONTROLNA JEDINICA 2x16A 250V~	102
			EM45	RAZDCAJAČ SPL-1	102
			EM60--	UTIČNICA ZA BRIJAČI APARAT 230V~/120V~ 3M	103
			EM66--	JEDINICA NAPA JANJA 5V 2,1A 1M	103
			EM65--	USB PUNJAČ 5V 1A 2M	103
			EM67--	JEDINICA NAPA JANJA 5V 2,4A 1M	104
			EM55	LED SVJETILJKA ZA SLUČAJ NUŽDE 250V~ 0,9W, NiCd 3h 7M	104
			EM57	LED SVJETILJKA ZA SLUČAJ NUŽDE 230V~ 50 Hz 0,5W, NiMH 2h 2M	104
			EM50--	LED SVJETILJKA JEDNOBOJNA 250V~ 0,8W 2M	105
			EM51--	LED SVJETILJKA DVOBOJNA 250V~ 2x0,4W 2M	105
			EM52--	LED SVJETILJKA 3D DVOBOJNA 250V~ 2x0,4W 2M	105
			EM71--	PREKIDAČ NA OTISAK PRSTA BIOPASS 2M	106
			EM80--	SKLOPKA BESKONTAKTNA 10A 240V~	107
			EM81--	SKLOPKA BESKONTAKTNA, UPRAVLJAČKA JEDINICA	107
			EM90--	ZVONO 8VA 230V~ 1M	108
			EM91--	ZVONO 8VA 12V 1M	108
			EM92--	ZVONO 8VA 230V~ 1M	108
			EM93--	ZVONO 8VA 12V 1M	108
			EM95--	REGULATOR GLASNOĆE ZA 100V AUDIO LINIJU 35W 2M	109
			EM96--	REGULATOR GLASNOĆE 4-8 Ω 35W 2M	109

K U T I J E —

šifra	opis proizvoda	stranica
SETOVI CM		
CM10--	SET UTIČNICA 2x ŠUKO 2P+E 16A 250V~ 4M	110
CM11--	SET UTIČNICA 3x ŠUKO 2P+E 16A 250V~ 7M	110
CM15	SET SPOJNIH VODOVA 3x1,5mm ² 1M	111
CM16	SET SPOJNIH VODOVA 3x2,5mm ² 2M	111
CM17	SET VIJAKA 3,5x20	111
CM18	SET VIJAKA 3,5x35	111
CM19	SET VIJAKA 3,5x50	111
CM22--	SET ZA SKLOPKE IP44 2M	111
CM23--	SET ZA UTIČNICU IP44 2M	111
CM25--OL	KUPAONSKI SET 3x20AX 250V~ 4M	111
CM25--OS	KUPAONSKI SET 3x20AX 250V~ 4M	111
NM41	NOSAČI ZA KUPAONSKI SET 4M	112
OL41--	OKVIR LINE ZA KUPAONSKI SET	112
OS41--	OKVIR SOFT ZA KUPAONSKI SET	112
ANTIBAKTERIJSKI PROGRAM AW		
TM11AW	TIPKA 1M	115
TM11AWIN	TIPKA 1M INDIKATOR	115
TM12AW	TIPKA 2M	115
TM12AWIN	TIPKA 2M INDIKATOR	115
TM21AW	SLIJEPI ELEMENT 1M	115
TM22AW	SLIJEPI ELEMENT 2M	115
VM10AW	UTIČNICA ŠUKO+KS 2P+E 16A 250V~ 2M	116
VM11AW	UTIČNICA ŠUKO+KS+POKLOPAC 2P+E 16A 250V~ 2M	116
VM20AW	UTIČNICA EURO+KS 2P 10A 250V~ 1M	116
KM11AW	UTIČNICA TV ZAVRŠNA 1dB 1M	116
KM35AW	ADAPTER KS 1M	116
OS20AW	OKVIR SOFT 2M	117
OS24AW	OKVIR SOFT 2x2M	117
OS26AW	OKVIR SOFT 3x2M	117
OS30AW	OKVIR SOFT 3M	117
OS40AW	OKVIR SOFT 4M	117
OS70AW	OKVIR SOFT 7M	117
OKVIRI PURE OP		
OP20--	OKVIR PURE 2M	120
OP24--	OKVIR PURE 2x2M	120
OP26--	OKVIR PURE 3x2M	120
OP28--	OKVIR PURE 4x2M	120
OP30--	OKVIR PURE 3M	121
OP40--	OKVIR PURE 4M	121
OP70--	OKVIR PURE 7M	121
OP13--	OKVIR PURE 1/3M	121
OP23--	OKVIR PURE 2/3M	121
OKVIRI LINE OL		
OL20--	OKVIR LINE 2M	124
OL24--	OKVIR LINE 2x2M	124
OL26--	OKVIR LINE 3x2M	124
OL28--	OKVIR LINE 4x2M	124
OL29--	OKVIR LINE 5x2M	124
OL30--	OKVIR LINE 3M	125
OL40--	OKVIR LINE 4M	125
OL70--	OKVIR LINE 7M	125
OL10--	OKVIR LINE 1/2M	125
OL13--	OKVIR LINE 1/3M	125
OL23--	OKVIR LINE 2/3M	125
OKVIRI SOFT OS		
OS20--	OKVIR SOFT 2M	128
OS24--	OKVIR SOFT 2x2M	128
OS26--	OKVIR SOFT 3x2M	128
OS28--	OKVIR SOFT 4x2M	128
OS30--	OKVIR SOFT 3M	129
OS40--	OKVIR SOFT 4M	129
OS70--	OKVIR SOFT 7M	129
OS72--	OKVIR SOFT 2x7M	129
OS10--	OKVIR SOFT 1/2M	129
OS13--	OKVIR SOFT 1/3M	129
OS23--	OKVIR SOFT 2/3M	129
NOSAČI MM		
NM20	NOSAČ S NOŽICAMA 2M	134
NM21	NOSAČ BEZ VIJAKA 2M	134
NM24	NOSAČ METALNI S NOŽICAMA 2M	134
NM25	NOSAČ METALNI BEZ VIJAKA 2M	134
NM30	NOSAČ S VIJCIMA 3M	135
NM40	NOSAČ S VIJCIMA 4M	135
NM70	NOSAČ S VIJCIMA 7M	135
NM72	NOSAČ S VIJCIMA 2x7M	135
NM10	NOSAČ S NOŽICAMA 1/2M	136
NM11	NOSAČ BEZ VIJAKA 1/2M	136
NM23	NOSAČ S NOŽICAMA 2/3M	136
NM32	NOSAČ S VIJCIMA 2/3M	136

šifra	opis proizvoda	stranica
KUTIJE OKRUGLE		
DE10	KUTIJA OKRUGLA ZA ZID OD OPEKE SM60-01	140
DE11	KUTIJA OKRUGLA ZA ZID OD OPEKE DUBOKA SM60-06	140
DE30	VEZNI ČLAN SM60-03	140
DE31	VEZNI ČLAN SM60-04	140
DE12	KUTIJA OKRUGLA ZA ZID OD OPEKE MD65-46	141
DE13	KUTIJA OKRUGLA ZA ZID OD OPEKE DUBOKA MD65-60	141
DE14	PRODUŽETAK ZA MD65-46	141
DE32	VEZNI ČLAN MD65-71	141
DE33	VEZNI ČLAN MD65-91	141
DE20	POKLOPAC KUTIJE ZAŠTITNI 60	141
DE21	POKLOPAC KUTIJE ZAŠTITNI 65	141
DE22	POKLOPAC KUTIJE DEKORATIVNI SM60	141
HE10	KUTIJA OKRUGLA ZA ŠUPLJE ZIDOVE SM68x40	144
HE11	KUTIJA OKRUGLA ZA ŠUPLJE ZIDOVE SM68x55	144
BE10	KUTIJA OKRUGLA ZA BETON 60-49	144
BE11	KUTIJA OKRUGLA ZA BETON DUBOKA 60-77	144
BE20	NOSAČ KUTIJE ZA BETON	144
BE21	UVODNICA ZA KUTIJO ZA BETON 16	144
PRAVOKUTNE KUTIJE		
DM30	KUTIJA PRAVOKUTNA ZA ZID OD OPEKE PM3	148
DM31	KUTIJA PRAVOKUTNA ZA ZID OD OPEKE PM3-65	148
DM40	KUTIJA PRAVOKUTNA ZA ZID OD OPEKE PM4	148
DM41	KUTIJA PRAVOKUTNA ZA ZID OD OPEKE PM4-65	148
DM70	KUTIJA PRAVOKUTNA ZA ZID OD OPEKE PM7	149
DM71	KUTIJA PRAVOKUTNA ZA ZID OD OPEKE PM7-65	149
DM72	KUTIJA PRAVOKUTNA ZA ZID OD OPEKE PM72-65	149
DM80	VEZNI ČLAN KUTIJE PM	149
DM33	POKLOPAC KUTIJE ZAŠTITNI PM3	150
DM34	POKLOPAC KUTIJE DEKORATIVNI PM3	150
DM43	POKLOPAC KUTIJE ZAŠTITNI PM4	150
DM44	POKLOPAC KUTIJE DEKORATIVNI PM4	150
DM73	POKLOPAC KUTIJE ZAŠTITNI PM7	150
DM74	POKLOPAC KUTIJE DEKORATIVNI PM7	150
DM75	POKLOPAC KUTIJE DEKORATIVNI PM72	151
HM30	KUTIJA PRAVOKUTNA ZA ŠUPLJE ZIDOVE VM3	152
HM40	KUTIJA PRAVOKUTNA ZA ŠUPLJE ZIDOVE VM4	152
HM70	KUTIJA PRAVOKUTNA ZA ŠUPLJE ZIDOVE VM7	152
HM72	KUTIJA PRAVOKUTNA ZA ŠUPLJE ZIDOVE VM72	152
BM30	PRAVOKUTNA KUTIJA ZA BETON BM3	153
BM40	PRAVOKUTNA KUTIJA ZA BETON BM4	153
BM70	PRAVOKUTNA KUTIJA ZA BETON BM7	153
BM80	PRIČVRSNI KOMBI-DRŽAČ BM	153
BM82	VEZNI PROFIL ZA KUTIJE	153
PRIKLJUČNE KUTIJE		
DW10	KUTIJA PRIKLJUČNA OKRUGLA ZA ZID OD OPEKE DSM78	156
HW10	KUTIJA PRIKLJUČNA OKRUGLA ZA ŠUPLJE ZIDOVE SM78x45	156
DE23	POKLOPAC KUTIJE DEKORATIVNI SM78	156
DE24	POKLOPAC KUTIJE ZAŠTITNI 78	156
HW20	KUTIJA PRIKLJUČNA ČETVRTASTA ZA ZID OD OPEKE SM105x105	156
PRIBOR ZA OŽIČENJE		
UW10--	JEDNOREDNE STEZALJKE ZATVORENE PC 2x2,5mm ² 10P	158
UW11--	JEDNOREDNE STEZALJKE ZATVORENE PC 2x4,0mm ² 10P	158
UW12--	JEDNOREDNE STEZALJKE ZATVORENE PC 2x6,0mm ² 10P	158
UW15--	JEDNOREDNE STEZALJKE PA 2x2,5mm ² 12P	158
UW16--	JEDNOREDNE STEZALJKE PA 2x4mm ² 12P	158
UW17--	JEDNOREDNE STEZALJKE PA 2x6mm ² 12P	158
UW29--	DVOREDNE STEZALJKE PP 1,0-4,0mm ² 12P	158
UW30--	DVOREDNE STEZALJKE PP 1,5-6,0mm ² 12P	158
UW31--	DVOREDNE STEZALJKE PP 2,5-10,0mm ² 12P	158
UW32--	DVOREDNE STEZALJKE PP 4,0-16,0mm ² 12P	158
UW25--	DVOREDNE STEZALJKE PA 1,0-4,0mm ² 12P	159
UW26--	DVOREDNE STEZALJKE PA 1,5-6,0mm ² 12P	159
UW27--	DVOREDNE STEZALJKE PA 2,5-10,0mm ² 12P	159
UW28--	DVOREDNE STEZALJKE PA 4,0-16,0mm ² 12P	159
UW40--	BEZVIJČANE REDNE STEZALJKE PA 1,5mm ² 3P	159
UW41--	BEZVIJČANE REDNE STEZALJKE PA 1,5mm ² 5P	159
UW42--	BEZVIJČANE REDNE STEZALJKE PA 1,5mm ² 8P	159
UW45--	BEZVIJČANE REDNE STEZALJKE PA 2,5mm ² 3P	159
UW46--	BEZVIJČANE REDNE STEZALJKE PA 2,5mm ² 4P	159
UW47--	BEZVIJČANE REDNE STEZALJKE PA 2,5mm ² 5P	159
UW50--	BEZVIJČANE REDNE STEZALJKE PA 2,5mm ² 2/1P	159

distribucija

šifra	opis proizvoda	stranica
KUĆIŠTA CUBO IP20 AC		
AC11--	KUTIJA NO CUBO SA STRAŽNJIM POKLOPCEM IP20 1M	162
AC21--	KUTIJA NO CUBO SA STRAŽNJIM POKLOPCEM IP20 2M	162
AC41--	KUTIJA NO CUBO SA STRAŽNJIM POKLOPCEM IP20 4M	162
AC61--	KUTIJA NO CUBO SA STRAŽNJIM POKLOPCEM IP20 6M	162
KUĆIŠTA CUBO IP55 AQ		
AQ20--	KUĆIŠTE NO CUBO IP55 2M	163
AQ22--	KUĆIŠTE NO CUBO IP55 2x2M	163
AQ30--	KUĆIŠTE NO CUBO IP55 3M	163
AQ31--	KUĆIŠTE PO CUBO IP55 3M	163
AQ21--	KUTIJA PO CUBO IP55 2M	164
PARAPETNI KANALI ALUMINIJSKI MA		
RT10	ADAPTER MA 92	165
RT12--	POKLOPAC MA 92 2/3M	165
RT14--	POKLOPAC MA 92 4M	165
RT17--	POKLOPAC MA 92 7M	165
RT20--	OSNOVA KANALA MA 130x65	166
RT21--	OSNOVA KANALA MA 165x65	166
RT25--	POKLOPAC KANALA MA 92	166
RT30	PREGRAĐA MA 43	166
RT31	PREGRAĐA MA 43 AL	166
RT32	PREGRAĐA MA 43 AL DVOSTRUKA	166
RT35--	ZAVRŠNI ELEMENT MA 130x65	167
RT36--	ZAVRŠNI ELEMENT MA 165x65	167
RT38	RAVNI VEZNI ELEMENT MA 65	167
RT40--	UNIVERZALNI KUT MA 130x65	167
RT41--	UNIVERZALNI KUT MA 165x65	167
RT42	ELEMENT ZA UZEMLJENJE MA 2x A6,3	167
RT43--	L-KOMAD ELEMENT MA 130x65	168
RT44--	L-KOMAD ELEMENT MA 165x65	168
RT45--	T-KOMAD MA 130x65	168
RT46--	T-KOMAD MA 165x65	168
RT50--	NOSAČ STUPIČA MA JEDNOSTRUKI 130x65	169
RT51--	NOSAČ STUPIČA MA DVOSTRUKI 130x65	169
RT52--	STUPIČ MA 130x65x500	169
RT53--	STUPIČ MA DVOSTRUKI 130x130x500	169
PODNE KUTIJE MT		
RB30	PODNA KUTIJA MT 7 H=53mm	171
RB40	PODNA KUTIJA MT 7 H=88mm	171
RB31	SPOJNA PRIRUBNICA PODNE KUTIJE MT 7 H=53mm	171
RB41	SPOJNA PRIRUBNICA PODNE KUTIJE MT 7 H=88mm	171
RB33	PODNA KUTIJA MT 14 H=53mm	171
RB43	PODNA KUTIJA MT 14 H=88mm	171
RB34	SPOJNA PRIRUBNICA PODNE KUTIJE MT 14 H=53mm	172
RB44	SPOJNA PRIRUBNICA PODNE KUTIJE MT 14 H=88mm	172
RB36	PODNA KUTIJA MT 21 H=53mm	172
RB46	PODNA KUTIJA MT 21 H=88mm	172
RB37	SPOJNA PRIRUBNICA PODNE KUTIJE MT 21 H=53mm	172
RB47	SPOJNA PRIRUBNICA PODNE KUTIJE MT 21 H=88mm	172
RAZVODNI ORMARI MO		
RB10	ADAPTER ZA DIN-TRAČNICU 35mm 1M	173
RB11	ADAPTER ZA DIN-TRAČNICU 35mm 2M	173
RB20	RAZDJELNI ORMARIČ MO 12+2	174
RB21	RAZDJELNI ORMARIČ MO 24+4	174
RB22	RAZDJELNI ORMARIČ MO 36+6	174
RB23	RAZDJELNI ORMARIČ MO 48+8	174

ekonomik

šifra	opis proizvoda	stranica
PREKIDAČI SE		
SE10	SKLOPKA JEDNOPOLNA 10AX 250V~	188
SE11	TIPKALO JEDNOPOLNO 10A 250V~	188
SE22	SKLOPKA DVOPOLNA 16AX 250V~	188
SE50	SKLOPKA SERIJSKA JEDNOPOLNA 10AX 250V~	188
SE51	TIPKALO SERIJSKO JEDNOPOLNO 10A 250V~	189
SE52	SKLOPKA ŽALUZIJSKA 10AX 250V~	189
SE53	TIPKALO ŽALUZIJSKO 10A 250V~	189
SE60	SKLOPKA IZMJENIČNA 10AX 250V~	189
SE63	SKLOPKA IZMJENIČNA DVOSTRUKA 10AX 250V~	189
SE70	SKLOPKA KRIŽNA 10AX 250V~	189
SE10--	SKLOPKA JEDNOPOLNA 10AX 250V~	190
SE10--IN	SKLOPKA JEDNOPOLNA 10AX 250V~ IN	190
SE11--	TIPKALO JEDNOPOLNO 10A 250V~	190
SE11--TI50	TIPKALO JEDNOPOLNO 10A 250V~ TI 50	190
SE11--TI51	TIPKALO JEDNOPOLNO 10A 250V~ TI 51	190
SE11--IL	TIPKALO JEDNOPOLNO 10A 250V~ IL	190
SE22--IN03	SKLOPKA DVOPOLNA 10AX 250V~ IN 03	190
SE50--	SKLOPKA SERIJSKA JEDNOPOLNA 10AX 250V~	191
SE51--	TIPKALO SERIJSKO JEDNOPOLNO 10A 250V~	191
SE52--NT09	SKLOPKA ŽALUZIJSKA 10AX 250V~ NT 09	191
SE53--NT09	TIPKALO ŽALUZIJSKO 10A 250V~ NT 09	191
SE60--	SKLOPKA IZMJENIČNA 10AX 250V~	191
SE63--	SKLOPKA IZMJENIČNA DVOSTRUKA 10AX 250V~	191
SE70--	SKLOPKA KRIŽNA 10AX 250V~	191
TIPKE TE		
TE10--	TIPKA OBIČNA	192
TE10--IN	TIPKA INDIKATOR	192
TE13--IL	TIPKA S NATPISNOM PLOČICOM	192
TE11--	TIPKA SERIJSKA	192
INDIKACIJA IA		
IA10--	NEONSKA TINJALICA 230V~ 0,34W	193
IA20--	LED TINJALICA 230V~ AC/DC 0,40W	193
IA21--	LED TINJALICA 24V AC/DC 0,20W	193
IA22--	LED TINJALICA 12V AC/DC 0,10W	193
UTIČNICE VE		
VE10--XO	UTIČNICA ŠUKO 2P+E 16A 250V~ XO	196
VE11--XO	UTIČNICA ŠUKO+POKLOPAC 2P+E 16A 250V~ XO	196
VE12--XO	UTIČNICA ŠUKO 2P+E 16A 250V~ BV XO	196
VE13--XO	UTIČNICA ŠUKO+POKLOPAC 2P+E 16A 250V~ BV XO	196
VE10--	UTIČNICA ŠUKO 2P+E 16A 250V~	196
VE11--	UTIČNICA ŠUKO+POKLOPAC 2P+E 16A 250V~	196
VE12--	UTIČNICA ŠUKO 2P+E 16A 250V~ BV	196
VE13--	UTIČNICA ŠUKO+POKLOPAC 2P+E 16A 250V~ BV	196
VE40--XO	UTIČNICA FRANCUSKA 2P+E 16A 250V~ XO	197
VE41--XO	UTIČNICA FRANCUSKA+POKLOPAC 2P+E 16A 250V~ XO	197
VE42--XO	UTIČNICA FRANCUSKA 2P+E 16A 250V~ BV XO	197
VE43--XO	UTIČNICA FRANCUSKA+POKLOPAC 2P+E 16A 250V~ BV XO	197
VE40--	UTIČNICA FRANCUSKA 2P+E 16A 250V~	197
VE41--	UTIČNICA FRANCUSKA+POKLOPAC 2P+E 16A 250V~	197
VE42--	UTIČNICA FRANCUSKA 2P+E 16A 250V~ BV	197
VE43--	UTIČNICA FRANCUSKA+POKLOPAC 2P+E 16A 250V~ BV	197
VE16--	UTIČNICA ŠUKO DVOSTRUKA 2P+E 16A 250V~	198
VE46--	UTIČNICA FRANCUSKA DVOSTRUKA 2P+E 16A 250V~	198
VE30--	UTIČNICA 2P 16A 250V~	198
KOMUNIKACIJE KE		
KE11	UTIČNICA TV-R ZAVRŠNA 1dB	199
KE12	UTIČNICA TV-R PROLAZNA 10dB	199
KE16	UTIČNICA SAT-TV-R ZAVRŠNA 3dB	199
KE36	UTIČNICA TEL KS RJ11 6/4	199
KE37	UTIČNICA CAT5e KS RJ45 8/8	200
KE40	UTIČNICA CAT6s KS RJ45 8/8 SLIM	200
KE38	UTIČNICA TEL KS DVOSTRUKA 2x RJ11 6/4	200
KE39	UTIČNICA CAT5e KS DVOSTRUKA 2x RJ45 8/8	200
KE41	UTIČNICA CAT6s KS DVOSTRUKA 2x RJ45 8/8 SLIM	200
KE45	ADAPTER KS JEDNOSTRUKI	200
KE46	ADAPTER KS DVOSTRUKI	201
KE47	ADAPTER PD DVOSTRUKI	201
KE10--	UTIČNICA TV OSNOVNA 0dB	202
KE11--	UTIČNICA TV-R ZAVRŠNA 1dB	202
KE12--	UTIČNICA TV-R PROLAZNA 10dB	202
KE16--	UTIČNICA SAT-TV-R ZAVRŠNA 3dB	202
KE22--	UTIČNICA AUDIO 2xRCA	202
KE23--	UTIČNICA AUDIO ZVUČNICI	202
KE36--	UTIČNICA TEL KS RJ11 6/4	202
KE37--	UTIČNICA CAT5e KS RJ45 8/8	203
KE40--	UTIČNICA CAT6s KS RJ45 8/8 SLIM	203
KE38--	UTIČNICA TEL KS DVOSTRUKA 2x RJ11 6/4	203
KE39--	UTIČNICA CAT5e KS DVOSTRUKA 2x RJ45 8/8	203
KE41--	UTIČNICA CAT6s KS DVOSTRUKA 2x RJ45 8/8 SLIM	203
KE35--	UTIČNICA TEL LT RJ11 6/4	203

šifra	opis proizvoda	stranica
-------	----------------	----------

POKLOPCI ZA KOMUNIKACIJE PA

PE10--	POKLOPAC TV-R 2P/3P	204
PE20--	POKLOPAC KS JEDNOSTRUKI	204
PE21--	POKLOPAC KS DVOSTRUKI	204
PE30--	POKLOPAC TAE/TDO	204
PE32--	POKLOPAC IR SKLOPKA	204

ELEKTRONIKA EE

EE15	REGULATOR OSVJETLJENJA ROTACIJSKI IZMJENIČNI RL 400W	205
EE16	REGULATOR OSVJETLJENJA ROTACIJSKI IZMJENIČNI RLC 400W	205
EE19	REGULATOR OSVJETLJENJA ROTACIJSKI IZMJENIČNI LED 100W	206
EE15--	REGULATOR OSVJETLJENJA ROTACIJSKI IZMJENIČNI RL 400W	206
EE16--	REGULATOR OSVJETLJENJA ROTACIJSKI IZMJENIČNI RLC 400W	207
EE19--	REGULATOR OSVJETLJENJA ROTACIJSKI IZMJENIČNI LED 100W	207
EE32--	IR SKLOPKA 5A 230V~	207

POKLOPCI ELEKTRONIKE PE

PE41--	POKLOPAC REGULATOR OSVJETLJENJA Ø6	209
--------	------------------------------------	-----

PRIBOR AE

AE10--	SLIJEPI ELEMENT	210
AE20--	PRIKLJUČNA KUTIJA 5-POLNA 3P+N+E 5x4mm ²	210
AE30--	NADŽBUKNA KUTIJA 1	210
AE31--	NADŽBUKNA KUTIJA ZA DVOSTRUKU UTIČNICU EKONOMIK	210
AE50--	ZIDNI ŠTITNIK	211
AE51--	ZAŠTITA ZA DJECU KS	211

OKVIRI OE

OE10--	OKVIR EKONOMIK 1	212
OE20--	OKVIR EKONOMIK 2 VODORAVNI	212
OE21--	OKVIR EKONOMIK 2 OKOMITI	212
OE30--	OKVIR EKONOMIK 3 VODORAVNI	212
OE31--	OKVIR EKONOMIK 3 OKOMITI	213
OE40--	OKVIR EKONOMIK 4 VODORAVNI	213
OE41--	OKVIR EKONOMIK 4 OKOMITI	213
OE50--	OKVIR EKONOMIK 5 VODORAVNI	213
OE90--	DEKORATIVNI UMETCI U BOJI	214

fontana

šifra	opis proizvoda	stranica
-------	----------------	----------

SKLOPKE SF

SF10--	SKLOPKA JEDNOPOLNA IP44 10AX 250V~	218
SF10--TI	SKLOPKA JEDNOPOLNA IP44 10AX 250V~ TI	218
SF11--TI	TIPKALO JEDNOPOLNO IP44 10A 250V~ TI	218
SF20--	SKLOPKA DVOPOLNA IP44 10AX 250V~	218
SF50--	SKLOPKA SERIJSKA IP44 10AX 250V~	219
SF51--	TIPKALO SERIJSKO IP44 10A 250V~	219
SF60--	SKLOPKA IZMJENIČNA IP44 10AX 250V~	219
SF60--TI	SKLOPKA IZMJENIČNA IP44 10AX 250V~ TI	219
SF63--	SKLOPKA IZMJENIČNA DVOSTRUKA IP44 10AX 250V~	219
SF70--	SKLOPKA KRIŽNA IP44 10AX 250V~	219

UTIČNICE VF

VF10--	UTIČNICA ŠUKO+POKLOPAC IP44 2P+E 16A 250V~	220
VF12--	UTIČNICA ŠUKO+POKLOPAC IP44 2P+E 16A 250V~ BV	220

SETOVI CF

CF10--	SET ŠUKO UTIČNICA DVOSTRUKI VODORAVNI IP44 2x2P+E 16A 250V~	221
CF11--	SET ŠUKO UTIČNICA DVOSTRUKI OKOMITI IP44 2x2P+E 16A 250V~	221
CF12--	SET ŠUKO UTIČNICA + SKLOPKA IZMJENIČNA VODORAVNI IP44 16A + 10AX 250V~	221
CF13--	SET ŠUKO UTIČNICA + SKLOPKA IZMJENIČNA OKOMITI IP44 16A + 10AX 250V~	222
CF14--	SET ŠUKO UTIČNICA DVOSTRUKI VODORAVNI IP44 2x 2P+E 16A 250V~BV	222
CF15--	SET ŠUKO UTIČNICA DVOSTRUKI OKOMITI IP44 2x 2P+E 16A 250V~ BV	222
CF16--	SET UTIČNICA + SKLOPKA IZMJENIČNA VODORAVNI IP44 16A + 10AX 250V~ BV	222
CF17--	SET UTIČNICA SKLOPKA IZMJENIČNA OKOMITI IP44 16A + 10AX 250V~ BV	222

PRIBOR AF

AF10--	RAZDJELNI ORMARIĆ IP44 RN01	223
AF20--	RAZDJELNI ORMARIĆ IP55 ND01	223

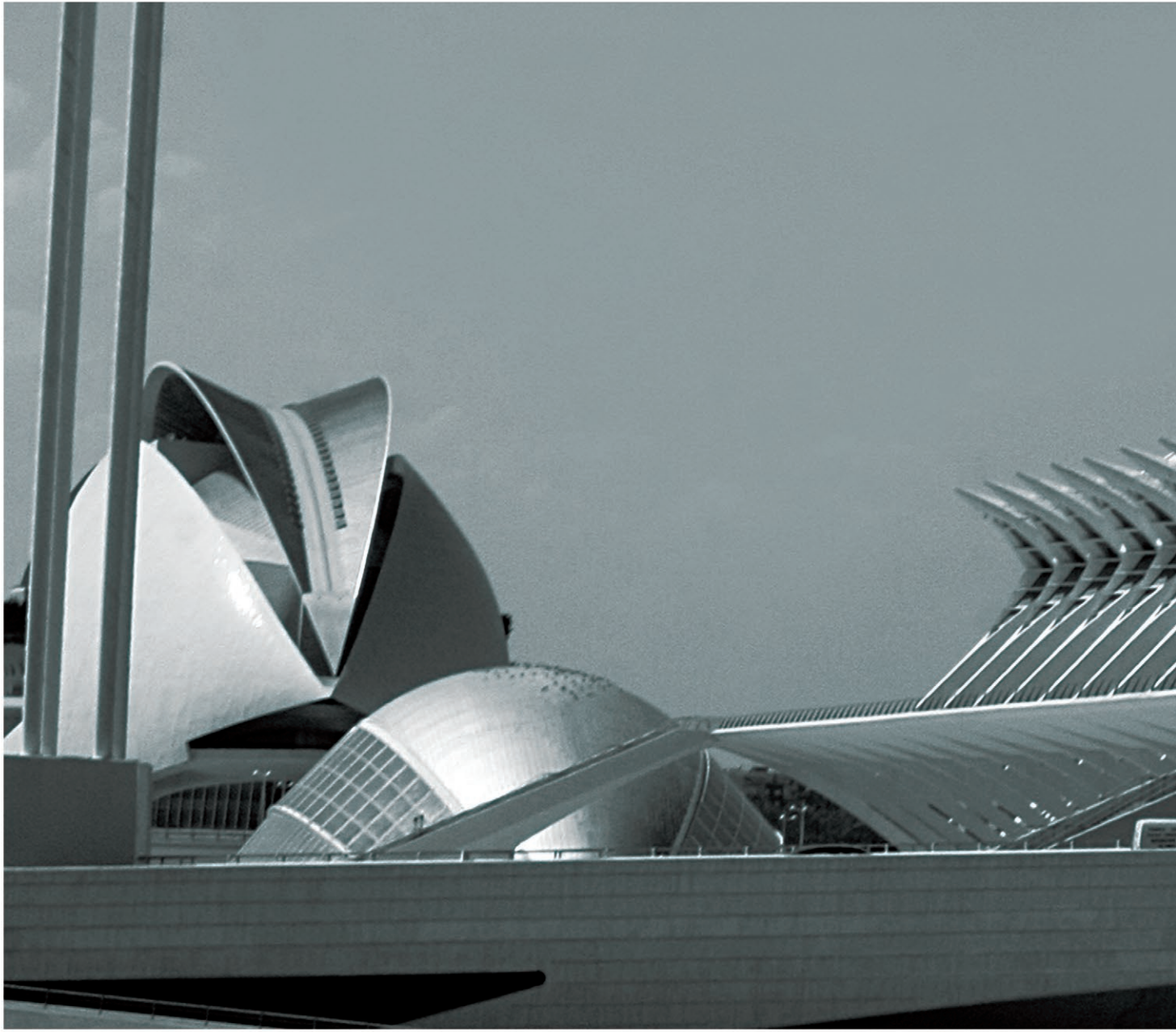

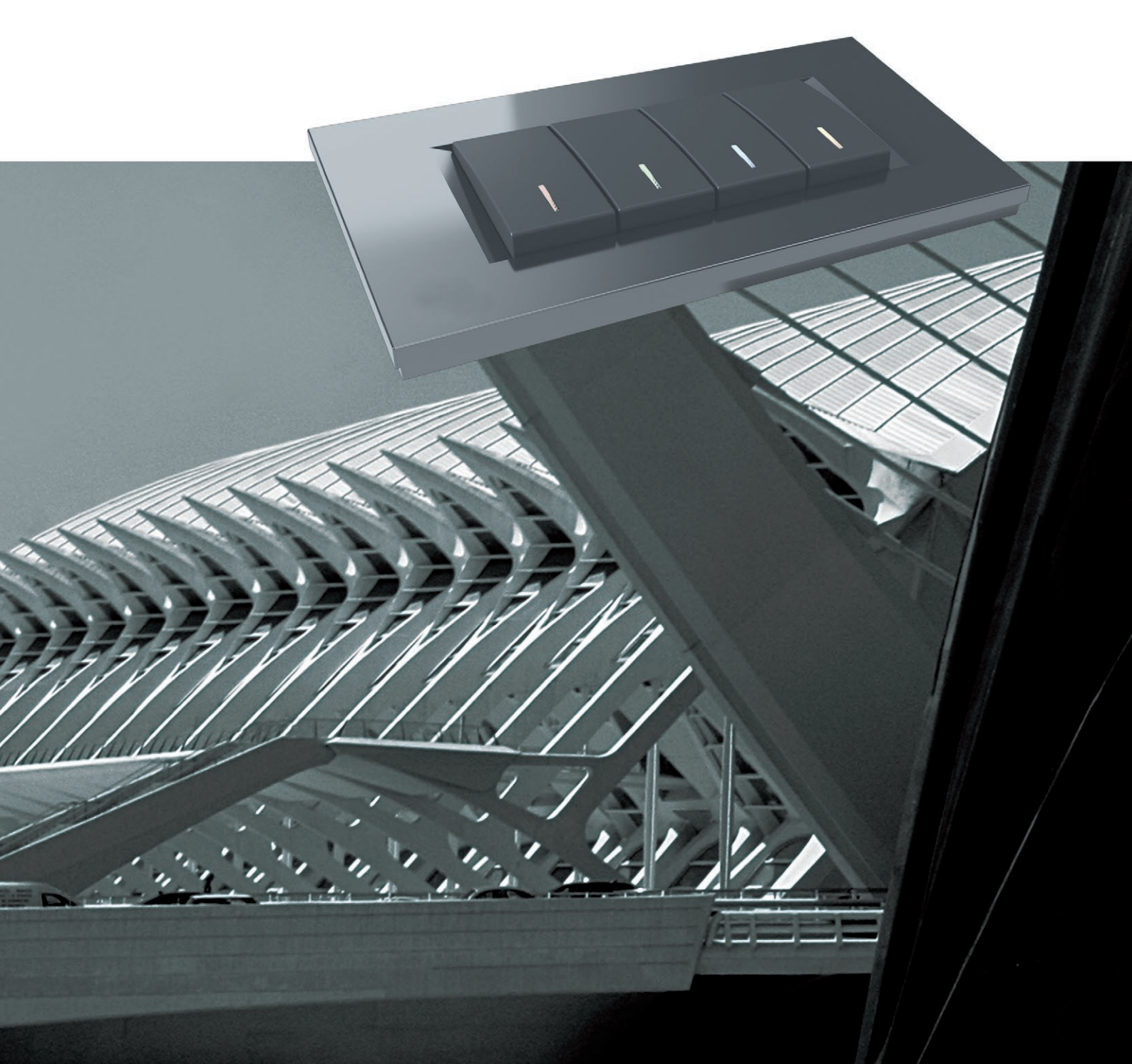

TEM

TEM ČATEŽ d.o.o.
Čatež 13, 8212 VELIKA LOKA
SLOVENIJA
tem@tem.si
www.tem.si
T +386(0)7 348 99 00



JVE